

## Chemicals

Ordered by Schedule and by CAS Registry Number or Key

**Chemical name:** 1-Isobutyl-3-methylbutyl isopropylphosphonofluoridate

Schedule: 1A01

CAS RN: HS code: 2931.39

Key: (108-82-7)-I1A1

Molecular formula: C<sub>12</sub>H<sub>26</sub>FO<sub>2</sub>P

CAS Index Name: Phosphonofluoric acid, 1-methylethyl-, 1-isobutyl-3-methylbutyl ester

**IUPAC name:** 1-Isobutyl-3-methylbutyl isopropylphosphonofluoridoate

Synonyms: Phosphonofluoric acid, 1-methylethyl-, 2,6-dimethylhept-4-yl ester

O-1-Isobutyl-3-methylbutyl isopropylphosphonofluoridate

2,6-Dimethylheptan-4-yl 1-methylethylphosphonofluoridate

2,6-Dimethylhept-4-yl 1-methylethylphosphonofluoridate

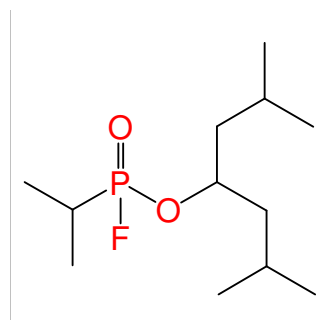

**Chemical name:** 1-Isobutyl-3-methylbutyl propylphosphonofluoridate

Schedule: 1A01

CAS RN: HS code: 2931.39

Key: (108-82-7)-P1A1

Molecular formula: C<sub>12</sub>H<sub>26</sub>FO<sub>2</sub>P

CAS Index Name: Phosphonofluoric acid, propyl-, 1-isobutyl-3-methylbutyl ester

**IUPAC name:** 1-Isobutyl-3-methylbutyl propylphosphonofluoridoate

Synonyms: Phosphonofluoric acid, propyl-, 2,6-dimethylhept-4-yl ester

O-1-Isobutyl-3-methylbutyl propylphosphonofluoridate

2,6-Dimethylheptan-4-yl propylphosphonofluoridate

2,6-Dimethylhept-4-yl propylphosphonofluoridate

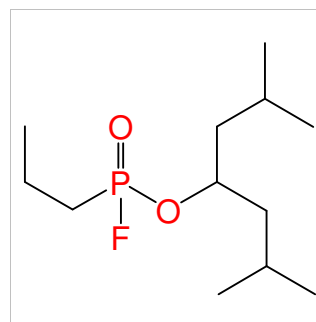

**Chemical name:** Cyclohexyl methyl-d3-phosphonofluoridate

Schedule: 1A01

CAS RN: HS code: 2845.90

Key: (108-93-0)-M1A1(D3)

Molecular formula: C<sub>7</sub>H<sub>11</sub>D<sub>3</sub>FO<sub>2</sub>P

CAS Index Name: Phosphonofluoric acid, methyl-d<sub>3</sub>-, cyclohexyl ester

**IUPAC name:** Cyclohexyl methyl-d<sub>3</sub>-phosphonofluoridoate

Synonyms: O-Cyclohexyl trideuteriomethylphosphonofluoridate

O-Cyclohexyl methyl-d<sub>3</sub>-phosphonofluoridate

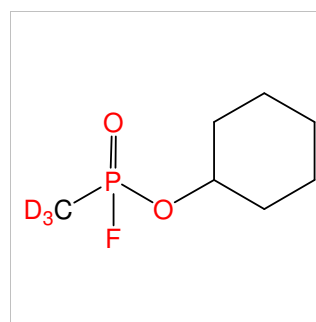

**Chemical name:** 1-Methylnonyl propylphosphonofluoridate

Schedule: 1A01

CAS RN: HS code: 2931.39

Key: (1120-06-5)-P1A1

Molecular formula: C<sub>13</sub>H<sub>28</sub>FO<sub>2</sub>P

CAS Index Name: Phosphonofluoridic acid, propyl-, dec-2-yl ester

**IUPAC name:** 1-Methylnonyl propylphosphonofluoridoate

Synonyms: O-1-Methylnonyl propylphosphonofluoridate

Decan-2-yl propylphosphonofluoridate

Dec-2-yl propylphosphonofluoridate

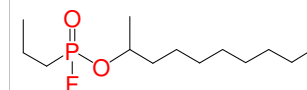

**Chemical name:** 3-Cyclohexylpropyl isopropylphosphonofluoridate

Schedule: 1A01

CAS RN: HS code: 2931.39

Key: (1124-63-6)-I1A1

Molecular formula: C<sub>12</sub>H<sub>24</sub>FO<sub>2</sub>P

CAS Index Name: Phosphonofluoridic acid, 1-methylethyl-, 3-cyclohexylpropyl ester

**IUPAC name:** 3-Cyclohexylpropyl isopropylphosphonofluoridoate

Synonyms: O-3-Cyclohexylpropyl isopropylphosphonofluoridate

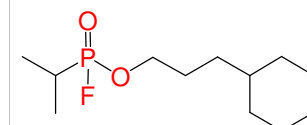

**Chemical name:** 1-Cyclohexylethyl isopropylphosphonofluoridate

Schedule: 1A01

CAS RN: HS code: 2931.39

Key: (1193-81-3)-I1A1

Molecular formula: C<sub>11</sub>H<sub>22</sub>FO<sub>2</sub>P

CAS Index Name: Phosphonofluoridic acid, 1-methylethyl-, 1-cyclohexylethyl ester

**IUPAC name:** 1-Cyclohexylethyl isopropylphosphonofluoridoate

Synonyms: O-1-Cyclohexylethyl 1-methylethyl-phosphonofluoridate

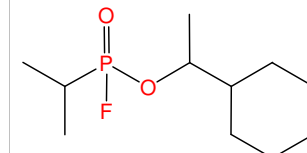

**Chemical name:** (S)-2-Methylbutyl methylphosphonofluoridate

Schedule: 1A01

CAS RN: HS code: 2931.39

Key: (137-32-6)-M1A1(S)

Molecular formula: C<sub>6</sub>H<sub>14</sub>FO<sub>2</sub>P

CAS Index Name: Phosphonofluoridic acid, methyl-, 2-methylbutyl ester,(S)-

**IUPAC name:** (S)-2-Methylbutyl methylphosphonofluoridoate

Synonyms: (S)-O-2-Methylbutyl methylphosphonofluoridate

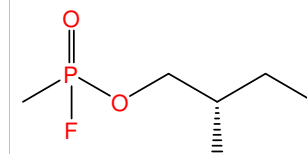

**Chemical name:** 1-Ethyl-2-methylpentyl isopropylphosphonofluoridate

Schedule: 1A01

CAS RN: HS code: 2931.39

Key: (14979-39-6)-I1A1

Molecular formula: C<sub>11</sub>H<sub>24</sub>FO<sub>2</sub>P

CAS Index Name: Phosphonofluoric acid, 1-methylethyl-, 1-ethyl-2-methylpentyl ester

**IUPAC name:** 1-Ethyl-2-methylpentyl isopropylphosphonofluoridoate

Synonyms: O-1-Ethyl-2-methylpentyl isopropylphosphonofluoridate

4-Methylheptan-3-yl isopropylphosphonofluoridate

4-Methylhept-3-yl isopropylphosphonofluoridate

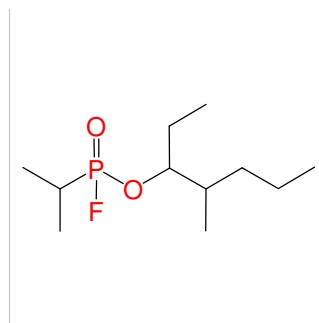

**Chemical name:** 2,3-Dimethylcyclohexyl ethylphosphonofluoridate

Schedule: 1A01

CAS RN: HS code: 2931.39

Key: (1502-24-5)-E1A1

Molecular formula: C<sub>10</sub>H<sub>20</sub>FO<sub>2</sub>P

CAS Index Name: Phosphonofluoric acid, ethyl-, 2,3-dimethylcyclohexyl ester

**IUPAC name:** 2,3-Dimethylcyclohexyl ethylphosphonofluoridoate

Synonyms: O-2,3-Dimethylcyclohexyl ethylphosphonofluoridate

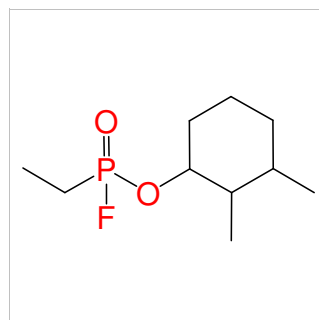

**Chemical name:** 2,3-Dimethylcyclohexyl isopropylphosphonofluoridate

Schedule: 1A01

CAS RN: HS code: 2931.39

Key: (1502-24-5)-I1A1

Molecular formula: C<sub>11</sub>H<sub>22</sub>FO<sub>2</sub>P

CAS Index Name: Phosphonofluoric acid, 1-methylethyl-, 2,3-dimethylcyclohexyl ester

**IUPAC name:** 2,3-Dimethylcyclohexyl isopropylphosphonofluoridoate

Synonyms: O-2,3-Dimethylcyclohexyl isopropylphosphonofluoridate

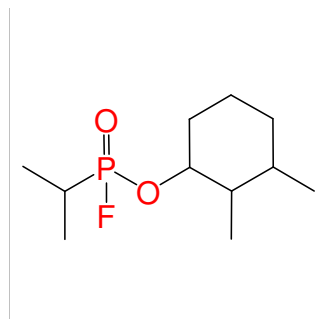

**Chemical name:** 2,3-Dimethylcyclohexyl methylphosphonofluoridate

Schedule: 1A01

CAS RN: HS code: 2931.39

Key: (1502-24-5)-M1A1

Molecular formula: C<sub>9</sub>H<sub>18</sub>FO<sub>2</sub>P

CAS Index Name: Phosphonofluoridic acid, methyl-, 2,3-dimethylcyclohexyl ester

**IUPAC name:** 2,3-Dimethylcyclohexyl methylphosphonofluoridoate

Synonyms: O-2,3-Dimethylcyclohexyl methylphosphonofluoridate

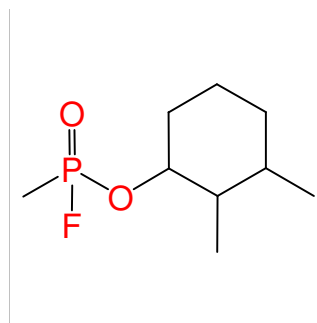

**Chemical name:** 3-Methylcyclopentyl isopropylphosphonofluoridate

Schedule: 1A01

CAS RN: HS code: 2931.39

Key: (18729-48-1)-I1A1

Molecular formula: C<sub>9</sub>H<sub>18</sub>FO<sub>2</sub>P

CAS Index Name: Phosphonofluoridic acid, 1-methylethyl-, 3-methylcyclopentyl ester

**IUPAC name:** 3-Methylcyclopentyl isopropylphosphonofluoridoate

Synonyms: O-3-Methylcyclopentyl isopropylphosphonofluoridate

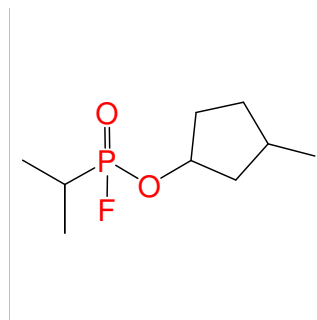

**Chemical name:** 3-Methylcyclopentyl methylphosphonofluoridate

Schedule: 1A01

CAS RN: HS code: 2931.39

Key: (18729-48-1)-M1A1

Molecular formula: C<sub>7</sub>H<sub>14</sub>FO<sub>2</sub>P

CAS Index Name: Phosphonofluoridic acid, methyl-, 3-methylcyclopentyl ester

**IUPAC name:** 3-Methylcyclopentyl methylphosphonofluoridoate

Synonyms: O-3-Methylcyclopentyl methylphosphonofluoridate

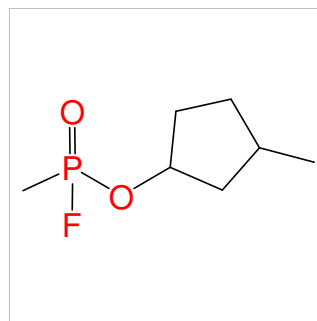

**Chemical name:** 3-Methylcyclopentyl propylphosphonofluoridate

Schedule: 1A01

CAS RN: HS code: 2931.39

Key: (18729-48-1)-P1A1

Molecular formula: C<sub>9</sub>H<sub>18</sub>FO<sub>2</sub>P

CAS Index Name:

**IUPAC name:**

Synonyms:

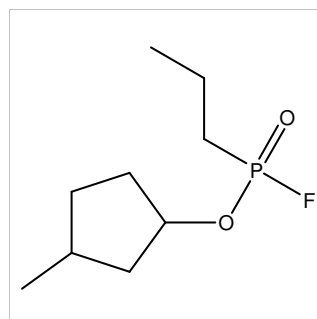

**Chemical name:** 1-Ethylhexyl ethylphosphonofluoridate

Schedule: 1A01

CAS RN: HS code: 2931.39

Key: (20296-29-1)-E1A1

Molecular formula: C<sub>10</sub>H<sub>22</sub>FO<sub>2</sub>P

CAS Index Name: Phosphonofluoridic acid, ethyl-, 1-ethylhexyl ester

**IUPAC name:** 1-Ethylhexyl ethylphosphonofluoridoate

Synonyms: Phosphonofluoridic acid, ethyl-, oct-3-yl ester

Octan-3-yl ethylphosphonofluoridate

Oct-3-yl ethylphosphonofluoridate

O-1-Ethylhexyl ethylphosphonofluoridate

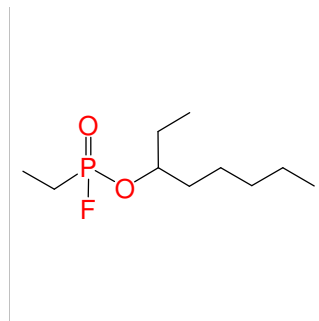

**Chemical name:** 1-Propylheptyl isopropylphosphonofluoridate

Schedule: 1A01

CAS RN: HS code: 2931.39

Key: (2051-31-2)-I1A1

Molecular formula: C<sub>13</sub>H<sub>28</sub>FO<sub>2</sub>P

CAS Index Name:

**IUPAC name:**

Synonyms:

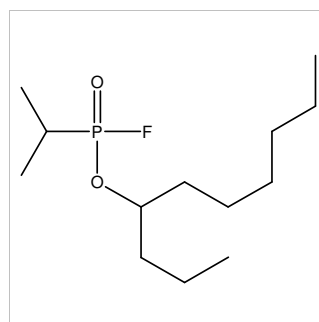

**Chemical name:** 1-Propylheptyl propylphosphonofluoridate

Schedule: 1A01

CAS RN: HS code: 2931.39

Key: (2051-31-2)-P1A1

Molecular formula: C<sub>13</sub>H<sub>28</sub>FO<sub>2</sub>P

CAS Index Name:

**IUPAC name:**

Synonyms:

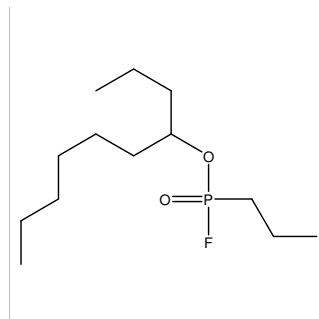

**Chemical name:** 2-Methylcyclopentyl methylphosphonofluoridate

Schedule: 1A01

CAS RN: HS code: 2931.39

Key: (24070-77-7)-M1A1

Molecular formula: C<sub>7</sub>H<sub>14</sub>FO<sub>2</sub>P

CAS Index Name: Phosphonofluoridic acid, methyl-, 2-methylcyclopentyl ester

**IUPAC name:** 2-Methylcyclopentyl methylphosphonofluoridoate

Synonyms: O-2-Methylcyclopentyl methylphosphonofluoridate

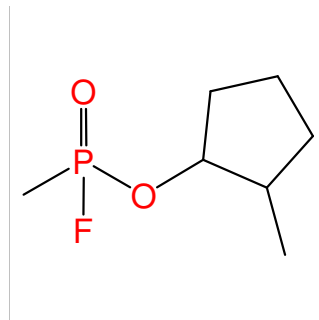

**Chemical name:** Cyclopropylmethyl ethylphosphonofluoridate

Schedule: 1A01

CAS RN: HS code: 2931.39

Key: (2516-33-8)-E1A1

Molecular formula: C<sub>6</sub>H<sub>12</sub>FO<sub>2</sub>P

CAS Index Name:

**IUPAC name:**

Synonyms:

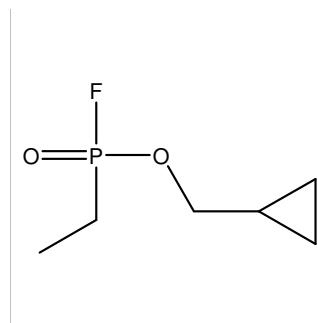

**Chemical name:** Cyclopropylmethyl isopropylphosphonofluoridate

Schedule: 1A01

CAS RN: HS code: 2931.39

Key: (2516-33-8)-I1A1

Molecular formula: C<sub>7</sub>H<sub>14</sub>FO<sub>2</sub>P

CAS Index Name: Phosphonofluoridic acid, 1-methylethyl-, cyclopropylmethyl ester

**IUPAC name:** Cyclopropylmethyl isopropylphosphonofluoridoate

Synonyms: O-Cyclopropylmethyl isopropylphosphonofluoridate

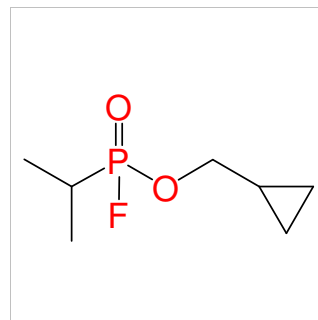

**Chemical name:** Cyclopropylmethyl methylphosphonofluoridate

Schedule: 1A01

CAS RN: HS code: 2931.39

Key: (2516-33-8)-M1A1

Molecular formula: C<sub>5</sub>H<sub>10</sub>FO<sub>2</sub>P

CAS Index Name:

**IUPAC name:**

Synonyms:

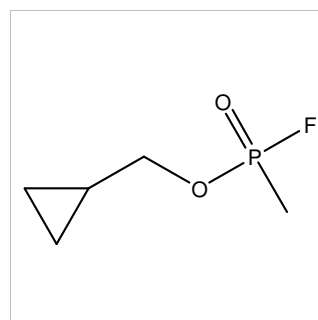

**Chemical name:** Cyclopropylmethyl propylphosphonofluoridate

Schedule: 1A01

CAS RN: HS code: 2931.39

Key: (2516-33-8)-P1A1

Molecular formula: C<sub>7</sub>H<sub>14</sub>FO<sub>2</sub>P

CAS Index Name:

**IUPAC name:**

Synonyms:

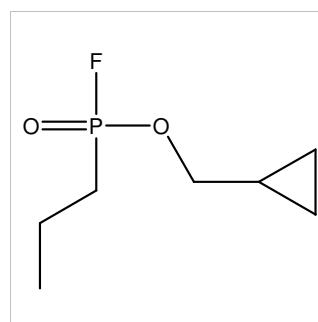

**Chemical name:** 3,5,5-Trimethylhexyl isopropylphosphonofluoridate

Schedule: 1A01

CAS RN: HS code: 2931.39

Key: (3452-97-9)-I1A1

Molecular formula: C<sub>12</sub>H<sub>26</sub>FO<sub>2</sub>P

CAS Index Name: Phosphonofluoric acid, 1-methylethyl-, 3,5,5-trimethylhexyl ester

**IUPAC name:** 3,5,5-Trimethylhexyl isopropylphosphonofluoridate

Synonyms: O-3,5,5-Trimethylhexyl isopropylphosphonofluoridate

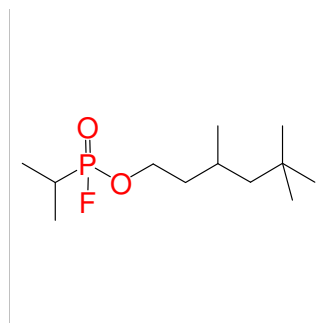

**Chemical name:** 3,5,5-Trimethylhexyl propylphosphonofluoridate

Schedule: 1A01

CAS RN: HS code: 2931.39

Key: (3452-97-9)-P1A1

Molecular formula: C<sub>12</sub>H<sub>26</sub>FO<sub>2</sub>P

CAS Index Name: Phosphonofluoric acid, propyl-, 3,5,5-trimethylhexyl ester

**IUPAC name:** 3,5,5-Trimethylhexyl propylphosphonofluoridate

Synonyms: O-3,5,5-Trimethylhexyl propylphosphonofluoridate

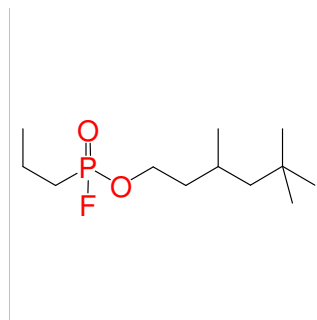

**Chemical name:** Cyclopentylmethyl isopropylphosphonofluoridate

Schedule: 1A01

CAS RN: HS code: 2931.39

Key: (3637-61-4)-I1A1

Molecular formula: C<sub>9</sub>H<sub>18</sub>FO<sub>2</sub>P

CAS Index Name: Phosphonofluoric acid, 1-methylethyl-, cyclopentylmethyl ester

**IUPAC name:** Cyclopentylmethyl isopropylphosphonofluoridate

Synonyms: O-Cyclopentylmethyl isopropylphosphonofluoridate

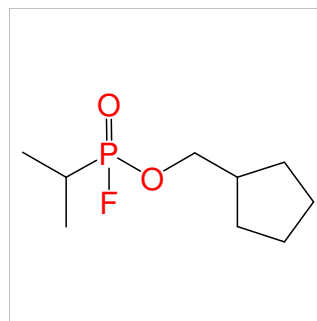

**Chemical name:** Cyclopentylmethyl methylphosphonofluoridate

Schedule: 1A01

CAS RN: HS code: 2931.39

Key: (3637-61-4)-M1A1

Molecular formula: C<sub>7</sub>H<sub>14</sub>FO<sub>2</sub>P

CAS Index Name: Phosphonofluoric acid, methyl-, cyclopentylmethyl ester

**IUPAC name:** Cyclopentylmethyl methylphosphonofluoridate

Synonyms: O-Cyclopentylmethyl methylphosphonofluoridate

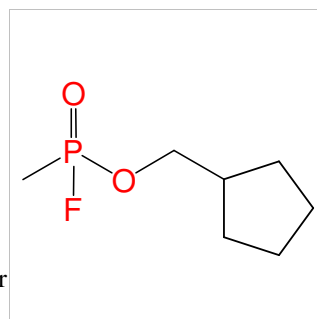

**Chemical name:** Cyclopentylmethyl propylphosphonofluoridate

Schedule: 1A01

CAS RN: HS code: 2931.39

Key: (3637-61-4)-P1A1

Molecular formula: C<sub>9</sub>H<sub>18</sub>FO<sub>2</sub>P

CAS Index Name: Phosphonofluoridic acid, propyl-, cyclopentylmethyl ester

**IUPAC name:** Cyclopentylmethyl propylphosphonofluoridoate

Synonyms: O-Cyclopentylmethyl propylphosphonofluoridate

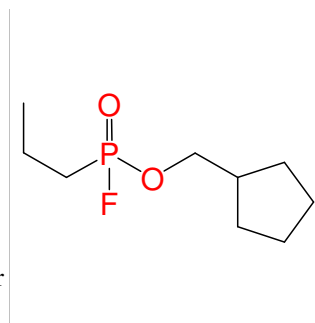

**Chemical name:** 2-Ethylcyclohexyl ethylphosphonofluoridate

Schedule: 1A01

CAS RN: HS code: 2931.39

Key: (3760-20-1)-E1A1

Molecular formula: C<sub>10</sub>H<sub>20</sub>FO<sub>2</sub>P

CAS Index Name: Phosphonofluoridic acid, ethyl-, 2-ethylcyclohexyl ester

**IUPAC name:** 2-Ethylcyclohexyl ethylphosphonofluoridoate

Synonyms: O-2-Ethylcyclohexyl ethylphosphonofluoridate

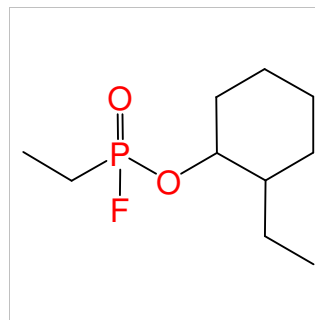

**Chemical name:** 2-Ethylcyclohexyl isopropylphosphonofluoridate

Schedule: 1A01

CAS RN: HS code: 2931.39

Key: (3760-20-1)-I1A1

Molecular formula: C<sub>11</sub>H<sub>22</sub>FO<sub>2</sub>P

CAS Index Name: Phosphonofluoridic acid, 1-methylethyl-, 2-ethylcyclohexyl ester

**IUPAC name:** 2-Ethylcyclohexyl isopropylphosphonofluoridoate

Synonyms: O-2-Ethylcyclohexyl isopropylphosphonofluoridate

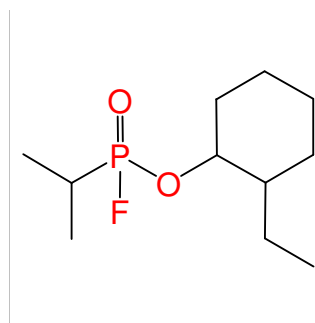

**Chemical name:** 2-Ethylcyclohexyl propylphosphonofluoridate

Schedule: 1A01

CAS RN: HS code: 2931.39

Key: (3760-20-1)-P1A1

Molecular formula: C<sub>11</sub>H<sub>22</sub>FO<sub>2</sub>P

CAS Index Name: Phosphonofluoridic acid, propyl-, 2-ethylcyclohexyl ester

**IUPAC name:** 2-Ethylcyclohexyl propylphosphonofluoridoate

Synonyms: O-2-Ethylcyclohexyl propylphosphonofluoridate

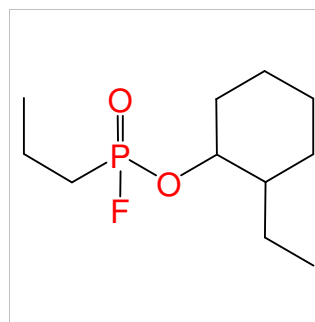



**Chemical name:** 2,5-Dimethylcyclohexyl methylphosphonofluoridate

Schedule: 1A01

CAS RN: HS code: 2931.39

Key: (3809-32-3)-M1A1

Molecular formula: C<sub>9</sub>H<sub>18</sub>FO<sub>2</sub>P

CAS Index Name: Phosphonofluoridic acid, methyl-, 2,5-dimethylcyclohexyl ester

**IUPAC name:** 2,5-Dimethylcyclohexyl methylphosphonofluoridoate

Synonyms: O-2,5-Dimethylcyclohexyl methylphosphonofluoridate

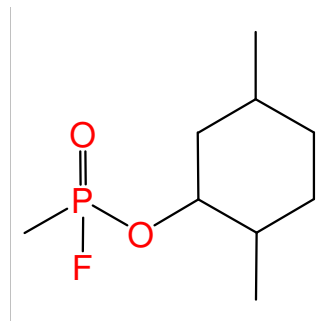

**Chemical name:** 4-Cyclohexylbutyl ethylphosphonofluoridate

Schedule: 1A01

CAS RN: HS code: 2931.39

Key: (4441-57-0)-E1A1

Molecular formula: C<sub>12</sub>H<sub>24</sub>FO<sub>2</sub>P

CAS Index Name:

**IUPAC name:**

Synonyms:

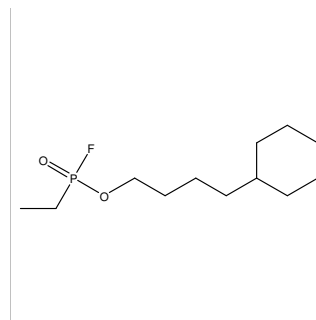

**Chemical name:** 4-Cyclohexylbutyl isopropylphosphonofluoridate

Schedule: 1A01

CAS RN: HS code: 2931.39

Key: (4441-57-0)-I1A1

Molecular formula: C<sub>13</sub>H<sub>26</sub>FO<sub>2</sub>P

CAS Index Name:

**IUPAC name:**

Synonyms:

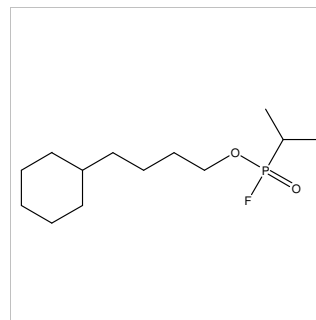

**Chemical name:** 4-Cyclohexylbutyl methylphosphonofluoridate

Schedule: 1A01

CAS RN: HS code: 2931.39

Key: (4441-57-0)-M1A1

Molecular formula: C<sub>11</sub>H<sub>22</sub>FO<sub>2</sub>P

CAS Index Name: Phosphonofluoridic acid, methyl-, 4-cyclohexylbutyl ester

**IUPAC name:** 4-Cyclohexylbutyl methylphosphonofluoridoate

Synonyms: O-4-Cyclohexylbutyl methylphosphonofluoridate

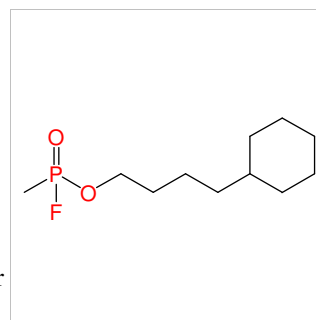

**Chemical name:** 4-Cyclohexylbutyl propylphosphonofluoridate

Schedule: 1A01

CAS RN: HS code: 2931.39

Key: (4441-57-0)-P1A1

Molecular formula: C<sub>13</sub>H<sub>26</sub>FO<sub>2</sub>P

CAS Index Name:

**IUPAC name:**

Synonyms:

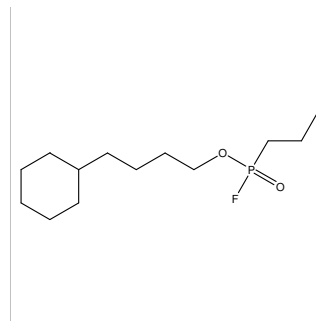

**Chemical name:** 2-Cyclohexylethyl isopropylphosphonofluoridate

Schedule: 1A01

CAS RN: HS code: 2931.39

Key: (4442-79-9)-I1A1

Molecular formula: C<sub>11</sub>H<sub>22</sub>FO<sub>2</sub>P

CAS Index Name: Phosphonofluoridic acid, 1-methylethyl-, 2-cyclohexylethyl ester

**IUPAC name:** 2-Cyclohexylethyl isopropylphosphonofluoridoate

Synonyms: O-2-Cyclohexylethyl isopropylphosphonofluoridate

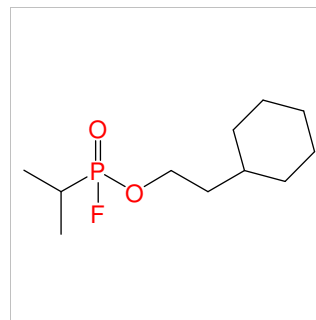

**Chemical name:** [14C]-Pinacolyl methylphosphonofluoridate

Schedule: 1A01

CAS RN: HS code: 2845.90

Key: (464-07-3)[14C]-M1A1

Molecular formula: C<sub>7-x</sub> 14C<sub>x</sub> H<sub>16</sub>FO<sub>2</sub>P

CAS Index Name: Phosphonofluoridic acid, methyl-, 1,2,2-trimethylpropyl-14C<sub>x</sub> ester

**IUPAC name:** (14C)1,2,2-Trimethylpropyl methylphosphonofluoridoate

Synonyms: O-[14C]-Pinacolyl methylphosphonofluoridate

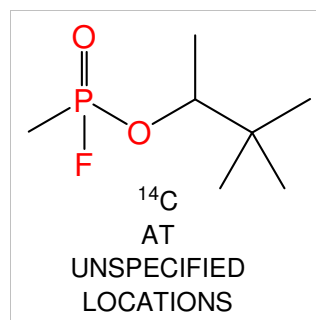

**Chemical name:** Pinacolyl-dx-methylphosphonofluoridate

Schedule: 1A01

CAS RN: HS code: 2845.90

Key: (464-07-3)-M1A1

Molecular formula: C<sub>7</sub>H<sub>16</sub>-xD<sub>x</sub>FO<sub>2</sub>P

CAS Index Name: Phosphonofluoridic acid, methyl-, 1,2,2-trimethylpropyl-dx ester

**IUPAC name:** 1,2,2-Trimethylpropyl-dx methylphosphonofluoridoate

Synonyms: O-Pinacolyl-dx-methylphosphonofluoridate

O-3,3-Dimethylbut-2-yl-dx methylphosphonofluoridate

O-1,2,2-Trimethylpropyl-dx methylphosphonofluoridate

3,3-Dimethylbutan-2-yl-dx methylphosphonofluoridate

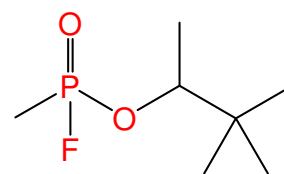

DEUTERIUM  
AT  
UNSPECIFIED  
LOCATIONS

**Chemical name:** Pinacolyl methylphosphonofluoridate(-)

Schedule: 1A01

CAS RN: HS code: 2931.39

Key: (464-07-3)-M1A1-C(-)

Molecular formula: C<sub>7</sub>H<sub>16</sub>FO<sub>2</sub>P

CAS Index Name: Phosphonofluoridic acid, methyl-, 1,2,2-trimethylpropyl ester, (-)

**IUPAC name:** 1,2,2-Trimethylpropyl methylphosphonofluoridoate(-)

Synonyms: (-)Pinacolyl methylphosphonofluoridate

(-)-3,3-Dimethylbutan-2-yl methylphosphonofluoridate

(-)-3,3-Dimethylbut-2-yl methylphosphonofluoridate

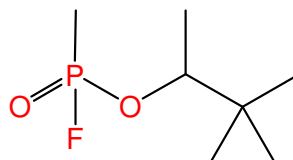

**Chemical name:** 1,5-Dimethylhexyl ethylphosphonofluoridate

Schedule: 1A01

CAS RN: HS code: 2931.39

Key: (4730-22-7)-E1A1

Molecular formula: C<sub>10</sub>H<sub>22</sub>FO<sub>2</sub>P

CAS Index Name: Phosphonofluoridic acid, ethyl-, 1,5-dimethylhexyl ester

**IUPAC name:** 1,5-Dimethylhexyl ethylphosphonofluoridoate

Synonyms: Phosphonofluoridic acid, ethyl-, 6-methylhept-2-yl ester

O-1,5-Dimethylhexyl ethylphosphonofluoridate

6-Methylheptan-2-yl ethylphosphonofluoridate

6-Methylhept-2-yl ethylphosphonofluoridate

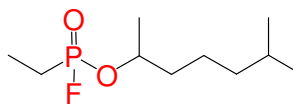

**Chemical name:** 1,5-Dimethylhexyl isopropylphosphonofluoridate

Schedule: 1A01

CAS RN: HS code: 2931.39

Key: (4730-22-7)-I1A1

Molecular formula: C<sub>11</sub>H<sub>24</sub>FO<sub>2</sub>P

CAS Index Name: Phosphonofluoridic acid, 1-methylethyl-, 1,5-dimethylhexyl ester

**IUPAC name:** 1,5-Dimethylhexyl isopropylphosphonofluoridoate

Synonyms: Phosphonofluoridic acid, 1-methylethyl-, 6-methylhept-2-yl ester

O-1,5-Dimethylhexyl isopropylphosphonofluoridate

6-Methylheptan-2-yl 1-methylethylphosphonofluoridate

6-Methylhept-2-yl 1-methylethylphosphonofluoridate

1,5-Dimethylhexyl (1-methylethyl)phosphonofluoridate

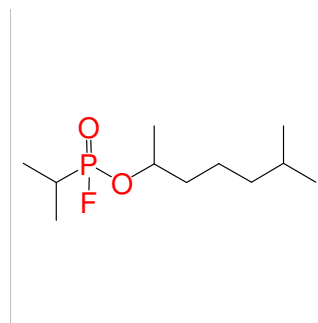

**Chemical name:** 1,5-Dimethylhexyl propylphosphonofluoridate

Schedule: 1A01

CAS RN: HS code: 2931.39

Key: (4730-22-7)-P1A1

Molecular formula: C<sub>11</sub>H<sub>24</sub>FO<sub>2</sub>P

CAS Index Name: Phosphonofluoridic acid, propyl-, 1,5-dimethylhexyl ester

**IUPAC name:** 1,5-Dimethylhexyl propylphosphonofluoridoate

Synonyms: Phosphonofluoridic acid, propyl-, 6-methylhept-2-yl ester

O-1,5-Dimethylhexyl propylphosphonofluoridate

6-Methylheptan-2-yl propylphosphonofluoridate

6-Methylhept-2-yl propylphosphonofluoridate

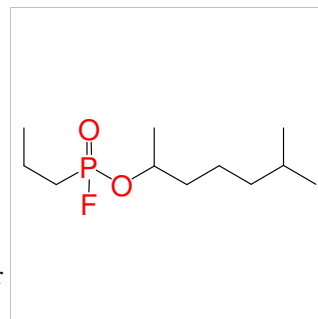

**Chemical name:** 2-Norbornanemethyl ethylphosphonofluoridate

Schedule: 1A01

CAS RN: HS code: 2931.39

Key: (5240-72-2)-E1A1

Molecular formula: C<sub>10</sub>H<sub>18</sub>FO<sub>2</sub>P

CAS Index Name:

**IUPAC name:**

Synonyms: 2-Norbornylmethyl ethylphosphonofluoridate

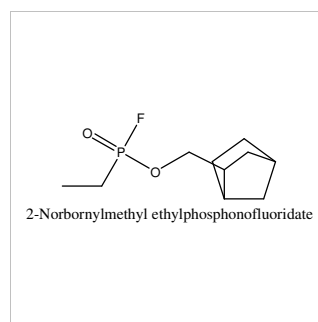

**Chemical name:** 2-Norbornanemethyl isopropylphosphonofluoridate

Schedule: 1A01

CAS RN: HS code: 2931.39

Key: (5240-72-2)-I1A1

Molecular formula: C<sub>11</sub>H<sub>20</sub>FO<sub>2</sub>P

CAS Index Name:

**IUPAC name:**

Synonyms: 2-Norbornylmethyl isopropylphosphonofluoridate

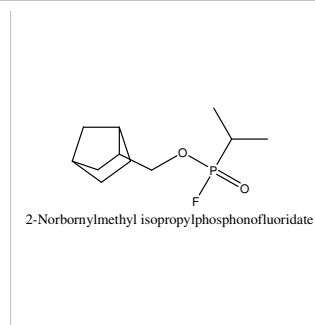

**Chemical name:** 2-Norbornanemethyl methylphosphonofluoridate

Schedule: 1A01

CAS RN: HS code: 2931.39

Key: (5240-72-2)-M1A1

Molecular formula: C<sub>9</sub>H<sub>16</sub>FO<sub>2</sub>P

CAS Index Name:

**IUPAC name:**

Synonyms:

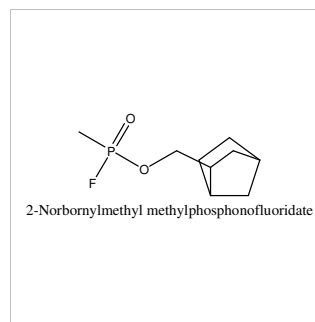

**Chemical name:** 2-Norbornanemethyl propylphosphonofluoridate

Schedule: 1A01

CAS RN: HS code: 2931.39

Key: (5240-72-2)-P1A1

Molecular formula: C<sub>11</sub>H<sub>20</sub>FO<sub>2</sub>P

CAS Index Name:

**IUPAC name:**

Synonyms: 2-Norbornylmethyl propylphosphonofluoridate

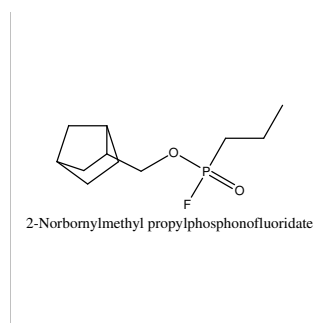

**Chemical name:** 1-Cyclopentylethyl methylphosphonofluoridate

Schedule: 1A01

CAS RN: HS code: 2931.39

Key: (52829-98-8)-M1A1

Molecular formula: C<sub>8</sub>H<sub>16</sub>FO<sub>2</sub>P

CAS Index Name:

**IUPAC name:**

Synonyms:

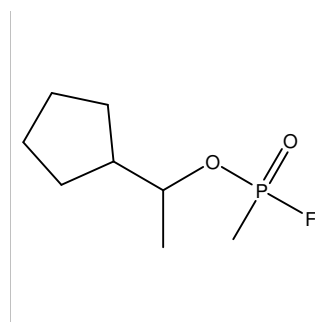

**Chemical name:** 2,6-Dimethylcyclohexyl ethylphosphonofluoridate

Schedule: 1A01

CAS RN: HS code: 2931.39

Key: (5337-72-4)-E1A1

Molecular formula: C<sub>10</sub>H<sub>20</sub>FO<sub>2</sub>P

CAS Index Name: Phosphonofluoridic acid, ethyl-, 2,6-dimethylcyclohexyl ester

**IUPAC name:** 2,6-Dimethylcyclohexyl ethylphosphonofluoridoate

Synonyms: O-2,6-Dimethylcyclohexyl ethylphosphonofluoridate

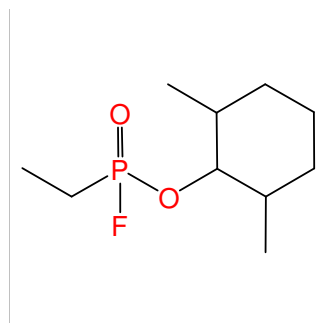

**Chemical name:** 2,6-Dimethylcyclohexyl isopropylphosphonofluoridate

Schedule: 1A01

CAS RN: HS code: 2931.39

Key: (5337-72-4)-I1A1

Molecular formula: C<sub>11</sub>H<sub>22</sub>FO<sub>2</sub>P

CAS Index Name: Phosphonofluoridic acid, 1-methylethyl-, 2,6-dimethylcyclohexyl ester

**IUPAC name:** 2,6-Dimethylcyclohexyl isopropylphosphonofluoridoate

Synonyms: O-2,6-Dimethylcyclohexyl isopropylphosphonofluoridate

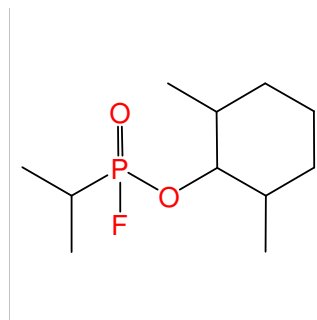

**Chemical name:** 2,6-Dimethylcyclohexyl propylphosphonofluoridate

Schedule: 1A01

CAS RN: HS code: 2931.39

Key: (5337-72-4)-P1A1

Molecular formula: C<sub>11</sub>H<sub>22</sub>FO<sub>2</sub>P

CAS Index Name: Phosphonofluoridic acid, propyl-, 2,6-dimethylcyclohexyl ester

**IUPAC name:** 2,6-Dimethylcyclohexyl propylphosphonofluoridoate

Synonyms: O-2,6-Dimethylcyclohexyl propylphosphonofluoridate

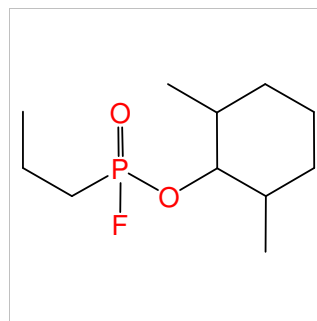

**Chemical name:** 3,5-Dimethylcyclohexyl isopropylphosphonofluoridate

Schedule: 1A01

CAS RN: HS code: 2931.39

Key: (5441-52-1)-I1A1

Molecular formula: C<sub>11</sub>H<sub>22</sub>FO<sub>2</sub>P

CAS Index Name: Phosphonofluoridic acid, 1-methylethyl-, 3,5-dimethylcyclohexyl ester

**IUPAC name:** 3,5-Dimethylcyclohexyl isopropylphosphonofluoridoate

Synonyms: O-3,5-Dimethylcyclohexyl isopropylphosphonofluoridate

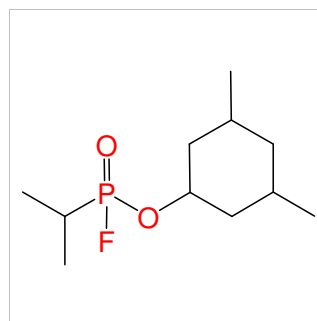

**Chemical name:** 3,5-Dimethylcyclohexyl propylphosphonofluoridate

Schedule: 1A01

CAS RN: HS code: 2931.39

Key: (5441-52-1)-P1A1

Molecular formula: C<sub>11</sub>H<sub>22</sub>FO<sub>2</sub>P

CAS Index Name: Phosphonofluoridic acid, propyl-, 3,5-dimethylcyclohexyl ester

**IUPAC name:** 3,5-Dimethylcyclohexyl propylphosphonofluoridoate

Synonyms: O-3,5-Dimethylcyclohexyl propylphosphonofluoridate

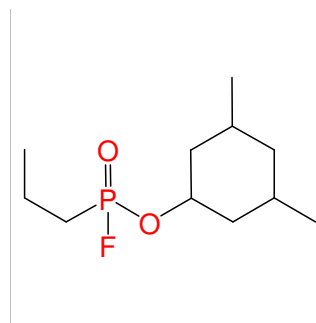

**Chemical name:** 1,2-Dimethylbutyl propylphosphonofluoridate

Schedule: 1A01

CAS RN: HS code: 2931.39

Key: (565-60-6)-P1A1

Molecular formula: C<sub>9</sub>H<sub>20</sub>FO<sub>2</sub>P

CAS Index Name: Phosphonofluoridic acid, propyl-, 1,2-dimethylbutyl ester

**IUPAC name:** 1,2-Dimethylbutyl propylphosphonofluoridoate

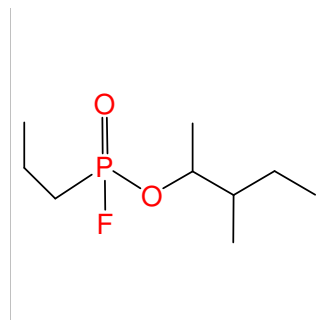

Synonyms: Phosphonofluoridic acid, propyl-, 3-methylpent-2-yl ester

O-1,2-Dimethylbutyl propylphosphonofluoridate

3-Methylpentan-2-yl propylphosphonofluoridate

3-Methylpent-2-yl propylphosphonofluoridate

**Chemical name:** 1,5-Dimethyl-1-ethylhexyl methylphosphonofluoridate

Schedule: 1A01

CAS RN: HS code: 2931.39

Key: (57706-88-4)-M1A1

Molecular formula: C<sub>11</sub>H<sub>24</sub>FO<sub>2</sub>P

CAS Index Name: Phosphonofluoridic acid, methyl-, 1,5-dimethyl-1-ethylhexyl ester

**IUPAC name:** 1,5-Dimethyl-1-ethylhexyl methylphosphonofluoridoate

Synonyms: O-1,5-Dimethyl-1-ethylhexyl methylphosphonofluoridate

3,7-Dimethyloctan-3-yl methylphosphonofluoridate

3,7-Dimethyloct-3-yl methylphosphonofluoridate

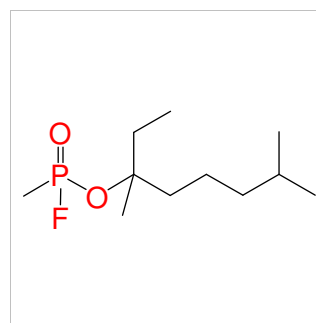

**Chemical name:** 2-Propylpentyl ethylphosphonofluoridate

Schedule: 1A01

CAS RN: HS code: 2931.39

Key: (58175-57-8)-E1A1

Molecular formula: C<sub>10</sub>H<sub>22</sub>FO<sub>2</sub>P

CAS Index Name: Phosphonofluoric acid, ethyl-, 2-propylpentyl ester

**IUPAC name:** 2-Propylpentyl ethylphosphonofluoridoate

Synonyms: O-2-Propylpentyl ethylphosphonofluoridate

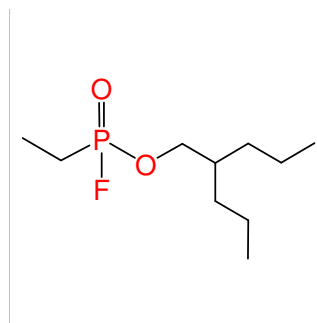

**Chemical name:** 2-Propylpentyl isopropylphosphonofluoridate

Schedule: 1A01

CAS RN: HS code: 2931.39

Key: (58175-57-8)-I1A1

Molecular formula: C<sub>11</sub>H<sub>24</sub>FO<sub>2</sub>P

CAS Index Name: Phosphonofluoric acid, 1-methylethyl-, 2-propylpentyl ester

**IUPAC name:** 2-Propylpentyl isopropylphosphonofluoridoate

Synonyms: O-2-Propylpentyl isopropylphosphonofluoridate

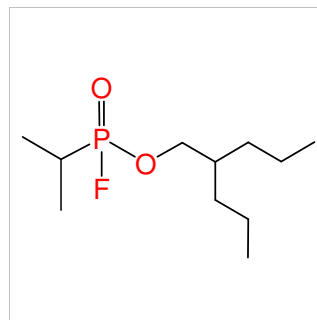

**Chemical name:** 2-Propylpentyl propylphosphonofluoridate

Schedule: 1A01

CAS RN: HS code: 2931.39

Key: (58175-57-8)-P1A1

Molecular formula: C<sub>11</sub>H<sub>24</sub>FO<sub>2</sub>P

CAS Index Name: Phosphonofluoric acid, propyl-, 2-propylpentyl ester

**IUPAC name:** 2-Propylpentyl propylphosphonofluoridoate

Synonyms: O-2-Propylpentyl propylphosphonofluoridate

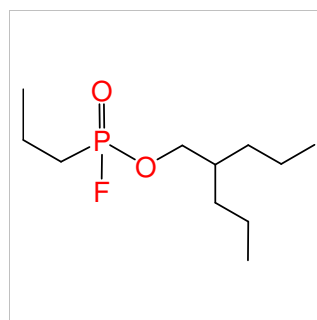

**Chemical name:** 2-Methylcyclohexyl isopropylphosphonofluoridate

Schedule: 1A01

CAS RN: HS code: 2931.39

Key: (583-59-5)-I1A1

Molecular formula: C<sub>10</sub>H<sub>20</sub>FO<sub>2</sub>P

CAS Index Name: Phosphonofluoric acid, 1-methylethyl-, 2-methylcyclohexyl ester

**IUPAC name:** 2-Methylcyclohexyl isopropylphosphonofluoridoate

Synonyms: O-2-Methylcyclohexyl isopropylphosphonofluoridate

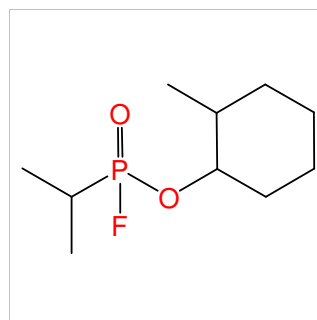



**Chemical name:** 2-Methylcyclohexyl propylphosphonofluoridate

Schedule: 1A01

CAS RN: HS code: 2931.39

Key: (583-59-5)-P1A1

Molecular formula: C<sub>10</sub>H<sub>20</sub>FO<sub>2</sub>P

CAS Index Name: Phosphonofluoridic acid, propyl-, 2-methylcyclohexyl ester

**IUPAC name:** 2-Methylcyclohexyl propylphosphonofluoridoate

Synonyms: O-2-Methylcyclohexyl propylphosphonofluoridate

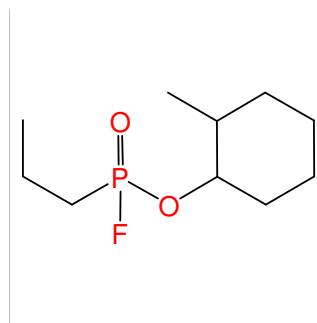

**Chemical name:** 1-Ethylpropyl isopropylphosphonofluoridate

Schedule: 1A01

CAS RN: HS code: 2931.39

Key: (584-02-1)-I1A1

Molecular formula: C<sub>8</sub>H<sub>18</sub>FO<sub>2</sub>P

CAS Index Name: Phosphonofluoridic acid, 1-methylethyl-, 1-ethylpropyl ester

**IUPAC name:** 1-Ethylpropyl isopropylphosphonofluoridoate

Synonyms: Pentan-3-yl isopropylphosphonofluoridate

Pent-3-yl isopropylphosphonofluoridate

O-1-Ethylpropyl isopropylphosphonofluoridate

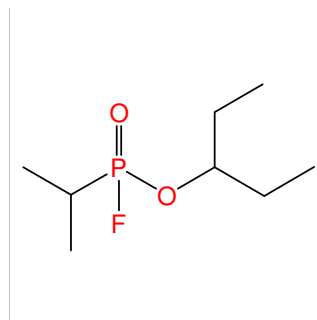

**Chemical name:** 3-Methylpentyl isopropylphosphonofluoridate

Schedule: 1A01

CAS RN: HS code: 2931.39

Key: (589-35-5)-I1A1

Molecular formula: C<sub>9</sub>H<sub>20</sub>FO<sub>2</sub>P

CAS Index Name: Phosphonofluoridic acid, 1-methylethyl-, 3-methylpentyl ester

**IUPAC name:** 3-Methylpentyl isopropylphosphonofluoridoate

Synonyms: O-3-Methylpentyl isopropylphosphonofluoridate

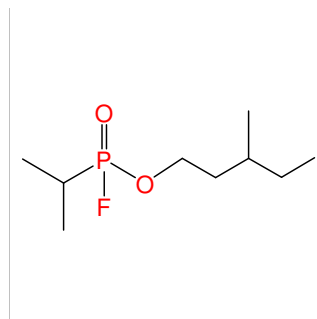

**Chemical name:** 3-Methylpentyl propylphosphonofluoridate

Schedule: 1A01

CAS RN: HS code: 2931.39

Key: (589-35-5)-P1A1

Molecular formula: C<sub>9</sub>H<sub>20</sub>FO<sub>2</sub>P

CAS Index Name: Phosphonofluoridic acid, propyl-, 3-methylpentyl ester

**IUPAC name:** 3-Methylpentyl propylphosphonofluoridoate

Synonyms: O-3-Methylpentyl propylphosphonofluoridate

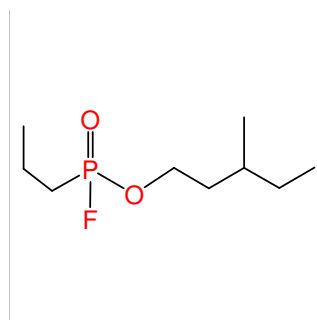

**Chemical name:** 1-Propylpentyl ethylphosphonofluoridate

Schedule: 1A01

CAS RN: HS code: 2931.39

Key: (589-62-8)-E1A1

Molecular formula: C<sub>10</sub>H<sub>22</sub>FO<sub>2</sub>P

CAS Index Name: Phosphonofluoridic acid, ethyl-, 1-propylpentyl ester

**IUPAC name:** 1-Propylpentyl ethylphosphonofluoridoate

Synonyms: Phosphonofluoridic acid, ethyl-, oct-4-yl ester

Octan-4-yl ethylphosphonofluoridate

Oct-4-yl ethylphosphonofluoridate

O-1-Propylpentyl ethylphosphonofluoridate

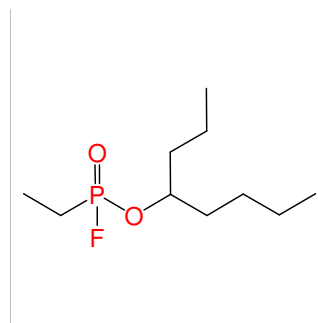

**Chemical name:** 1-Propylpentyl isopropylphosphonofluoridate

Schedule: 1A01

CAS RN: HS code: 2931.39

Key: (589-62-8)-I1A1

Molecular formula: C<sub>11</sub>H<sub>24</sub>FO<sub>2</sub>P

CAS Index Name: Phosphonofluoridic acid, 1-methylethyl-, 1-propylpentyl ester

**IUPAC name:** 1-Propylpentyl isopropylphosphonofluoridoate

Synonyms: Phosphonofluoridic acid, 1-methylethyl-, oct-4-yl ester

Octan-4-yl isopropylphosphonofluoridate

Oct-4-yl isopropylphosphonofluoridate

O-1-Propylpentyl isopropylphosphonofluoridate

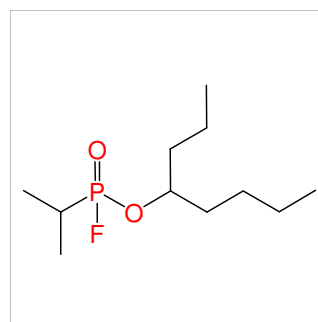

**Chemical name:** 1-Propylpentyl methylphosphonofluoridate

Schedule: 1A01

CAS RN: HS code: 2931.39

Key: (589-62-8)-M1A1

Molecular formula: C<sub>9</sub>H<sub>20</sub>FO<sub>2</sub>P

CAS Index Name: Phosphonofluoridic acid, methyl-, 1-propylpentyl ester

**IUPAC name:** 1-Propylpentyl methylphosphonofluoridoate

Synonyms: Phosphonofluoridic acid, methyl-, oct-4-yl ester

Octan-4-yl methylphosphonofluoridate

Oct-4-yl methylphosphonofluoridate

O-1-Propylpentyl methylphosphonofluoridate

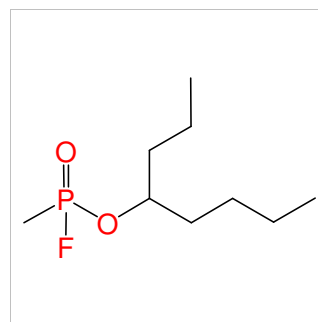

**Chemical name:** 1-Propylpentyl propylphosphonofluoridate

Schedule: 1A01

CAS RN: HS code: 2931.39

Key: (589-62-8)-P1A1

Molecular formula: C<sub>11</sub>H<sub>24</sub>FO<sub>2</sub>P

CAS Index Name: Phosphonofluoridic acid, propyl-, 1-propylpentyl ester

**IUPAC name:** 1-Propylpentyl propylphosphonofluoridoate

Synonyms: Phosphonofluoridic acid, propyl-, oct-4-yl ester

Octan-4-yl propylphosphonofluoridate

Oct-4-yl propylphosphonofluoridate

O-1-Propylpentyl propylphosphonofluoridate

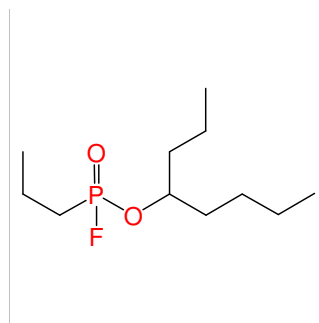

**Chemical name:** 1-Ethylpentyl ethylphosphonofluoridate

Schedule: 1A01

CAS RN: HS code: 2931.39

Key: (589-82-2)-E1A1

Molecular formula: C<sub>9</sub>H<sub>20</sub>FO<sub>2</sub>P

CAS Index Name: Phosphonofluoridic acid, ethyl-, 1-ethylpentyl ester

**IUPAC name:** 1-Ethylpentyl ethylphosphonofluoridoate

Synonyms: Phosphonofluoridic acid, ethyl-, hept-3-yl ester

O-1-Ethylpentyl ethylphosphonofluoridate

Heptan-3-yl ethylphosphonofluoridate

Hept-3-yl ethylphosphonofluoridate

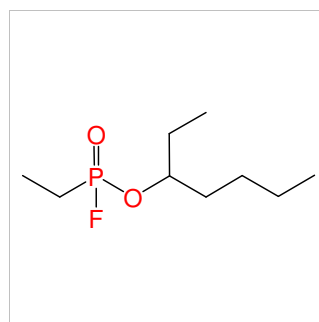

**Chemical name:** 1-Ethylpentyl isopropylphosphonofluoridate

Schedule: 1A01

CAS RN: HS code: 2931.39

Key: (589-82-2)-I1A1

Molecular formula: C<sub>10</sub>H<sub>22</sub>FO<sub>2</sub>P

CAS Index Name: Phosphonofluoridic acid, 1-methylethyl-, 1-ethylpentyl ester

**IUPAC name:** 1-Ethylpentyl isopropylphosphonofluoridoate

Synonyms: Phosphonofluoridic acid, 1-methylethyl-, hept-3-yl ester

O-1-Ethylpentyl isopropylphosphonofluoridate

Heptan-3-yl isopropylphosphonofluoridate

Hept-3-yl isopropylphosphonofluoridate

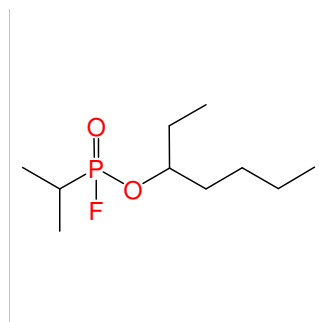

**Chemical name:** 1-Ethylpentyl propylphosphonofluoridate

Schedule: 1A01

CAS RN: HS code: 2931.39

Key: (589-82-2)-P1A1

Molecular formula: C<sub>10</sub>H<sub>22</sub>FO<sub>2</sub>P

CAS Index Name:

**IUPAC name:**

Synonyms:

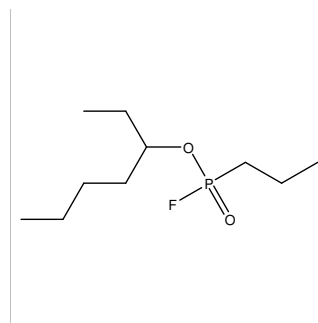

**Chemical name:** 1,2-Dimethylpropyl ethylphosphonofluoridate

Schedule: 1A01

CAS RN: HS code: 2931.39

Key: (598-75-4)-E1A1

Molecular formula: C<sub>7</sub>H<sub>16</sub>FO<sub>2</sub>P

CAS Index Name: Phosphonofluoridic acid, ethyl-, 1,2-dimethylpropyl ester

**IUPAC name:** 1,2-Dimethylpropyl ethylphosphonofluoridoate

Synonyms: O-1,2-Dimethylpropyl ethylphosphonofluoridate

3-Methylbutan-2-yl ethylphosphonofluoridate

3-Methylbut-2-yl ethylphosphonofluoridate

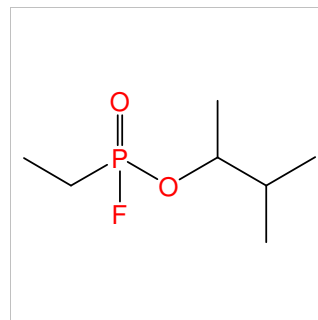

**Chemical name:** 1,2-Dimethylpropyl isopropylphosphonofluoridate

Schedule: 1A01

CAS RN: HS code: 2931.39

Key: (598-75-4)-I1A1

Molecular formula: C<sub>8</sub>H<sub>18</sub>FO<sub>2</sub>P

CAS Index Name: Phosphonofluoridic acid, 1-methylethyl-, 1,2-dimethylpropyl ester

**IUPAC name:** 1,2-Dimethylpropyl isopropylphosphonofluoridoate

Synonyms: O-1,2-Dimethylpropyl isopropylphosphonofluoridate

3-Methylbutan-2-yl isopropylphosphonofluoridate

3-Methylbut-2-yl isopropylphosphonofluoridate

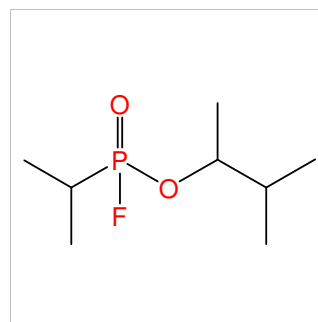

**Chemical name:** 1,2-Dimethylpropyl propylphosphonofluoridate

Schedule: 1A01

CAS RN: HS code: 2931.39

Key: (598-75-4)-P1A1

Molecular formula: C<sub>8</sub>H<sub>18</sub>FO<sub>2</sub>P

CAS Index Name: Phosphonofluoridic acid, propyl-, 1,2-dimethylpropyl ester

**IUPAC name:** 1,2-Dimethylpropyl propylphosphonofluoridoate

Synonyms: O-1,2-Dimethylpropyl propylphosphonofluoridate

3-Methylbutan-2-yl propylphosphonofluoridate

3-Methylbut-2-yl propylphosphonofluoridate

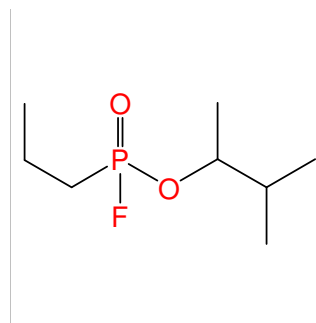

**Chemical name:** 1,3,3-Trimethylbutyl ethylphosphonofluoridate

Schedule: 1A01

CAS RN: HS code: 2931.39

Key: (6144-93-0)-E1A1

Molecular formula: C<sub>9</sub>H<sub>20</sub>FO<sub>2</sub>P

CAS Index Name: Phosphonofluoridic acid, ethyl-, 1,3,3-trimethylbutyl ester

**IUPAC name:** 1,3,3-Trimethylbutyl ethylphosphonofluoridoate

Synonyms: Phosphonofluoridic acid, ethyl-, 4,4-dimethylpent-2-yl ester

O-1,3,3-Trimethylbutyl ethylphosphonofluoridate

4,4-Dimethylpentan-2-yl ethylphosphonofluoridate

4,4-Dimethylpent-2-yl ethylphosphonofluoridate

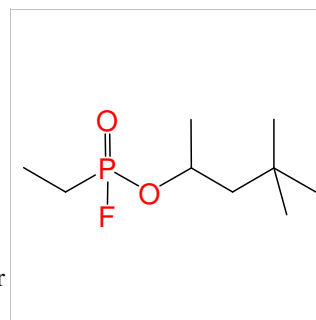

**Chemical name:** 1,3,3-Trimethylbutyl isopropylphosphonofluoridate

Schedule: 1A01

CAS RN: HS code: 2931.39

Key: (6144-93-0)-I1A1

Molecular formula: C<sub>10</sub>H<sub>22</sub>FO<sub>2</sub>P

CAS Index Name: Phosphonofluoridic acid, 1-methylethyl-, 1,3,3-trimethylbutyl ester

**IUPAC name:** 1,3,3-Trimethylbutyl isopropylphosphonofluoridoate

Synonyms: Phosphonofluoridic acid, 1-methylethyl-, 4,4-dimethylpent-2-yl ester

O-1,3,3-Trimethylbutyl isopropylphosphonofluoridate

4,4-Dimethylpentan-2-yl isopropylphosphonofluoridate

4,4-Dimethylpent-2-yl isopropylphosphonofluoridate

4,4-Dimethylpent-2-yl 1-methylethylphosphonofluoridate

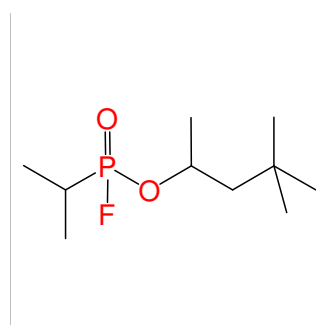

**Chemical name:** 1,3,3-Trimethylbutyl propylphosphonofluoridate

Schedule: 1A01

CAS RN: HS code: 2931.39

Key: (6144-93-0)-P1A1

Molecular formula: C<sub>10</sub>H<sub>22</sub>FO<sub>2</sub>P

CAS Index Name: Phosphonofluoridic acid, propyl-, 1,3,3-trimethylbutyl ester

**IUPAC name:** 1,3,3-Trimethylbutyl propylphosphonofluoridoate

Synonyms: Phosphonofluoridic acid, propyl-, 4,4-dimethylpent-2-yl ester

O-1,3,3-Trimethylbutyl propylphosphonofluoridate

4,4-Dimethylpentan-2-yl propylphosphonofluoridate

4,4-Dimethylpent-2-yl propylphosphonofluoridate

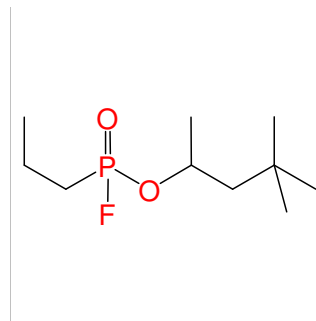

**Chemical name:** 1-Ethylbutyl ethylphosphonofluoridate

Schedule: 1A01

CAS RN: HS code: 2931.39

Key: (623-37-0)-E1A1

Molecular formula: C<sub>8</sub>H<sub>18</sub>FO<sub>2</sub>P

CAS Index Name: Phosphonofluoridic acid, ethyl-, 1-ethylbutyl ester

**IUPAC name:** 1-Ethylbutyl ethylphosphonofluoridoate

Synonyms: O-1-Ethylbutyl ethylphosphonofluoridate

Hexan-3-yl ethylphosphonofluoridate

Hex-3-yl ethylphosphonofluoridate

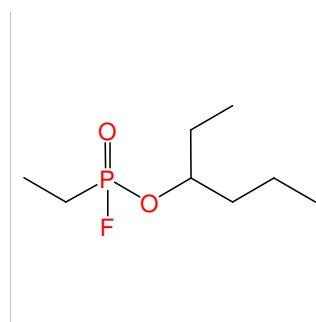

**Chemical name:** 1-Ethylbutyl isopropylphosphonofluoridate

Schedule: 1A01

CAS RN: HS code: 2931.39

Key: (623-37-0)-I1A1

Molecular formula: C<sub>9</sub>H<sub>20</sub>FO<sub>2</sub>P

CAS Index Name:

**IUPAC name:**

Synonyms:

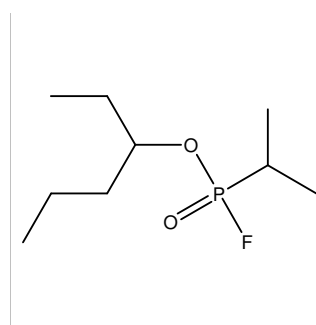

**Chemical name:** 1-Ethylbutyl propylphosphonofluoridate

Schedule: 1A01

CAS RN: HS code: 2931.39

Key: (623-37-0)-P1A1

Molecular formula: C<sub>9</sub>H<sub>20</sub>FO<sub>2</sub>P

CAS Index Name: Phosphonofluoridic acid, propyl-, 1-ethylbutyl ester

**IUPAC name:** 1-Ethylbutyl propylphosphonofluoridoate

Synonyms: O-1-Ethylbutyl propylphosphonofluoridate

Hexan-3-yl propylphosphonofluoridate

Hex-3-yl propylphosphonofluoridate

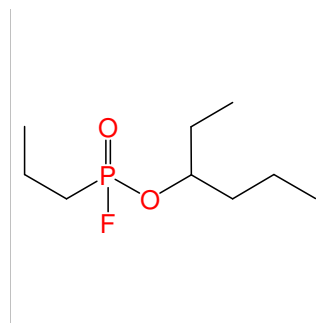

**Chemical name:** 1-Butylpentyl ethylphosphonofluoridate

Schedule: 1A01

CAS RN: HS code: 2931.39

Key: (623-93-8)-E1A1

Molecular formula: C<sub>11</sub>H<sub>24</sub>FO<sub>2</sub>P

CAS Index Name: Phosphonofluoridic acid, ethyl-, 1-butylpentyl ester

**IUPAC name:** 1-Butylpentyl ethylphosphonofluoridoate

Synonyms: Phosphonofluoridic acid, ethyl-, non-5-yl ester

O-1-Butylpentyl ethylphosphonofluoridate

Nonan-5-yl ethylphosphonofluoridate

Non-5-yl ethylphosphonofluoridate

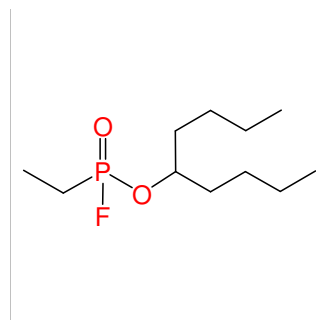

**Chemical name:** 1-Butylpentyl isopropylphosphonofluoridate

Schedule: 1A01

CAS RN: HS code: 2931.39

Key: (623-93-8)-I1A1

Molecular formula: C<sub>12</sub>H<sub>26</sub>FO<sub>2</sub>P

CAS Index Name: Phosphonofluoridic acid, 1-methylethyl-, 1-butylpentyl ester

**IUPAC name:** 1-Butylpentyl isopropylphosphonofluoridoate

Synonyms: Phosphonofluoridic acid, 1-methylethyl-, non-5-yl ester

O-1-Butylpentyl isopropylphosphonofluoridate

Nonan-5-yl isopropylphosphonofluoridate

Non-5-yl isopropylphosphonofluoridate

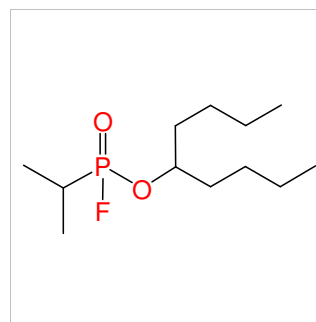

**Chemical name:** 1-Butylpentyl methylphosphonofluoridate

Schedule: 1A01

CAS RN: HS code: 2931.39

Key: (623-93-8)-M1A1

Molecular formula: C<sub>10</sub>H<sub>22</sub>FO<sub>2</sub>P

CAS Index Name: Phosphonofluoridic acid, methyl-, 1-butylpentyl ester

**IUPAC name:** 1-Butylpentyl methylphosphonofluoridoate

Synonyms: Phosphonofluoridic acid, methyl-, non-5-yl ester

O-1-Butylpentyl methylphosphonofluoridate

Nonan-5-yl methylphosphonofluoridate

Non-5-yl methylphosphonofluoridate

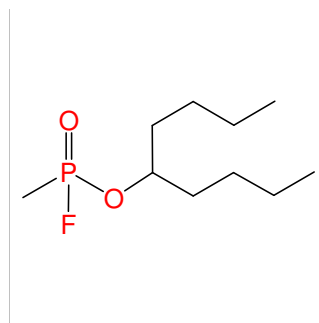

**Chemical name:** 1-Butylpentyl propylphosphonofluoridate

Schedule: 1A01

CAS RN: HS code: 2931.39

Key: (623-93-8)-P1A1

Molecular formula: C<sub>12</sub>H<sub>26</sub>FO<sub>2</sub>P

CAS Index Name: Phosphonofluoridic acid, propyl-, 1-butylpentyl ester

**IUPAC name:** 1-Butylpentyl propylphosphonofluoridoate

Synonyms: Phosphonofluoridic acid, propyl-, non-5-yl ester

O-1-Butylpentyl propylphosphonofluoridate

Nonan-5-yl propylphosphonofluoridate

Non-5-yl propylphosphonofluoridate

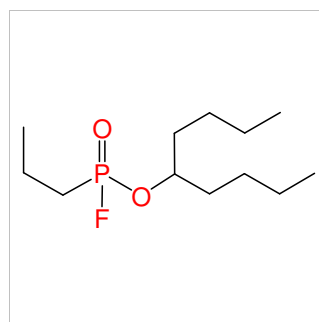

**Chemical name:** 1-Ethylheptyl ethylphosphonofluoridate

Schedule: 1A01

CAS RN: HS code: 2931.39

Key: (624-51-1)-E1A1

Molecular formula: C<sub>11</sub>H<sub>24</sub>FO<sub>2</sub>P

CAS Index Name: Phosphonofluoridic acid, ethyl-, 1-ethylheptyl ester

**IUPAC name:** 1-Ethylheptyl ethylphosphonofluoridoate

Synonyms: Phosphonofluoridic acid, ethyl-, non-3-yl ester

O-1-Ethylheptyl ethylphosphonofluoridate

Nonan-3-yl ethylphosphonofluoridate

Non-3-yl ethylphosphonofluoridate

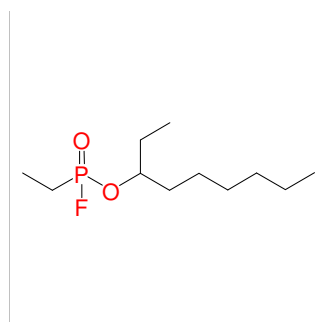



**Chemical name:** 1-Ethylheptyl isopropylphosphonofluoridate

Schedule: 1A01

CAS RN: HS code: 2931.39

Key: (624-51-1)-I1A1

Molecular formula: C<sub>12</sub>H<sub>26</sub>FO<sub>2</sub>P

CAS Index Name: Phosphonofluoridic acid, 1-methylethyl-, 1-ethylheptyl ester

**IUPAC name:** 1-Ethylheptyl isopropylphosphonofluoridoate

Synonyms: Phosphonofluoridic acid, 1-methylethyl-, non-3-yl ester

O-1-Ethylheptyl isopropylphosphonofluoridate

Nonan-3-yl isopropylphosphonofluoridate

Non-3-yl isopropylphosphonofluoridate

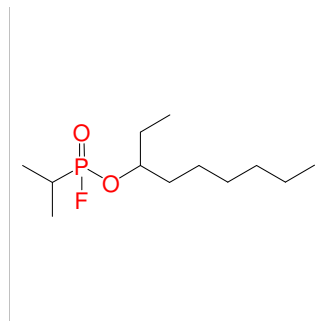

**Chemical name:** 1-Ethylheptyl methylphosphonofluoridate

Schedule: 1A01

CAS RN: HS code: 2931.39

Key: (624-51-1)-M1A1

Molecular formula: C<sub>10</sub>H<sub>22</sub>FO<sub>2</sub>P

CAS Index Name: Phosphonofluoridic acid, methyl-, 1-ethylheptyl ester

**IUPAC name:** 1-Ethylheptyl methylphosphonofluoridoate

Synonyms: Phosphonofluoridic acid, methyl-, non-3-yl ester

O-1-Ethylheptyl methylphosphonofluoridate

Nonan-3-yl methylphosphonofluoridate

Non-3-yl methylphosphonofluoridate

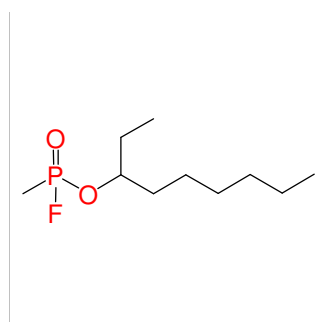

**Chemical name:** 1-Ethylheptyl propylphosphonofluoridate

Schedule: 1A01

CAS RN: HS code: 2931.39

Key: (624-51-1)-P1A1

Molecular formula: C<sub>12</sub>H<sub>26</sub>FO<sub>2</sub>P

CAS Index Name: Phosphonofluoridic acid, propyl-, 1-ethylheptyl ester

**IUPAC name:** 1-Ethylheptyl propylphosphonofluoridoate

Synonyms: Phosphonofluoridic acid, propyl-, non-3-yl ester

O-1-Ethylheptyl propylphosphonofluoridate

Nonan-3-yl propylphosphonofluoridate

Non-3-yl propylphosphonofluoridate

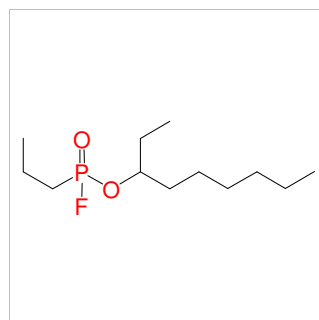

**Chemical name:** 3,3-Dimethylbutyl ethylphosphonofluoridate

Schedule: 1A01

CAS RN: HS code: 2931.39

Key: (624-95-3)-E1A1

Molecular formula: C<sub>8</sub>H<sub>18</sub>FO<sub>2</sub>P

CAS Index Name: Phosphonofluoridic acid, ethyl-, 3,3-dimethylbutyl ester

**IUPAC name:** 3,3-Dimethylbutyl ethylphosphonofluoridoate

Synonyms: O-3,3-Dimethylbutyl ethylphosphonofluoridate

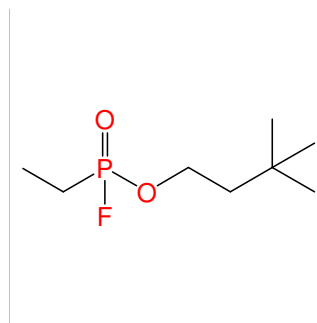

**Chemical name:** 3,3-Dimethylbutyl isopropylphosphonofluoridate

Schedule: 1A01

CAS RN: HS code: 2931.39

Key: (624-95-3)-I1A1

Molecular formula: C<sub>9</sub>H<sub>20</sub>FO<sub>2</sub>P

CAS Index Name: Phosphonofluoridic acid, 1-methylethyl-, 3,3-dimethylbutyl ester

**IUPAC name:** 3,3-Dimethylbutyl isopropylphosphonofluoridoate

Synonyms: O-3,3-Dimethylbutyl isopropylphosphonofluoridate

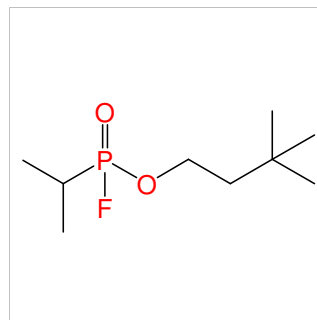

**Chemical name:** 4-Methylpentyl isopropylphosphonofluoridate

Schedule: 1A01

CAS RN: HS code: 2931.39

Key: (626-89-1)-I1A1

Molecular formula: C<sub>9</sub>H<sub>20</sub>FO<sub>2</sub>P

CAS Index Name: Phosphonofluoridic acid, 1-methylethyl-, 4-methylpentyl ester

**IUPAC name:** 4-Methylpentyl isopropylphosphonofluoridoate

Synonyms: O-4-Methylpentyl isopropylphosphonofluoridate

Isohexyl isopropylphosphonofluoridate

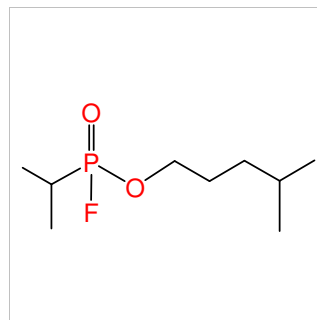

**Chemical name:** 4-Methylpentyl propylphosphonofluoridate

Schedule: 1A01

CAS RN: HS code: 2931.39

Key: (626-89-1)-P1A1

Molecular formula: C<sub>9</sub>H<sub>20</sub>FO<sub>2</sub>P

CAS Index Name: Phosphonofluoridic acid, propyl-, 4-methylpentyl ester

**IUPAC name:** 4-Methylpentyl propylphosphonofluoridoate

Synonyms: O-4-Methylpentyl propylphosphonofluoridate

Isohexyl propylphosphonofluoridate

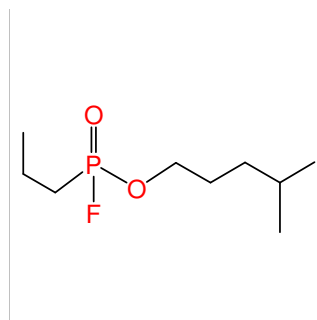

**Chemical name:** 1-Methylpentyl ethylphosphonofluoridate

Schedule: 1A01

CAS RN: HS code: 2931.39

Key: (626-93-7)-E1A1

Molecular formula: C<sub>8</sub>H<sub>18</sub>FO<sub>2</sub>P

CAS Index Name: Phosphonofluoridic acid, ethyl-, 1-methylpentyl ester

**IUPAC name:** 1-Methylpentyl ethylphosphonofluoridoate

Synonyms: O-1-Methylpentyl ethylphosphonofluoridate

Hexan-2-yl ethylphosphonofluoridate

Hex-2-yl ethylphosphonofluoridate

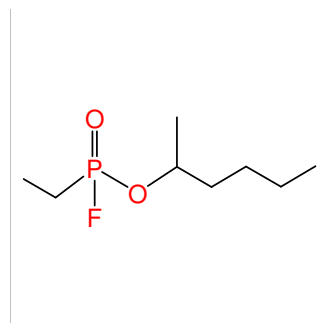

**Chemical name:** 1-Methylpentyl isopropylphosphonofluoridate

Schedule: 1A01

CAS RN: HS code: 2931.39

Key: (626-93-7)-I1A1

Molecular formula: C<sub>9</sub>H<sub>20</sub>FO<sub>2</sub>P

CAS Index Name: Phosphonofluoridic acid, 1-methylethyl-, 1-methylpentyl ester

**IUPAC name:** 1-Methylpentyl isopropylphosphonofluoridoate

Synonyms: O-1-Methylpentyl isopropylphosphonofluoridate

Hexan-2-yl isopropylphosphonofluoridate

Hex-2-yl isopropylphosphonofluoridate

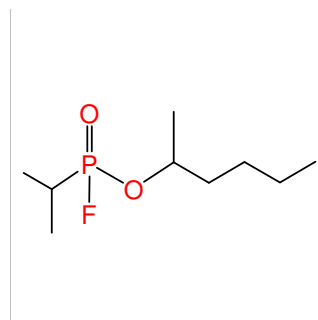

**Chemical name:** 1-Methylpentyl propylphosphonofluoridate

Schedule: 1A01

CAS RN: HS code: 2931.39

Key: (626-93-7)-P1A1

Molecular formula: C<sub>9</sub>H<sub>20</sub>FO<sub>2</sub>P

CAS Index Name: Phosphonofluoridic acid, propyl-, 1-methylpentyl ester

**IUPAC name:** 1-Methylpentyl propylphosphonofluoridoate

Synonyms: O-1-Methylpentyl propylphosphonofluoridate

Hexan-2-yl propylphosphonofluoridate

Hex-2-yl propylphosphonofluoridate

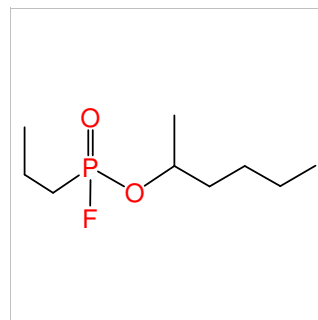

**Chemical name:** 1,4-Dimethylpentyl ethylphosphonofluoridate

Schedule: 1A01

CAS RN: HS code: 2931.39

Key: (627-59-8)-E1A1

Molecular formula: C<sub>9</sub>H<sub>20</sub>FO<sub>2</sub>P

CAS Index Name: Phosphonofluoric acid, ethyl-, 1,4-dimethylpentyl ester

**IUPAC name:** 1,4-Dimethylpentyl ethylphosphonofluoridoate

Synonyms: Phosphonofluoric acid, ethyl-, 5-methylhex-2-yl ester

O-1,4-Dimethylpentyl ethylphosphonofluoridate

5-Methylhexan-2-yl ethylphosphonofluoridate

5-Methylhex-2-yl ethylphosphonofluoridate

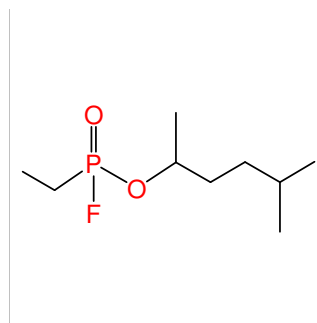

**Chemical name:** 1,4-Dimethylpentyl isopropylphosphonofluoridate

Schedule: 1A01

CAS RN: HS code: 2931.39

Key: (627-59-8)-I1A1

Molecular formula: C<sub>10</sub>H<sub>22</sub>FO<sub>2</sub>P

CAS Index Name: Phosphonofluoric acid, 1-methylethyl-, 1,4-dimethylpentyl ester

**IUPAC name:** 1,4-Dimethylpentyl isopropylphosphonofluoridoate

Synonyms: Phosphonofluoric acid, 1-methylethyl-, 5-methylhex-2-yl ester

O-1,4-Dimethylpentyl isopropylphosphonofluoridate

5-Methylhexan-2-yl isopropylphosphonofluoridate

5-Methylhex-2-yl isopropylphosphonofluoridate

5-Methylhex-2-yl 1-methylethylphosphonofluoridate

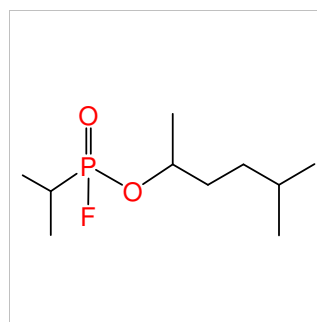

**Chemical name:** 1,4-Dimethylpentyl propylphosphonofluoridate

Schedule: 1A01

CAS RN: HS code: 2931.39

Key: (627-59-8)-P1A1

Molecular formula: C<sub>10</sub>H<sub>22</sub>FO<sub>2</sub>P

CAS Index Name: Phosphonofluoric acid, propyl-, 1,4-dimethylpentyl ester

**IUPAC name:** 1,4-Dimethylpentyl propylphosphonofluoridoate

Synonyms: Phosphonofluoric acid, propyl-, 5-methylhex-2-yl ester

O-5-Methylhex-2-yl propylphosphonofluoridate

O-1,4-Dimethylpentyl propylphosphonofluoridate

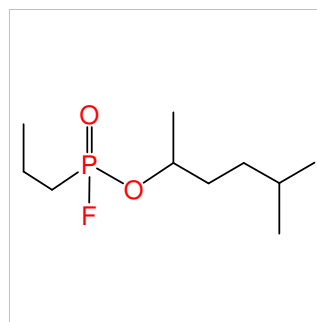

**Chemical name:** 5-Methylhexyl ethylphosphonofluoridate

Schedule: 1A01

CAS RN:

HS code: 2931.39

Key: (627-98-5)-E1A1

Molecular formula: C<sub>9</sub>H<sub>20</sub>FO<sub>2</sub>P

CAS Index Name:

**IUPAC name:**

Synonyms:

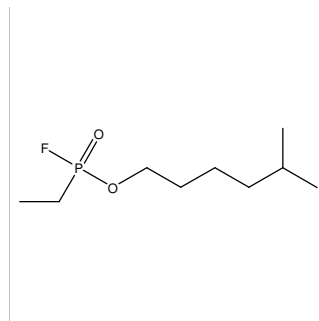

**Chemical name:** 5-Methylhexyl isopropylphosphonofluoridate

Schedule: 1A01

CAS RN:

HS code: 2931.39

Key: (627-98-5)-I1A1

Molecular formula: C<sub>10</sub>H<sub>22</sub>FO<sub>2</sub>P

CAS Index Name:

**IUPAC name:**

Synonyms:

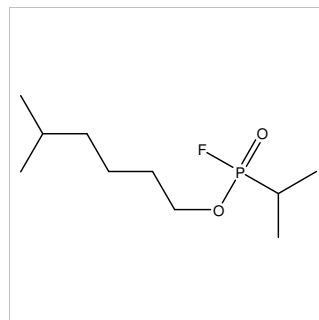

**Chemical name:** 5-Methylhexyl methylphosphonofluoridate

Schedule: 1A01

CAS RN:

HS code: 2931.39

Key: (627-98-5)-M1A1

Molecular formula: C<sub>8</sub>H<sub>18</sub>FO<sub>2</sub>P

CAS Index Name:

**IUPAC name:**

Synonyms:

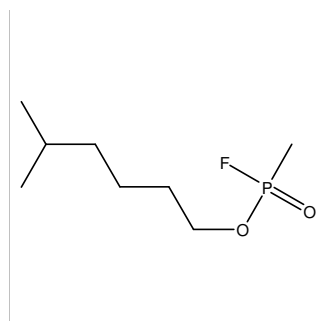

**Chemical name:** 5-Methylhexyl propylphosphonofluoridate

Schedule: 1A01

CAS RN:

HS code: 2931.39

Key: (627-98-5)-P1A1

Molecular formula: C<sub>10</sub>H<sub>22</sub>FO<sub>2</sub>P

CAS Index Name:

**IUPAC name:**

Synonyms:

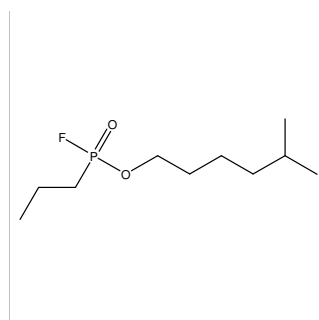

**Chemical name:** Ethyl methyl-d<sub>3</sub>-phosphonofluoridate

Schedule: 1A01

CAS RN: HS code: 2845.90

Key: (64-17-5)-M1A1(D3)

Molecular formula: C<sub>3</sub>H<sub>5</sub>D<sub>3</sub>FO<sub>2</sub>P

CAS Index Name: Phosphonofluoridic acid, methyl-d<sub>3</sub>-, ethyl ester

**IUPAC name:** Ethyl methyl-d<sub>3</sub>-phosphonofluoridoate

Synonyms: O-Ethyl trideuteriomethylphosphonofluoridate

O-Ethyl methyl-d<sub>3</sub>-phosphonofluoridate

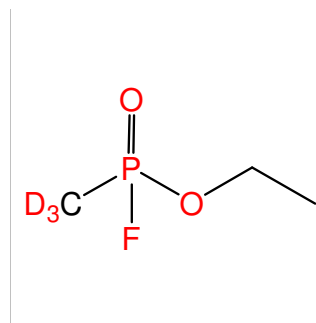

**Chemical name:** 2,2-Dimethylcyclohexyl methylphosphonofluoridate

Schedule: 1A01

CAS RN: HS code: 2931.39

Key: (69542-91-2)-M1A1

Molecular formula: C<sub>9</sub>H<sub>18</sub>FO<sub>2</sub>P

CAS Index Name: Phosphonofluoridic acid, methyl-, 2,2-dimethylcyclohexyl ester

**IUPAC name:** 2,2-Dimethylcyclohexyl methylphosphonofluoridoate

Synonyms: O-2,2-Dimethylcyclohexyl methylphosphonofluoridate

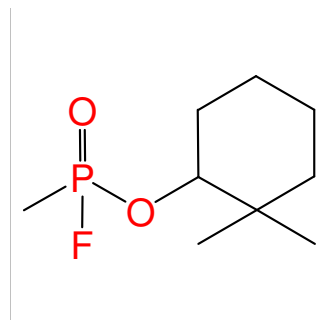

**Chemical name:** tert-Butyl ethylphosphonofluoridate

Schedule: 1A01

CAS RN: HS code: 2931.39

Key: (75-65-0)-E1A1

Molecular formula: C<sub>6</sub>H<sub>14</sub>FO<sub>2</sub>P

CAS Index Name: Phosphonofluoridic acid, ethyl-, 1,1-dimethylethyl ester

**IUPAC name:** tert-Butyl ethylphosphonofluoridoate

Synonyms: O-tert-Butyl ethylphosphonofluoridate

2-Methylpropan-2-yl ethylphosphonofluoridate

2-Methylprop-2-yl ethylphosphonofluoridate

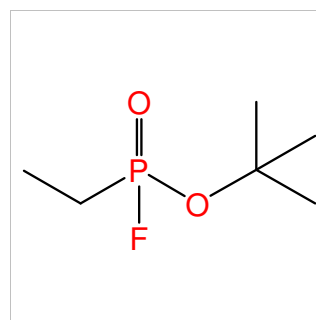

**Chemical name:** tert-Butyl isopropylphosphonofluoridate

Schedule: 1A01

CAS RN: HS code: 2931.39

Key: (75-65-0)-I1A1

Molecular formula: C<sub>7</sub>H<sub>16</sub>FO<sub>2</sub>P

CAS Index Name: Phosphonofluoridic acid, 1-methylethyl-, 1,1-dimethylethyl ester

**IUPAC name:** tert-Butyl isopropylphosphonofluoridoate

Synonyms: t-Butyl isopropylphosphonofluoridate

O-tert-Butyl isopropylphosphonofluoridate

2-Methylpropan-2-yl isopropylphosphonofluoridate

2-Methylprop-2-yl isopropylphosphonofluoridate

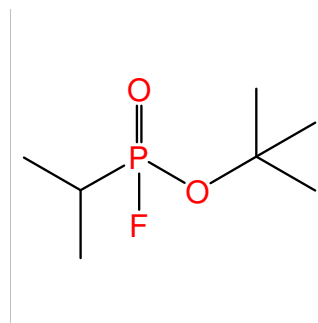

**Chemical name:** 1-Cyclopropylethyl methylphosphonofluoridate

Schedule: 1A01

CAS RN: HS code: 2931.39

Key: (765-42-4)-M1A1

Molecular formula: C<sub>6</sub>H<sub>12</sub>FO<sub>2</sub>P

CAS Index Name:

**IUPAC name:**

Synonyms:

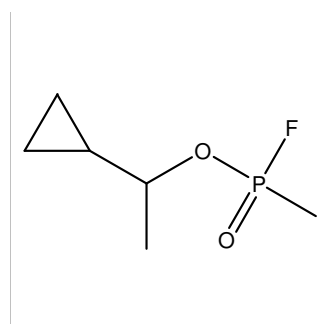

**Chemical name:** 1-Cyclopropylethyl propylphosphonofluoridate

Schedule: 1A01

CAS RN: HS code: 2931.39

Key: (765-42-4)-P1A1

Molecular formula: C<sub>8</sub>H<sub>16</sub>FO<sub>2</sub>P

CAS Index Name:

**IUPAC name:**

Synonyms:

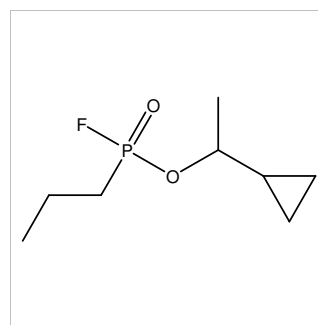

**Chemical name:** 2-Cyclopentylethyl methylphosphonofluoridate

Schedule: 1A01

CAS RN: HS code: 2931.39

Key: (766-00-7)-M1A1

Molecular formula: C<sub>8</sub>H<sub>16</sub>FO<sub>2</sub>P

CAS Index Name: Phosphonofluoridic acid, methyl-, 2-cyclopentylethyl ester

**IUPAC name:** 2-Cyclopentylethyl methylphosphonofluoridoate

Synonyms: O-2-Cyclopentylethyl methylphosphonofluoridate

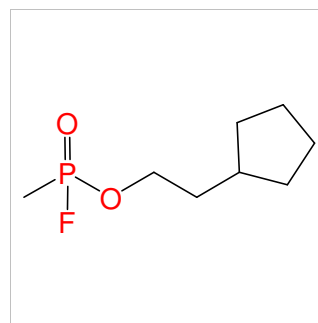

**Chemical name:** 3-Cyclopentylpropyl isopropylphosphonofluoridate

Schedule: 1A01

CAS RN: HS code: 2931.39

Key: (767-05-5)-I1A1

Molecular formula: C<sub>11</sub>H<sub>22</sub>FO<sub>2</sub>P

CAS Index Name: Phosphonofluoridic acid, 1-methylethyl-, 3-cyclopentylpropyl ester

**IUPAC name:** 3-Cyclopentylpropyl isopropylphosphonofluoridoate

Synonyms: O-3-Cyclopentylpropyl isopropylphosphonofluoridate  
3-Cyclopentylpropyl 1-methylethylphosphonofluoridate

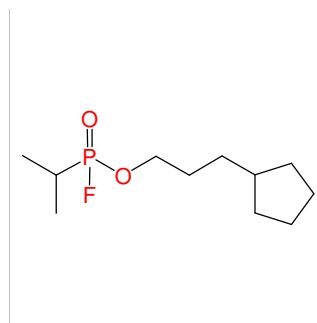

**Chemical name:** 3-Cyclopentylpropyl methylphosphonofluoridate

Schedule: 1A01

CAS RN: HS code: 2931.39

Key: (767-05-5)-M1A1

Molecular formula: C<sub>9</sub>H<sub>18</sub>FO<sub>2</sub>P

CAS Index Name: Phosphonofluoridic acid, methyl-, 3-cyclopentylpropyl ester

**IUPAC name:** 3-Cyclopentylpropyl methylphosphonofluoridoate

Synonyms: O-3-Cyclopentylpropyl methylphosphonofluoridate

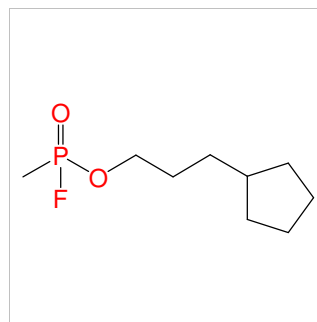

**Chemical name:** 3-Cyclopentylpropyl propylphosphonofluoridate

Schedule: 1A01

CAS RN: HS code: 2931.39

Key: (767-05-5)-P1A1

Molecular formula: C<sub>11</sub>H<sub>22</sub>FO<sub>2</sub>P

CAS Index Name: Phosphonofluoridic acid, propyl-, 3-cyclopentylpropyl ester

**IUPAC name:** 3-Cyclopentylpropyl propylphosphonofluoridoate

Synonyms: O-3-Cyclopentylpropyl propylphosphonofluoridate

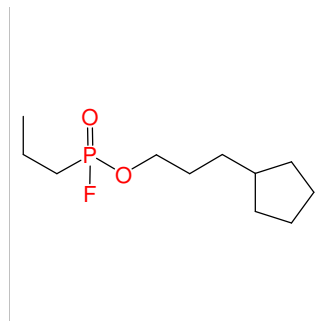

**Chemical name:** 2-Isopropyl-5-methylcyclohexyl propylphosphonofluoridate

Schedule: 1A01

CAS RN: HS code: 2931.39

Key: (89-78-1)-P1A1

Molecular formula: C<sub>13</sub>H<sub>26</sub>FO<sub>2</sub>P

CAS Index Name:

**IUPAC name:**

Synonyms:

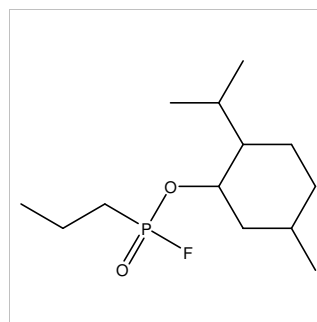



**Chemical name:** 4,4-Dimethylcyclohexyl methylphosphonofluoridate

Schedule: 1A01

CAS RN: HS code: 2931.39

Key: (932-01-4)-M1A1

Molecular formula: C<sub>9</sub>H<sub>18</sub>FO<sub>2</sub>P

CAS Index Name: Phosphonofluoridic acid, methyl-, 4,4-dimethylcyclohexyl ester

**IUPAC name:** 4,4-Dimethylcyclohexyl methylphosphonofluoridoate

Synonyms: O-4,4-Dimethylcyclohexyl methylphosphonofluoridate

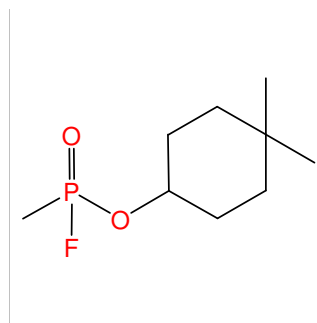

**Chemical name:** 2-Ethylbutyl ethylphosphonofluoridate

Schedule: 1A01

CAS RN: HS code: 2931.39

Key: (97-95-0)-E1A1

Molecular formula: C<sub>8</sub>H<sub>18</sub>FO<sub>2</sub>P

CAS Index Name: Phosphonofluoridic acid, ethyl-, 2-ethylbutyl ester

**IUPAC name:** 2-Ethylbutyl ethylphosphonofluoridoate

Synonyms: O-2-Ethylbutyl ethylphosphonofluoridate

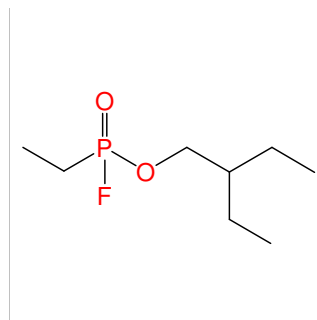

**Chemical name:** 2-Ethylbutyl isopropylphosphonofluoridate

Schedule: 1A01

CAS RN: HS code: 2931.39

Key: (97-95-0)-I1A1

Molecular formula: C<sub>9</sub>H<sub>20</sub>FO<sub>2</sub>P

CAS Index Name: Phosphonofluoridic acid, 1-methylethyl-, 2-ethylbutyl ester

**IUPAC name:** 2-Ethylbutyl isopropylphosphonofluoridoate

Synonyms: O-2-Ethylbutyl isopropylphosphonofluoridate

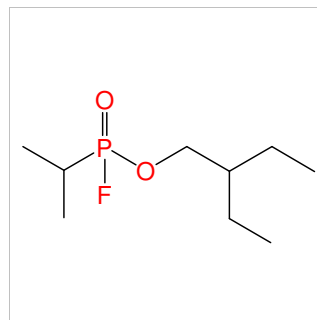

**Chemical name:** 2-Ethylbutyl propylphosphonofluoridate

Schedule: 1A01

CAS RN: HS code: 2931.39

Key: (97-95-0)-P1A1

Molecular formula: C<sub>9</sub>H<sub>20</sub>FO<sub>2</sub>P

CAS Index Name: Phosphonofluoridic acid, propyl-, 2-ethylbutyl ester

**IUPAC name:** 2-Ethylbutyl propylphosphonofluoridoate

Synonyms: O-2-Ethylbutyl propylphosphonofluoridate

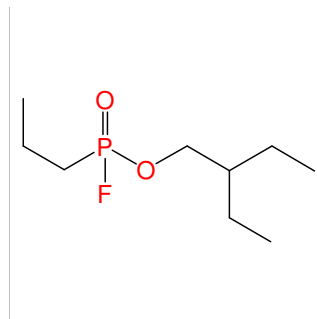

**Chemical name:** 4-tert-Butylcyclohexyl isopropylphosphonofluoridate

Schedule: 1A01

CAS RN: HS code: 2931.39

Key: (98-52-2)-I1A1

Molecular formula: C<sub>13</sub>H<sub>26</sub>FO<sub>2</sub>P

CAS Index Name: Phosphonofluoridic acid, (1-methylethyl)-, 4-(1,1-dimethylethyl)cyclohexyl ester

**IUPAC name:** 4-tert-Butylcyclohexyl isopropylphosphonofluoridoate

Synonyms: O-4-tert-Butylcyclohexyl isopropylphosphonofluoridate

4-(1,1-dimethylethyl)cyclohexyl isopropylphosphonofluoridate

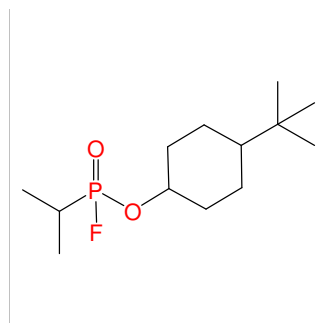

**Chemical name:** 2-tert-Butylcyclohexyl isopropylphosphonofluoridate

Schedule: 1A01

CAS RN: 1005145-75-4 HS code: 2931.39

Key: 1005145-75-4

Molecular formula: C<sub>13</sub>H<sub>26</sub>FO<sub>2</sub>P

CAS Index Name: Phosphonofluoridic acid, 1-methylethyl-, 2-(1,1-dimethylethyl)cyclohexyl ester

**IUPAC name:** 2-tert-Butylcyclohexyl isopropylphosphonofluoridoate

Synonyms: O-2-tert-Butylcyclohexyl isopropylphosphonofluoridate

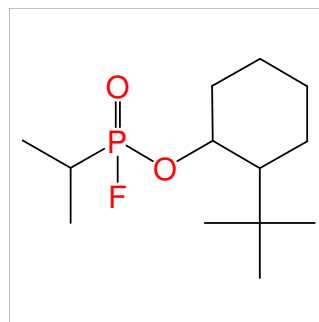

**Chemical name:** 2-Methylcyclopentyl ethylphosphonofluoridate

Schedule: 1A01

CAS RN: 1005164-70-4 HS code: 2931.39

Key: 1005164-70-4

Molecular formula: C<sub>8</sub>H<sub>16</sub>FO<sub>2</sub>P

CAS Index Name: Phosphonofluoridic acid, P-ethyl-, 2-methylcyclopentyl ester

**IUPAC name:** 2-Methylcyclopentyl ethylphosphonofluoridoate

Synonyms: O-2-Methylcyclopentyl ethylphosphonofluoridate

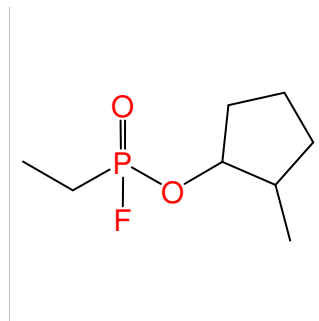

**Chemical name:** 2-Methylcyclopentyl isopropylphosphonofluoridate

Schedule: 1A01

CAS RN: 1005176-59-9 HS code: 2931.39

Key: 1005176-59-9

Molecular formula: C<sub>9</sub>H<sub>18</sub>FO<sub>2</sub>P

CAS Index Name: Phosphonofluoridic acid, 1-methylethyl-, 2-methylcyclopentyl ester

**IUPAC name:** 2-Methylcyclopentyl isopropylphosphonofluoridoate

Synonyms: O-2-Methylcyclopentyl isopropylphosphonofluoridate

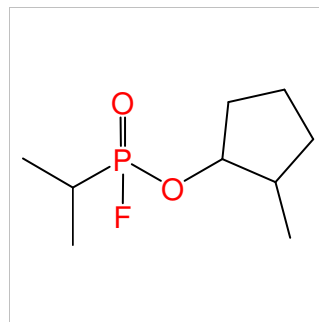

**Chemical name:** 2-Methylcyclopentyl propylphosphonofluoridate

Schedule: 1A01

CAS RN: 1005176-60-2

HS code: 2931.39

Key: 1005176-60-2

Molecular formula: C<sub>9</sub>H<sub>18</sub>FO<sub>2</sub>P

CAS Index Name: Phosphonofluoridic acid, propyl-, 2-methylcyclopentyl ester

**IUPAC name:** 2-Methylcyclopentyl propylphosphonofluoridoate

Synonyms: O-2-Methylcyclopentyl propylphosphonofluoridate

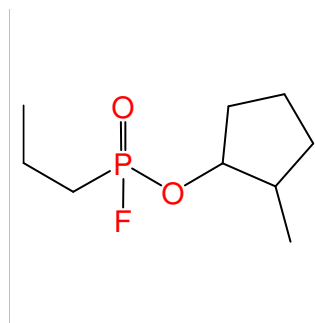

**Chemical name:** 2-tert-Butylcyclohexyl propylphosphonofluoridate

Schedule: 1A01

CAS RN: 1005176-90-8

HS code: 2931.39

Key: 1005176-90-8

Molecular formula: C<sub>13</sub>H<sub>26</sub>FO<sub>2</sub>P

CAS Index Name: Phosphonofluoridic acid, propyl-, 2-(1,1-dimethylethyl)cyclohexyl ester

**IUPAC name:** 2-tert-Butylcyclohexyl propylphosphonofluoridoate

Synonyms: O-2-tert-Butylcyclohexyl propylphosphonofluoridate

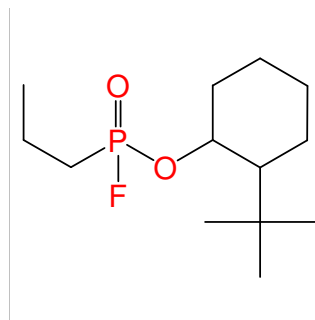

**Chemical name:** 1,2-Dimethylbutyl methylphosphonofluoridate

Schedule: 1A01

CAS RN: 1005239-89-3

HS code: 2931.39

Key: 1005239-89-3

Molecular formula: C<sub>7</sub>H<sub>16</sub>FO<sub>2</sub>P

CAS Index Name: Phosphonofluoridic acid, methyl-, 1,2-dimethylbutyl ester

**IUPAC name:** 1,2-Dimethylbutyl methylphosphonofluoridoate

Synonyms: Phosphonofluoridic acid, methyl-, 3-methylpent-2-yl ester

O-1,2-Dimethylbutyl methylphosphonofluoridate

3-Methylpentan-2-yl methylphosphonofluoridate

3-Methylpent-2-yl methylphosphonofluoridate

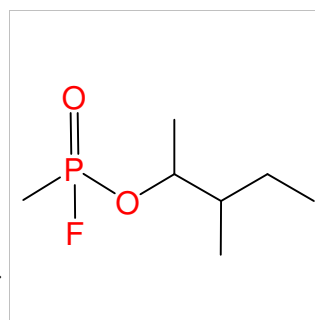

**Chemical name:** 1-Ethyl-2-methylpentyl methylphosphonofluoridate

Schedule: 1A01

CAS RN: 1005240-09-4

HS code: 2931.39

Key: 1005240-09-4

Molecular formula: C<sub>9</sub>H<sub>20</sub>FO<sub>2</sub>P

CAS Index Name: Phosphonofluoridic acid, methyl-, 1-ethyl-2-methylpentyl ester

**IUPAC name:** 1-Ethyl-2-methylpentyl methylphosphonofluoridoate

Synonyms: Phosphonofluoridic acid, methyl-, 4-methylhept-3-yl ester

O-1-Ethyl-2-methylpentyl methylphosphonofluoridate

4-Methylheptan-3-yl methylphosphonofluoridate

4-Methylhept-3-yl methylphosphonofluoridate

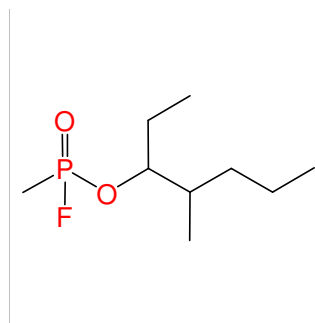

**Chemical name:** 2-tert-Butylcyclohexyl methylphosphonofluoridate

Schedule: 1A01

CAS RN: 1005247-52-8

HS code: 2931.39

Key: 1005247-52-8

Molecular formula: C<sub>11</sub>H<sub>22</sub>FO<sub>2</sub>P

CAS Index Name: Phosphonofluoridic acid, methyl-, 2-(1,1-dimethylethyl)cyclohexyl ester

**IUPAC name:** 2-tert-Butylcyclohexyl methylphosphonofluoridoate

Synonyms: O-2-tert-Butylcyclohexyl methylphosphonofluoridate

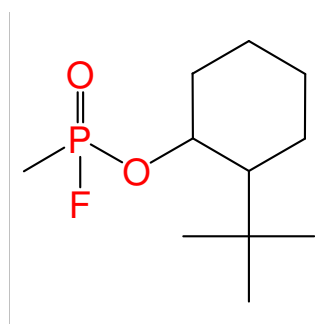

**Chemical name:** 1,2-Dimethylbutyl isopropylphosphonofluoridate

Schedule: 1A01

CAS RN: 1005249-16-0

HS code: 2931.39

Key: 1005249-16-0

Molecular formula: C<sub>9</sub>H<sub>20</sub>FO<sub>2</sub>P

CAS Index Name: Phosphonofluoridic acid, 1-methylethyl-, 1,2-dimethylbutyl ester

**IUPAC name:** 1,2-Dimethylbutyl isopropylphosphonofluoridoate

Synonyms: Phosphonofluoridic acid, 1-methylethyl-, 3-methylpent-2-yl ester

O-1,2-Dimethylbutyl isopropylphosphonofluoridate

3-Methylpentan-2-yl isopropylphosphonofluoridate

3-Methylpent-2-yl isopropylphosphonofluoridate

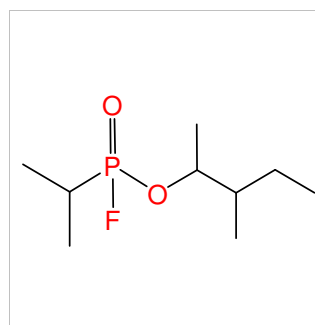

**Chemical name:** 2-tert-Butylcyclohexyl ethylphosphonofluoridate

Schedule: 1A01

CAS RN: 1005254-23-8

HS code: 2931.39

Key: 1005254-23-8

Molecular formula: C<sub>12</sub>H<sub>24</sub>FO<sub>2</sub>P

CAS Index Name: Phosphonofluoridic acid, ethyl-, 2-(1,1-dimethylethyl)cyclohexyl ester

**IUPAC name:** 2-tert-Butylcyclohexyl ethylphosphonofluoridate

Synonyms: O-2-tert-Butylcyclohexyl ethylphosphonofluoridate

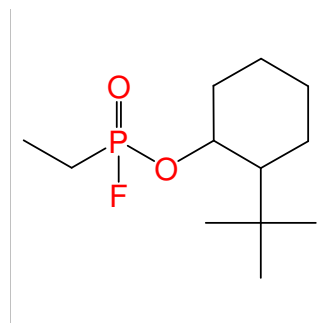

**Chemical name:** 2-Ethylcyclohexyl methylphosphonofluoridate

Schedule: 1A01

CAS RN: 1005257-56-6

HS code: 2931.39

Key: 1005257-56-6

Molecular formula: C<sub>9</sub>H<sub>18</sub>FO<sub>2</sub>P

CAS Index Name: Phosphonofluoridic acid, methyl-, 2-ethylcyclohexyl ester

**IUPAC name:** 2-Ethylcyclohexyl methylphosphonofluoridate

Synonyms: O-2-Ethylcyclohexyl methylphosphonofluoridate

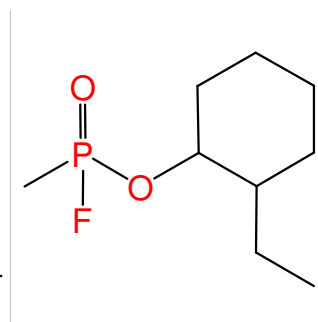

**Chemical name:** 1,2-Dimethylbutyl ethylphosphonofluoridate

Schedule: 1A01

CAS RN: 1005258-27-4

HS code: 2931.39

Key: 1005258-27-4

Molecular formula: C<sub>8</sub>H<sub>18</sub>FO<sub>2</sub>P

CAS Index Name: Phosphonofluoridic acid, ethyl-, 1,2-dimethylbutyl ester

**IUPAC name:** 1,2-Dimethylbutyl ethylphosphonofluoridate

Synonyms: Phosphonofluoridic acid, ethyl-, 3-methylpent-2-yl ester

O-1,2-Dimethylbutyl ethylphosphonofluoridate

3-Methylpentan-2-yl ethylphosphonofluoridate

3-Methylpent-2-yl ethylphosphonofluoridate

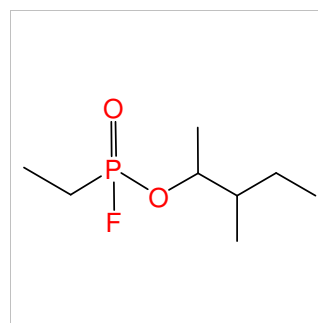

**Chemical name:** 2,6-Dimethylcyclohexyl methylphosphonofluoridate

Schedule: 1A01

CAS RN: 1005276-38-9

HS code: 2931.39

Key: 1005276-38-9

Molecular formula: C<sub>9</sub>H<sub>18</sub>FO<sub>2</sub>P

CAS Index Name: Phosphonofluoridic acid, methyl-, 2,6-dimethylcyclohexyl ester

**IUPAC name:** 2,6-Dimethylcyclohexyl methylphosphonofluoridate

Synonyms: O-2,6-Dimethylcyclohexyl methylphosphonofluoridate

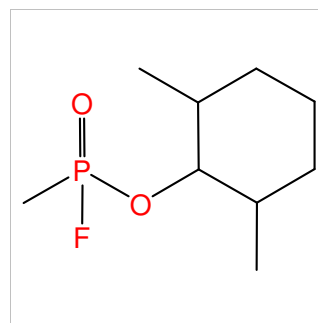

**Chemical name:** 3,5-Dimethylcyclohexyl methylphosphonofluoridate

Schedule: 1A01

CAS RN: 1005284-61-6

HS code: 2931.39

Key: 1005284-61-6

Molecular formula: C<sub>9</sub>H<sub>18</sub>FO<sub>2</sub>P

CAS Index Name: Phosphonofluoridic acid, methyl-, 3,5-dimethylcyclohexyl ester

**IUPAC name:** 3,5-Dimethylcyclohexyl methylphosphonofluoridoate

Synonyms: O-3,5-Dimethylcyclohexyl methylphosphonofluoridate

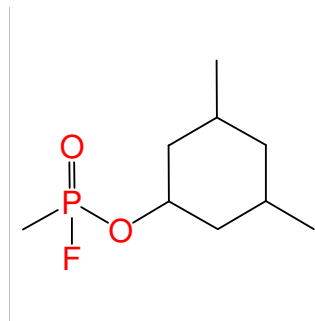

**Chemical name:** Isopropyl methyl-[14C]-phosphonofluoridate

Schedule: 1A01

CAS RN: 104800-97-7

HS code: 2845.90

Key: 104800-97-7

Molecular formula: C<sub>3</sub> <sup>14</sup>C H<sub>10</sub>FO<sub>2</sub>P

CAS Index Name: Phosphonofluoridic acid, methyl-<sup>14</sup>C-, 1-methylethyl ester

**IUPAC name:** Isopropyl (14C)methylphosphonofluoridoate

Synonyms: Propan-2-yl methyl-[<sup>14</sup>C]-phosphonofluoridate

O-Isopropyl methyl-[<sup>14</sup>C]-phosphonofluoridate

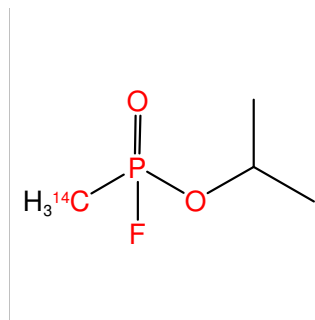

**Chemical name:** Pinacolyl methyl-[14C]-phosphonofluoridate

Schedule: 1A01

CAS RN: 104800-98-8

HS code: 2845.90

Key: 104800-98-8

Molecular formula: C<sub>6</sub> <sup>14</sup>C H<sub>16</sub>FO<sub>2</sub>P

CAS Index Name: Phosphonofluoridic acid, methyl-<sup>14</sup>C-, 1,2,2-trimethylpropyl ester

**IUPAC name:** 1,2,2-Trimethylpropyl (14C)methylphosphonofluoridoate

Synonyms: O-Pinacolyl methyl-[<sup>14</sup>C]-phosphonofluoridate

3,3-Dimethylbutan-2-yl methyl-[<sup>14</sup>C]-phosphonofluoridate

1,2,2-Trimethylpropyl (14C)methylphosphonofluoridate

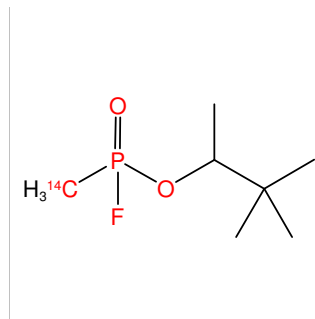

**Chemical name:** Isopropyl methylphosphonofluoridate, labeled with tritium (Tritium at unspecified locations)

Schedule: 1A01

CAS RN: 104801-07-2

HS code: 2844.40

Key: 104801-07-2

Molecular formula: C<sub>4</sub>H<sub>(10-x)</sub>T<sub>x</sub>FO<sub>2</sub>P

CAS Index Name: Phosphonofluoridic acid, methyl-, 1-methylethyl ester, labeled with tritium

**IUPAC name:**

Synonyms:

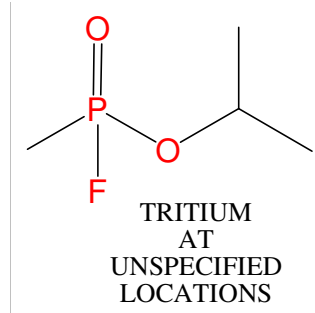

**Chemical name:** Isopropyl methyl-d<sub>3</sub>-phosphonofluoridate

Schedule: 1A01

CAS RN: 104801-08-3

HS code: 2845.90

Key: 104801-08-3

Molecular formula: C<sub>4</sub>H<sub>7</sub>D<sub>3</sub>FO<sub>2</sub>P

CAS Index Name: Phosphonofluoridic acid, methyl-d<sub>3</sub>-, 1-methylethyl ester

**IUPAC name:** Isopropyl methyl-d<sub>3</sub>-phosphonofluoridate

Synonyms: O-Isopropyl trideuteriomethylphosphonofluoridate

O-Isopropyl methyl-d<sub>3</sub>-phosphonofluoridate

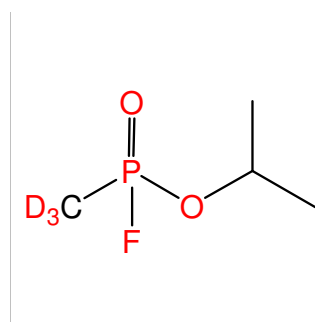

**Chemical name:** Pinacolyl methyl-d<sub>3</sub>-phosphonofluoridate

Schedule: 1A01

CAS RN: 104801-09-4

HS code: 2845.90

Key: 104801-09-4

Molecular formula: C<sub>7</sub>H<sub>13</sub>D<sub>3</sub>FO<sub>2</sub>P

CAS Index Name: Phosphonofluoridic acid, methyl-d<sub>3</sub>-, 1,2,2-trimethylpropyl ester

**IUPAC name:** 1,2,2-Trimethylpropyl methyl-d<sub>3</sub>-phosphonofluoridate

Synonyms: O-Pinacolyl methyl-d<sub>3</sub>-phosphonofluoridate

3,3-Dimethylbutan-2-yl methyl-d<sub>3</sub>-phosphonofluoridate

3,3-Dimethylbut-2-yl methyl-d<sub>3</sub>-phosphonofluoridate

1,2,2-Trimethylpropyl methyl-d<sub>3</sub>-phosphonofluoridate

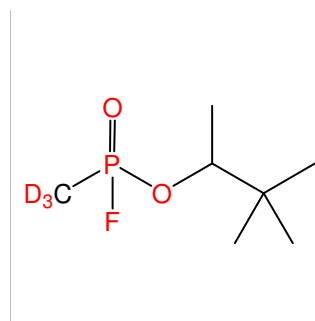

**Chemical name:** Pinacolyl methylphosphonofluoridate, labeled with tritium (Tritium at unspecified locations)(Isotopes at unknown locations)

Schedule: 1A01

CAS RN: 104801-10-7

HS code: 2844.40

Key: 104801-10-7

Molecular formula:  $C_7H_{(16-x)}T_xFO_2P$

CAS Index Name: Phosphonofluoridic acid, methyl-, 1,2,2-trimethylpropyl ester, labelled with tritium

**IUPAC name:**

Synonyms:

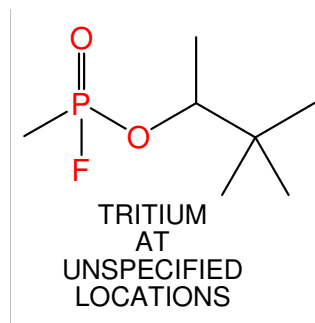

**Chemical name:** Isopropyl methylphosphonofluoridate

Schedule: 1A01

CAS RN: 107-44-8

HS code: 2931.39

Key: 107-44-8

Molecular formula:  $C_4H_{10}FO_2P$

CAS Index Name: Phosphonofluoridic acid, methyl-, 1-methylethyl ester

**IUPAC name:** Isopropyl methylphosphonofluoridate

Synonyms: Sarin

Phosphonofluoridic acid, methyl-, isopropyl ester

O-Isopropyl methylphosphonofluoridate

O-Isopropyl methylfluorophosphonate

Methylphosphonofluoridic acid isopropyl ester

Methylfluorophosphoric acid isopropyl ester

Isopropyl methylfluorophosphonate

Isopropoxymethylphosphoryl fluoride

IMPF

GB

1-Methylethyl methylphosphonofluoridate

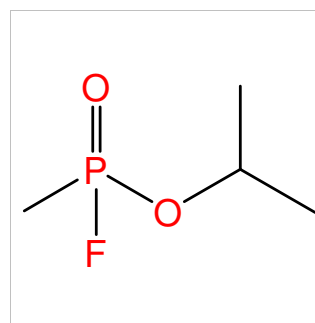



**Chemical name:** Pinacolyl-d13 methylphosphonofluoridate

Schedule: 1A01

CAS RN: 108202-65-9

HS code: 2845.90

Key: 108202-65-9

Molecular formula: C<sub>7</sub>H<sub>3</sub>D<sub>13</sub>FO<sub>2</sub>P

CAS Index Name: Phosphonofluoridic acid, methyl-, 1,2,2-tri(methyl-d3)propyl-1,3,3,3-d4 ester

**IUPAC name:** Pinacolyl-d13 methylphosphonofluoridoate

Synonyms: O-Tridecadeuteriopinacolyl methylphosphonofluoridate

O-Pinacolyl-d13 methylphosphonofluoridate

3,3-Dimethylbutan-2-yl-d13 methylphosphonofluoridate

3,3-Dimethylbut-2-yl-d13 methylphosphonofluoridate

1,2,2-Trimethylpropyl-d13 methylphosphonofluoridate

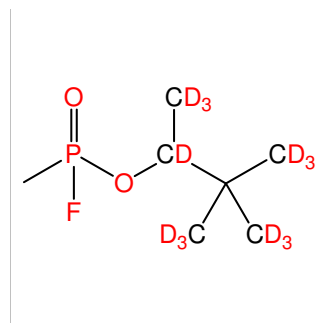

**Chemical name:** 1-Isopropyl-2-methylpropyl methylphosphonofluoridate

Schedule: 1A01

CAS RN: 113548-85-9

HS code: 2931.39

Key: 113548-85-9

Molecular formula: C<sub>8</sub>H<sub>18</sub>FO<sub>2</sub>P

CAS Index Name: Phosphonofluoridic acid, methyl-, 1-(1-methylethyl)-2-methylpropyl ester

**IUPAC name:** 1-Isopropyl-2-methylpropyl methylphosphonofluoridoate

Synonyms: O-1-Isopropyl-2-methylpropyl methylphosphonofluoridate

2,4-Dimethylpentan-3-yl methylphosphonofluoridate

2,4-Dimethylpent-3-yl methylphosphonofluoridate

1-(1-methylethyl)-2-methylpropyl methylphosphonofluoridate

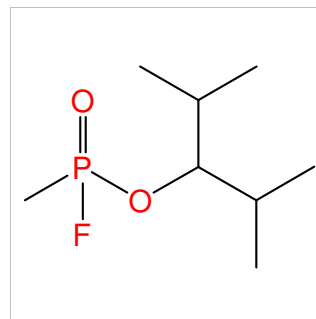

**Chemical name:** 3-Methylcyclohexyl methylphosphonofluoridate

Schedule: 1A01

CAS RN: 113548-86-0

HS code: 2931.39

Key: 113548-86-0

Molecular formula: C<sub>8</sub>H<sub>16</sub>FO<sub>2</sub>P

CAS Index Name: Phosphonofluoridic acid, methyl-, 3-methylcyclohexyl ester

**IUPAC name:** 3-Methylcyclohexyl methylphosphonofluoridoate

Synonyms: O-3-Methylcyclohexyl methylphosphonofluoridate

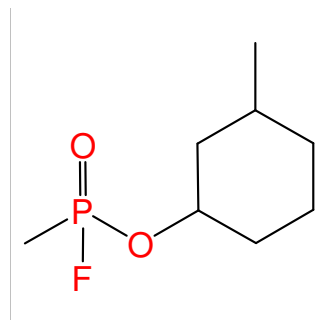

**Chemical name:** 4-Methylcyclohexyl methylphosphonofluoridate

Schedule: 1A01

CAS RN: 113548-87-1

HS code: 2931.39

Key: 113548-87-1

Molecular formula: C<sub>8</sub>H<sub>16</sub>FO<sub>2</sub>P

CAS Index Name: Phosphonofluoridic acid, methyl-, 4-methylcyclohexyl ester

**IUPAC name:** 4-Methylcyclohexyl methylphosphonofluoridate

Synonyms: O-4-Methylcyclohexyl methylphosphonofluoridate

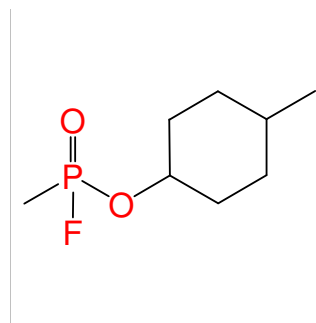

**Chemical name:** Hexyl methylphosphonofluoridate

Schedule: 1A01

CAS RN: 113548-89-3

HS code: 2931.39

Key: 113548-89-3

Molecular formula: C<sub>7</sub>H<sub>16</sub>FO<sub>2</sub>P

CAS Index Name: Phosphonofluoridic acid, methyl-, hexyl ester

**IUPAC name:** Hexyl methylphosphonofluoridate

Synonyms: O-Hexyl methylphosphonofluoridate

n-Hexyl methylphosphonofluoridate

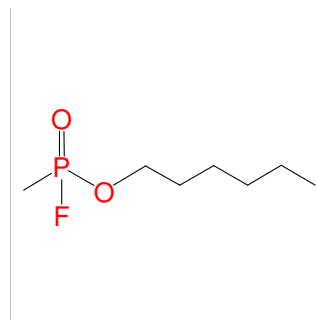

**Chemical name:** Methyl P(S)-methylphosphonofluoridate

Schedule: 1A01

CAS RN: 1187548-67-9

HS code: 2931.39

Key: 1187548-67-9

Molecular formula: C<sub>2</sub>H<sub>6</sub>FO<sub>2</sub>P

CAS Index Name: Phosphonofluoridic acid, P-methyl-, methyl ester, [P(S)]-

**IUPAC name:**

Synonyms:

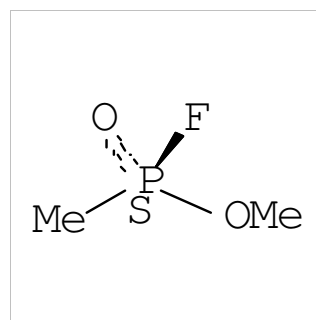

**Chemical name:** Isopropyl ethylphosphonofluoridate

Schedule: 1A01

CAS RN: 1189-87-3

HS code: 2931.39

Key: 1189-87-3

Molecular formula: C<sub>5</sub>H<sub>12</sub>FO<sub>2</sub>P

CAS Index Name: Phosphonofluoridic acid, ethyl-, 1-methylethyl ester

**IUPAC name:** Isopropyl ethylphosphonofluoridoate

Synonyms: Phosphonofluoridic acid, ethyl-, isopropyl ester

O-Isopropyl ethylphosphonofluoridate

Isopropyl ethylfluorophosphonate

Isopropyl ethylfluorophosphinate

GE

Ethylsarin

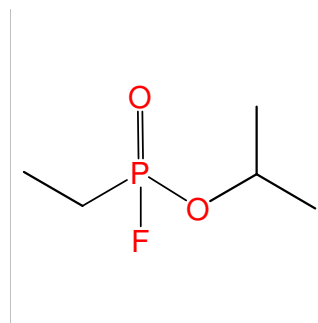

**Chemical name:** 1-Ethylhexyl methylphosphonofluoridate

Schedule: 1A01

CAS RN: 1228786-49-9

HS code: 2931.39

Key: 1228786-49-9

Molecular formula: C<sub>9</sub>H<sub>20</sub>FO<sub>2</sub>P

CAS Index Name: Phosphonofluoridic acid, methyl-, 1-ethylhexyl ester

**IUPAC name:** 1-Ethylhexyl methylphosphonofluoridoate

Synonyms: Octan-3-yl methylphosphonofluoridate

Oct-3-yl methylphosphonofluoridate

O-1-Ethylhexyl methylphosphonofluoridate

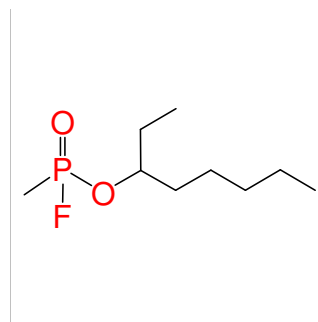

**Chemical name:** 2-Methyloctyl methylphosphonofluoridate

Schedule: 1A01

CAS RN: 1228786-50-2

HS code: 2931.39

Key: 1228786-50-2

Molecular formula: C<sub>10</sub>H<sub>22</sub>FO<sub>2</sub>P

CAS Index Name: Phosphonofluoridic acid, methyl-, 2-methyloctyl ester

**IUPAC name:**

Synonyms:

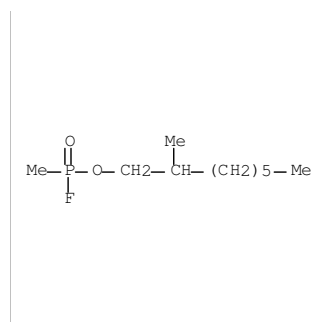

**Chemical name:** 1-Methylnonyl ethylphosphonofluoridate

Schedule: 1A01

CAS RN: 1254104-37-4

HS code: 2931.39

Key: 1254104-37-4

Molecular formula: C<sub>12</sub>H<sub>26</sub>FO<sub>2</sub>P

CAS Index Name: Phosphonofluoridic acid, ethyl-, 1-methylnonyl ester

**IUPAC name:** 1-Methylnonyl ethylphosphonofluoridoate

Synonyms: O-1-Methylnonyl ethylphosphonofluoridate

Decan-2-yl ethylphosphonofluoridate

Dec-2-yl ethylphosphonofluoridate

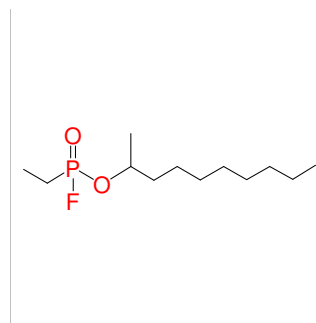

**Chemical name:** 2-Ethylbutyl methylphosphonofluoridate

Schedule: 1A01

CAS RN: 126204-48-6

HS code: 2931.39

Key: 126204-48-6

Molecular formula: C<sub>7</sub>H<sub>16</sub>FO<sub>2</sub>P

CAS Index Name: Phosphonofluoridic acid, methyl-, 2-ethylbutyl ester

**IUPAC name:** 2-Ethylbutyl methylphosphonofluoridoate

Synonyms: O-2-Ethylbutyl methylphosphonofluoridate

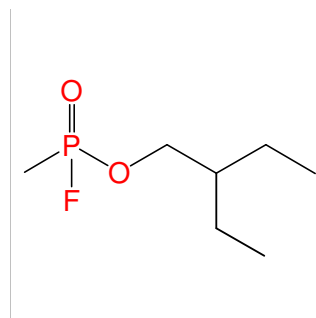

**Chemical name:** 2-Isopropyl-5-methylcyclohexyl  
methylphosphonofluoridate

Schedule: 1A01

CAS RN: 1262582-99-9

HS code: 2931.39

Key: 1262582-99-9

Molecular formula: C<sub>11</sub>H<sub>22</sub>FO<sub>2</sub>P

CAS Index Name: Phosphonofluoridic acid, methyl-, 2-(1-methylethyl)-5-methylcyclohexyl ester

**IUPAC name:** 2-Isopropyl-5-methylcyclohexyl  
methylphosphonofluoridoate

Synonyms: O-2-Isopropyl-5-methylcyclohexyl methylphosphonofluoridate

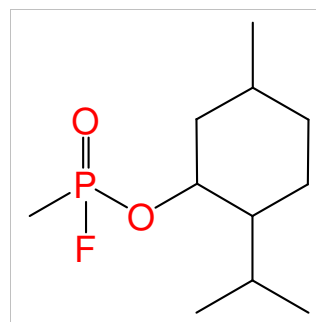

**Chemical name:** 2-Isopropyl-5-methylcyclohexyl isopropylphosphonofluoridate

Schedule: 1A01

CAS RN: 1262583-00-5

HS code: 2931.39

Key: 1262583-00-5

Molecular formula: C<sub>13</sub>H<sub>26</sub>FO<sub>2</sub>P

CAS Index Name: Phosphonofluoric acid, 1-methylethyl-, 5-methyl-2-(1-methylethyl)cyclohexyl ester

**IUPAC name:**

Synonyms:

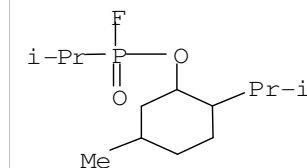

**Chemical name:** 1-Methylnonyl isopropylphosphonofluoridate

Schedule: 1A01

CAS RN: 1280106-25-3

HS code: 2931.39

Key: 1280106-25-3

Molecular formula: C<sub>13</sub>H<sub>28</sub>FO<sub>2</sub>P

CAS Index Name: Phosphonofluoric acid, 1-methylethyl-, 1-methylnonyl ester

**IUPAC name:** 1-Methylnonyl isopropylphosphonofluoridate

Synonyms: O-1-Methylnonyl isopropylphosphonofluoridate

Decan-2-yl isopropylphosphonofluoridate

Dec-2-yl isopropylphosphonofluoridate

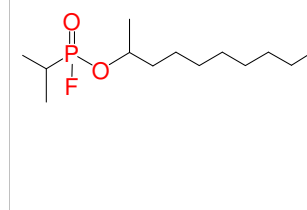

**Chemical name:** 3-Cyclohexylpropyl propylphosphonofluoridate

Schedule: 1A01

CAS RN: 1280106-26-4

HS code: 2931.39

Key: 1280106-26-4

Molecular formula: C<sub>12</sub>H<sub>24</sub>FO<sub>2</sub>P

CAS Index Name: Phosphonofluoric acid, propyl-, 3-cyclohexylpropyl ester

**IUPAC name:** 3-Cyclohexylpropyl propylphosphonofluoridate

Synonyms: O-3-Cyclohexylpropyl propylphosphonofluoridate

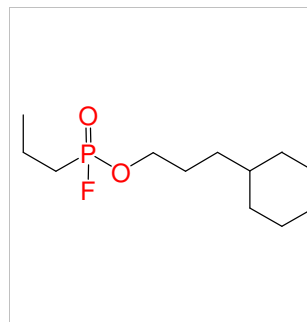

**Chemical name:** 1-Cyclohexylethyl methylphosphonofluoridate

Schedule: 1A01

CAS RN: 1280106-29-7

HS code: 2931.39

Key: 1280106-29-7

Molecular formula: C<sub>9</sub>H<sub>18</sub>FO<sub>2</sub>P

CAS Index Name: Phosphonofluoridic acid, methyl-, 1-cyclohexylethyl ester

**IUPAC name:** 1-Cyclohexylethyl methylphosphonofluoridoate

Synonyms: O-1-Cyclohexylethyl methylphosphonofluoridate

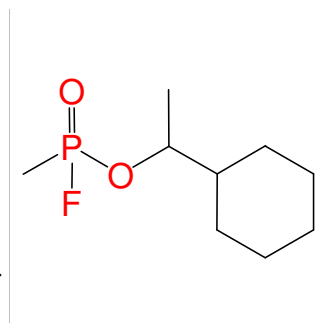

**Chemical name:** 1-Cyclohexylethyl propylphosphonofluoridate

Schedule: 1A01

CAS RN: 1280106-32-2

HS code: 2931.39

Key: 1280106-32-2

Molecular formula: C<sub>11</sub>H<sub>22</sub>FO<sub>2</sub>P

CAS Index Name: Phosphonofluoridic acid, propyl-, 1-cyclohexylethyl ester

**IUPAC name:** 1-Cyclohexylethyl propylphosphonofluoridoate

Synonyms: O-1-Cyclohexylethyl propylphosphonofluoridate

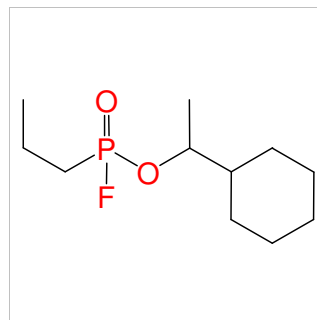

**Chemical name:** 1-Ethyl-2-methylpentyl ethylphosphonofluoridate

Schedule: 1A01

CAS RN: 1280106-33-3

HS code: 2931.39

Key: 1280106-33-3

Molecular formula: C<sub>10</sub>H<sub>22</sub>FO<sub>2</sub>P

CAS Index Name: Phosphonofluoridic acid, ethyl-, 1-ethyl-2-methylpentyl ester

**IUPAC name:** 1-Ethyl-2-methylpentyl ethylphosphonofluoridoate

Synonyms: Phosphonofluoridic acid, ethyl-, 4-methylhept-3-yl ester

O-4-Methylhept-3-yl ethylphosphonofluoridate

O-1-Ethyl-2-methylpentyl ethylphosphonofluoridate

4-Methylheptan-3-yl ethylphosphonofluoridate

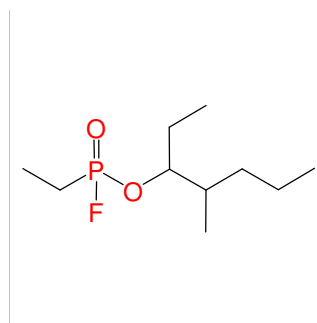

**Chemical name:** 1-Ethyl-2-methylpentyl propylphosphonofluoridate

Schedule: 1A01

CAS RN: 1280106-34-4

HS code: 2931.39

Key: 1280106-34-4

Molecular formula: C<sub>11</sub>H<sub>24</sub>FO<sub>2</sub>P

CAS Index Name: Phosphonofluoridic acid, propyl-, 1-ethyl-2-methylpentyl ester

**IUPAC name:** 1-Ethyl-2-methylpentyl propylphosphonofluoridoate

Synonyms: Phosphonofluoridic acid, propyl-, 4-methylhept-3-yl ester

O-1-Ethyl-2-methylpentyl propylphosphonofluoridate

4-Methylheptan-3-yl propylphosphonofluoridate

4-Methylhept-3-yl propylphosphonofluoridate

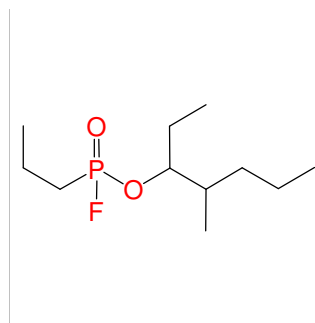

**Chemical name:** 2,3-Dimethylcyclohexyl propylphosphonofluoridate

Schedule: 1A01

CAS RN: 1280106-35-5

HS code: 2931.39

Key: 1280106-35-5

Molecular formula: C<sub>11</sub>H<sub>22</sub>FO<sub>2</sub>P

CAS Index Name: Phosphonofluoridic acid, propyl-, 2,3-dimethylcyclohexyl ester

**IUPAC name:** 2,3-Dimethylcyclohexyl propylphosphonofluoridoate

Synonyms: O-2,3-Dimethylcyclohexyl propylphosphonofluoridate

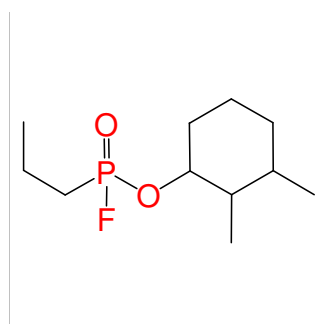

**Chemical name:** 3-Methylcyclopentyl ethylphosphonofluoridate

Schedule: 1A01

CAS RN: 1280106-36-6

HS code: 2931.39

Key: 1280106-36-6

Molecular formula: C<sub>8</sub>H<sub>16</sub>FO<sub>2</sub>P

CAS Index Name: Phosphonofluoridic acid, ethyl-, 3-methylcyclopentyl ester

**IUPAC name:** 3-Methylcyclopentyl ethylphosphonofluoridoate

Synonyms: O-3-Methylcyclopentyl ethylphosphonofluoridate

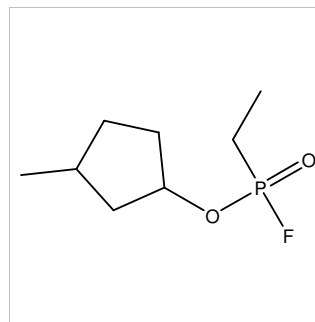

**Chemical name:** Cyclohexyl P(S)-methylphosphonofluoridate

Schedule: 1A01

CAS RN: 1280199-59-8

HS code: 2931.39

Key: 1280199-59-8

Molecular formula: C<sub>7</sub>H<sub>14</sub>FO<sub>2</sub>P

CAS Index Name: Phosphonofluoridic acid, P-methyl-, cyclohexyl ester, [P(S)]-

**IUPAC name:**

Synonyms:

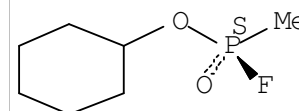

**Chemical name:** Cyclohexyl P(R)-methylphosphonofluoridate

Schedule: 1A01

CAS RN: 1280199-60-1

HS code: 2931.39

Key: 1280199-60-1

Molecular formula: C<sub>7</sub>H<sub>14</sub>FO<sub>2</sub>P

CAS Index Name: Phosphonofluoridic acid, P-methyl-, cyclohexyl ester, [P(R)]-

**IUPAC name:**

Synonyms:

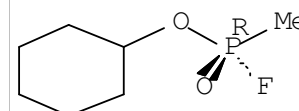

**Chemical name:** 1-Methylpentyl methylphosphonofluoridate

Schedule: 1A01

CAS RN: 13172-12-8

HS code: 2931.39

Key: 13172-12-8

Molecular formula: C<sub>7</sub>H<sub>16</sub>FO<sub>2</sub>P

CAS Index Name: Phosphonofluoridic acid, methyl-, 1-methylpentyl ester

**IUPAC name:** 1-Methylpentyl methylphosphonofluoridoate

Synonyms: O-1-Methylpentyl methylphosphonofluoridate

Hexan-2-yl methylphosphonofluoridate

Hex-2-yl methylphosphonofluoridate

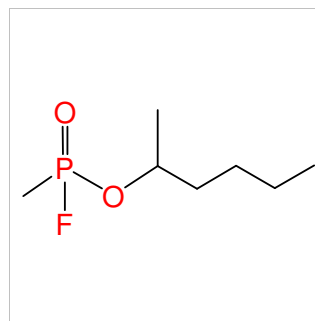



**Chemical name:** tert-Butyl methylphosphonofluoridate

Schedule: 1A01

CAS RN: 13273-12-6

HS code: 2931.39

Key: 13273-12-6

Molecular formula: C<sub>5</sub>H<sub>12</sub>FO<sub>2</sub>P

CAS Index Name: Phosphonofluoridic acid, methyl-, 1,1-dimethylethyl ester

**IUPAC name:** tert-Butyl methylphosphonofluoridoate

Synonyms: t-Butyl methylphosphonofluoridate

Phosphonofluoridic acid, methyl-, tert-butyl ester

O-tert-Butyl methylphosphonofluoridate

2-Methylpropan-2-yl methylphosphonofluoridate

2-Methylprop-2-yl methylphosphonofluoridate

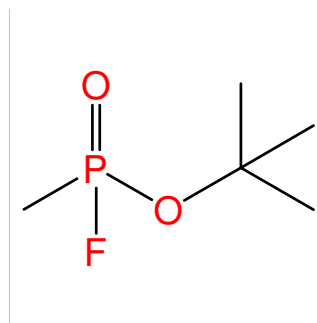

**Chemical name:** Pentyl methylphosphonofluoridate

Schedule: 1A01

CAS RN: 13454-59-6

HS code: 2931.39

Key: 13454-59-6

Molecular formula: C<sub>6</sub>H<sub>14</sub>FO<sub>2</sub>P

CAS Index Name: Phosphonofluoridic acid, methyl-, pentyl ester

**IUPAC name:** Pentyl methylphosphonofluoridoate

Synonyms: O-Pentyl methylphosphonofluoridate

n-Pentyl methylphosphonofluoridate

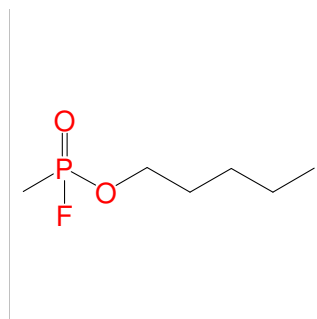

**Chemical name:** Cyclopentylmethyl ethylphosphonofluoridate

Schedule: 1A01

CAS RN: 1353011-72-9

HS code: 2931.39

Key: 1353011-72-9

Molecular formula: C<sub>8</sub>H<sub>16</sub>FO<sub>2</sub>P

CAS Index Name: Phosphonofluoridic acid, ethyl-, cyclopentylmethyl ester

**IUPAC name:** Cyclopentylmethyl ethylphosphonofluoridoate

Synonyms: O-Cyclopentylmethyl ethylphosphonofluoridate

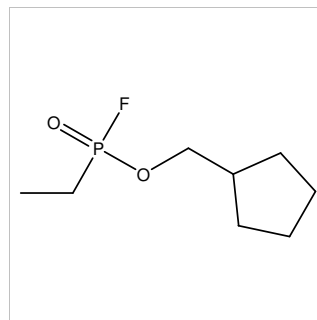

**Chemical name:** 2-Methylcyclohexyl ethylphosphonofluoridate

Schedule: 1A01

CAS RN: 1353011-76-3

HS code: 2931.39

Key: 1353011-76-3

Molecular formula: C<sub>9</sub>H<sub>18</sub>FO<sub>2</sub>P

CAS Index Name: Phosphonofluoridic acid, ethyl-, 2-methylcyclohexyl ester

**IUPAC name:** 2-Methylcyclohexyl ethylphosphonofluoridoate

Synonyms: O-2-Methylcyclohexyl ethylphosphonofluoridate

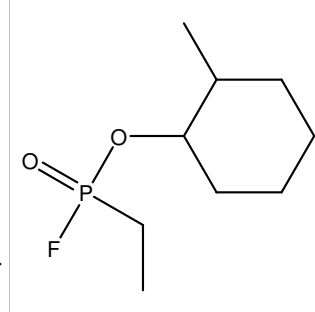

**Chemical name:** 3,5-Dimethylcyclohexyl ethylphosphonofluoridate

Schedule: 1A01

CAS RN: 1353011-80-9

HS code: 2931.39

Key: 1353011-80-9

Molecular formula: C<sub>10</sub>H<sub>20</sub>FO<sub>2</sub>P

CAS Index Name: Phosphonofluoridic acid, ethyl-, 3,5-dimethylcyclohexyl ester

**IUPAC name:** 3,5-Dimethylcyclohexyl ethylphosphonofluoridoate

Synonyms: O-3,5-Dimethylcyclohexyl ethylphosphonofluoridate

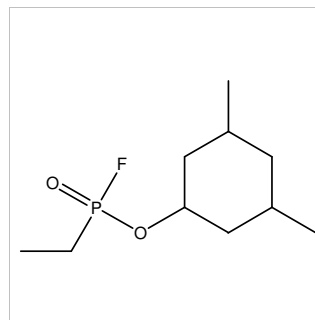

**Chemical name:** 3-Cyclopentylpropyl ethylphosphonofluoridate

Schedule: 1A01

CAS RN: 1353011-87-6

HS code: 2931.39

Key: 1353011-87-6

Molecular formula: C<sub>10</sub>H<sub>20</sub>FO<sub>2</sub>P

CAS Index Name: Phosphonofluoridic acid, ethyl-, 3-cyclopentylpropyl ester

**IUPAC name:** 3-Cyclopentylpropyl ethylphosphonofluoridoate

Synonyms: O-3-Cyclopentylpropyl ethylphosphonofluoridate

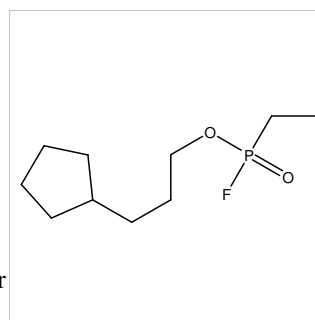

**Chemical name:** 3-Cyclohexylpropyl ethylphosphonofluoridate

Schedule: 1A01

CAS RN: 1353011-91-2

HS code: 2931.39

Key: 1353011-91-2

Molecular formula: C<sub>11</sub>H<sub>22</sub>FO<sub>2</sub>P

CAS Index Name: Phosphonofluoridic acid, ethyl-, 3-cyclohexylpropyl ester

**IUPAC name:** 3-Cyclohexylpropyl ethylphosphonofluoridoate

Synonyms: O-3-Cyclohexylpropyl ethylphosphonofluoridate

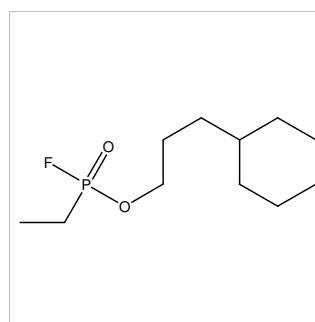

**Chemical name:** 2-Isopropyl-5-methylcyclohexyl ethylphosphonofluoridate

Schedule: 1A01

CAS RN: 1353011-93-4

HS code: 2931.39

Key: 1353011-93-4

Molecular formula: C<sub>12</sub>H<sub>24</sub>FO<sub>2</sub>P

CAS Index Name: Phosphonofluoridic acid, ethyl-, 5-methyl-2-(1-methylethyl)cyclohexyl ester

**IUPAC name:**

Synonyms:

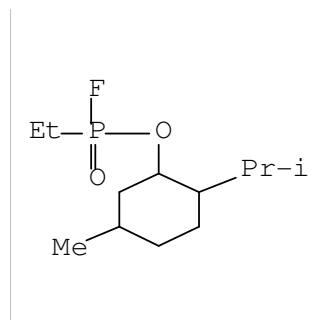

**Chemical name:** 1-Cyclohexylethyl ethylphosphonofluoridate

Schedule: 1A01

CAS RN: 1353011-94-5

HS code: 2931.39

Key: 1353011-94-5

Molecular formula: C<sub>10</sub>H<sub>20</sub>FO<sub>2</sub>P

CAS Index Name: Phosphonofluoridic acid, ethyl-, 1-cyclohexylethyl ester

**IUPAC name:** 1-Cyclohexylethyl ethylphosphonofluoridate

Synonyms: O-1-Cyclohexylethyl ethylphosphonofluoridate

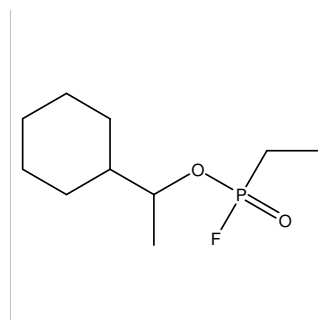

**Chemical name:** Hexyl ethylphosphonofluoridate

Schedule: 1A01

CAS RN: 135445-19-1

HS code: 2931.39

Key: 135445-19-1

Molecular formula: C<sub>8</sub>H<sub>18</sub>FO<sub>2</sub>P

CAS Index Name: Phosphonofluoridic acid, ethyl-, hexyl ester

**IUPAC name:** Hexyl ethylphosphonofluoridate

Synonyms: O-Hexyl ethylphosphonofluoridate

n-Hexyl ethylphosphonofluoridate

Hexyl ethylfluorophosphate

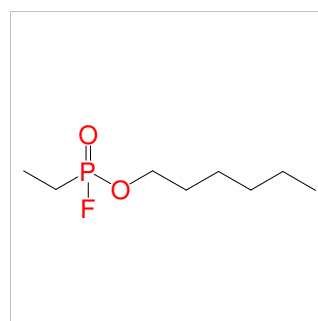

**Chemical name:** Ethyl-d5 methylphosphonofluoridate

Schedule: 1A01

CAS RN: 1401185-94-1

HS code: 2845.90

Key: 1401185-94-1

Molecular formula: C<sub>3</sub>H<sub>3</sub>D<sub>5</sub>FO<sub>2</sub>P

CAS Index Name: Phosphonofluoridic acid, P-methyl-, ethyl-1,1,2,2,2-d<sub>5</sub> ester

**IUPAC name:** Ethyl-d<sub>5</sub> methylphosphonofluoridoate

Synonyms: Pentadeuterioethyl methylphosphonofluoridate  
O-Pentadeuterioethyl methylphosphonofluoridate  
O-Ethyl-d<sub>5</sub> methylphosphonofluoridate

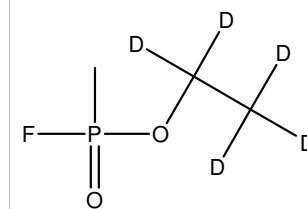

**Chemical name:** Isopropyl-d<sub>7</sub> methylphosphonofluoridate

Schedule: 1A01

CAS RN: 1401191-54-5

HS code: 2845.90

Key: 1401191-54-5

Molecular formula: C<sub>4</sub>H<sub>3</sub>D<sub>7</sub>FO<sub>2</sub>P

CAS Index Name: Phosphonofluoridic acid, methyl-, (1-methylethyl)-d<sub>7</sub> ester

**IUPAC name:** Isopropyl-d<sub>7</sub> methylphosphonofluoridoate

Synonyms: O-Isopropyl-d<sub>7</sub> methylphosphonofluoridate  
O-Heptadeuterioisopropyl methylphosphonofluoridate

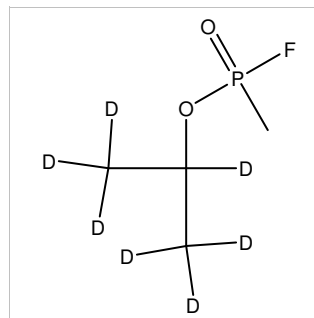

**Chemical name:** Cyclohexyl-d<sub>11</sub> methylphosphonofluoridate

Schedule: 1A01

CAS RN: 1401197-07-6

HS code: 2845.90

Key: 1401197-07-6

Molecular formula: C<sub>7</sub>H<sub>3</sub>D<sub>11</sub>FO<sub>2</sub>P

CAS Index Name: Phosphonofluoridic acid, methyl-, cyclohexyl-d<sub>11</sub> ester

**IUPAC name:** Cyclohexyl-d<sub>11</sub> methylphosphonofluoridoate

Synonyms: Undecadeuteriocyclohexyl methylphosphonofluoridate  
O-Cyclohexyl-d<sub>11</sub> methylphosphonofluoridate

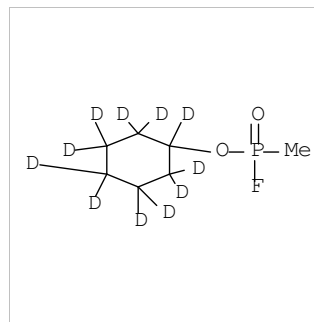

**Chemical name:** Isopropyl methylphosphonofluoridate hydrate (1:1)

Schedule: 1A01

CAS RN: 1415799-56-2

HS code: 2931.39

Key: 1415799-56-2

Molecular formula: C<sub>4</sub>H<sub>10</sub>FO<sub>2</sub>P · H<sub>2</sub>O

CAS Index Name: Phosphonofluoridic acid, P-methyl-, 1-methylethyl ester, hydrate (1:1)

**IUPAC name:**

Synonyms:

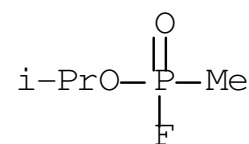

**Chemical name:** Isopropyl methylphosphonofluoridate hydrate (1:2)

Schedule: 1A01

CAS RN: 1415799-57-3

HS code: 2931.39

Key: 1415799-57-3

Molecular formula: C<sub>4</sub>H<sub>10</sub>FO<sub>2</sub>P · 2H<sub>2</sub>O

CAS Index Name: Phosphonofluoridic acid, P-methyl-, 1-methylethyl ester, hydrate (1:2)

**IUPAC name:**

Synonyms:

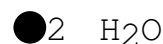
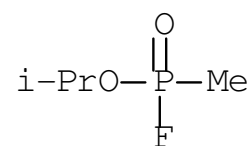

**Chemical name:** Isopropyl methylphosphonofluoridate hydrate (1:3)

Schedule: 1A01

CAS RN: 1415799-58-4

HS code: 2931.39

Key: 1415799-58-4

Molecular formula: C<sub>4</sub>H<sub>10</sub>FO<sub>2</sub>P · 3H<sub>2</sub>O

CAS Index Name: Phosphonofluoridic acid, P-methyl-, 1-methylethyl ester, hydrate (1:3)

**IUPAC name:**

Synonyms:

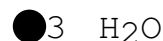
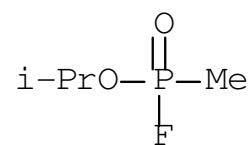

**Chemical name:** Isopropyl methylphosphonofluoridate hydrate (1:4)

Schedule: 1A01

CAS RN: 1415799-59-5

HS code: 2931.39

Key: 1415799-59-5

Molecular formula: C<sub>4</sub>H<sub>10</sub>FO<sub>2</sub>P · 4H<sub>2</sub>O

CAS Index Name: Phosphonofluoridic acid, P-methyl-, 1-methylethyl ester, hydrate (1:4)

**IUPAC name:**

Synonyms:

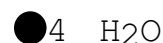
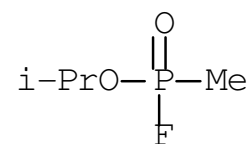

**Chemical name:** Ethyl isopropylphosphonofluoridate

Schedule: 1A01

CAS RN: 1426-08-0

HS code: 2931.39

Key: 1426-08-0

Molecular formula: C<sub>5</sub>H<sub>12</sub>FO<sub>2</sub>P

CAS Index Name: Phosphonofluoridic acid, (1-methylethyl)-, ethyl ester

**IUPAC name:** Ethyl isopropylphosphonofluoridoate

Synonyms: O-Ethyl isopropylphosphonofluoridate

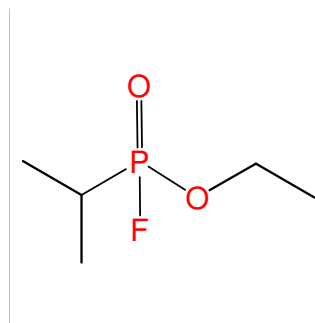

**Chemical name:** Octyl methylphosphonofluoridate

Schedule: 1A01

CAS RN: 144313-52-0

HS code: 2931.39

Key: 144313-52-0

Molecular formula: C<sub>9</sub>H<sub>20</sub>FO<sub>2</sub>P

CAS Index Name: Phosphonofluoridic acid, methyl-, octyl ester

**IUPAC name:** Octyl methylphosphonofluoridoate

Synonyms: O-Octyl methylphosphonofluoridate

n-Octyl methylphosphonofluoridate

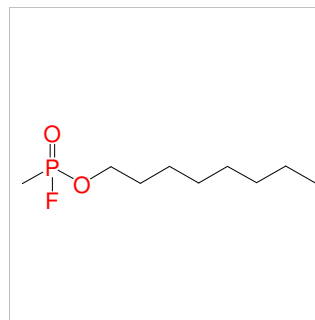

**Chemical name:** Cyclobutyl methylphosphonofluoridate

Schedule: 1A01

CAS RN: 14618-04-3

HS code: 2931.39

Key: 14618-04-3

Molecular formula: C<sub>5</sub>H<sub>10</sub>FO<sub>2</sub>P

CAS Index Name: Phosphonofluoridic acid, methyl-, cyclobutyl ester

**IUPAC name:** Cyclobutyl methylphosphonofluoridoate

Synonyms: Cyclobutanol, methylphosphonofluoridate

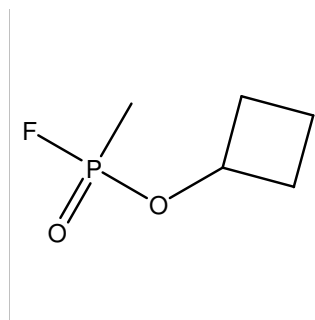

**Chemical name:** Cyclooctyl methylphosphonofluoridate

Schedule: 1A01

CAS RN: 14719-38-1

HS code: 2931.39

Key: 14719-38-1

Molecular formula: C<sub>9</sub>H<sub>18</sub>FO<sub>2</sub>P

CAS Index Name: Phosphonofluoridic acid, methyl-, cyclooctyl ester

**IUPAC name:** Cyclooctyl methylphosphonofluoridoate

Synonyms: O-Cyclooctyl methylphosphonofluoridate

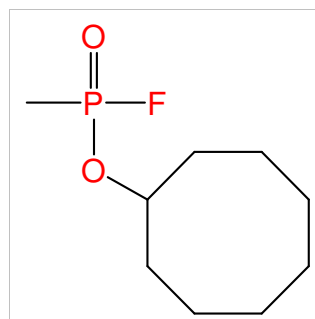

**Chemical name:** 1,5-Dimethylhexyl methylphosphonofluoridate

Schedule: 1A01

CAS RN: 159395-76-3

HS code: 2931.39

Key: 159395-76-3

Molecular formula: C<sub>9</sub>H<sub>20</sub>FO<sub>2</sub>P

CAS Index Name: Phosphonofluoridic acid, methyl-, 1,5-dimethylhexyl ester

**IUPAC name:** 1,5-Dimethylhexyl methylphosphonofluoridoate

Synonyms: O-1,5-Dimethylhexyl methylphosphonofluoridate

6-Methylheptan-2-yl methylphosphonofluoridoate

6-Methylheptan-2-yl methylphosphonofluoridate

6-Methylhept-2-yl methylphosphonofluoridate

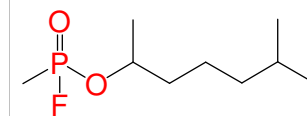

**Chemical name:** 1,1-Dimethylpropyl methylphosphonofluoridate

Schedule: 1A01

CAS RN: 159395-77-4

HS code: 2931.39

Key: 159395-77-4

Molecular formula: C<sub>6</sub>H<sub>14</sub>FO<sub>2</sub>P

CAS Index Name: Phosphonofluoridic acid, methyl-, 1,1-Dimethylpropyl ester

**IUPAC name:** 1,1-Dimethylpropyl methylphosphonofluoridoate

Synonyms: tert-Pentyl methylphosphonofluoridate

O-1,1-Dimethylpropyl methylphosphonofluoridate

2-Methylbutan-2-yl methylphosphonofluoridate

2-Methylbut-2-yl methylphosphonofluoridate

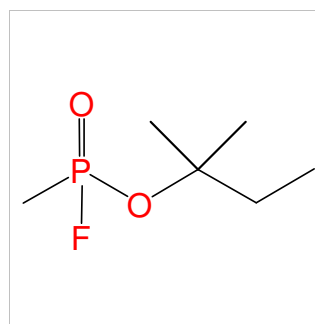

**Chemical name:** 1,1-Diethyl-2,2-dimethylpropyl  
methylphosphonofluoridate

Schedule: 1A01

CAS RN: 159395-78-5

HS code: 2931.39

Key: 159395-78-5

Molecular formula: C<sub>10</sub>H<sub>22</sub>FO<sub>2</sub>P

CAS Index Name: Phosphonofluoridic acid, methyl-, 1,1-diethyl-2,2-dimethylpropyl ester

**IUPAC name:** 3-ethyl-2,2-dimethylpentan-3-yl  
methylphosphonofluoridate

Synonyms: O-1,1-Diethyl-2,2-dimethylpropyl methylphosphonofluoridate

3-Ethyl-2,2-dimethylpentan-3-yl methylphosphonofluoridoate

3-Ethyl-2,2-dimethylpentan-3-yl methylphosphonofluoridate

3-Ethyl-2,2-dimethylpent-3-yl methylphosphonofluoridate

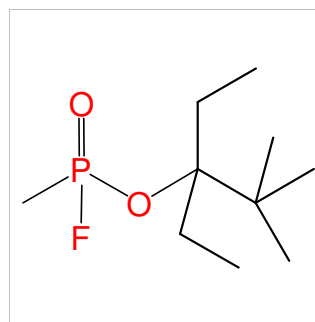

**Chemical name:** Heptyl methylphosphonofluoridate

Schedule: 1A01

CAS RN: 162085-82-7

HS code: 2931.39

Key: 162085-82-7

Molecular formula: C<sub>8</sub>H<sub>18</sub>FO<sub>2</sub>P

CAS Index Name: Phosphonofluoridic acid, methyl-, heptyl ester

**IUPAC name:** Heptyl methylphosphonofluoridoate

Synonyms: O-Heptyl methylphosphonofluoridate

n-Heptyl methylphosphonofluoridate

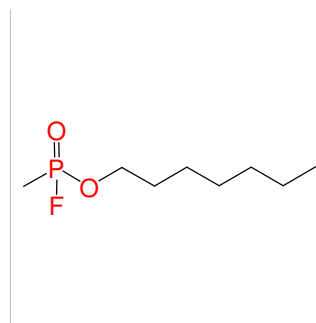

**Chemical name:** sec-Butyl ethylphosphonofluoridate

Schedule: 1A01

CAS RN: 162085-83-8

HS code: 2931.39

Key: 162085-83-8

Molecular formula: C<sub>6</sub>H<sub>14</sub>FO<sub>2</sub>P

CAS Index Name: Phosphonofluoridic acid, ethyl-, 1-methylpropyl ester

**IUPAC name:** sec-Butyl ethylphosphonofluoridoate

Synonyms: O-sec-Butyl ethylphosphonofluoridate

Butan-2-yl ethylphosphonofluoridate

But-2-yl ethylphosphonofluoridate

1-Methylpropyl ethylphosphonofluoridate

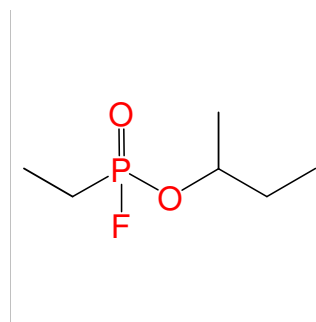

**Chemical name:** Pentyl ethylphosphonofluoridate

Schedule: 1A01

CAS RN: 162085-84-9

HS code: 2931.39

Key: 162085-84-9

Molecular formula: C<sub>7</sub>H<sub>16</sub>FO<sub>2</sub>P

CAS Index Name: Phosphonofluoridic acid, ethyl-, pentyl ester

**IUPAC name:** Pentyl ethylphosphonofluoridoate

Synonyms: O-Pentyl ethylphosphonofluoridate

n-Pentyl ethylphosphonofluoridate

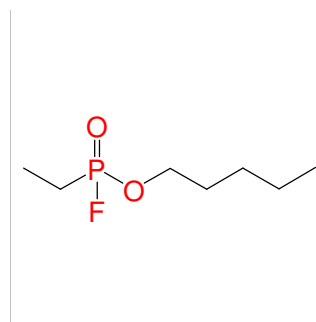



**Chemical name:** Heptyl ethylphosphonofluoridate

Schedule: 1A01

CAS RN: 162085-85-0

HS code: 2931.39

Key: 162085-85-0

Molecular formula: C<sub>9</sub>H<sub>20</sub>FO<sub>2</sub>P

CAS Index Name: Phosphonofluoridic acid, ethyl-, heptyl ester

**IUPAC name:** Heptyl ethylphosphonofluoridoate

Synonyms: O-Heptyl ethylphosphonofluoridate

n-Heptyl ethylphosphonofluoridate

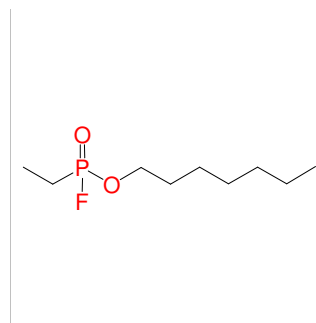

**Chemical name:** Nonyl ethylphosphonofluoridate

Schedule: 1A01

CAS RN: 171741-07-4

HS code: 2931.39

Key: 171741-07-4

Molecular formula: C<sub>11</sub>H<sub>24</sub>FO<sub>2</sub>P

CAS Index Name: Phosphonofluoridic acid, ethyl-, nonyl ester

**IUPAC name:** Nonyl ethylphosphonofluoridoate

Synonyms: O-Nonyl ethylphosphonofluoridate

n-Nonyl ethylphosphonofluoridate

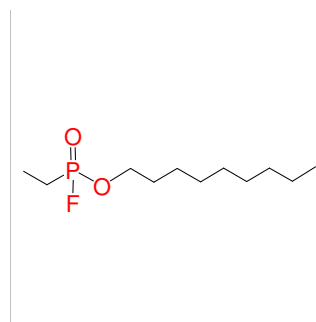

**Chemical name:** Butyl ethylphosphonofluoridate

Schedule: 1A01

CAS RN: 18358-34-4

HS code: 2931.39

Key: 18358-34-4

Molecular formula: C<sub>6</sub>H<sub>14</sub>FO<sub>2</sub>P

CAS Index Name: Phosphonofluoridic acid, ethyl-, butyl ester

**IUPAC name:** Butyl ethylphosphonofluoridoate

Synonyms: O-Butyl ethylphosphonofluoridate

n-Butyl ethylphosphonofluoridate

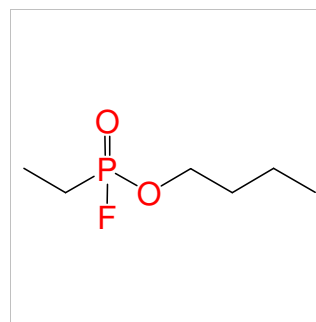

**Chemical name:** Propyl propylphosphonofluoridate

Schedule: 1A01

CAS RN: 18358-36-6

HS code: 2931.39

Key: 18358-36-6

Molecular formula: C<sub>6</sub>H<sub>14</sub>FO<sub>2</sub>P

CAS Index Name: Phosphonofluoridic acid, propyl-, propyl ester

**IUPAC name:** Propyl propylphosphonofluoridoate

Synonyms: O-Propyl propylphosphonofluoridate

n-Propyl propylphosphonofluoridate

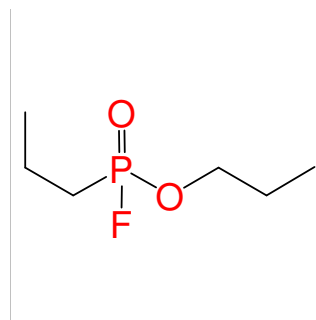

**Chemical name:** Isopropyl propylphosphonofluoridate

Schedule: 1A01

CAS RN: 18358-37-7

HS code: 2931.39

Key: 18358-37-7

Molecular formula: C<sub>6</sub>H<sub>14</sub>FO<sub>2</sub>P

CAS Index Name: Phosphonofluoridic acid, propyl-, 1-methylethyl ester

**IUPAC name:** Isopropyl propylphosphonofluoridoate

Synonyms: Phosphonofluoridic acid, propyl-, isopropyl ester

O-Isopropyl propylphosphonofluoridate

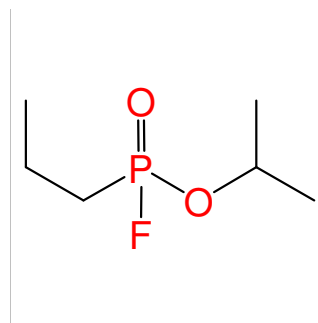

**Chemical name:** 1-Isobutyl-3-methylbutyl methylphosphonofluoridate

Schedule: 1A01

CAS RN: 193090-16-3

HS code: 2931.39

Key: 193090-16-3

Molecular formula: C<sub>10</sub>H<sub>22</sub>FO<sub>2</sub>P

CAS Index Name: Phosphonofluoridic acid, methyl-, 1-isobutyl-3-methylbutyl ester

**IUPAC name:** 1-Isobutyl-3-methylbutyl methylphosphonofluoridoate

Synonyms: Phosphonofluoridic acid, methyl-, 2,6-dimethylhept-4-yl ester

O-1-Isobutyl-3-methylbutyl methylphosphonofluoridate

2,6-Dimethylheptan-4-yl methylphosphonofluoridate

2,6-Dimethylhept-4-yl methylphosphonofluoridate

1-Isobutylisopentyl methylphosphonofluoridate

1-(2-Methylpropyl)-isopentyl methylphosphonofluoridate

1-(2-Methylpropyl)-3-methylbutyl methylphosphonofluoridate

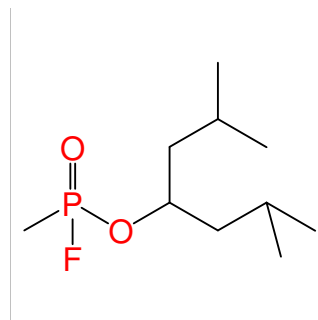

**Chemical name:** Decyl methylphosphonofluoridate

Schedule: 1A01

CAS RN: 193090-25-4

HS code: 2931.39

Key: 193090-25-4

Molecular formula: C<sub>11</sub>H<sub>24</sub>FO<sub>2</sub>P

CAS Index Name: Phosphonofluoridic acid, methyl-, decyl ester

**IUPAC name:** Decyl methylphosphonofluoridoate

Synonyms: O-Decyl methylphosphonofluoridate

n-Decyl methylphosphonofluoridate

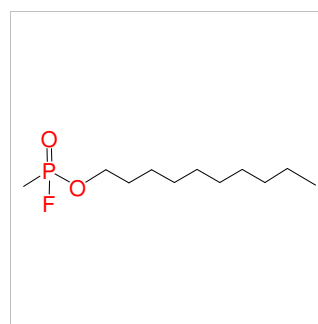

**Chemical name:** 3-Methylpentyl methylphosphonofluoridate

Schedule: 1A01

CAS RN: 199850-60-7

HS code: 2931.39

Key: 199850-60-7

Molecular formula: C<sub>7</sub>H<sub>16</sub>FO<sub>2</sub>P

CAS Index Name: Phosphonofluoridic acid, methyl-, 3-methylpentyl ester

**IUPAC name:** 3-Methylpentyl methylphosphonofluoridoate

Synonyms: O-3-Methylpentyl methylphosphonofluoridate

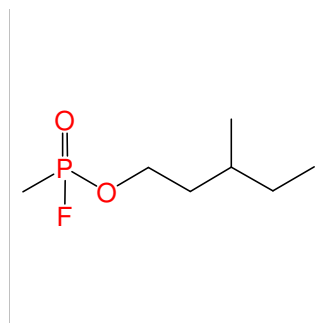

**Chemical name:** 1,4-Dimethylpentyl methylphosphonofluoridate

Schedule: 1A01

CAS RN: 199850-62-9

HS code: 2931.39

Key: 199850-62-9

Molecular formula: C<sub>8</sub>H<sub>18</sub>FO<sub>2</sub>P

CAS Index Name: Phosphonofluoridic acid, methyl-, 1,4-dimethylpentyl ester

**IUPAC name:** 1,4-Dimethylpentyl methylphosphonofluoridoate

Synonyms: Phosphonofluoridic acid, methyl-, 5-methylhex-2-yl ester

O-1,4-Dimethylpentyl methylphosphonofluoridate

5-Methylhexan-2-yl methylphosphonofluoridate

5-Methylhex-2-yl methylphosphonofluoridate

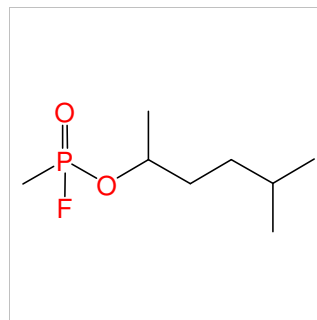

**Chemical name:** Isobutyl methylphosphonofluoridate

Schedule: 1A01

CAS RN: 2053-81-8

HS code: 2931.39

Key: 2053-81-8

Molecular formula: C<sub>5</sub>H<sub>12</sub>FO<sub>2</sub>P

CAS Index Name: Phosphonofluoridic acid, methyl-, 2-methylpropyl ester

**IUPAC name:** Isobutyl methylphosphonofluoridoate

Synonyms: Phosphonofluoridic acid, methyl-, isobutyl ester

O-Isobutyl methylphosphonofluoridate

Isobutyl fluoromethylphosphonate

2-Methylpropyl methylphosphonofluoridate

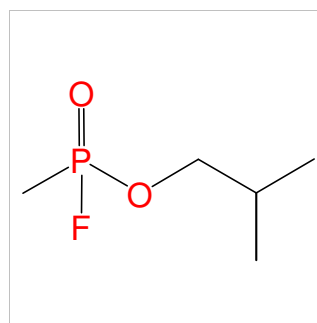

**Chemical name:** 1-Methylnonyl methylphosphonofluoridate

Schedule: 1A01

CAS RN: 211192-71-1

HS code: 2931.39

Key: 211192-71-1

Molecular formula: C<sub>11</sub>H<sub>24</sub>FO<sub>2</sub>P

CAS Index Name: Phosphonofluoridic acid, methyl-, 1-methylnonyl ester

**IUPAC name:** 1-Methylnonyl methylphosphonofluoridoate

Synonyms: O-1-Methylnonyl methylphosphonofluoridate

Decan-2-yl methylphosphonofluoridate

Dec-2-yl methylphosphonofluoridate

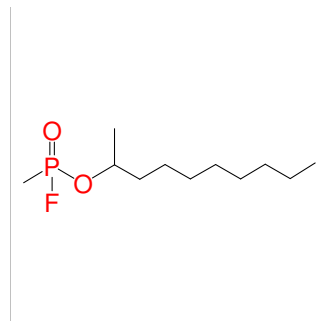

**Chemical name:** 1-Methyloctyl methylphosphonofluoridate

Schedule: 1A01

CAS RN: 211192-72-2

HS code: 2931.39

Key: 211192-72-2

Molecular formula: C<sub>10</sub>H<sub>22</sub>FO<sub>2</sub>P

CAS Index Name: Phosphonofluoridic acid, methyl-, 1-methyloctyl ester

**IUPAC name:** 1-Methyloctyl methylphosphonofluoridoate

Synonyms: Phosphonofluoridic acid, methyl-, non-2-yl ester

O-1-Methyloctyl methylphosphonofluoridate

Nonan-2-yl methylphosphonofluoridate

Non-2-yl methylphosphonofluoridate

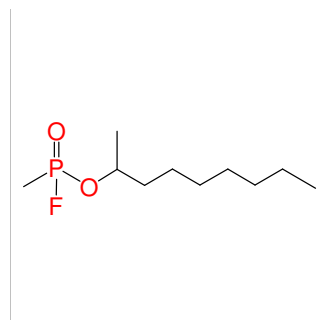

**Chemical name:** 3-Cyclohexylpropyl methylphosphonofluoridate

Schedule: 1A01

CAS RN: 211192-73-3

HS code: 2931.39

Key: 211192-73-3

Molecular formula: C<sub>10</sub>H<sub>20</sub>FO<sub>2</sub>P

CAS Index Name: Phosphonofluoridic acid, methyl-, 3-cyclohexylpropyl ester

**IUPAC name:** 3-Cyclohexylpropyl methylphosphonofluoridoate

Synonyms: O-3-Cyclohexylpropyl methylphosphonofluoridate

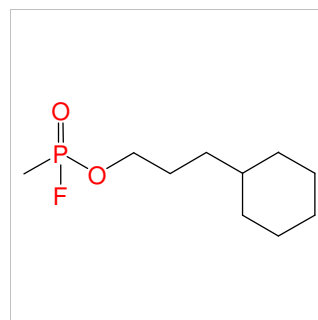

**Chemical name:** Nonyl methylphosphonofluoridate

Schedule: 1A01

CAS RN: 211192-74-4

HS code: 2931.39

Key: 211192-74-4

Molecular formula: C<sub>10</sub>H<sub>22</sub>FO<sub>2</sub>P

CAS Index Name: Phosphonofluoridic acid, methyl-, nonyl ester

**IUPAC name:** Nonyl methylphosphonofluoridoate

Synonyms: O-Nonyl methylphosphonofluoridate

n-Nonyl methylphosphonofluoridate

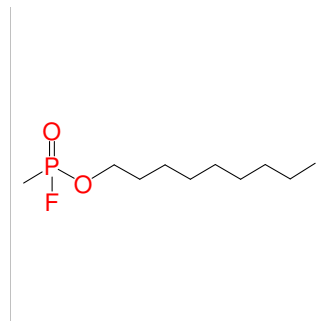

**Chemical name:** 3-Methylbutyl methylphosphonofluoridate

Schedule: 1A01

CAS RN: 22107-46-6

HS code: 2931.39

Key: 22107-46-6

Molecular formula: C<sub>6</sub>H<sub>14</sub>FO<sub>2</sub>P

CAS Index Name: Phosphonofluoridic acid, methyl-, 3-methylbutyl ester

**IUPAC name:** 3-Methylbutyl methylphosphonofluoridoate

Synonyms: O-Isopentyl methylphosphonofluoridate

O-3-Methylbutyl methylphosphonofluoridate

Isopentyl methylphosphonofluoridoate

Isopentyl methylphosphonofluoridate

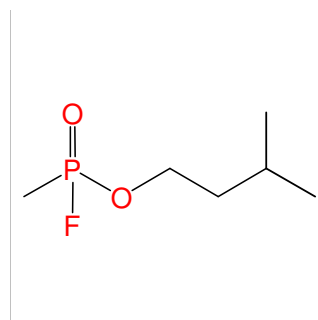

**Chemical name:** Isobutyl ethylphosphonofluoridate

Schedule: 1A01

CAS RN: 2261-83-8

HS code: 2931.39

Key: 2261-83-8

Molecular formula: C<sub>6</sub>H<sub>14</sub>FO<sub>2</sub>P

CAS Index Name: Phosphonofluoridic acid, ethyl-, 2-methylpropyl ester

**IUPAC name:** Isobutyl ethylphosphonofluoridoate

Synonyms: Phosphonofluoridic acid, ethyl-, isobutyl ester

O-Isobutyl ethylphosphonofluoridate

2-Methylpropyl ethylphosphonofluoridate

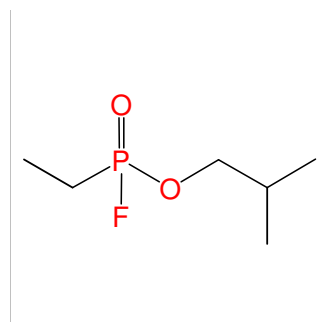

**Chemical name:** (1S)-1-Methylheptyl methylphosphonofluoridate

Schedule: 1A01

CAS RN: 22925-96-8

HS code: 2931.39

Key: 22925-96-8

Molecular formula: C<sub>9</sub>H<sub>20</sub>FO<sub>2</sub>P

CAS Index Name: Phosphonofluoridic acid, methyl-, 1-methylheptyl ester, [R-(R\*,R\*)]-

**IUPAC name:** (1S)-1-Methylheptyl methylphosphonofluoridate

Synonyms: Phosphonofluoridic acid, methyl-, 1-methylheptyl ester, (R,R)-

O-(1S)-1-Methylheptyl methylphosphonofluoridate

2-Octanol, methylphosphonofluoridate, (R,R)-

[R-(R\*,R\*)] 1-Methylheptyl methylphosphonofluoridate

(2S)-Oct-2-yl methylphosphonofluoridate

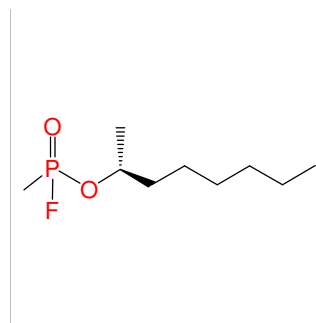

**Chemical name:** 1-Methylheptyl methylphosphonofluoridate

Schedule: 1A01

CAS RN: 22925-97-9

HS code: 2931.39

Key: 22925-97-9

Molecular formula: C<sub>9</sub>H<sub>20</sub>FO<sub>2</sub>P

CAS Index Name: Phosphonofluoridic acid, methyl-, 1-methylheptyl ester

**IUPAC name:** 1-Methylheptyl methylphosphonofluoridate

Synonyms: Octan-2-yl methylphosphonofluoridate

Oct-2-yl methylphosphonofluoridate

O-1-Methylheptyl methylphosphonofluoridate

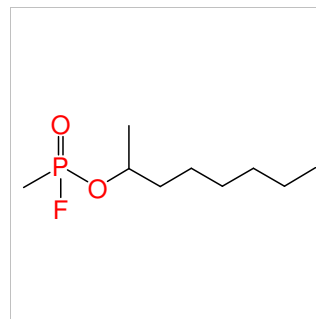

**Chemical name:** (1R)-1-Methylheptyl methylphosphonofluoridate

Schedule: 1A01

CAS RN: 24753-12-6

HS code: 2931.39

Key: 24753-12-6

Molecular formula: C<sub>9</sub>H<sub>20</sub>FO<sub>2</sub>P

CAS Index Name: Phosphonofluoridic acid, methyl-, 1-methylheptyl ester, [S-(R\*,R\*)]-

**IUPAC name:** (1R)-1-Methylheptyl methylphosphonofluoridate

Synonyms: Phosphonofluoridic acid, methyl-, 1-methylheptyl ester, (S,S)-

2-Octanol, methylphosphonofluoridate, (S,S)-

[S-(R\*,R\*)] 1-Methylheptyl methylphosphonofluoridate

(2R)-Oct-2-yl methylphosphonofluoridate

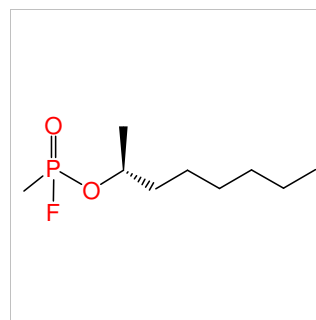

**Chemical name:** Cyclohexyl propylphosphonofluoridate

Schedule: 1A01

CAS RN: 28364-21-8

HS code: 2931.39

Key: 28364-21-8

Molecular formula: C<sub>9</sub>H<sub>18</sub>FO<sub>2</sub>P

CAS Index Name: Phosphonofluoridic acid, propyl-, cyclohexyl ester

**IUPAC name:** Cyclohexyl propylphosphonofluoridoate

Synonyms: O-Cyclohexyl propylphosphonofluoridate

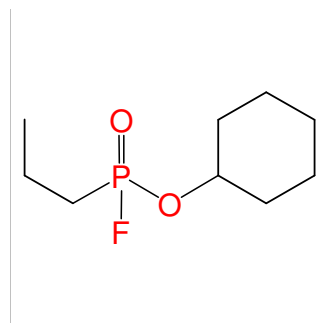

**Chemical name:** Propyl ethylphosphonofluoridate

Schedule: 1A01

CAS RN: 2992-95-2

HS code: 2931.39

Key: 2992-95-2

Molecular formula: C<sub>5</sub>H<sub>12</sub>FO<sub>2</sub>P

CAS Index Name: Phosphonofluoridic acid, ethyl-, propyl ester

**IUPAC name:** Propyl ethylphosphonofluoridoate

Synonyms: O-Propyl ethylphosphonofluoridate

n-Propyl ethylphosphonofluoridate

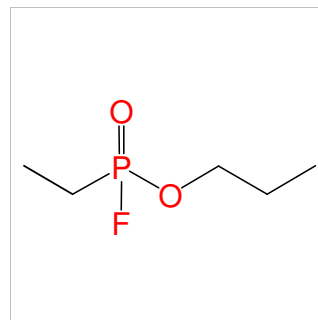

**Chemical name:** 1,3,3-Trimethylbutyl methylphosphonofluoridate

Schedule: 1A01

CAS RN: 30593-65-8

HS code: 2931.39

Key: 30593-65-8

Molecular formula: C<sub>8</sub>H<sub>18</sub>FO<sub>2</sub>P

CAS Index Name: Phosphonofluoridic acid, methyl-, 1,3,3-trimethylbutyl ester

**IUPAC name:** 1,3,3-Trimethylbutyl methylphosphonofluoridoate

Synonyms: O-1,3,3-Trimethylbutyl methylphosphonofluoridate

4,4-Dimethylpentan-2-yl methylphosphonofluoridoate

4,4-Dimethylpentan-2-yl methylphosphonofluoridate

4,4-Dimethylpent-2-yl methylphosphonofluoridate

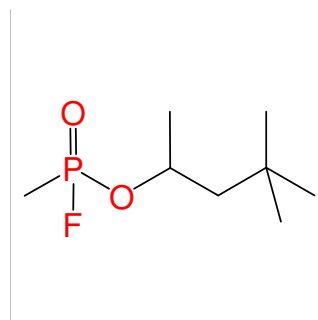

**Chemical name:** Cyclohexyl methylphosphonofluoridate

Schedule: 1A01

CAS RN: 329-99-7

HS code: 2931.39

Key: 329-99-7

Molecular formula: C<sub>7</sub>H<sub>14</sub>FO<sub>2</sub>P

CAS Index Name: Phosphonofluoridic acid, methyl-, cyclohexyl ester

**IUPAC name:** Cyclohexyl methylphosphonofluoridoate

Synonyms: O-Cyclohexyl methylphosphonofluoridate

Methyl cyclohexylfluorophosphonate

GF (chemical warfare agent)

GF

Cyclosarin

CMPF

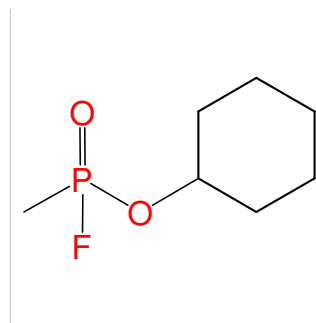

**Chemical name:** 2-Methylpentyl methylphosphonofluoridate

Schedule: 1A01

CAS RN: 333416-05-0

HS code: 2931.39

Key: 333416-05-0

Molecular formula: C<sub>7</sub>H<sub>16</sub>FO<sub>2</sub>P

CAS Index Name: Phosphonofluoridic acid, methyl-, 2-methylpentyl ester

**IUPAC name:** 2-Methylpentyl methylphosphonofluoridoate

Synonyms: O-2-Methylpentyl methylphosphonofluoridate

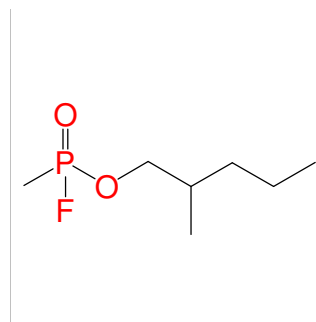

**Chemical name:** 2,4,4-Trimethylpentyl methylphosphonofluoridate

Schedule: 1A01

CAS RN: 333416-06-1

HS code: 2931.39

Key: 333416-06-1

Molecular formula: C<sub>9</sub>H<sub>20</sub>FO<sub>2</sub>P

CAS Index Name: Phosphonofluoridic acid, methyl-, 2,4,4-trimethylpentyl ester

**IUPAC name:** 2,4,4-Trimethylpentyl methylphosphonofluoridoate

Synonyms: O-2,4,4-Trimethylpentyl methylphosphonofluoridate

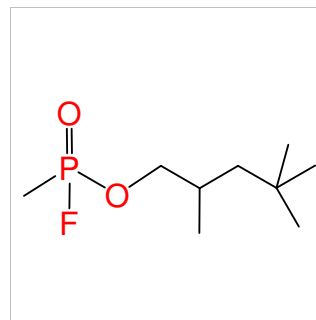



**Chemical name:** Octyl ethylphosphonofluoridate

Schedule: 1A01

CAS RN: 333416-07-2

HS code: 2931.39

Key: 333416-07-2

Molecular formula: C<sub>10</sub>H<sub>22</sub>FO<sub>2</sub>P

CAS Index Name: Phosphonofluoridic acid, ethyl-, octyl ester

**IUPAC name:** Octyl ethylphosphonofluoridoate

Synonyms: O-Octyl ethylphosphonofluoridate

n-Octyl ethylphosphonofluoridate

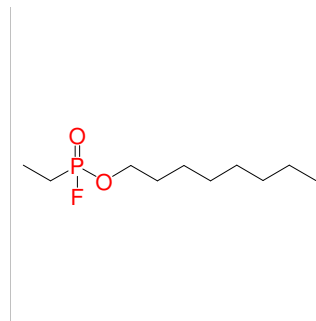

**Chemical name:** Decyl ethylphosphonofluoridate

Schedule: 1A01

CAS RN: 333416-08-3

HS code: 2931.39

Key: 333416-08-3

Molecular formula: C<sub>12</sub>H<sub>26</sub>FO<sub>2</sub>P

CAS Index Name: Phosphonofluoridic acid, ethyl-, decyl ester

**IUPAC name:** Decyl ethylphosphonofluoridoate

Synonyms: O-Decyl ethylphosphonofluoridate

n-Decyl ethylphosphonofluoridate

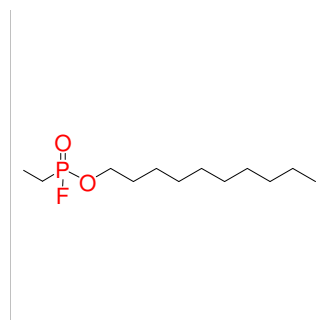

**Chemical name:** 1-Methylbutyl ethylphosphonofluoridate

Schedule: 1A01

CAS RN: 333416-09-4

HS code: 2931.39

Key: 333416-09-4

Molecular formula: C<sub>7</sub>H<sub>16</sub>FO<sub>2</sub>P

CAS Index Name: Phosphonofluoridic acid, ethyl-, 1-methylbutyl ester

**IUPAC name:** 1-Methylbutyl ethylphosphonofluoridoate

Synonyms: Pentan-2-yl ethylphosphonofluoridate

Pent-2-yl ethylphosphonofluoridate

O-1-Methylbutyl ethylphosphonofluoridate

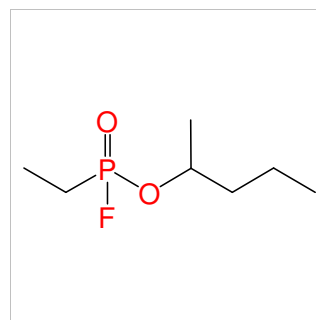

**Chemical name:** 1-Methylhexyl ethylphosphonofluoridate

Schedule: 1A01

CAS RN: 333416-10-7

HS code: 2931.39

Key: 333416-10-7

Molecular formula: C<sub>9</sub>H<sub>20</sub>FO<sub>2</sub>P

CAS Index Name: Phosphonofluoridic acid, ethyl-, 1-methylhexyl ester

**IUPAC name:** 1-Methylhexyl ethylphosphonofluoridoate

Synonyms: Phosphonofluoridic acid, ethyl-, hept-2-yl ester

O-1-Methylhexyl ethylphosphonofluoridate

Heptan-2-yl ethylphosphonofluoridate

Hept-2-yl ethylphosphonofluoridate

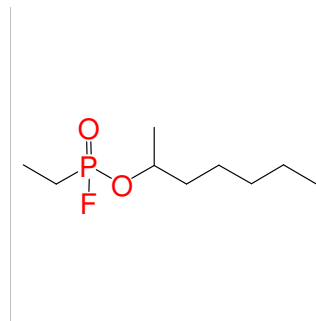

**Chemical name:** 1-Methyloctyl ethylphosphonofluoridate

Schedule: 1A01

CAS RN: 333416-11-8

HS code: 2931.39

Key: 333416-11-8

Molecular formula: C<sub>11</sub>H<sub>24</sub>FO<sub>2</sub>P

CAS Index Name: Phosphonofluoridic acid, ethyl-, 1-methyloctyl ester

**IUPAC name:** 1-Methyloctyl ethylphosphonofluoridoate

Synonyms: Phosphonofluoridic acid, ethyl-, non-2-yl ester

O-1-Methyloctyl ethylphosphonofluoridate

Nonan-2-yl ethylphosphonofluoridate

Non-2-yl ethylphosphonofluoridate

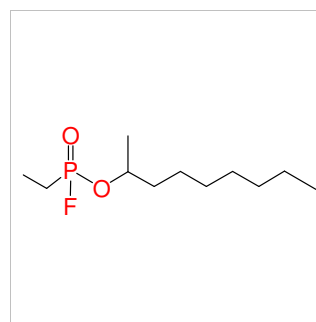

**Chemical name:** 2-Methylpentyl ethylphosphonofluoridate

Schedule: 1A01

CAS RN: 333416-12-9

HS code: 2931.39

Key: 333416-12-9

Molecular formula: C<sub>8</sub>H<sub>18</sub>FO<sub>2</sub>P

CAS Index Name: Phosphonofluoridic acid, ethyl-, 2-methylpentyl ester

**IUPAC name:** 2-Methylpentyl ethylphosphonofluoridoate

Synonyms: O-2-Methylpentyl ethylphosphonofluoridate

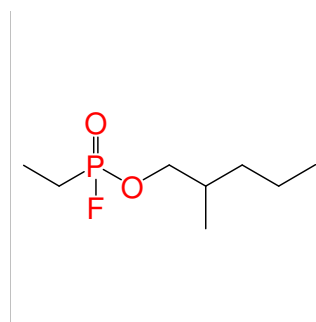

**Chemical name:** 2,4,4-Trimethylpentyl ethylphosphonofluoridate

Schedule: 1A01

CAS RN: 333416-13-0

HS code: 2931.39

Key: 333416-13-0

Molecular formula: C<sub>10</sub>H<sub>22</sub>FO<sub>2</sub>P

CAS Index Name: Phosphonofluoridic acid, ethyl-, 2,4,4-trimethylpentyl ester

**IUPAC name:** 2,4,4-Trimethylpentyl ethylphosphonofluoridoate

Synonyms: O-2,4,4-Trimethylpentyl ethylphosphonofluoridate

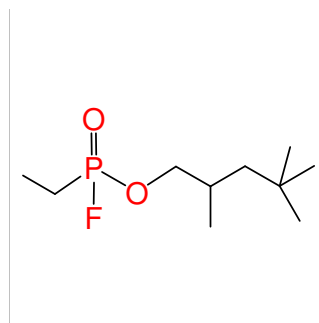

**Chemical name:** Methyl propylphosphonofluoridate

Schedule: 1A01

CAS RN: 333416-14-1

HS code: 2931.39

Key: 333416-14-1

Molecular formula: C<sub>4</sub>H<sub>10</sub>FO<sub>2</sub>P

CAS Index Name: Phosphonofluoridic acid, propyl-, methyl ester

**IUPAC name:** Methyl propylphosphonofluoridoate

Synonyms: O-Methyl propylphosphonofluoridate

O-Methyl n-propylphosphonofluoridate

Methyl n-propylphosphonofluoridate

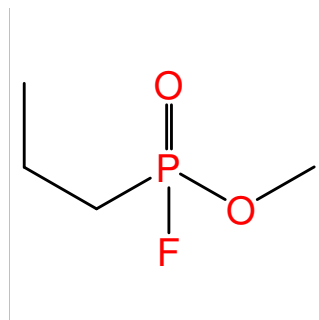

**Chemical name:** Ethyl propylphosphonofluoridate

Schedule: 1A01

CAS RN: 333416-15-2

HS code: 2931.39

Key: 333416-15-2

Molecular formula: C<sub>5</sub>H<sub>12</sub>FO<sub>2</sub>P

CAS Index Name: Phosphonofluoridic acid, propyl-, ethyl ester

**IUPAC name:** Ethyl propylphosphonofluoridoate

Synonyms: O-Ethyl propylphosphonofluoridate

O-Ethyl n-propylphosphonofluoridate

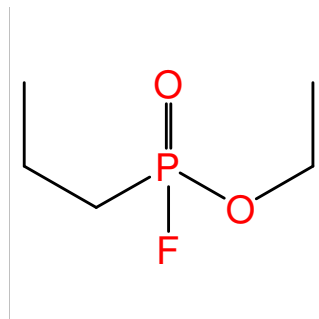

**Chemical name:** Butyl propylphosphonofluoridate

Schedule: 1A01

CAS RN: 333416-16-3

HS code: 2931.39

Key: 333416-16-3

Molecular formula: C<sub>7</sub>H<sub>16</sub>FO<sub>2</sub>P

CAS Index Name: Phosphonofluoridic acid, propyl-, butyl ester

**IUPAC name:** Butyl propylphosphonofluoridoate

Synonyms: O-Butyl propylphosphonofluoridate

n-Butyl propylphosphonofluoridate

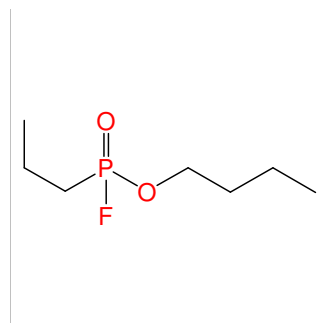

**Chemical name:** Pentyl propylphosphonofluoridate

Schedule: 1A01

CAS RN: 333416-17-4

HS code: 2931.39

Key: 333416-17-4

Molecular formula: C<sub>8</sub>H<sub>18</sub>FO<sub>2</sub>P

CAS Index Name: Phosphonofluoridic acid, propyl-, pentyl ester

**IUPAC name:** Pentyl propylphosphonofluoridoate

Synonyms: O-Pentyl propylphosphonofluoridate

n-Pentyl propylphosphonofluoridate

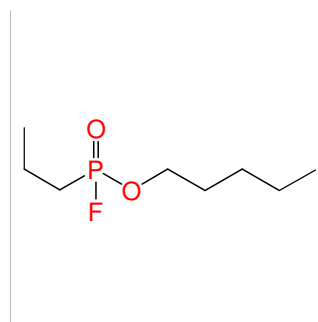

**Chemical name:** Hexyl propylphosphonofluoridate

Schedule: 1A01

CAS RN: 333416-18-5

HS code: 2931.39

Key: 333416-18-5

Molecular formula: C<sub>9</sub>H<sub>20</sub>FO<sub>2</sub>P

CAS Index Name: Phosphonofluoridic acid, propyl-, hexyl ester

**IUPAC name:** Hexyl propylphosphonofluoridoate

Synonyms: O-n-Hexyl propylphosphonofluoridate

O-Hexyl propylphosphonofluoridate

n-Hexyl propylphosphonofluoridate

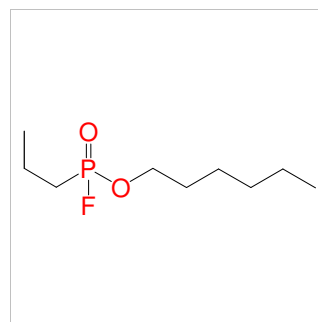

**Chemical name:** Heptyl propylphosphonofluoridate

Schedule: 1A01

CAS RN: 333416-19-6

HS code: 2931.39

Key: 333416-19-6

Molecular formula: C<sub>10</sub>H<sub>22</sub>FO<sub>2</sub>P

CAS Index Name: Phosphonofluoridic acid, propyl-, heptyl ester

**IUPAC name:** Heptyl propylphosphonofluoridoate

Synonyms: O-Heptyl propylphosphonofluoridate

n-Heptyl propylphosphonofluoridate

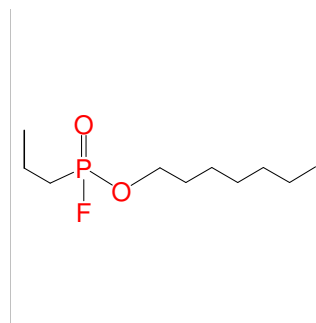

**Chemical name:** Octyl propylphosphonofluoridate

Schedule: 1A01

CAS RN: 333416-20-9

HS code: 2931.39

Key: 333416-20-9

Molecular formula: C<sub>11</sub>H<sub>24</sub>FO<sub>2</sub>P

CAS Index Name: Phosphonofluoridic acid, propyl-, octyl ester

**IUPAC name:** Octyl propylphosphonofluoridoate

Synonyms: O-Octyl propylphosphonofluoridate

n-Octyl propylphosphonofluoridate

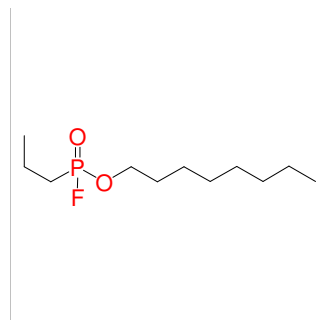

**Chemical name:** Nonyl propylphosphonofluoridate

Schedule: 1A01

CAS RN: 333416-21-0

HS code: 2931.39

Key: 333416-21-0

Molecular formula: C<sub>12</sub>H<sub>26</sub>FO<sub>2</sub>P

CAS Index Name: Phosphonofluoridic acid, propyl-, nonyl ester

**IUPAC name:** Nonyl propylphosphonofluoridoate

Synonyms: O-Nonyl propylphosphonofluoridate

n-Nonyl propylphosphonofluoridate

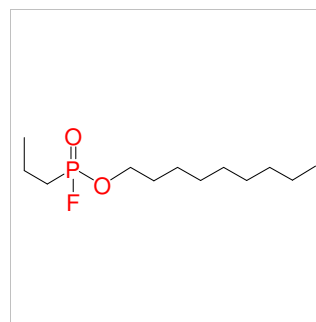

**Chemical name:** Decyl propylphosphonofluoridate

Schedule: 1A01

CAS RN: 333416-22-1

HS code: 2931.39

Key: 333416-22-1

Molecular formula: C<sub>13</sub>H<sub>28</sub>FO<sub>2</sub>P

CAS Index Name: Phosphonofluoridic acid, propyl-, decyl ester

**IUPAC name:** Decyl propylphosphonofluoridoate

Synonyms: O-Decyl propylphosphonofluoridate

n-Decyl propylphosphonofluoridate

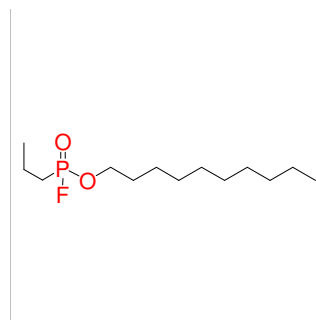

**Chemical name:** 1-Methylbutyl propylphosphonofluoridate

Schedule: 1A01

CAS RN: 333416-23-2

HS code: 2931.39

Key: 333416-23-2

Molecular formula: C<sub>8</sub>H<sub>18</sub>FO<sub>2</sub>P

CAS Index Name: Phosphonofluoridic acid, propyl-, 1-methylbutyl ester

**IUPAC name:** 1-Methylbutyl propylphosphonofluoridoate

Synonyms: Pentan-2-yl propylphosphonofluoridate

Pent-2-yl propylphosphonofluoridate

O-1-Methylbutyl propylphosphonofluoridate

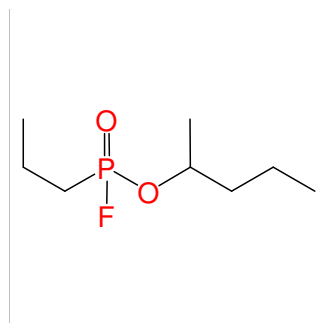

**Chemical name:** 1-Methylhexyl propylphosphonofluoridate

Schedule: 1A01

CAS RN: 333416-24-3

HS code: 2931.39

Key: 333416-24-3

Molecular formula: C<sub>10</sub>H<sub>22</sub>FO<sub>2</sub>P

CAS Index Name: Phosphonofluoridic acid, propyl-, 1-methylhexyl ester

**IUPAC name:** Heptan-2-yl propylphosphonofluoridoate

Synonyms:

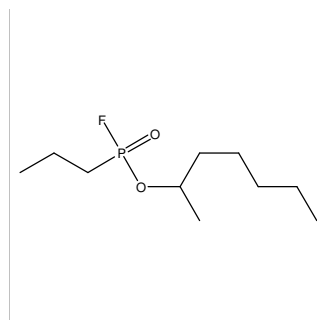

**Chemical name:** 1-Methyloctyl propylphosphonofluoridate

Schedule: 1A01

CAS RN: 333416-25-4

HS code: 2931.39

Key: 333416-25-4

Molecular formula: C<sub>12</sub>H<sub>26</sub>FO<sub>2</sub>P

CAS Index Name: Phosphonofluoridic acid, propyl-, 1-methyloctyl ester

**IUPAC name:** 1-Methyloctyl propylphosphonofluoridoate

Synonyms: Phosphonofluoridic acid, propyl-, non-2-yl ester

O-1-Methyloctyl propylphosphonofluoridate

Nonan-2-yl propylphosphonofluoridate

Non-2-yl propylphosphonofluoridate

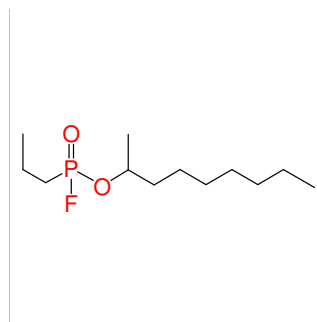

**Chemical name:** Isobutyl propylphosphonofluoridate

Schedule: 1A01

CAS RN: 333416-26-5

HS code: 2931.39

Key: 333416-26-5

Molecular formula: C<sub>7</sub>H<sub>16</sub>FO<sub>2</sub>P

CAS Index Name: Phosphonofluoridic acid, propyl-, 2-methylpropyl ester

**IUPAC name:** Isobutyl propylphosphonofluoridoate

Synonyms: O-Isobutyl propylphosphonofluoridate

2-Methylpropyl propylphosphonofluoridate

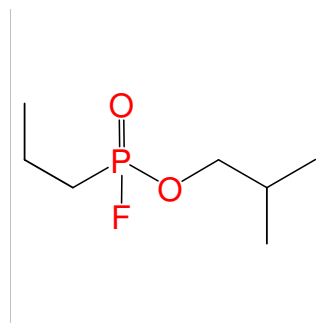

**Chemical name:** 2-Methylpentyl propylphosphonofluoridate

Schedule: 1A01

CAS RN: 333416-27-6

HS code: 2931.39

Key: 333416-27-6

Molecular formula: C<sub>9</sub>H<sub>20</sub>FO<sub>2</sub>P

CAS Index Name: Phosphonofluoridic acid, propyl-, 2-methylpentyl ester

**IUPAC name:** 2-Methylpentyl propylphosphonofluoridoate

Synonyms: O-2-Methylpentyl propylphosphonofluoridate

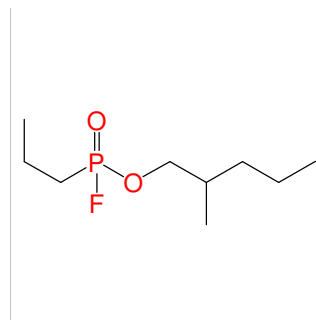

**Chemical name:** 2,4,4-Trimethylpentyl propylphosphonofluoridate

Schedule: 1A01

CAS RN: 333416-28-7

HS code: 2931.39

Key: 333416-28-7

Molecular formula: C<sub>11</sub>H<sub>24</sub>FO<sub>2</sub>P

CAS Index Name: Phosphonofluoridic acid, propyl-, 2,4,4-trimethylpentyl ester

**IUPAC name:** 2,4,4-Trimethylpentyl propylphosphonofluoridoate

Synonyms: O-2,4,4-Trimethylpentyl propylphosphonofluoridate

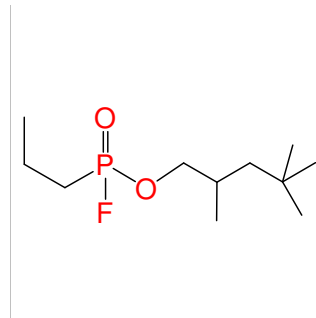

**Chemical name:** Propyl isopropylphosphonofluoridate

Schedule: 1A01

CAS RN: 333416-29-8

HS code: 2931.39

Key: 333416-29-8

Molecular formula: C<sub>6</sub>H<sub>14</sub>FO<sub>2</sub>P

CAS Index Name: Phosphonofluoridic acid, 1-methylethyl-, propyl ester

**IUPAC name:** Propyl isopropylphosphonofluoridoate

Synonyms: O-Propyl isopropylphosphonofluoridate

O-n-propyl isopropylphosphonofluoridate

n-Propyl isopropylphosphonofluoridate

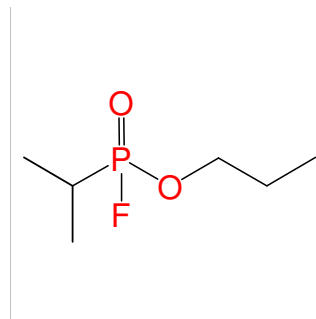

**Chemical name:** Butyl isopropylphosphonofluoridate

Schedule: 1A01

CAS RN: 333416-30-1

HS code: 2931.39

Key: 333416-30-1

Molecular formula: C<sub>7</sub>H<sub>16</sub>FO<sub>2</sub>P

CAS Index Name: Phosphonofluoridic acid, 1-methylethyl-, butyl ester

**IUPAC name:** Butyl isopropylphosphonofluoridoate

Synonyms: O-n-Butyl isopropylphosphonofluoridate

O-Butyl isopropylphosphonofluoridate

n-Butyl isopropylphosphonofluoridate

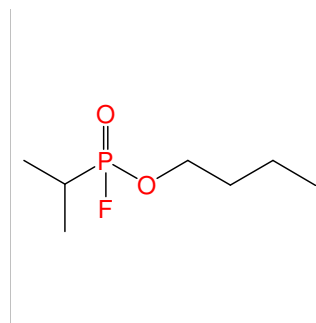

**Chemical name:** Pentyl isopropylphosphonofluoridate

Schedule: 1A01

CAS RN: 333416-31-2

HS code: 2931.39

Key: 333416-31-2

Molecular formula: C<sub>8</sub>H<sub>18</sub>FO<sub>2</sub>P

CAS Index Name: Phosphonofluoridic acid, 1-methylethyl-, pentyl ester

**IUPAC name:** Pentyl isopropylphosphonofluoridoate

Synonyms: O-Pentyl isopropylphosphonofluoridate

O-n-Pentyl isopropylphosphonofluoridate

n-Pentyl isopropylphosphonofluoridate

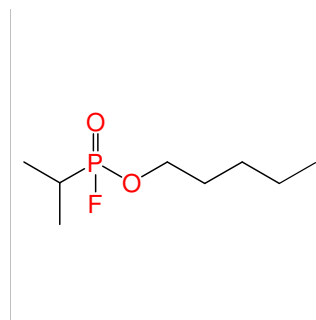

**Chemical name:** Hexyl isopropylphosphonofluoridate

Schedule: 1A01

CAS RN: 333416-32-3

HS code: 2931.39

Key: 333416-32-3

Molecular formula: C<sub>9</sub>H<sub>20</sub>FO<sub>2</sub>P

CAS Index Name: Phosphonofluoridic acid, 1-methylethyl-, hexyl ester

**IUPAC name:** Hexyl isopropylphosphonofluoridoate

Synonyms: O-Hexyl isopropylphosphonofluoridate

n-Hexyl isopropylphosphonofluoridate

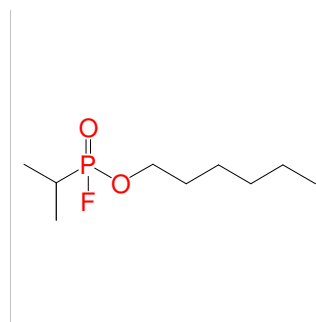



**Chemical name:** Heptyl isopropylphosphonofluoridate

Schedule: 1A01

CAS RN: 333416-33-4

HS code: 2931.39

Key: 333416-33-4

Molecular formula: C<sub>10</sub>H<sub>22</sub>FO<sub>2</sub>P

CAS Index Name: Phosphonofluoridic acid, 1-methylethyl-, heptyl ester

**IUPAC name:** Heptyl isopropylphosphonofluoridoate

Synonyms: O-Heptyl isopropylphosphonofluoridate

n-Heptyl isopropylphosphonofluoridate

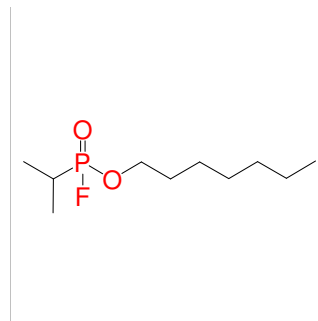

**Chemical name:** Octyl isopropylphosphonofluoridate

Schedule: 1A01

CAS RN: 333416-34-5

HS code: 2931.39

Key: 333416-34-5

Molecular formula: C<sub>11</sub>H<sub>24</sub>FO<sub>2</sub>P

CAS Index Name: Phosphonofluoridic acid, 1-methylethyl-, octyl ester

**IUPAC name:** Octyl isopropylphosphonofluoridoate

Synonyms: O-Octyl isopropylphosphonofluoridate

n-Octyl isopropylphosphonofluoridate

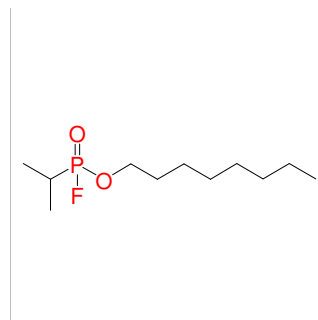

**Chemical name:** Nonyl isopropylphosphonofluoridate

Schedule: 1A01

CAS RN: 333416-35-6

HS code: 2931.39

Key: 333416-35-6

Molecular formula: C<sub>12</sub>H<sub>26</sub>FO<sub>2</sub>P

CAS Index Name: Phosphonofluoridic acid, 1-methylethyl-, nonyl ester

**IUPAC name:** Nonyl isopropylphosphonofluoridoate

Synonyms: O-Nonyl isopropylphosphonofluoridate

n-Nonyl isopropylphosphonofluoridate

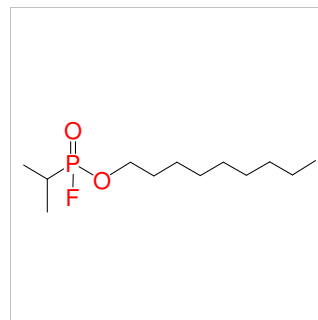

**Chemical name:** Decyl isopropylphosphonofluoridate

Schedule: 1A01

CAS RN: 333416-36-7

HS code: 2931.39

Key: 333416-36-7

Molecular formula: C<sub>13</sub>H<sub>28</sub>FO<sub>2</sub>P

CAS Index Name: Phosphonofluoridic acid, 1-methylethyl-, decyl ester

**IUPAC name:** Decyl isopropylphosphonofluoridoate

Synonyms: O-Decyl isopropylphosphonofluoridate

n-Decyl isopropylphosphonofluoridate

Decyl 1-methylethylphosphonofluoridate

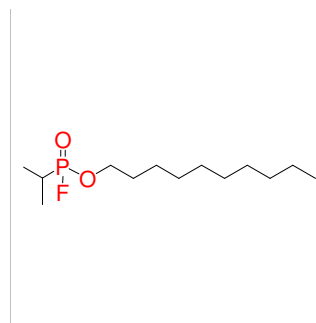

**Chemical name:** 1-Methylbutyl isopropylphosphonofluoridate

Schedule: 1A01

CAS RN: 333416-37-8

HS code: 2931.39

Key: 333416-37-8

Molecular formula: C<sub>8</sub>H<sub>18</sub>FO<sub>2</sub>P

CAS Index Name: Phosphonofluoridic acid, 1-methylethyl-, 1-methylbutyl ester

**IUPAC name:** 1-Methylbutyl isopropylphosphonofluoridoate

Synonyms: Pentan-2-yl isopropylphosphonofluoridate

Pent-2-yl isopropylphosphonofluoridate

O-1-Methylbutyl isopropylphosphonofluoridate

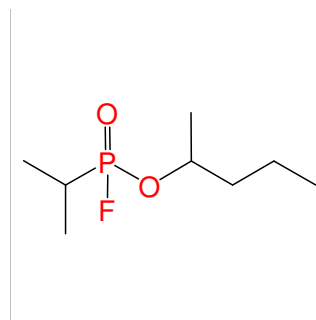

**Chemical name:** 1-Methylhexyl isopropylphosphonofluoridate

Schedule: 1A01

CAS RN: 333416-38-9

HS code: 2931.39

Key: 333416-38-9

Molecular formula: C<sub>10</sub>H<sub>22</sub>FO<sub>2</sub>P

CAS Index Name: Phosphonofluoridic acid, 1-methylethyl-, 1-methylhexyl ester

**IUPAC name:** 1-Methylhexyl isopropylphosphonofluoridoate

Synonyms: Phosphonofluoridic acid, 1-methylethyl-, hept-2-yl ester

O-1-Methylhexyl isopropylphosphonofluoridate

Heptan-2-yl isopropylphosphonofluoridate

Hept-2-yl isopropylphosphonofluoridate

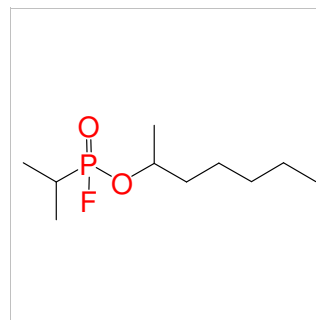

**Chemical name:** 1-Methyloctyl isopropylphosphonofluoridate

Schedule: 1A01

CAS RN: 333416-39-0

HS code: 2931.39

Key: 333416-39-0

Molecular formula: C<sub>12</sub>H<sub>26</sub>FO<sub>2</sub>P

CAS Index Name: Phosphonofluoridic acid, 1-methylethyl-, 1-methyloctyl ester

**IUPAC name:** 1-Methyloctyl isopropylphosphonofluoridoate

Synonyms: Phosphonofluoridic acid, 1-methylethyl-, non-2-yl ester

O-1-Methyloctyl isopropylphosphonofluoridate

Nonan-2-yl isopropylphosphonofluoridate

Non-2-yl isopropylphosphonofluoridate

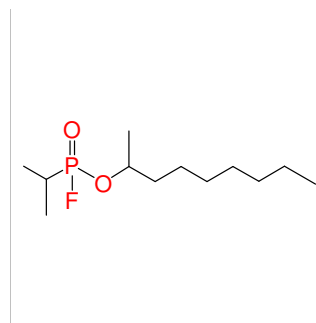

**Chemical name:** Isobutyl isopropylphosphonofluoridate

Schedule: 1A01

CAS RN: 333416-40-3

HS code: 2931.39

Key: 333416-40-3

Molecular formula: C<sub>7</sub>H<sub>16</sub>FO<sub>2</sub>P

CAS Index Name: Phosphonofluoridic acid, 1-methylethyl-, 2-methylpropyl ester

**IUPAC name:** Isobutyl isopropylphosphonofluoridoate

Synonyms: O-Isobutyl isopropylphosphonofluoridate

2-Methylpropyl isopropylphosphonofluoridate

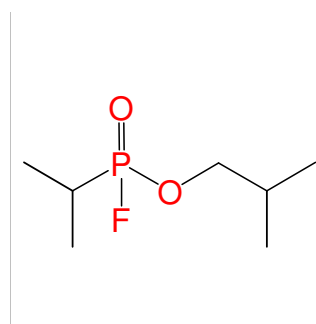

**Chemical name:** 2-Methylpentyl isopropylphosphonofluoridate

Schedule: 1A01

CAS RN: 333416-41-4

HS code: 2931.39

Key: 333416-41-4

Molecular formula: C<sub>9</sub>H<sub>20</sub>FO<sub>2</sub>P

CAS Index Name: Phosphonofluoridic acid, 1-methylethyl-, 2-methylpentyl ester

**IUPAC name:** 2-Methylpentyl isopropylphosphonofluoridoate

Synonyms: O-2-Methylpentyl isopropylphosphonofluoridate

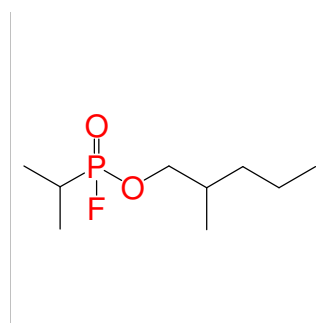

**Chemical name:** 2,4,4-Trimethylpentyl isopropylphosphonofluoridate

Schedule: 1A01

CAS RN: 333416-43-6

HS code: 2931.39

Key: 333416-43-6

Molecular formula: C<sub>11</sub>H<sub>24</sub>FO<sub>2</sub>P

CAS Index Name: Phosphonofluoridic acid, 1-methylethyl-, 2,4,4-trimethylpentyl ester

**IUPAC name:** 2,4,4-Trimethylpentyl isopropylphosphonofluoridoate

Synonyms: O-2,4,4-Trimethylpentyl isopropylphosphonofluoridate

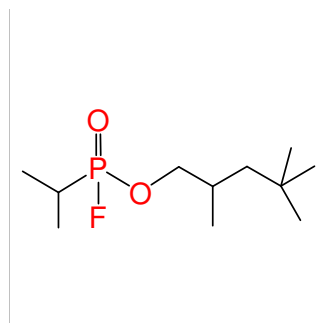

**Chemical name:** Cyclohexyl isopropylphosphonofluoridate

Schedule: 1A01

CAS RN: 333416-55-0

HS code: 2931.39

Key: 333416-55-0

Molecular formula: C<sub>9</sub>H<sub>18</sub>FO<sub>2</sub>P

CAS Index Name: Phosphonofluoridic acid, 1-methylethyl-, cyclohexyl ester

**IUPAC name:** Cyclohexyl isopropylphosphonofluoridoate

Synonyms: O-Cyclohexyl isopropylphosphonofluoridate

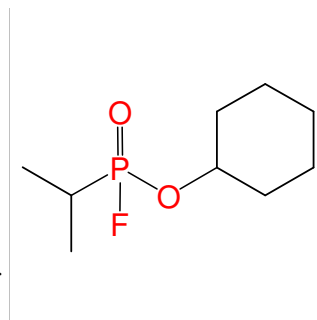

**Chemical name:** 4-Ethylcyclohexyl methylphosphonofluoridate

Schedule: 1A01

CAS RN: 333416-60-7

HS code: 2931.39

Key: 333416-60-7

Molecular formula: C<sub>9</sub>H<sub>18</sub>FO<sub>2</sub>P

CAS Index Name: Phosphonofluoridic acid, methyl-, 4-ethylcyclohexyl ester

**IUPAC name:** 4-Ethylcyclohexyl methylphosphonofluoridoate

Synonyms: O-4-Ethylcyclohexyl methylphosphonofluoridate

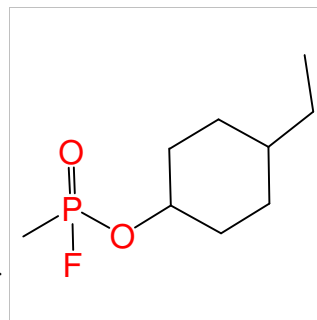

**Chemical name:** 3,3,5,5-Tetramethylcyclohexyl methylphosphonofluoridate

Schedule: 1A01

CAS RN: 333416-63-0

HS code: 2931.39

Key: 333416-63-0

Molecular formula: C<sub>11</sub>H<sub>22</sub>FO<sub>2</sub>P

CAS Index Name: Phosphonofluoridic acid, methyl-, 3,3,5,5-tetramethylcyclohexyl ester

**IUPAC name:** 3,3,5,5-tetramethylcyclohexyl methylphosphonofluoridoate

Synonyms:

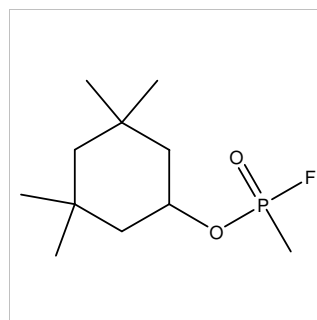

**Chemical name:** 3-Methylcyclohexyl ethylphosphonofluoridate

Schedule: 1A01

CAS RN: 333416-64-1

HS code: 2931.39

Key: 333416-64-1

Molecular formula: C<sub>9</sub>H<sub>18</sub>FO<sub>2</sub>P

CAS Index Name: Phosphonofluoridic acid, ethyl-, 3-methylcyclohexyl ester

**IUPAC name:** 3-Methylcyclohexyl ethylphosphonofluoridoate

Synonyms: O-3-Methylcyclohexyl ethylphosphonofluoridate

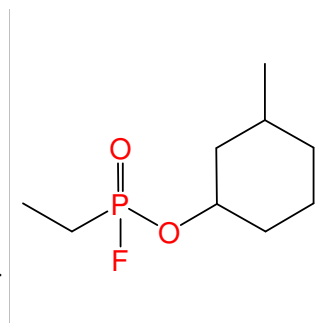

**Chemical name:** 4-Ethylcyclohexyl ethylphosphonofluoridate

Schedule: 1A01

CAS RN: 333416-65-2

HS code: 2931.39

Key: 333416-65-2

Molecular formula: C<sub>10</sub>H<sub>20</sub>FO<sub>2</sub>P

CAS Index Name: Phosphonofluoridic acid, ethyl-, 4-ethylcyclohexyl ester

**IUPAC name:** 4-Ethylcyclohexyl ethylphosphonofluoridoate

Synonyms: O-4-Ethylcyclohexyl ethylphosphonofluoridate

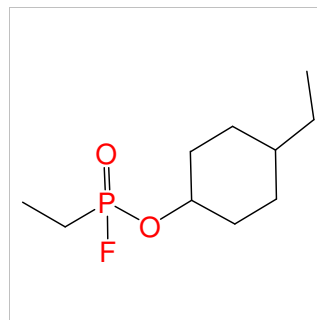

**Chemical name:** 3,3,5,5-Tetramethylcyclohexyl ethylphosphonofluoridate

Schedule: 1A01

CAS RN: 333416-68-5

HS code: 2931.39

Key: 333416-68-5

Molecular formula: C<sub>12</sub>H<sub>24</sub>FO<sub>2</sub>P

CAS Index Name: Phosphonofluoridic acid, ethyl-, 3,3,5,5-tetramethylcyclohexyl ester

**IUPAC name:** 3,3,5,5-tetramethylcyclohexyl ethylphosphonofluoridoate

Synonyms:

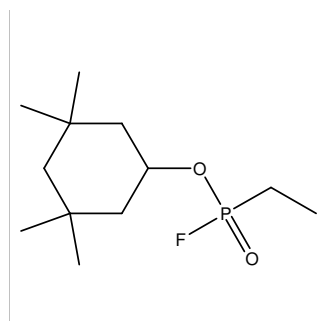

**Chemical name:** 3-Methylcyclohexyl propylphosphonofluoridate

Schedule: 1A01

CAS RN: 333416-69-6

HS code: 2931.39

Key: 333416-69-6

Molecular formula: C<sub>10</sub>H<sub>20</sub>FO<sub>2</sub>P

CAS Index Name: Phosphonofluoridic acid, P-propyl-, 3-methylcyclohexyl ester

**IUPAC name:** 3-methylcyclohexyl propylphosphonofluoridoate

Synonyms:

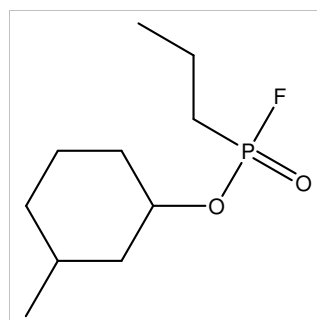

**Chemical name:** 4-Ethylcyclohexyl propylphosphonofluoridate

Schedule: 1A01

CAS RN: 333416-70-9

HS code: 2931.39

Key: 333416-70-9

Molecular formula: C<sub>11</sub>H<sub>22</sub>FO<sub>2</sub>P

CAS Index Name: Phosphonofluoridic acid, propyl-, 4-ethylcyclohexyl ester

**IUPAC name:** 4-Ethylcyclohexyl propylphosphonofluoridoate

Synonyms: O-4-Ethylcyclohexyl propylphosphonofluoridate

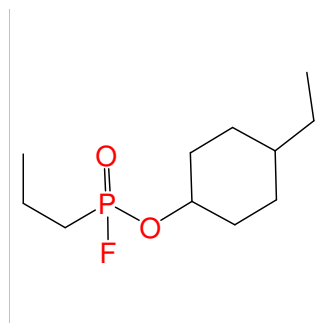

**Chemical name:** 3,3,5,5-Tetramethylcyclohexyl propylphosphonofluoridate

Schedule: 1A01

CAS RN: 333416-72-1

HS code: 2931.39

Key: 333416-72-1

Molecular formula: C<sub>13</sub>H<sub>26</sub>FO<sub>2</sub>P

CAS Index Name: Phosphonofluoridic acid, propyl-, 3,3,5,5-tetramethylcyclohexyl ester

**IUPAC name:** 3,3,5,5-Tetramethylcyclohexyl propylphosphonofluoridoate

Synonyms: O-3,3,5,5-Tetramethylcyclohexyl propylphosphonofluoridate

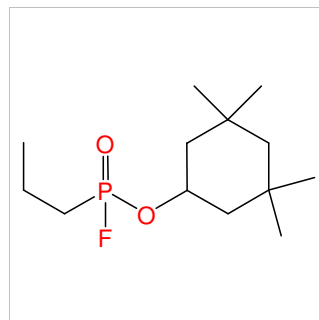

**Chemical name:** 3-Methylcyclohexyl isopropylphosphonofluoridate

Schedule: 1A01

CAS RN: 333416-73-2

HS code: 2931.39

Key: 333416-73-2

Molecular formula: C<sub>10</sub>H<sub>20</sub>FO<sub>2</sub>P

CAS Index Name: Phosphonofluoridic acid, 1-methylethyl-, 3-methylcyclohexyl ester

**IUPAC name:** 3-Methylcyclohexyl isopropylphosphonofluoridoate

Synonyms: O-3-Methylcyclohexyl isopropylphosphonofluoridate

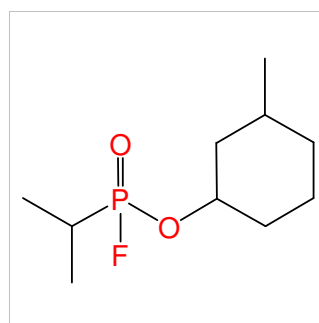

**Chemical name:** 4-Ethylcyclohexyl isopropylphosphonofluoridate

Schedule: 1A01

CAS RN: 333416-74-3

HS code: 2931.39

Key: 333416-74-3

Molecular formula: C<sub>11</sub>H<sub>22</sub>FO<sub>2</sub>P

CAS Index Name: Phosphonofluoridic acid, 1-methylethyl-, 4-ethylcyclohexyl ester

**IUPAC name:** 4-Ethylcyclohexyl isopropylphosphonofluoridoate

Synonyms: O-4-Ethylcyclohexyl isopropylphosphonofluoridate

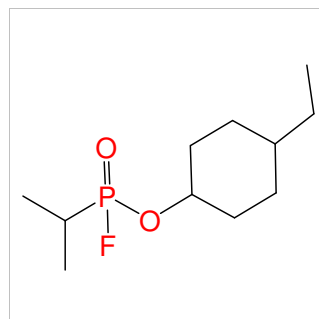

**Chemical name:** 3,3,5,5-Tetramethylcyclohexyl isopropylphosphonofluoridate

Schedule: 1A01

CAS RN: 333416-76-5

HS code: 2931.39

Key: 333416-76-5

Molecular formula: C<sub>13</sub>H<sub>26</sub>FO<sub>2</sub>P

CAS Index Name: Phosphonofluoridic acid, (1-methylethyl)-, 3,3,5,5-tetramethylcyclohexyl ester

**IUPAC name:** 3,3,5,5-Tetramethylcyclohexyl isopropylphosphonofluoridoate

Synonyms: O-3,3,5,5-Tetramethylcyclohexyl isopropylphosphonofluoridate

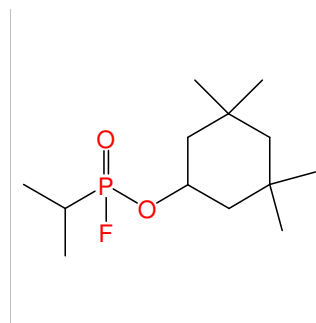

**Chemical name:** Cyclobutyl ethylphosphonofluoridate

Schedule: 1A01

CAS RN: 345239-03-4

HS code: 2931.39

Key: 345239-03-4

Molecular formula: C<sub>6</sub>H<sub>12</sub>FO<sub>2</sub>P

CAS Index Name: Phosphonofluoridic acid, ethyl-, cyclobutyl ester

**IUPAC name:** Cyclobutyl ethylphosphonofluoridoate

Synonyms:

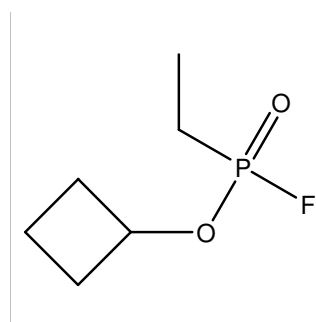

**Chemical name:** Cyclobutyl isopropylphosphonofluoridate

Schedule: 1A01

CAS RN: 345239-04-5

HS code: 2931.39

Key: 345239-04-5

Molecular formula: C<sub>7</sub>H<sub>14</sub>FO<sub>2</sub>P

CAS Index Name: Phosphonofluoridic acid, (1-methylethyl)-, cyclobutyl ester

**IUPAC name:** Cyclobutyl isopropylphosphonofluoridoate

Synonyms:

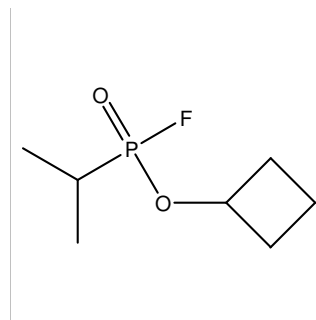

**Chemical name:** Cyclobutyl propylphosphonofluoridate

Schedule: 1A01

CAS RN: 345239-05-6

HS code: 2931.39

Key: 345239-05-6

Molecular formula: C<sub>7</sub>H<sub>14</sub>FO<sub>2</sub>P

CAS Index Name: Phosphonofluoridic acid, propyl-, cyclobutyl ester

**IUPAC name:** Cyclobutyl propylphosphonofluoridoate

Synonyms: O-Cyclobutyl propylphosphonofluoridate

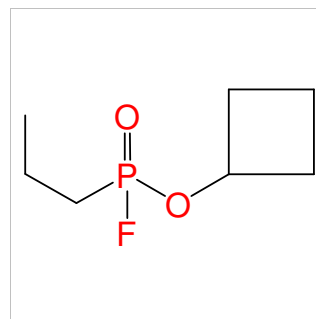

**Chemical name:** Cyclopentyl ethylphosphonofluoridate

Schedule: 1A01

CAS RN: 345239-06-7

HS code: 2931.39

Key: 345239-06-7

Molecular formula: C<sub>7</sub>H<sub>14</sub>FO<sub>2</sub>P

CAS Index Name: Phosphonofluoridic acid, ethyl-, cyclopentyl ester

**IUPAC name:** Cyclopentyl ethylphosphonofluoridoate

Synonyms: O-Cyclopentyl ethylphosphonofluoridate

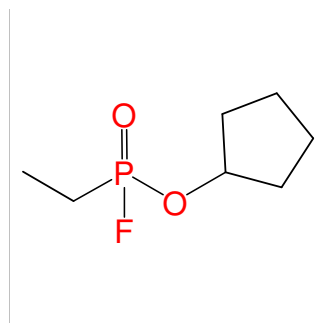

**Chemical name:** Cyclopentyl isopropylphosphonofluoridate

Schedule: 1A01

CAS RN: 345239-07-8

HS code: 2931.39

Key: 345239-07-8

Molecular formula: C<sub>8</sub>H<sub>16</sub>FO<sub>2</sub>P

CAS Index Name: Phosphonofluoridic acid, 1-methylethyl-, cyclopentyl ester

**IUPAC name:** Cyclopentyl isopropylphosphonofluoridoate

Synonyms: O-Cyclopentyl isopropylphosphonofluoridate

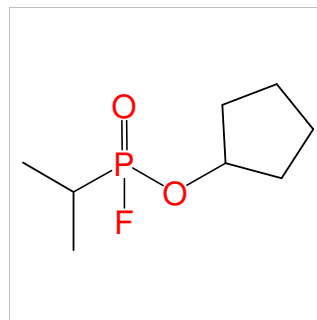

**Chemical name:** Cyclopentyl propylphosphonofluoridate

Schedule: 1A01

CAS RN: 345239-08-9

HS code: 2931.39

Key: 345239-08-9

Molecular formula: C<sub>8</sub>H<sub>16</sub>FO<sub>2</sub>P

CAS Index Name: Phosphonofluoridic acid, propyl-, cyclopentyl ester

**IUPAC name:** Cyclopentyl propylphosphonofluoridoate

Synonyms: O-Cyclopentyl propylphosphonofluoridate

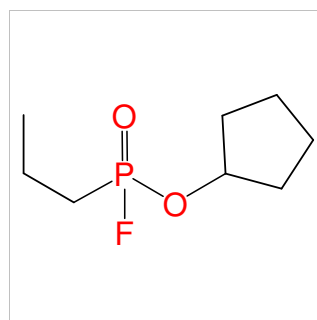

**Chemical name:** Cycloheptyl ethylphosphonofluoridate

Schedule: 1A01

CAS RN: 345239-09-0

HS code: 2931.39

Key: 345239-09-0

Molecular formula: C<sub>9</sub>H<sub>18</sub>FO<sub>2</sub>P

CAS Index Name: Phosphonofluoridic acid, ethyl-, cycloheptyl ester

**IUPAC name:** Cycloheptyl ethylphosphonofluoridoate

Synonyms: O-Cycloheptyl ethylphosphonofluoridate

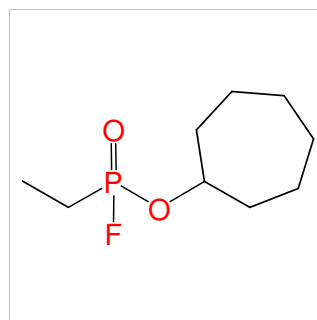



**Chemical name:** Cycloheptyl isopropylphosphonofluoridate

Schedule: 1A01

CAS RN: 345239-10-3

HS code: 2931.39

Key: 345239-10-3

Molecular formula: C<sub>10</sub>H<sub>20</sub>FO<sub>2</sub>P

CAS Index Name: Phosphonofluoridic acid, 1-methylethyl-, cycloheptyl ester

**IUPAC name:** Cycloheptyl isopropylphosphonofluoridoate

Synonyms: O-Cycloheptyl isopropylphosphonofluoridate

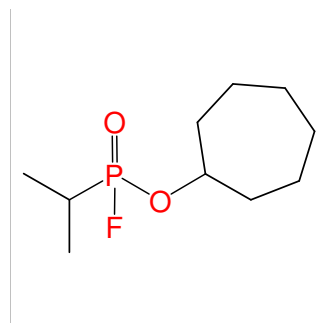

**Chemical name:** Cycloheptyl propylphosphonofluoridate

Schedule: 1A01

CAS RN: 345239-11-4

HS code: 2931.39

Key: 345239-11-4

Molecular formula: C<sub>10</sub>H<sub>20</sub>FO<sub>2</sub>P

CAS Index Name: Phosphonofluoridic acid, propyl-, cycloheptyl ester

**IUPAC name:** Cycloheptyl propylphosphonofluoridoate

Synonyms: O-Cycloheptyl propylphosphonofluoridate

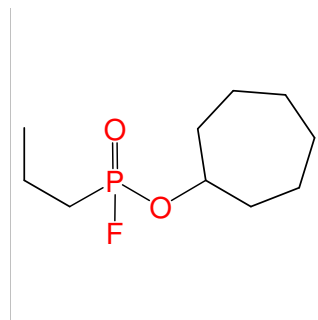

**Chemical name:** Cyclooctyl ethylphosphonofluoridate

Schedule: 1A01

CAS RN: 345239-12-5

HS code: 2931.39

Key: 345239-12-5

Molecular formula: C<sub>10</sub>H<sub>20</sub>FO<sub>2</sub>P

CAS Index Name: Phosphonofluoridic acid, ethyl-, cyclooctyl ester

**IUPAC name:** Cyclooctyl ethylphosphonofluoridoate

Synonyms: O-Cyclooctyl ethylphosphonofluoridate

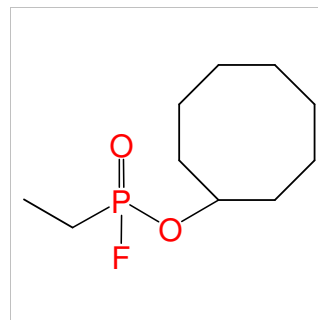

**Chemical name:** Cyclooctyl isopropylphosphonofluoridate

Schedule: 1A01

CAS RN: 345239-13-6

HS code: 2931.39

Key: 345239-13-6

Molecular formula: C<sub>11</sub>H<sub>22</sub>FO<sub>2</sub>P

CAS Index Name: Phosphonofluoridic acid, 1-methylethyl-, cyclooctyl ester

**IUPAC name:** Cyclooctyl isopropylphosphonofluoridoate

Synonyms: O-Cyclooctyl isopropylphosphonofluoridate

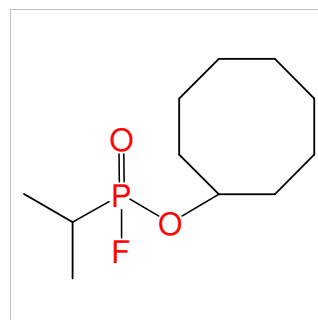

**Chemical name:** Cyclooctyl propylphosphonofluoridate

Schedule: 1A01

CAS RN: 345239-14-7

HS code: 2931.39

Key: 345239-14-7

Molecular formula: C<sub>11</sub>H<sub>22</sub>FO<sub>2</sub>P

CAS Index Name: Phosphonofluoridic acid, propyl-, cyclooctyl ester

**IUPAC name:** Cyclooctyl propylphosphonofluoridoate

Synonyms: O-Cyclooctyl propylphosphonofluoridate

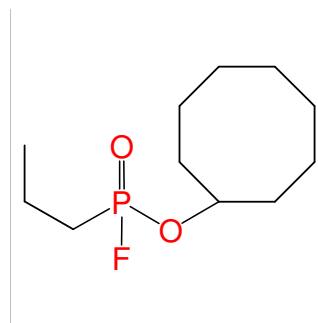

**Chemical name:** 1-Ethyl-2-methylpropyl methylphosphonofluoridate

Schedule: 1A01

CAS RN: 345260-66-4

HS code: 2931.39

Key: 345260-66-4

Molecular formula: C<sub>7</sub>H<sub>16</sub>FO<sub>2</sub>P

CAS Index Name: Phosphonofluoridic acid, methyl-, 1-ethyl-2-methylpropyl ester

**IUPAC name:** 1-Ethyl-2-methylpropyl methylphosphonofluoridoate

Synonyms: O-1-Ethyl-2-methylpropyl methylphosphonofluoridate

2-Methylpentan-3-yl methylphosphonofluoridate

2-Methylpent-3-yl methylphosphonofluoridate

1-Ethylisobutyl methylphosphonofluoridate

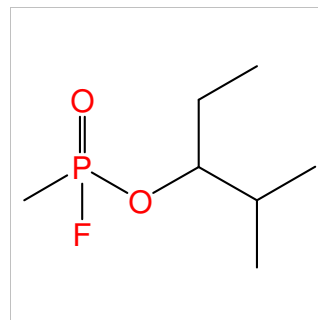

**Chemical name:** 1-Ethyl-2-methylpropyl ethylphosphonofluoridate

Schedule: 1A01

CAS RN: 345260-67-5

HS code: 2931.39

Key: 345260-67-5

Molecular formula: C<sub>8</sub>H<sub>18</sub>FO<sub>2</sub>P

CAS Index Name: Phosphonofluoridic acid, ethyl-, 1-ethyl-2-methylpropyl ester

**IUPAC name:** 1-Ethyl-2-methylpropyl ethylphosphonofluoridoate

Synonyms: O-1-Ethyl-2-methylpropyl ethylphosphonofluoridate

2-Methylpentan-3-yl ethylphosphonofluoridate

2-Methylpent-3-yl ethylphosphonofluoridate

1-Ethylisobutyl ethylphosphonofluoridate

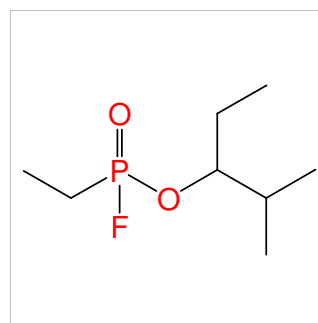

**Chemical name:** 1-Ethyl-2-methylpropyl isopropylphosphonofluoridate

Schedule: 1A01

CAS RN: 345260-68-6

HS code: 2931.39

Key: 345260-68-6

Molecular formula: C<sub>9</sub>H<sub>20</sub>FO<sub>2</sub>P

CAS Index Name: Phosphonofluoridic acid, 1-methylethyl-, 1-ethyl-2-methylpropyl ester

**IUPAC name:** 1-Ethyl-2-methylpropyl isopropylphosphonofluoridoate

Synonyms: O-1-Ethyl-2-methylpropyl isopropylphosphonofluoridate

2-Methylpentan-3-yl isopropylphosphonofluoridate

2-Methylpent-3-yl isopropylphosphonofluoridate

1-Ethylisobutyl isopropylphosphonofluoridate

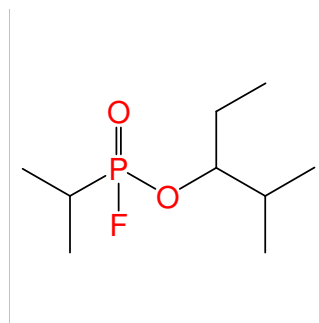

**Chemical name:** 1-Ethyl-2-methylpropyl propylphosphonofluoridate

Schedule: 1A01

CAS RN: 345260-69-7

HS code: 2931.39

Key: 345260-69-7

Molecular formula: C<sub>9</sub>H<sub>20</sub>FO<sub>2</sub>P

CAS Index Name: Phosphonofluoridic acid, propyl-, 1-ethyl-2-methylpropyl ester

**IUPAC name:** 1-Ethyl-2-methylpropyl propylphosphonofluoridoate

Synonyms: O-1-Ethyl-2-methylpropyl propylphosphonofluoridate

2-Methylpentan-3-yl propylphosphonofluoridate

2-Methylpent-3-yl propylphosphonofluoridate

1-Ethylisobutyl propylphosphonofluoridate

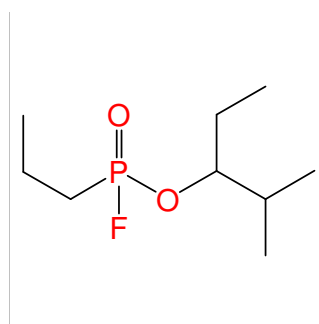

**Chemical name:** 1-Isopropylbutyl methylphosphonofluoridate

Schedule: 1A01

CAS RN: 345260-70-0

HS code: 2931.39

Key: 345260-70-0

Molecular formula: C<sub>8</sub>H<sub>18</sub>FO<sub>2</sub>P

CAS Index Name: Phosphonofluoridic acid, methyl-, 1-(1-methylethyl)butyl ester

**IUPAC name:** 1-Isopropylbutyl methylphosphonofluoridoate

Synonyms: Phosphonofluoridic acid, methyl-, 2-methylhex-3-yl ester

O-1-Isopropylbutyl methylphosphonofluoridate

2-Methylhexan-3-yl methylphosphonofluoridate

2-Methylhex-3-yl methylphosphonofluoridate

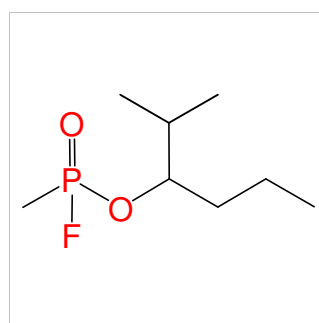

**Chemical name:** 1-Isopropylbutyl ethylphosphonofluoridate

Schedule: 1A01

CAS RN: 345260-71-1

HS code: 2931.39

Key: 345260-71-1

Molecular formula: C<sub>9</sub>H<sub>20</sub>FO<sub>2</sub>P

CAS Index Name: Phosphonofluoridic acid, ethyl-, 1-(1-methylethyl)butyl ester

**IUPAC name:** 1-Isopropylbutyl ethylphosphonofluoridoate

Synonyms: Phosphonofluoridic acid, ethyl-, 2-methylhex-3-yl ester

O-1-Isopropylbutyl ethylphosphonofluoridate

2-Methylhexan-3-yl ethylphosphonofluoridate

2-Methylhex-3-yl ethylphosphonofluoridate

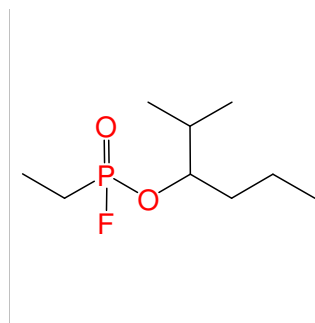

**Chemical name:** 1-Isopropylbutyl isopropylphosphonofluoridate

Schedule: 1A01

CAS RN: 345260-72-2

HS code: 2931.39

Key: 345260-72-2

Molecular formula: C<sub>10</sub>H<sub>22</sub>FO<sub>2</sub>P

CAS Index Name: Phosphonofluoridic acid, 1-methylethyl-, 1-(1-methylethyl)butyl ester

**IUPAC name:** 1-Isopropylbutyl isopropylphosphonofluoridoate

Synonyms: Phosphonofluoridic acid, 1-methylethyl-, 2-methylhex-3-yl ester

O-1-Isopropylbutyl isopropylphosphonofluoridate

2-Methylhexan-3-yl isopropylphosphonofluoridate

2-Methylhex-3-yl isopropylphosphonofluoridate

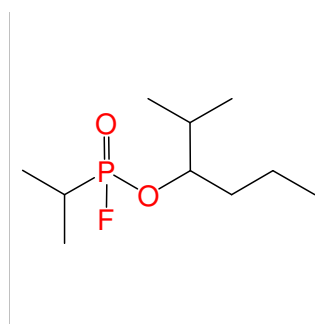

**Chemical name:** 1-Isopropylbutyl propylphosphonofluoridate

Schedule: 1A01

CAS RN: 345260-73-3

HS code: 2931.39

Key: 345260-73-3

Molecular formula: C<sub>10</sub>H<sub>22</sub>FO<sub>2</sub>P

CAS Index Name: Phosphonofluoridic acid, propyl-, 1-(1-methylethyl)butyl ester

**IUPAC name:**

Synonyms: Phosphonofluoridic acid, propyl-, 2-methylhex-3-yl ester

O-1-Isopropylbutyl propylphosphonofluoridate

2-Methylhexan-3-yl propylphosphonofluoridate

2-Methylhex-3-yl propylphosphonofluoridate

1-Isopropylbutyl propylphosphonofluoridoate

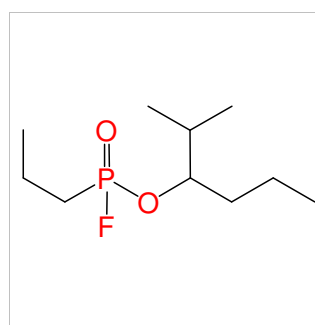

**Chemical name:** 1-Ethyl-2,2-dimethylpropyl methylphosphonofluoridate

Schedule: 1A01

CAS RN: 345260-75-5

HS code: 2931.39

Key: 345260-75-5

Molecular formula: C<sub>8</sub>H<sub>18</sub>FO<sub>2</sub>P

CAS Index Name: Phosphonofluoridic acid, methyl-, 1-ethyl-2,2-dimethylpropyl ester

**IUPAC name:** 1-Ethyl-2,2-dimethylpropyl methylphosphonofluoridoate

Synonyms: O-1-Ethyl-2,2-dimethylpropyl methylphosphonofluoridate

2,2-Dimethylpentan-3-yl methylphosphonofluoridate

2,2-Dimethylpent-3-yl methylphosphonofluoridate

1-tert-Butylpropyl methylphosphonofluoridate

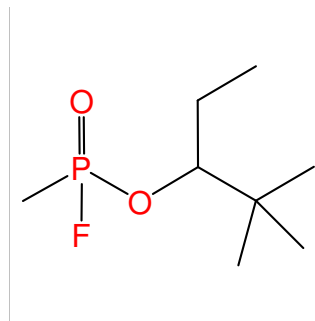

**Chemical name:** 1-Ethyl-2,2-dimethylpropyl ethylphosphonofluoridate

Schedule: 1A01

CAS RN: 345260-76-6

HS code: 2931.39

Key: 345260-76-6

Molecular formula: C<sub>9</sub>H<sub>20</sub>FO<sub>2</sub>P

CAS Index Name: Phosphonofluoridic acid, ethyl-, 1-ethyl-2,2-dimethylpropyl ester

**IUPAC name:** 1-Ethyl-2,2-dimethylpropyl ethylphosphonofluoridoate

Synonyms: O-1-Ethyl-2,2-dimethylpropyl ethylphosphonofluoridate

2,2-Dimethylpentan-3-yl ethylphosphonofluoridate

2,2-Dimethylpent-3-yl ethylphosphonofluoridate

1-tert-Butylpropyl ethylphosphonofluoridate

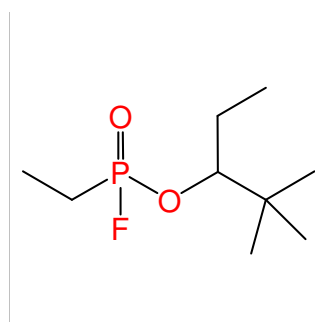

**Chemical name:** 1-Ethyl-2,2-dimethylpropyl isopropylphosphonofluoridate

Schedule: 1A01

CAS RN: 345260-77-7

HS code: 2931.39

Key: 345260-77-7

Molecular formula: C<sub>10</sub>H<sub>22</sub>FO<sub>2</sub>P

CAS Index Name: Phosphonofluoridic acid, 1-methylethyl-, 1-ethyl-2,2-dimethylpropyl ester

**IUPAC name:** 1-Ethyl-2,2-dimethylpropyl isopropylphosphonofluoridoate

Synonyms: O-1-Ethyl-2,2-dimethylpropyl isopropylphosphonofluoridate

2,2-Dimethylpentan-3-yl isopropylphosphonofluoridate

2,2-Dimethylpent-3-yl isopropylphosphonofluoridate

1-tert-Butylpropyl isopropylphosphonofluoridate

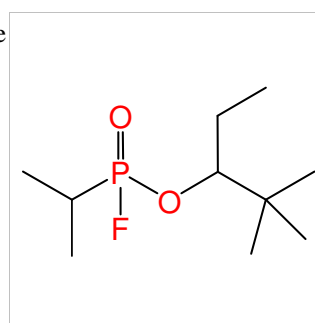

**Chemical name:** 1-Ethyl-2,2-dimethylpropyl propylphosphonofluoridate

Schedule: 1A01

CAS RN: 345260-78-8

HS code: 2931.39

Key: 345260-78-8

Molecular formula: C<sub>10</sub>H<sub>22</sub>FO<sub>2</sub>P

CAS Index Name: Phosphonofluoridic acid, propyl-, 1-ethyl-2,2-dimethylpropyl ester

**IUPAC name:** 1-Ethyl-2,2-dimethylpropyl propylphosphonofluoridoate

Synonyms: Phosphonofluoridic acid, propyl-, 2,2-dimethylpent-3-yl ester

O-1-Ethyl-2,2-dimethylpropyl propylphosphonofluoridate

2,2-Dimethylpentan-3-yl propylphosphonofluoridate

2,2-Dimethylpent-3-yl propylphosphonofluoridate

1-tert-Butylpropyl propylphosphonofluoridate

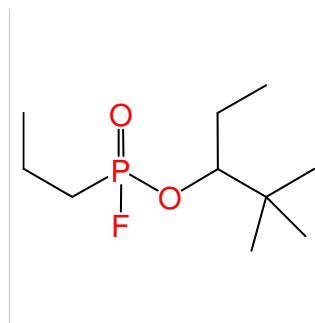

**Chemical name:** 1-Isopropyl-2-methylpropyl ethylphosphonofluoridate

Schedule: 1A01

CAS RN: 345260-79-9

HS code: 2931.39

Key: 345260-79-9

Molecular formula: C<sub>9</sub>H<sub>20</sub>FO<sub>2</sub>P

CAS Index Name: Phosphonofluoridic acid, ethyl-, 1-(1-methylethyl)-2-methylpropyl ester

**IUPAC name:** 1-Isopropyl-2-methylpropyl ethylphosphonofluoridoate

Synonyms: Phosphonofluoridic acid, ethyl-, 2,4-dimethylpent-3-yl ester

O-1-Isopropyl-2-methylpropyl ethylphosphonofluoridate

2,4-Dimethylpentan-3-yl ethylphosphonofluoridate

2,4-Dimethylpent-3-yl ethylphosphonofluoridate

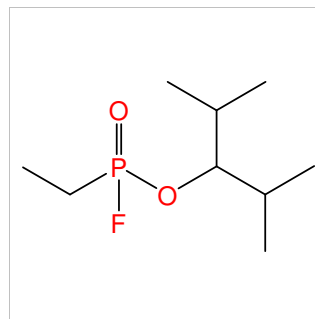

**Chemical name:** 1-Isopropyl-2-methylpropyl isopropylphosphonofluoridate

Schedule: 1A01

CAS RN: 345260-80-2

HS code: 2931.39

Key: 345260-80-2

Molecular formula: C<sub>10</sub>H<sub>22</sub>FO<sub>2</sub>P

CAS Index Name: Phosphonofluoridic acid, 1-methylethyl-, 1-(1-methylethyl)-2-methylpropyl ester

**IUPAC name:** 1-Isopropyl-2-methylpropyl isopropylphosphonofluoridoate

Synonyms: Phosphonofluoridic acid, 1-methylethyl-, 2,4-dimethylpent-3-yl ester

O-1-Isopropyl-2-methylpropyl isopropylphosphonofluoridate

2,4-Dimethylpentan-3-yl isopropylphosphonofluoridate

2,4-Dimethylpent-3-yl isopropylphosphonofluoridate

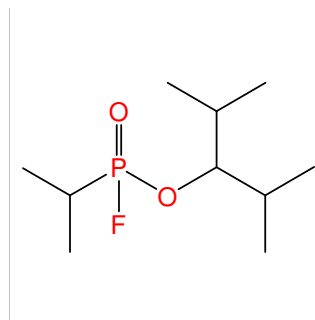

**Chemical name:** 1-Isopropyl-2-methylpropyl propylphosphonofluoridate

Schedule: 1A01

CAS RN: 345260-81-3

HS code: 2931.39

Key: 345260-81-3

Molecular formula: C<sub>10</sub>H<sub>22</sub>FO<sub>2</sub>P

CAS Index Name: Phosphonofluoridic acid, propyl-, 1-(1-methylethyl)-2-methylpropyl ester

**IUPAC name:** 1-Isopropyl-2-methylpropyl propylphosphonofluoridoate

Synonyms: Phosphonofluoridic acid, propyl-, 2,4-dimethylpent-3-yl ester

O-1-Isopropyl-2-methylpropyl propylphosphonofluoridate

2,4-Dimethylpentan-3-yl propylphosphonofluoridate

2,4-Dimethylpent-3-yl propylphosphonofluoridate

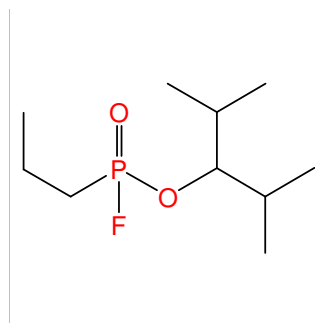

**Chemical name:** 3,7-Dimethyloctyl methylphosphonofluoridate

Schedule: 1A01

CAS RN: 345260-82-4

HS code: 2931.39

Key: 345260-82-4

Molecular formula: C<sub>11</sub>H<sub>24</sub>FO<sub>2</sub>P

CAS Index Name: Phosphonofluoridic acid, methyl-, 3,7-dimethyloctyl ester

**IUPAC name:** 3,7-Dimethyloctyl methylphosphonofluoridoate

Synonyms: O-3,7-Dimethyloctyl methylphosphonofluoridate

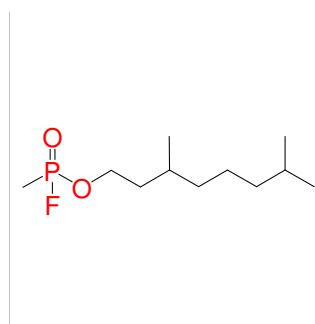

**Chemical name:** 3,7-Dimethyloctyl ethylphosphonofluoridate

Schedule: 1A01

CAS RN: 345260-83-5

HS code: 2931.39

Key: 345260-83-5

Molecular formula: C<sub>12</sub>H<sub>26</sub>FO<sub>2</sub>P

CAS Index Name: Phosphonofluoridic acid, ethyl-, 3,7-dimethyloctyl ester

**IUPAC name:** 3,7-Dimethyloctyl ethylphosphonofluoridoate

Synonyms: O-3,7-Dimethyloctyl ethylphosphonofluoridate

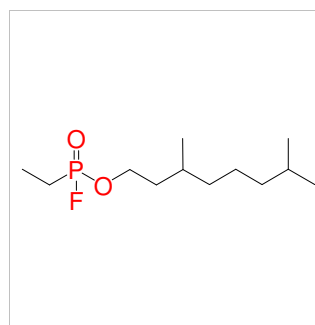

**Chemical name:** 3,7-Dimethyloctyl isopropylphosphonofluoridate

Schedule: 1A01

CAS RN: 345260-84-6

HS code: 2931.39

Key: 345260-84-6

Molecular formula: C<sub>13</sub>H<sub>28</sub>FO<sub>2</sub>P

CAS Index Name: Phosphonofluoridic acid, 1-methylethyl-, 3,7-dimethyloctyl ester

**IUPAC name:** 3,7-Dimethyloctyl isopropylphosphonofluoridoate

Synonyms: O-3,7-Dimethyloctyl isopropylphosphonofluoridate

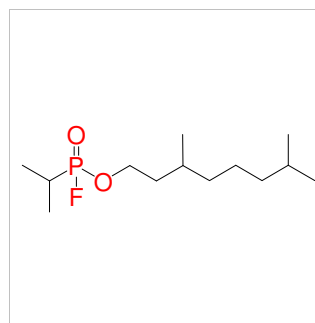

**Chemical name:** 3,7-Dimethyloctyl propylphosphonofluoridate

Schedule: 1A01

CAS RN: 345260-85-7

HS code: 2931.39

Key: 345260-85-7

Molecular formula: C<sub>13</sub>H<sub>28</sub>FO<sub>2</sub>P

CAS Index Name: Phosphonofluoridic acid, propyl-, 3,7-dimethyloctyl ester

**IUPAC name:** 3,7-Dimethyloctyl propylphosphonofluoridoate

Synonyms: O-3,7-Dimethyloctyl propylphosphonofluoridate

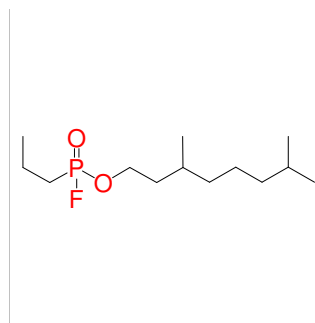

**Chemical name:** 1,3-Dimethylbutyl ethylphosphonofluoridate

Schedule: 1A01

CAS RN: 345260-86-8

HS code: 2931.39

Key: 345260-86-8

Molecular formula: C<sub>8</sub>H<sub>18</sub>FO<sub>2</sub>P

CAS Index Name: Phosphonofluoridic acid, ethyl-, 1,3-dimethylbutyl ester

**IUPAC name:** 1,3-Dimethylbutyl ethylphosphonofluoridoate

Synonyms: O-1,3-Dimethylbutyl ethylphosphonofluoridate

4-Methylpentan-2-yl ethylphosphonofluoridate

4-Methylpent-2-yl ethylphosphonofluoridate

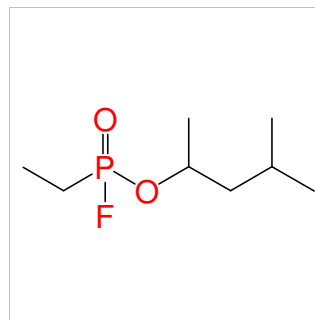

**Chemical name:** 1,3-Dimethylbutyl isopropylphosphonofluoridate

Schedule: 1A01

CAS RN: 345260-87-9

HS code: 2931.39

Key: 345260-87-9

Molecular formula: C<sub>9</sub>H<sub>20</sub>FO<sub>2</sub>P

CAS Index Name: Phosphonofluoridic acid, 1-methylethyl-, 1,3-dimethylbutyl ester

**IUPAC name:** 1,3-Dimethylbutyl isopropylphosphonofluoridoate

Synonyms: O-1,3-Dimethylbutyl isopropylphosphonofluoridate

4-Methylpentan-2-yl isopropylphosphonofluoridate

4-Methylpent-2-yl isopropylphosphonofluoridate

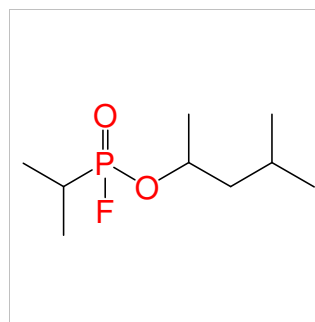



**Chemical name:** 1,3-Dimethylbutyl propylphosphonofluoridate

Schedule: 1A01

CAS RN: 345260-88-0

HS code: 2931.39

Key: 345260-88-0

Molecular formula: C<sub>9</sub>H<sub>20</sub>FO<sub>2</sub>P

CAS Index Name: Phosphonofluoridic acid, propyl-, 1,3-dimethylbutyl ester

**IUPAC name:** 1,3-Dimethylbutyl propylphosphonofluoridoate

Synonyms: O-1,3-Dimethylbutyl propylphosphonofluoridate

4-Methylpentan-2-yl propylphosphonofluoridate

4-Methylpent-2-yl propylphosphonofluoridate

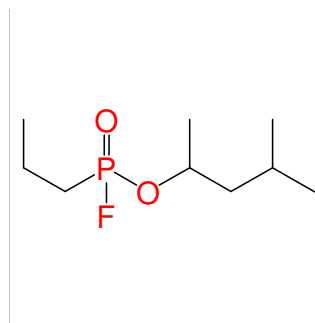

**Chemical name:** sec-Butyl methylphosphonofluoridate

Schedule: 1A01

CAS RN: 352-52-3

HS code: 2931.39

Key: 352-52-3

Molecular formula: C<sub>5</sub>H<sub>12</sub>FO<sub>2</sub>P

CAS Index Name: Phosphonofluoridic acid, methyl-, 1-methylpropyl ester

**IUPAC name:** sec-Butyl methylphosphonofluoridoate

Synonyms: Phosphonofluoridic acid, methyl-, sec-butyl ester

O-sec-Butyl methylphosphonofluoridate

Butan-2-yl methylphosphonofluoridate

But-2-yl methylphosphonofluoridate

1-Methylpropyl methylphosphonofluoridate

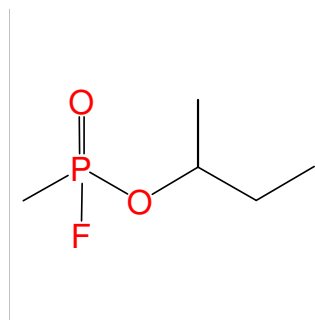

**Chemical name:** 1,3-Dimethylbutyl methylphosphonofluoridate

Schedule: 1A01

CAS RN: 352-53-4

HS code: 2931.39

Key: 352-53-4

Molecular formula: C<sub>7</sub>H<sub>16</sub>FO<sub>2</sub>P

CAS Index Name: Phosphonofluoridic acid, methyl-, 1,3-dimethylbutyl ester

**IUPAC name:** 1,3-Dimethylbutyl methylphosphonofluoridoate

Synonyms: O-1,3-Dimethylbutyl methylphosphonofluoridate

4-Methylpentan-2-yl methylphosphonofluoridate

4-Methylpent-2-yl methylphosphonofluoridate

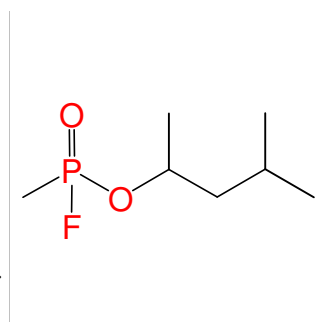

**Chemical name:** Butyl methylphosphonofluoridate

Schedule: 1A01

CAS RN: 352-63-6

HS code: 2931.39

Key: 352-63-6

Molecular formula: C<sub>5</sub>H<sub>12</sub>FO<sub>2</sub>P

CAS Index Name: Phosphonofluoridic acid, methyl-, butyl ester

**IUPAC name:** Butyl methylphosphonofluoridoate

Synonyms: O-n-Butyl methylphosphonofluoridate

O-Butyl methylphosphonofluoridate

n-Butyl methylphosphonofluoridate

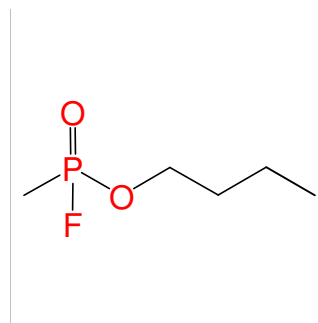

**Chemical name:** Methyl methylphosphonofluoridate

Schedule: 1A01

CAS RN: 353-88-8

HS code: 2931.39

Key: 353-88-8

Molecular formula: C<sub>2</sub>H<sub>6</sub>FO<sub>2</sub>P

CAS Index Name: Phosphonofluoridic acid, methyl-, methyl ester

**IUPAC name:** Methyl methylphosphonofluoridoate

Synonyms: O-Methyl methylphosphonofluoridate

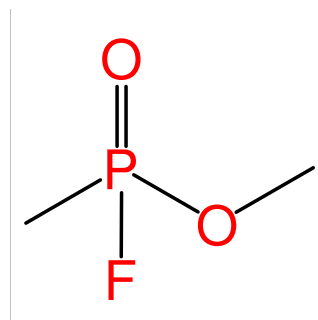

**Chemical name:** 2,2-Dimethylpropyl methylphosphonofluoridate

Schedule: 1A01

CAS RN: 372-62-3

HS code: 2931.39

Key: 372-62-3

Molecular formula: C<sub>6</sub>H<sub>14</sub>FO<sub>2</sub>P

CAS Index Name: Phosphonofluoridic acid, methyl-, 2,2-dimethylpropyl ester

**IUPAC name:** 2,2-Dimethylpropyl methylphosphonofluoridoate

Synonyms: Phosphonofluoridic acid, methyl-, neopentyl ester

O-2,2-Dimethylpropyl methylphosphonofluoridate

Neopentyl methylphosphonofluoridate

1-Propanol, 2,2-dimethyl, methylphosphonofluoridate

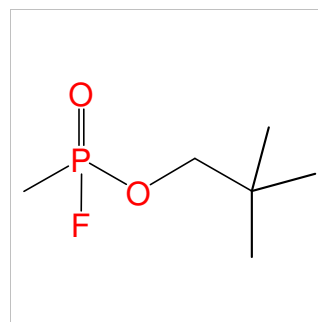

**Chemical name:** 2,2-Dimethylcyclopentyl methylphosphonofluoridate

Schedule: 1A01

CAS RN: 453574-97-5

HS code: 2931.39

Key: 453574-97-5

Molecular formula: C<sub>8</sub>H<sub>16</sub>FO<sub>2</sub>P

CAS Index Name: Phosphonofluoridic acid, methyl-, 2,2-dimethylcyclopentyl ester

**IUPAC name:** 2,2-dimethylcyclopentyl methylphosphonofluoridoate

Synonyms:

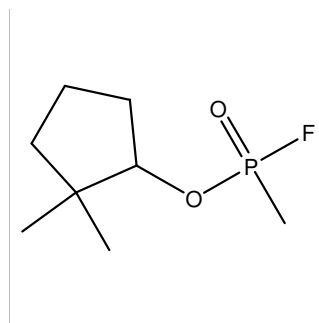

**Chemical name:** 2-Ethylhexyl methylphosphonofluoridate

Schedule: 1A01

CAS RN: 458-71-9

HS code: 2931.39

Key: 458-71-9

Molecular formula: C<sub>9</sub>H<sub>20</sub>FO<sub>2</sub>P

CAS Index Name: Phosphonofluoridic acid, methyl-, 2-ethylhexyl ester

**IUPAC name:** 2-Ethylhexyl methylphosphonofluoridoate

Synonyms: O-2-Ethylhexyl methylphosphonofluoridate

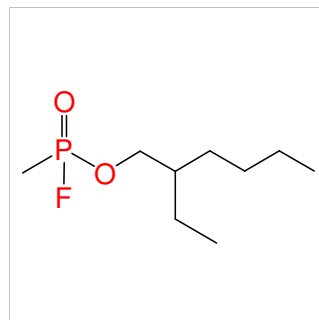

**Chemical name:** 2-Ethylhexyl isopropylphosphonofluoridate

Schedule: 1A01

CAS RN: 460091-27-4

HS code: 2931.39

Key: 460091-27-4

Molecular formula: C<sub>11</sub>H<sub>24</sub>FO<sub>2</sub>P

CAS Index Name: Phosphonofluoridic acid, 1-methylethyl-, 2-ethylhexyl ester

**IUPAC name:** 2-Ethylhexyl isopropylphosphonofluoridoate

Synonyms: O-2-Ethylhexyl isopropylphosphonofluoridate

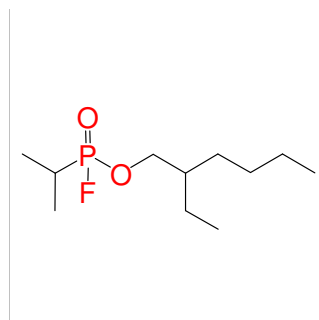

**Chemical name:** 2-Methylbutyl methylphosphonofluoridate

Schedule: 1A01

CAS RN: 468711-90-2

HS code: 2931.39

Key: 468711-90-2

Molecular formula: C<sub>6</sub>H<sub>14</sub>FO<sub>2</sub>P

CAS Index Name: Phosphonofluoridic acid, methyl-, 2-methylbutyl ester

**IUPAC name:** 2-Methylbutyl methylphosphonofluoridoate

Synonyms: O-2-Methylbutyl methylphosphonofluoridate

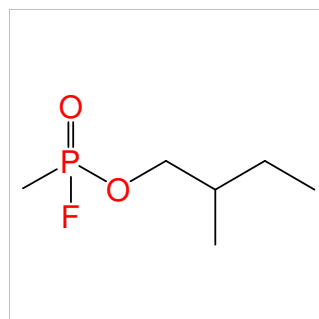

**Chemical name:** 2-Methylbutyl ethylphosphonofluoridate

Schedule: 1A01

CAS RN: 468711-94-6

HS code: 2931.39

Key: 468711-94-6

Molecular formula: C<sub>7</sub>H<sub>16</sub>FO<sub>2</sub>P

CAS Index Name: Phosphonofluoridic acid, ethyl-, 2-methylbutyl ester

**IUPAC name:** 2-Methylbutyl ethylphosphonofluoridoate

Synonyms: O-2-Methylbutyl ethylphosphonofluoridate

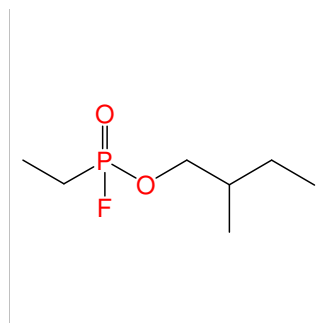

**Chemical name:** 3-Methylbutyl ethylphosphonofluoridate

Schedule: 1A01

CAS RN: 468711-95-7

HS code: 2931.39

Key: 468711-95-7

Molecular formula: C<sub>7</sub>H<sub>16</sub>FO<sub>2</sub>P

CAS Index Name: Phosphonofluoridic acid, ethyl-, 3-methylbutyl ester

**IUPAC name:** 3-Methylbutyl ethylphosphonofluoridoate

Synonyms: O-3-Methylbutyl ethylphosphonofluoridate

Isopentyl ethylphosphonofluoridate

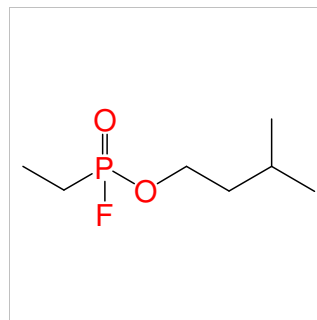

**Chemical name:** 4-Methylcyclohexyl ethylphosphonofluoridate

Schedule: 1A01

CAS RN: 468711-96-8

HS code: 2931.39

Key: 468711-96-8

Molecular formula: C<sub>9</sub>H<sub>18</sub>FO<sub>2</sub>P

CAS Index Name: Phosphonofluoridic acid, ethyl-, 4-methylcyclohexyl ester

**IUPAC name:** 4-Methylcyclohexyl ethylphosphonofluoridoate

Synonyms: O-4-Methylcyclohexyl ethylphosphonofluoridate

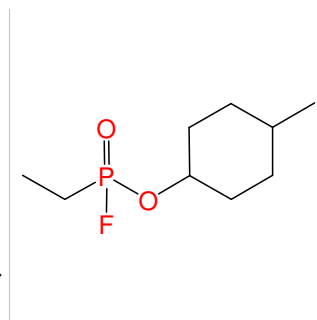

**Chemical name:** 2-Ethylhexyl ethylphosphonofluoridate

Schedule: 1A01

CAS RN: 468711-97-9

HS code: 2931.39

Key: 468711-97-9

Molecular formula: C<sub>10</sub>H<sub>22</sub>FO<sub>2</sub>P

CAS Index Name: Phosphonofluoridic acid, ethyl-, 2-ethylhexyl ester

**IUPAC name:** 2-Ethylhexyl ethylphosphonofluoridoate

Synonyms: O-2-Ethylhexyl ethylphosphonofluoridate

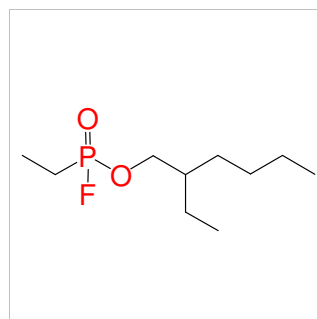

**Chemical name:** 1-Methylheptyl ethylphosphonofluoridate

Schedule: 1A01

CAS RN: 468711-98-0

HS code: 2931.39

Key: 468711-98-0

Molecular formula: C<sub>10</sub>H<sub>22</sub>FO<sub>2</sub>P

CAS Index Name: Phosphonofluoridic acid, ethyl-, 1-methylheptyl ester

**IUPAC name:** 1-Methylheptyl ethylphosphonofluoridoate

Synonyms: Octan-2-yl ethylphosphonofluoridate

Oct-2-yl ethylphosphonofluoridate

O-1-Methylheptyl ethylphosphonofluoridate

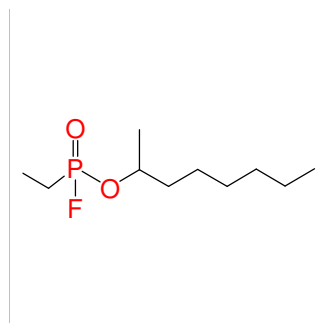

**Chemical name:** sec-Butyl propylphosphonofluoridate

Schedule: 1A01

CAS RN: 468712-01-8

HS code: 2931.39

Key: 468712-01-8

Molecular formula: C<sub>7</sub>H<sub>16</sub>FO<sub>2</sub>P

CAS Index Name: Phosphonofluoridic acid, propyl-, 1-methylpropyl ester

**IUPAC name:** sec-Butyl propylphosphonofluoridoate

Synonyms: O-sec-Butyl propylphosphonofluoridate

Butan-2-yl propylphosphonofluoridate

But-2-yl propylphosphonofluoridate

1-Methylpropyl propylphosphonofluoridate

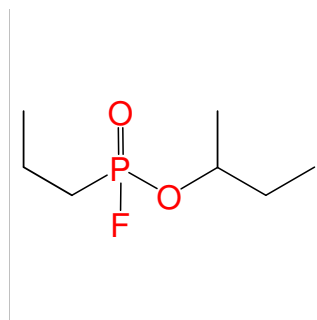

**Chemical name:** 2-Methylbutyl propylphosphonofluoridate

Schedule: 1A01

CAS RN: 468712-02-9

HS code: 2931.39

Key: 468712-02-9

Molecular formula: C<sub>8</sub>H<sub>18</sub>FO<sub>2</sub>P

CAS Index Name: Phosphonofluoridic acid, propyl-, 2-methylbutyl ester

**IUPAC name:** 2-Methylbutyl propylphosphonofluoridoate

Synonyms: O-2-Methylbutyl propylphosphonofluoridate

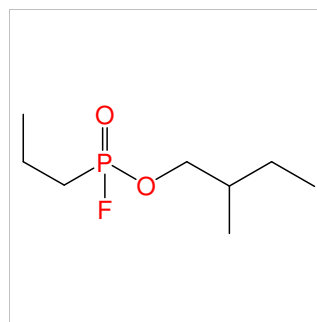

**Chemical name:** 3-Methylbutyl propylphosphonofluoridate

Schedule: 1A01

CAS RN: 468712-03-0

HS code: 2931.39

Key: 468712-03-0

Molecular formula: C<sub>8</sub>H<sub>18</sub>FO<sub>2</sub>P

CAS Index Name: Phosphonofluoridic acid, propyl-, 3-methylbutyl ester

**IUPAC name:** 3-Methylbutyl propylphosphonofluoridoate

Synonyms: O-Isopentyl propylphosphonofluoridate

O-3-Methylbutyl propylphosphonofluoridate

Isopentyl propylphosphonofluoridate

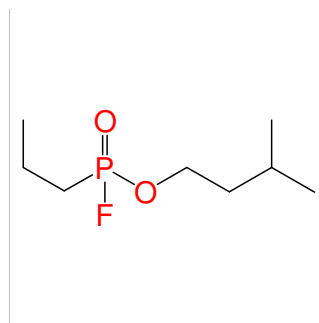

**Chemical name:** 4-Methylcyclohexyl propylphosphonofluoridate

Schedule: 1A01

CAS RN: 468712-04-1

HS code: 2931.39

Key: 468712-04-1

Molecular formula: C<sub>10</sub>H<sub>20</sub>FO<sub>2</sub>P

CAS Index Name: Phosphonofluoridic acid, P-propyl-, 4-methylcyclohexyl ester

**IUPAC name:** 4-methylcyclohexyl propylphosphonofluoridoate

Synonyms: Phosphonofluoridic acid, propyl-, 4-methylcyclohexyl ester

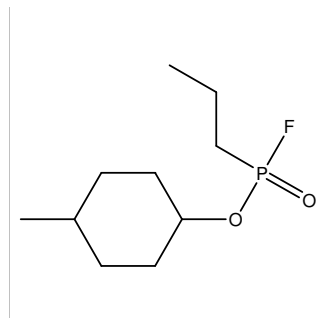

**Chemical name:** 1-Methylheptyl propylphosphonofluoridate

Schedule: 1A01

CAS RN: 468712-06-3

HS code: 2931.39

Key: 468712-06-3

Molecular formula: C<sub>11</sub>H<sub>24</sub>FO<sub>2</sub>P

CAS Index Name: Phosphonofluoridic acid, propyl-, 1-methylheptyl ester

**IUPAC name:** 1-Methylheptyl propylphosphonofluoridoate

Synonyms: Octan-2-yl propylphosphonofluoridate

Oct-2-yl propylphosphonofluoridate

O-1-Methylheptyl propylphosphonofluoridate

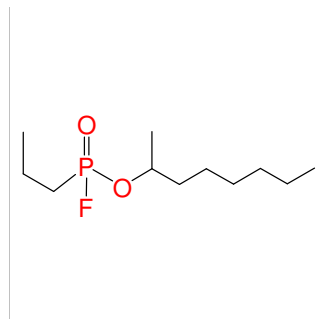

**Chemical name:** sec-Butyl isopropylphosphonofluoridate

Schedule: 1A01

CAS RN: 468712-07-4

HS code: 2931.39

Key: 468712-07-4

Molecular formula: C<sub>7</sub>H<sub>16</sub>FO<sub>2</sub>P

CAS Index Name: Phosphonofluoridic acid, 1-methylethyl-, 1-methylpropyl ester

**IUPAC name:** sec-Butyl isopropylphosphonofluoridoate

Synonyms: O-sec-Butyl isopropylphosphonofluoridate

Butan-2-yl isopropylphosphonofluoridate

But-2-yl isopropylphosphonofluoridate

1-Methylpropyl isopropylphosphonofluoridate

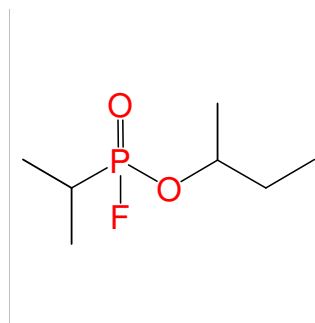

**Chemical name:** 4-Methylcyclohexyl isopropylphosphonofluoridate

Schedule: 1A01

CAS RN: 468712-08-5

HS code: 2931.39

Key: 468712-08-5

Molecular formula: C<sub>10</sub>H<sub>20</sub>FO<sub>2</sub>P

CAS Index Name: Phosphonofluoridic acid, 1-methylethyl-, 4-methylcyclohexyl ester

**IUPAC name:** 4-Methylcyclohexyl isopropylphosphonofluoridoate

Synonyms: O-4-Methylcyclohexyl isopropylphosphonofluoridate

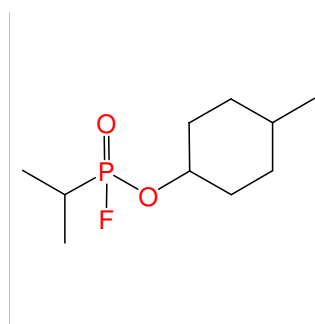

**Chemical name:** 1-Methylheptyl isopropylphosphonofluoridate

Schedule: 1A01

CAS RN: 468712-09-6

HS code: 2931.39

Key: 468712-09-6

Molecular formula: C<sub>11</sub>H<sub>24</sub>FO<sub>2</sub>P

CAS Index Name: Phosphonofluoridic acid, 1-methylethyl-, 1-methylheptylester

**IUPAC name:** 1-Methylheptyl isopropylphosphonofluoridoate

Synonyms: Octan-2-yl 1-methylethylphosphonofluoridate

Oct-2-yl 1-methylethylphosphonofluoridate

O-1-Methylheptyl isopropylphosphonofluoridate

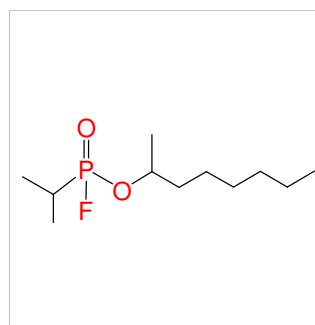

**Chemical name:** 1,2-Dimethylpropyl methylphosphonofluoridate

Schedule: 1A01

CAS RN: 6154-51-4

HS code: 2931.39

Key: 6154-51-4

Molecular formula: C<sub>6</sub>H<sub>14</sub>FO<sub>2</sub>P

CAS Index Name: Phosphonofluoridic acid, methyl-, 1,2-dimethylpropyl ester

**IUPAC name:** 1,2-Dimethylpropyl methylphosphonofluoridoate

Synonyms: O-1,2-Dimethylpropyl methylphosphonofluoridate

3-Methylbutan-2-yl methylphosphonofluoridate

3-Methylbut-2-yl methylphosphonofluoridate

2-Butanol, 3-methyl-, methylphosphonofluoridate

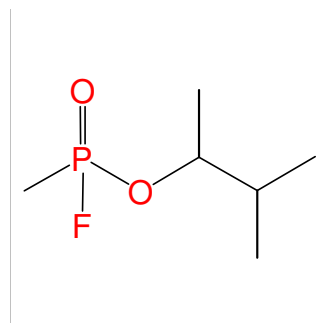

**Chemical name:** Methyl isopropylphosphonofluoridate

Schedule: 1A01

CAS RN: 648-59-9

HS code: 2931.39

Key: 648-59-9

Molecular formula: C<sub>4</sub>H<sub>10</sub>FO<sub>2</sub>P

CAS Index Name: Phosphonofluoridic acid, (1-methylethyl)-, methyl ester

**IUPAC name:** Methyl isopropylphosphonofluoridoate

Synonyms: O-Methyl isopropylphosphonofluoridate

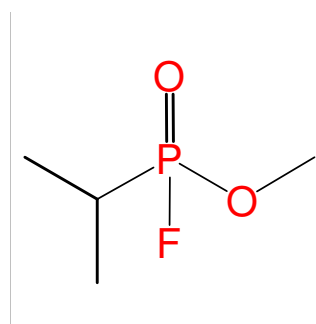

**Chemical name:** Ethyl ethylphosphonofluoridate

Schedule: 1A01

CAS RN: 650-20-4

HS code: 2931.39

Key: 650-20-4

Molecular formula: C<sub>4</sub>H<sub>10</sub>FO<sub>2</sub>P

CAS Index Name: Phosphonofluoridic acid, ethyl-, ethyl ester

**IUPAC name:** Ethyl ethylphosphonofluoridoate

Synonyms: O-Ethyl ethylphosphonofluoridate

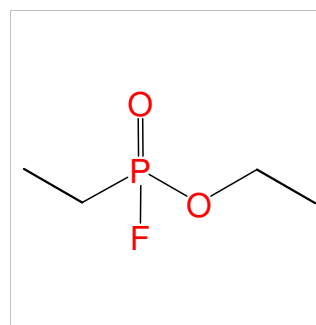

**Chemical name:** 3,3-Dimethylbutyl methylphosphonofluoridate

Schedule: 1A01

CAS RN: 660-21-9

HS code: 2931.39

Key: 660-21-9

Molecular formula: C<sub>7</sub>H<sub>16</sub>FO<sub>2</sub>P

CAS Index Name: Phosphonofluoridic acid, methyl-, 3,3-dimethylbutyl ester

**IUPAC name:** 3,3-Dimethylbutyl methylphosphonofluoridoate

Synonyms: O-3,3-Dimethylbutyl methylphosphonofluoridate

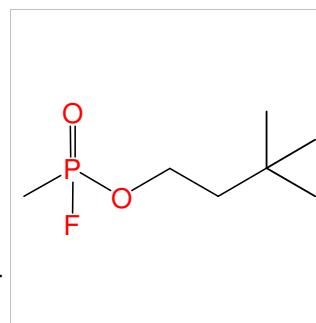



**Chemical name:** 1-Ethylpropyl methylphosphonofluoridate

Schedule: 1A01

CAS RN: 66348-71-8

HS code: 2931.39

Key: 66348-71-8

Molecular formula: C<sub>6</sub>H<sub>14</sub>FO<sub>2</sub>P

CAS Index Name: Phosphonofluoridic acid, methyl-, 1-ethylpropyl ester

**IUPAC name:** 1-Ethylpropyl methylphosphonofluoridoate

Synonyms: Pentan-3-yl methylphosphonofluoridate

Pent-3-yl methylphosphonofluoridate

O-1-Ethylpropyl methylphosphonofluoridate

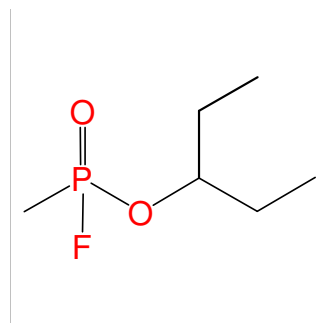

**Chemical name:** Methyl ethylphosphonofluoridate

Schedule: 1A01

CAS RN: 665-03-2

HS code: 2931.39

Key: 665-03-2

Molecular formula: C<sub>3</sub>H<sub>8</sub>FO<sub>2</sub>P

CAS Index Name: Phosphonofluoridic acid, ethyl-, methyl ester

**IUPAC name:** Methyl ethylphosphonofluoridoate

Synonyms: O-Methyl ethylphosphonofluoridate

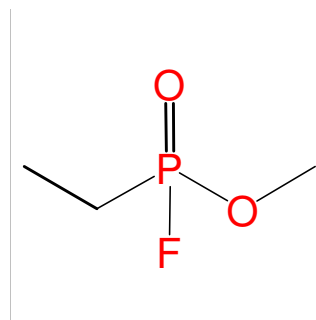

**Chemical name:** Isopropyl isopropylphosphonofluoridate

Schedule: 1A01

CAS RN: 665-33-8

HS code: 2931.39

Key: 665-33-8

Molecular formula: C<sub>6</sub>H<sub>14</sub>FO<sub>2</sub>P

CAS Index Name: Phosphonofluoridic acid, (1-methylethyl)-, 1-methylethyl ester

**IUPAC name:** Isopropyl isopropylphosphonofluoridoate

Synonyms: Phosphonofluoridic acid, isopropyl-, isopropyl ester

O-Isopropyl isopropylphosphonofluoridate

Diisopropylphosphonofluoridate

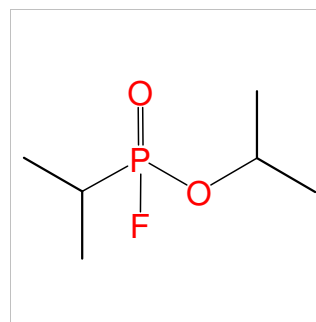

**Chemical name:** Ethyl methylphosphonofluoridate

Schedule: 1A01

CAS RN: 673-97-2

HS code: 2931.39

Key: 673-97-2

Molecular formula: C<sub>3</sub>H<sub>8</sub>FO<sub>2</sub>P

CAS Index Name: Phosphonofluoridic acid, methyl-, ethyl ester

**IUPAC name:** Ethyl methylphosphonofluoridoate

Synonyms: O-Ethyl methylphosphonofluoridate

Ethyl methylphosphonofluoride

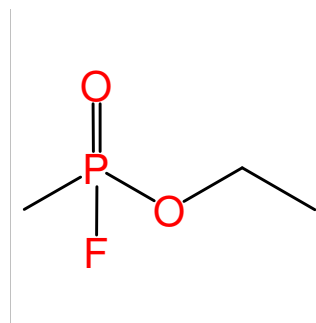

**Chemical name:** 1-Methylhexyl methylphosphonofluoridate

Schedule: 1A01

CAS RN: 674-95-3

HS code: 2931.39

Key: 674-95-3

Molecular formula: C<sub>8</sub>H<sub>18</sub>FO<sub>2</sub>P

CAS Index Name: Phosphonofluoridic acid, methyl-, 1-methylhexyl ester

**IUPAC name:** 1-Methylhexyl methylphosphonofluoridoate

Synonyms: O-1-Methylhexyl methylphosphonofluoridate

Heptan-2-yl methylphosphonofluoridate

Hept-2-yl methylphosphonofluoridate

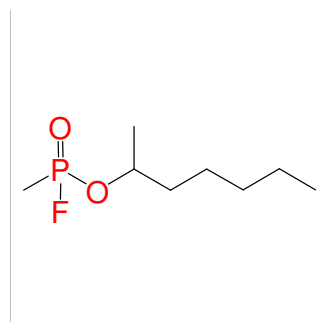

**Chemical name:** Cyclopentyl methylphosphonofluoridate

Schedule: 1A01

CAS RN: 7284-82-4

HS code: 2931.39

Key: 7284-82-4

Molecular formula: C<sub>6</sub>H<sub>12</sub>FO<sub>2</sub>P

CAS Index Name: Phosphonofluoridic acid, methyl-, cyclopentyl ester

**IUPAC name:** Cyclopentyl methylphosphonofluoridoate

Synonyms: O-Cyclopentyl methylphosphonofluoridate

Cyclopentanol, methylphosphonofluoridate

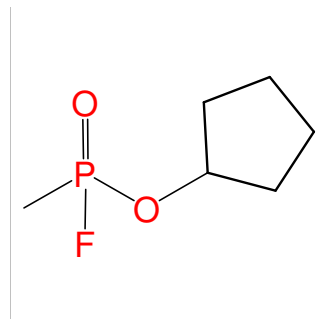

**Chemical name:** Cycloheptyl methylphosphonofluoridate

Schedule: 1A01

CAS RN: 7284-83-5

HS code: 2931.39

Key: 7284-83-5

Molecular formula: C<sub>8</sub>H<sub>16</sub>FO<sub>2</sub>P

CAS Index Name: Phosphonofluoridic acid, methyl-, cycloheptyl ester

**IUPAC name:** Cycloheptyl methylphosphonofluoridoate

Synonyms: O-Cycloheptyl methylphosphonofluoridate

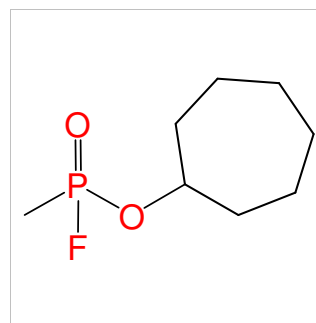

**Chemical name:** Cyclohexyl ethylphosphonofluoridate

Schedule: 1A01

CAS RN: 7284-84-6

HS code: 2931.39

Key: 7284-84-6

Molecular formula: C<sub>8</sub>H<sub>16</sub>FO<sub>2</sub>P

CAS Index Name: Phosphonofluoridic acid, ethyl-, cyclohexyl ester

**IUPAC name:** Cyclohexyl ethylphosphonofluoridoate

Synonyms: O-Cyclohexyl ethylphosphonofluoridate

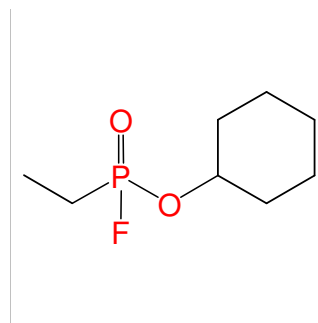

**Chemical name:** 1-Methylbutyl methylphosphonofluoridate

Schedule: 1A01

CAS RN: 761-93-3

HS code: 2931.39

Key: 761-93-3

Molecular formula: C<sub>6</sub>H<sub>14</sub>FO<sub>2</sub>P

CAS Index Name: Phosphonofluoridic acid, methyl-, 1-methylbutyl ester

**IUPAC name:** 1-Methylbutyl methylphosphonofluoridoate

Synonyms: Pentan-2-yl methylphosphonofluoridate

Pent-2-yl methylphosphonofluoridate

O-1-Methylbutyl methylphosphonofluoridate

2-Pentanol, methylphosphonofluoridate

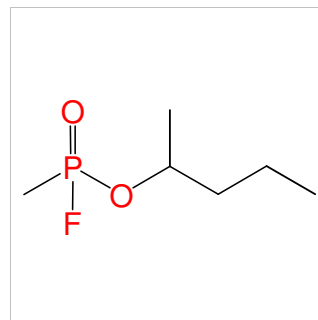

**Chemical name:** Propyl methylphosphonofluoridate

Schedule: 1A01

CAS RN: 763-14-4

HS code: 2931.39

Key: 763-14-4

Molecular formula: C<sub>4</sub>H<sub>10</sub>FO<sub>2</sub>P

CAS Index Name: Phosphonofluoridic acid, methyl-, propyl ester

**IUPAC name:** Propyl methylphosphonofluoridoate

Synonyms: O-Propyl methylphosphonofluoridate

O-n-Propyl methylphosphonofluoridate

n-Propyl methylphosphonofluoridate

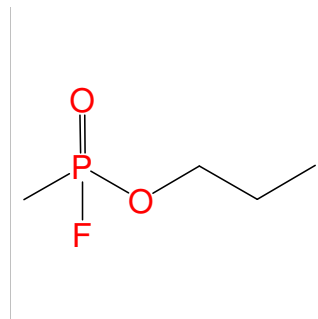

**Chemical name:** 2,3-Dimethylbutyl methylphosphonofluoridate

Schedule: 1A01

CAS RN: 83563-66-0

HS code: 2931.39

Key: 83563-66-0

Molecular formula: C<sub>7</sub>H<sub>16</sub>FO<sub>2</sub>P

CAS Index Name: Phosphonofluoridic acid, methyl-, 2,3-dimethylbutyl ester

**IUPAC name:** 2,3-Dimethylbutyl methylphosphonofluoridoate

Synonyms: O-2,3-Dimethylbutyl methylphosphonofluoridate

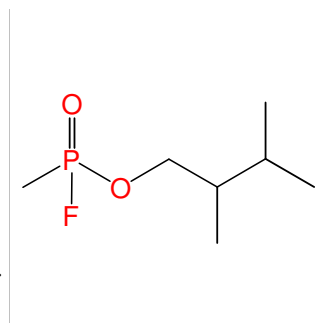

**Chemical name:** 2-Methylcyclohexyl methylphosphonofluoridate

Schedule: 1A01

CAS RN: 85473-32-1

HS code: 2931.39

Key: 85473-32-1

Molecular formula: C<sub>8</sub>H<sub>16</sub>FO<sub>2</sub>P

CAS Index Name: Phosphonofluoridic acid, methyl-, 2-methylcyclohexyl ester

**IUPAC name:** 2-Methylcyclohexyl methylphosphonofluoridoate

Synonyms: O-2-Methylcyclohexyl methylphosphonofluoridate

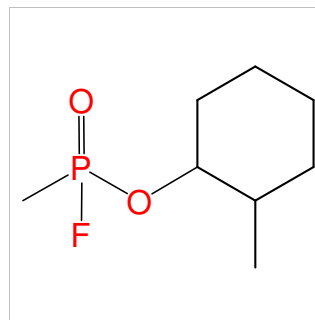

**Chemical name:** 2,2-Dimethylpropyl isopropylphosphonofluoridate

Schedule: 1A01

CAS RN: 864463-26-3

HS code: 2931.39

Key: 864463-26-3

Molecular formula: C<sub>8</sub>H<sub>18</sub>FO<sub>2</sub>P

CAS Index Name: Phosphonofluoridic acid, 1-methylethyl-, 2,2-dimethylpropyl ester

**IUPAC name:** 2,2-Dimethylpropyl isopropylphosphonofluoridoate

Synonyms: O-Neopentyl isopropylphosphonofluoridate

O-2,2-Dimethylpropyl isopropylphosphonofluoridate

Neopentyl isopropylphosphonofluoridate

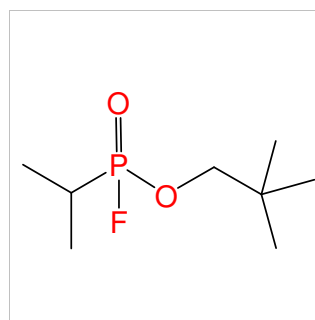

**Chemical name:** Pentyl N-ethyl-N-propylphosphoramidocyanidate

Schedule: 1A01

CAS RN: 870124-20-2

HS code: 2931.39

Key: 870124-20-2

Molecular formula: C<sub>11</sub>H<sub>23</sub>N<sub>2</sub>O<sub>2</sub>P

CAS Index Name: Phosphoramidocyanidic acid, ethylpropyl-, pentyl ester

**IUPAC name:** Pentyl ethyl(propyl)phosphoramidocyanidoate

Synonyms:

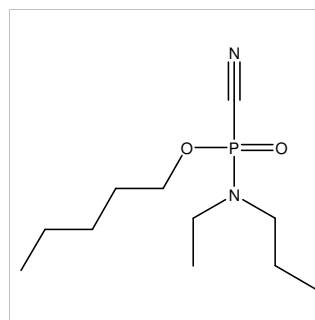

**Chemical name:** (1S)-Pinacolyl methylphosphonofluoridate

Schedule: 1A01

CAS RN: 89254-45-5

HS code: 2931.39

Key: 89254-45-5

Molecular formula: C<sub>7</sub>H<sub>16</sub>FO<sub>2</sub>P

CAS Index Name: Phosphonofluoridic acid, methyl-, 1,2,2-trimethylpropyl ester, (1S)-

**IUPAC name:** (1S)-1,2,2-Trimethylpropyl methylphosphonofluoridoate

Synonyms: O-(1S)- Pinacolyl methylphosphonofluoridate  
(2S)-3,3-Dimethylbutan-2-yl methylphosphonofluoridate  
(2S)-3,3-Dimethylbut-2-yl methylphosphonofluoridate  
(1S)-1,2,2-Trimethylpropyl methylphosphonofluoridate

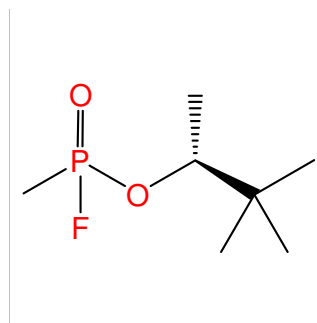

**Chemical name:** (1R)-Pinacolyl methylphosphonofluoridate

Schedule: 1A01

CAS RN: 89254-46-6

HS code: 2931.39

Key: 89254-46-6

Molecular formula: C<sub>7</sub>H<sub>16</sub>FO<sub>2</sub>P

CAS Index Name: Phosphonofluoridic acid, methyl-, 1,2,2-trimethylpropyl ester, (1R)-

**IUPAC name:** (1R)-1,2,2-Trimethylpropyl methylphosphonofluoridoate

Synonyms: O-(1R)-Pinacolyl methylphosphonofluoridate  
(2R)-3,3-Dimethylbutan-2-yl methylphosphonofluoridate  
(2R)-3,3-Dimethylbut-2-yl methylphosphonofluoridate  
(1R)-1,2,2-Trimethylpropyl methylphosphonofluoridate

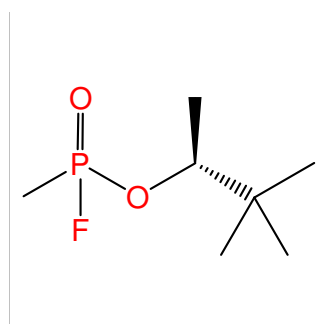

**Chemical name:** Pinacolyl propylphosphonofluoridate

Schedule: 1A01

CAS RN: 952104-35-7

HS code: 2931.39

Key: 952104-35-7

Molecular formula: C<sub>9</sub>H<sub>20</sub>FO<sub>2</sub>P

CAS Index Name: Phosphonofluoridic acid, propyl-, 1,2,2-trimethylpropyl ester

**IUPAC name:** 1,2,2-Trimethylpropyl propylphosphonofluoridoate

Synonyms: O-Pinacolyl propylphosphonofluoridate  
O-1,2,2-Trimethylpropyl propylphosphonofluoridate  
3,3-Dimethylbutan-2-yl propylphosphonofluoridate  
3,3-Dimethylbut-2-yl propylphosphonofluoridate

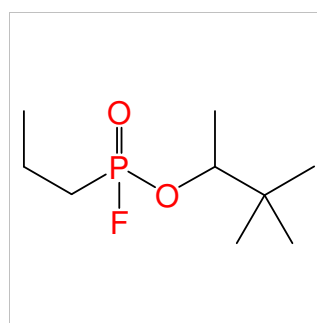

**Chemical name:** 2-Ethylhexyl propylphosphonofluoridate

Schedule: 1A01

CAS RN: 952104-36-8

HS code: 2931.39

Key: 952104-36-8

Molecular formula: C<sub>11</sub>H<sub>24</sub>FO<sub>2</sub>P

CAS Index Name: Phosphonofluoridic acid, propyl-, 2-ethylhexyl ester

**IUPAC name:** 2-Ethylhexyl propylphosphonofluoridoate

Synonyms: O-2-Ethylhexyl propylphosphonofluoridate

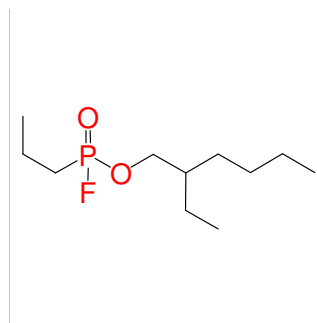

**Chemical name:** 2-Methylbutyl isopropylphosphonofluoridate

Schedule: 1A01

CAS RN: 952104-39-1

HS code: 2931.39

Key: 952104-39-1

Molecular formula: C<sub>8</sub>H<sub>18</sub>FO<sub>2</sub>P

CAS Index Name: Phosphonofluoridic acid, 1-methylethyl-, 2-methylbutyl ester

**IUPAC name:** 2-Methylbutyl isopropylphosphonofluoridoate

Synonyms: O-2-Methylbutyl isopropylphosphonofluoridate

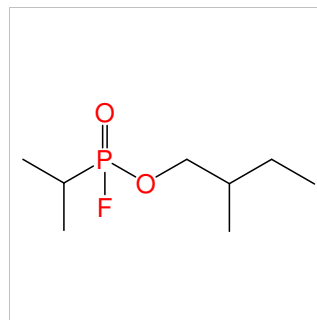

**Chemical name:** 3-Methylbutyl isopropylphosphonofluoridate

Schedule: 1A01

CAS RN: 952104-40-4

HS code: 2931.39

Key: 952104-40-4

Molecular formula: C<sub>8</sub>H<sub>18</sub>FO<sub>2</sub>P

CAS Index Name: Phosphonofluoridic acid, 1-methylethyl-, 3-methylbutyl ester

**IUPAC name:** 3-Methylbutyl isopropylphosphonofluoridoate

Synonyms: O-Isopentyl isopropylphosphonofluoridate

O-3-Methylbutyl isopropylphosphonofluoridate

Isopentyl isopropylphosphonofluoridate

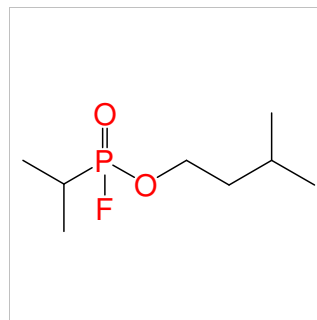

**Chemical name:** Pinacolyl isopropylphosphonofluoridate

Schedule: 1A01

CAS RN: 952104-41-5

HS code: 2931.39

Key: 952104-41-5

Molecular formula: C<sub>9</sub>H<sub>20</sub>FO<sub>2</sub>P

CAS Index Name: Phosphonofluoric acid, 1-methylethyl-, 1,2,2-trimethylpropyl ester

**IUPAC name:** 1,2,2-Trimethylpropyl isopropylphosphonofluoridoate

Synonyms: O-Pinacolyl isopropylphosphonofluoridate

O-1,2,2-Trimethylpropyl isopropylphosphonofluoridate

3,3-Dimethylbutan-2-yl isopropylphosphonofluoridate

3,3-Dimethylbut-2-yl isopropylphosphonofluoridate

2,2-Dimethylbut-3-yl isopropylphosphonofluoridate

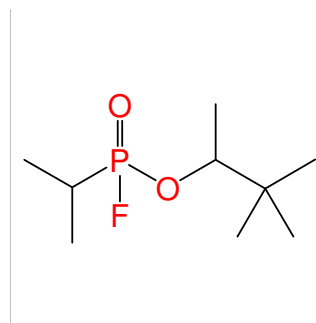

**Chemical name:** 4-tert-Butylcyclohexyl propylphosphonofluoridate

Schedule: 1A01

CAS RN: 959004-03-6

HS code: 2931.39

Key: 959004-03-6

Molecular formula: C<sub>13</sub>H<sub>26</sub>FO<sub>2</sub>P

CAS Index Name: Phosphonofluoric acid, propyl-, 4-(1,1-dimethylethyl)cyclohexyl ester

**IUPAC name:** 4-tert-Butylcyclohexyl propylphosphonofluoridoate

Synonyms: O-4-tert-Butylcyclohexyl propylphosphonofluoridate

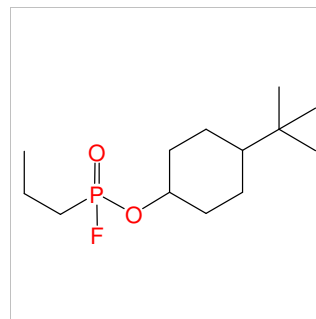

**Chemical name:** 3,3-Dimethylbutyl propylphosphonofluoridate

Schedule: 1A01

CAS RN: 959004-32-1

HS code: 2931.39

Key: 959004-32-1

Molecular formula: C<sub>9</sub>H<sub>20</sub>FO<sub>2</sub>P

CAS Index Name: Phosphonofluoric acid, propyl-, 3,3-dimethylbutyl ester

**IUPAC name:** 3,3-Dimethylbutyl propylphosphonofluoridoate

Synonyms: O-3,3-Dimethylbutyl propylphosphonofluoridate

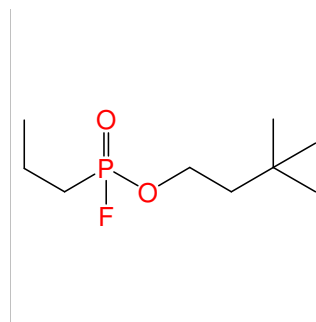

**Chemical name:** Cyclohexylmethyl isopropylphosphonofluoridate

Schedule: 1A01

CAS RN: 959004-34-3

HS code: 2931.39

Key: 959004-34-3

Molecular formula: C<sub>10</sub>H<sub>20</sub>FO<sub>2</sub>P

CAS Index Name: Phosphonofluoridic acid, 1-methylethyl-, cyclohexylmethyl ester

**IUPAC name:** Cyclohexylmethyl isopropylphosphonofluoridoate

Synonyms: O-Cyclohexylmethyl isopropylphosphonofluoridate

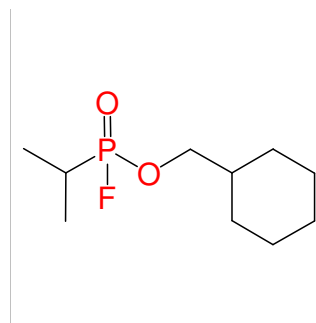

**Chemical name:** 2-Cyclohexylethyl propylphosphonofluoridate

Schedule: 1A01

CAS RN: 959004-37-6

HS code: 2931.39

Key: 959004-37-6

Molecular formula: C<sub>11</sub>H<sub>22</sub>FO<sub>2</sub>P

CAS Index Name: Phosphonofluoridic acid, propyl-, 2-cyclohexylethyl ester

**IUPAC name:** 2-Cyclohexylethyl propylphosphonofluoridoate

Synonyms: O-2-Cyclohexylethyl propylphosphonofluoridate

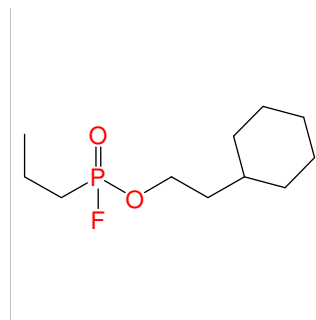

**Chemical name:** 4-Methylpentyl methylphosphonofluoridate

Schedule: 1A01

CAS RN: 959010-20-9

HS code: 2931.39

Key: 959010-20-9

Molecular formula: C<sub>7</sub>H<sub>16</sub>FO<sub>2</sub>P

CAS Index Name: Phosphonofluoridic acid, methyl-, 4-methylpentyl ester

**IUPAC name:** 4-Methylpentyl methylphosphonofluoridoate

Synonyms: O-4-Methylpentyl methylphosphonofluoridate

Isohexyl methylphosphonofluoridate

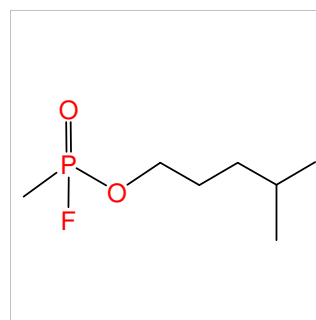

**Chemical name:** 1,1-Dimethylpentyl methylphosphonofluoridate

Schedule: 1A01

CAS RN: 959014-89-2

HS code: 2931.39

Key: 959014-89-2

Molecular formula: C<sub>8</sub>H<sub>18</sub>FO<sub>2</sub>P

CAS Index Name: Phosphonofluoridic acid, methyl-, 1,1-dimethylpentyl ester

**IUPAC name:** 1,1-Dimethylpentyl methylphosphonofluoridoate

Synonyms: O-1,1-Dimethylpentyl methylphosphonofluoridate

2-Methylhexan-2-yl methylphosphonofluoridate

2-Methyl-2-hexyl methylphosphonofluoridate

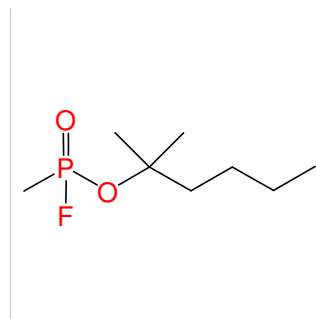



**Chemical name:** Cyclohexylmethyl methylphosphonofluoridate

Schedule: 1A01

CAS RN: 959019-47-7

HS code: 2931.39

Key: 959019-47-7

Molecular formula: C<sub>8</sub>H<sub>16</sub>FO<sub>2</sub>P

CAS Index Name: Phosphonofluoridic acid, methyl-, cyclohexylmethyl ester

**IUPAC name:** Cyclohexylmethyl methylphosphonofluoridoate

Synonyms: O-Cyclohexylmethyl methylphosphonofluoridate

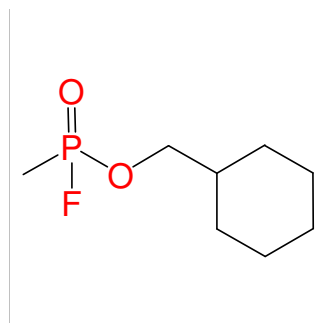

**Chemical name:** Cyclohexylmethyl propylphosphonofluoridate

Schedule: 1A01

CAS RN: 959025-93-5

HS code: 2931.39

Key: 959025-93-5

Molecular formula: C<sub>10</sub>H<sub>20</sub>FO<sub>2</sub>P

CAS Index Name: Phosphonofluoridic acid, propyl-, cyclohexylmethyl ester

**IUPAC name:** Cyclohexylmethyl propylphosphonofluoridoate

Synonyms: O-Cyclohexylmethyl propylphosphonofluoridate

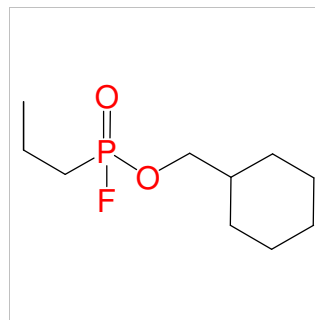

**Chemical name:** 3,5,5-Trimethylhexyl ethylphosphonofluoridate

Schedule: 1A01

CAS RN: 959027-88-4

HS code: 2931.39

Key: 959027-88-4

Molecular formula: C<sub>11</sub>H<sub>24</sub>FO<sub>2</sub>P

CAS Index Name: Phosphonofluoridic acid, ethyl-, 3,5,5-trimethylhexyl ester

**IUPAC name:** 3,5,5-Trimethylhexyl ethylphosphonofluoridoate

Synonyms: O-3,5,5-Trimethylhexyl ethylphosphonofluoridate

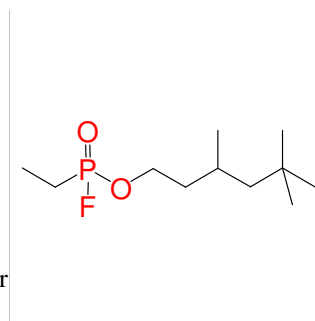

**Chemical name:** 2-Cyclohexylethyl methylphosphonofluoridate

Schedule: 1A01

CAS RN: 959040-72-3

HS code: 2931.39

Key: 959040-72-3

Molecular formula: C<sub>9</sub>H<sub>18</sub>FO<sub>2</sub>P

CAS Index Name: Phosphonofluoridic acid, methyl-, 2-cyclohexylethyl ester

**IUPAC name:** 2-Cyclohexylethyl methylphosphonofluoridoate

Synonyms: O-2-Cyclohexylethyl methylphosphonofluoridate

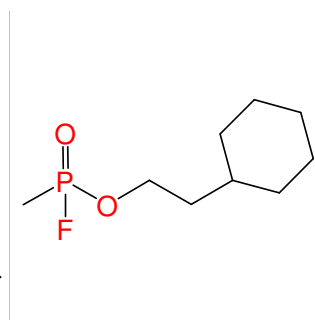

**Chemical name:** 1-Ethyl-1-methylpropyl methylphosphonofluoridate

Schedule: 1A01

CAS RN: 959083-58-0

HS code: 2931.39

Key: 959083-58-0

Molecular formula: C<sub>7</sub>H<sub>16</sub>FO<sub>2</sub>P

CAS Index Name: Phosphonofluoridic acid, methyl-, 1-ethyl-1-methylpropyl ester

**IUPAC name:** 3-methylpentan-3-yl methylphosphonofluoridate

Synonyms: O-1-Ethyl-1-methylpropyl methylphosphonofluoridate

3-Methylpentan-3-yl methylphosphonofluoridate

3-Methylpentan-3-yl methylphosphonofluoridate

3-Methylpent-3-yl methylphosphonofluoridate

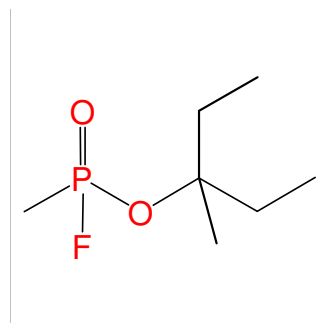

**Chemical name:** 1-Ethylpropyl ethylphosphonofluoridate

Schedule: 1A01

CAS RN: 959086-48-7

HS code: 2931.39

Key: 959086-48-7

Molecular formula: C<sub>7</sub>H<sub>16</sub>FO<sub>2</sub>P

CAS Index Name: Phosphonofluoridic acid, ethyl-, 1-ethylpropyl ester

**IUPAC name:** 1-Ethylpropyl ethylphosphonofluoridate

Synonyms: Pentan-3-yl ethylphosphonofluoridate

Pent-3-yl ethylphosphonofluoridate

O-1-Ethylpropyl ethylphosphonofluoridate

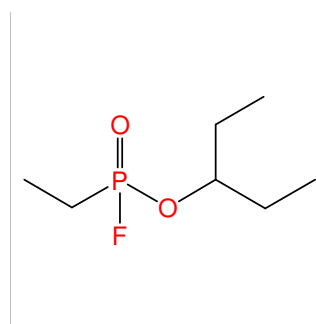

**Chemical name:** 1-Ethylhexyl isopropylphosphonofluoridate

Schedule: 1A01

CAS RN: 959088-13-2

HS code: 2931.39

Key: 959088-13-2

Molecular formula: C<sub>11</sub>H<sub>24</sub>FO<sub>2</sub>P

CAS Index Name: Phosphonofluoridic acid, 1-methylethyl-, 1-ethylhexyl ester

**IUPAC name:** 1-Ethylhexyl isopropylphosphonofluoridate

Synonyms: Phosphonofluoridic acid, 1-methylethyl-, oct-3-yl ester

Octan-3-yl isopropylphosphonofluoridate

Oct-3-yl isopropylphosphonofluoridate

O-1-Ethylhexyl isopropylphosphonofluoridate

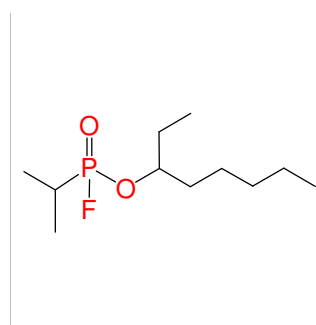

**Chemical name:** 1-Ethylhexyl propylphosphonofluoridate

Schedule: 1A01

CAS RN: 959088-14-3

HS code: 2931.39

Key: 959088-14-3

Molecular formula: C<sub>11</sub>H<sub>24</sub>FO<sub>2</sub>P

CAS Index Name: Phosphonofluoridic acid, propyl-, 1-ethylhexyl ester

**IUPAC name:** 1-Ethylhexyl propylphosphonofluoridoate

Synonyms: Phosphonofluoridic acid, propyl-, oct-3-yl ester

Octan-3-yl propylphosphonofluoridate

Oct-3-yl propylphosphonofluoridate

O-1-Ethylhexyl propylphosphonofluoridate

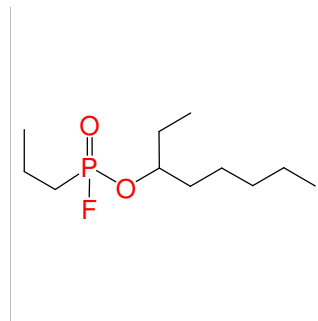

**Chemical name:** 1-Ethylpropyl propylphosphonofluoridate

Schedule: 1A01

CAS RN: 959088-15-4

HS code: 2931.39

Key: 959088-15-4

Molecular formula: C<sub>8</sub>H<sub>18</sub>FO<sub>2</sub>P

CAS Index Name: Phosphonofluoridic acid, propyl-, 1-ethylpropyl ester

**IUPAC name:** 1-Ethylpropyl propylphosphonofluoridoate

Synonyms: Pentan-3-yl propylphosphonofluoridate

Pent-3-yl propylphosphonofluoridate

O-1-Ethylpropyl propylphosphonofluoridate

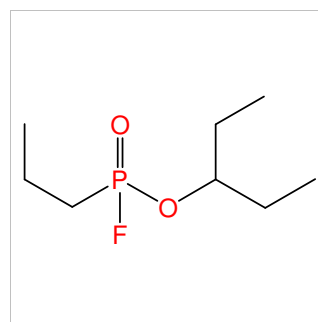

**Chemical name:** 2-Propylpentyl methylphosphonofluoridate

Schedule: 1A01

CAS RN: 959089-00-0

HS code: 2931.39

Key: 959089-00-0

Molecular formula: C<sub>9</sub>H<sub>20</sub>FO<sub>2</sub>P

CAS Index Name: Phosphonofluoridic acid, methyl-, 2-propylpentyl ester

**IUPAC name:** 2-Propylpentyl methylphosphonofluoridoate

Synonyms: O-2-Propylpentyl methylphosphonofluoridate

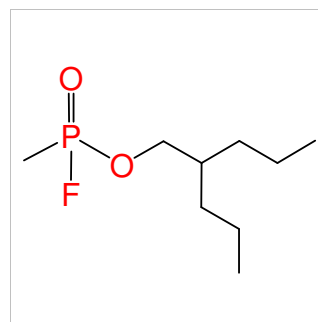

**Chemical name:** 2,2-Dimethylpropyl propylphosphonofluoridate

Schedule: 1A01

CAS RN: 959092-42-3

HS code: 2931.39

Key: 959092-42-3

Molecular formula: C<sub>8</sub>H<sub>18</sub>FO<sub>2</sub>P

CAS Index Name: Phosphonofluoridic acid, propyl-, 2,2-dimethylpropyl ester

**IUPAC name:** 2,2-Dimethylpropyl propylphosphonofluoridoate

Synonyms: O-Neopentyl propylphosphonofluoridate

O-2,2-Dimethylpropyl propylphosphonofluoridate

Neopentyl propylphosphonofluoridate

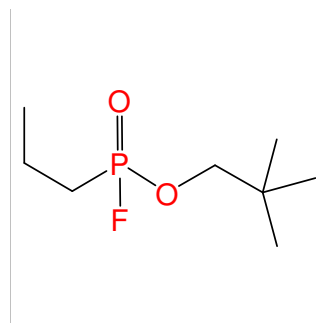

**Chemical name:** 2-Cyclohexylethyl ethylphosphonofluoridate

Schedule: 1A01

CAS RN: 959093-03-9

HS code: 2931.39

Key: 959093-03-9

Molecular formula: C<sub>10</sub>H<sub>20</sub>FO<sub>2</sub>P

CAS Index Name: Phosphonofluoridic acid, ethyl-, 2-cyclohexylethyl ester

**IUPAC name:** 2-Cyclohexylethyl ethylphosphonofluoridoate

Synonyms: O-2-Cyclohexylethyl ethylphosphonofluoridate

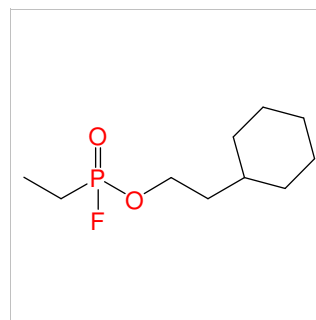

**Chemical name:** Cyclohexylmethyl ethylphosphonofluoridate

Schedule: 1A01

CAS RN: 959093-05-1

HS code: 2931.39

Key: 959093-05-1

Molecular formula: C<sub>9</sub>H<sub>18</sub>FO<sub>2</sub>P

CAS Index Name: Phosphonofluoridic acid, ethyl-, cyclohexylmethyl ester

**IUPAC name:** Cyclohexylmethyl ethylphosphonofluoridoate

Synonyms: O-Cyclohexylmethyl ethylphosphonofluoridate

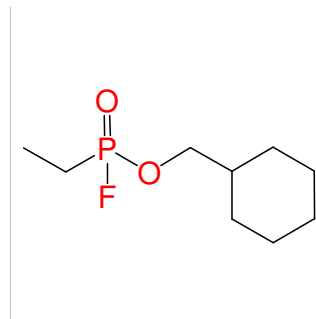

**Chemical name:** 1-Propylheptyl methylphosphonofluoridate

Schedule: 1A01

CAS RN: 959098-86-3

HS code: 2931.39

Key: 959098-86-3

Molecular formula: C<sub>11</sub>H<sub>24</sub>FO<sub>2</sub>P

CAS Index Name: Phosphonofluoridic acid, methyl-, 1-propylheptyl ester

**IUPAC name:** 1-Propylheptyl methylphosphonofluoridoate

Synonyms: O-1-Propylheptyl methylphosphonofluoridate

Decan-4-yl methylphosphonofluoridate

Dec-4-yl methylphosphonofluoridate

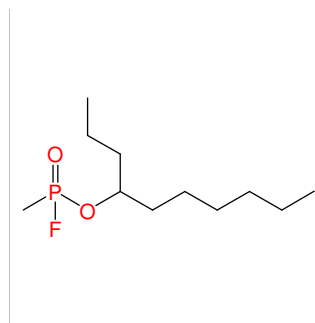

**Chemical name:** 1-Ethyl-1-methylpentyl methylphosphonofluoridate

Schedule: 1A01

CAS RN: 959098-88-5

HS code: 2931.39

Key: 959098-88-5

Molecular formula: C<sub>9</sub>H<sub>20</sub>FO<sub>2</sub>P

CAS Index Name: Phosphonofluoridic acid, methyl-, 1-ethyl-1-methylpentyl ester

**IUPAC name:** 3-methylheptan-3-yl methylphosphonofluoridate

Synonyms: O-1-Ethyl-1-methylpentyl methylphosphonofluoridate

3-Methylheptan-3-yl methylphosphonofluoridate

3-Methylhept-3-yl methylphosphonofluoridate

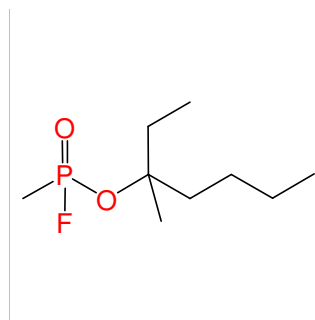

**Chemical name:** 1-Ethylpentyl methylphosphonofluoridate

Schedule: 1A01

CAS RN: 959098-89-6

HS code: 2931.39

Key: 959098-89-6

Molecular formula: C<sub>8</sub>H<sub>18</sub>FO<sub>2</sub>P

CAS Index Name: Phosphonofluoridic acid, methyl-, 1-ethylpentyl ester

**IUPAC name:** 1-Ethylpentyl methylphosphonofluoridoate

Synonyms: Phosphonofluoridic acid, methyl-, hept-3-yl ester

O-1-Ethylpentyl methylphosphonofluoridate

Heptan-3-yl methylphosphonofluoridate

Hept-3-yl methylphosphonofluoridate

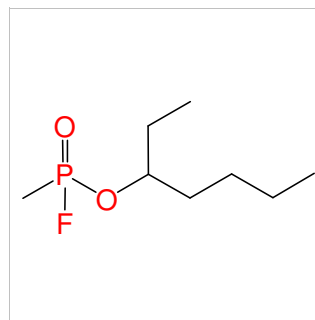

**Chemical name:** 1-Propylheptyl ethylphosphonofluoridate

Schedule: 1A01

CAS RN: 959217-15-3

HS code: 2931.39

Key: 959217-15-3

Molecular formula: C<sub>12</sub>H<sub>26</sub>FO<sub>2</sub>P

CAS Index Name: Phosphonofluoridic acid, ethyl-, 1-propylheptylester

**IUPAC name:** 1-Propylheptyl ethylphosphonofluoridoate

Synonyms: O-1-Propylheptyl ethylphosphonofluoridate

Decan-4-yl ethylphosphonofluoridate

Dec-4-yl ethylphosphonofluoridate

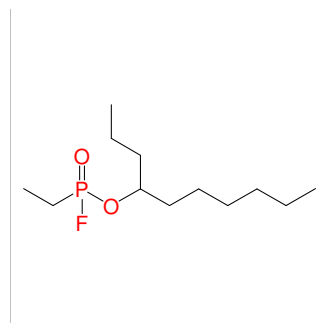

**Chemical name:** 4-tert-Butylcyclohexyl ethylphosphonofluoridate

Schedule: 1A01

CAS RN: 959217-22-2

HS code: 2931.39

Key: 959217-22-2

Molecular formula: C<sub>12</sub>H<sub>24</sub>FO<sub>2</sub>P

CAS Index Name: Phosphonofluoridic acid, ethyl-, 4-(1,1-dimethylethyl)cyclohexyl ester

**IUPAC name:** 4-tert-Butylcyclohexyl ethylphosphonofluoridoate

Synonyms: O-4-tert-Butylcyclohexyl ethylphosphonofluoridate

4-(1,1-dimethylethyl)cyclohexyl ethylphosphonofluoridate

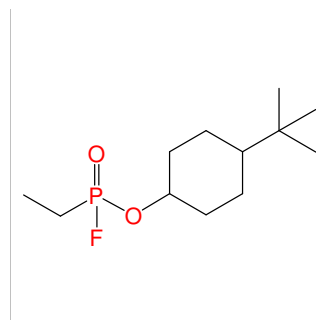

**Chemical name:** 1-Ethylbutyl methylphosphonofluoridate

Schedule: 1A01

CAS RN: 959218-68-9

HS code: 2931.39

Key: 959218-68-9

Molecular formula: C<sub>7</sub>H<sub>16</sub>FO<sub>2</sub>P

CAS Index Name: Phosphonofluoridic acid, methyl-, 1-ethylbutyl ester

**IUPAC name:** 1-Ethylbutyl methylphosphonofluoridoate

Synonyms: O-1-Ethylbutyl methylphosphonofluoridate

Hexan-3-yl methylphosphonofluoridate

Hex-3-yl methylphosphonofluoridate

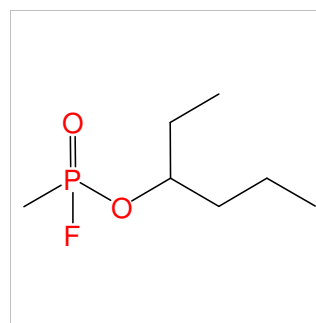

**Chemical name:** 2,2-Dimethylpropyl ethylphosphonofluoridate

Schedule: 1A01

CAS RN: 959234-06-1

HS code: 2931.39

Key: 959234-06-1

Molecular formula: C<sub>7</sub>H<sub>16</sub>FO<sub>2</sub>P

CAS Index Name: Phosphonofluoridic acid, ethyl-, 2,2-dimethylpropyl ester

**IUPAC name:** 2,2-Dimethylpropyl ethylphosphonofluoridoate

Synonyms: O-2,2-Dimethylpropyl ethylphosphonofluoridate

Neopentyl ethylphosphonofluoridate

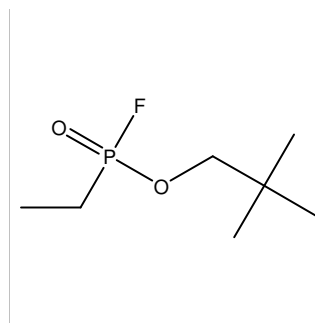

**Chemical name:** 4-tert-Butylcyclohexyl methylphosphonofluoridate

Schedule: 1A01

CAS RN: 959245-06-8

HS code: 2931.39

Key: 959245-06-8

Molecular formula: C<sub>11</sub>H<sub>22</sub>FO<sub>2</sub>P

CAS Index Name: Phosphonofluoridic acid, methyl-, 4-(1,1-dimethylethyl)cyclohexyl ester

**IUPAC name:** 4-tert-Butylcyclohexyl methylphosphonofluoridoate

Synonyms: O-4-tert-Butylcyclohexyl methylphosphonofluoridate

4-(1,1-Dimethylethyl)cyclohexyl methylphosphonofluoridate

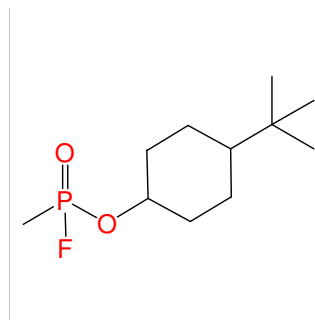

**Chemical name:** 1,1-Diethylpropyl methylphosphonofluoridate

Schedule: 1A01

CAS RN: 959257-62-6

HS code: 2931.39

Key: 959257-62-6

Molecular formula: C<sub>8</sub>H<sub>18</sub>FO<sub>2</sub>P

CAS Index Name: Phosphonofluoridic acid, methyl-, 1,1-diethylpropyl ester

**IUPAC name:** 3-ethylpentan-3-yl methylphosphonofluoridate

Synonyms: O-1,1-Diethylpropyl methylphosphonofluoridate

3-Ethylpentan-3-yl methylphosphonofluoridate

3-Ethylpent-3-yl methylphosphonofluoridate

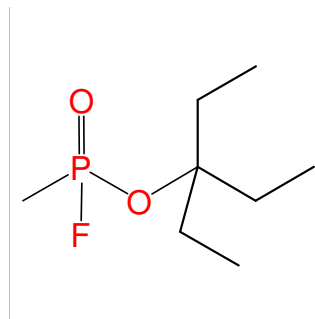

**Chemical name:** 1-Isobutyl-3-methylbutyl ethylphosphonofluoridate

Schedule: 1A01

CAS RN: 959262-99-8

HS code: 2931.39

Key: 959262-99-8

Molecular formula: C<sub>11</sub>H<sub>24</sub>FO<sub>2</sub>P

CAS Index Name: Phosphonofluoric acid, ethyl-, 1-isobutyl-3-methylbutyl ester

**IUPAC name:** 1-Isobutyl-3-methylbutyl ethylphosphonofluoridate

Synonyms: Phosphonofluoric acid, ethyl-, 2,6-dimethylhept-4-yl ester

O-1-Isobutyl-3-methylbutyl ethylphosphonofluoridate

3-Methyl-1-(2-methylpropyl)butyl ethylphosphonofluoridate

2,6-Dimethylheptan-4-yl ethylphosphonofluoridate

2,6-Dimethylhept-4-yl ethylphosphonofluoridate

1-Isobutylisopentyl ethylphosphonofluoridate

1-(2-Methylpropyl)-3-methylbutyl ethylphosphonofluoridate

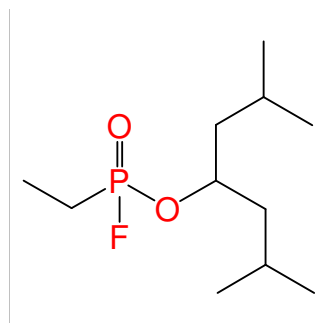

**Chemical name:** 3-Methylpentyl ethylphosphonofluoridate

Schedule: 1A01

CAS RN: 959263-01-5

HS code: 2931.39

Key: 959263-01-5

Molecular formula: C<sub>8</sub>H<sub>18</sub>FO<sub>2</sub>P

CAS Index Name: Phosphonofluoric acid, ethyl-, 3-methylpentyl ester

**IUPAC name:** 3-Methylpentyl ethylphosphonofluoridate

Synonyms: O-3-Methylpentyl ethylphosphonofluoridate

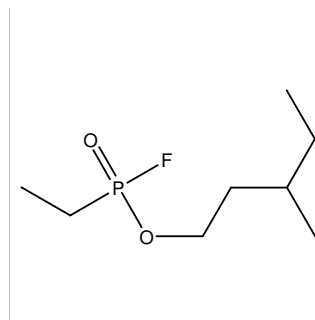

**Chemical name:** 4-Methylpentyl ethylphosphonofluoridate

Schedule: 1A01

CAS RN: 959276-46-1

HS code: 2931.39

Key: 959276-46-1

Molecular formula: C<sub>8</sub>H<sub>18</sub>FO<sub>2</sub>P

CAS Index Name: Phosphonofluoric acid, ethyl-, 4-methylpentyl ester

**IUPAC name:** 4-Methylpentyl ethylphosphonofluoridate

Synonyms: O-4-Methylpentyl ethylphosphonofluoridate

Isohexyl ethylphosphonofluoridate

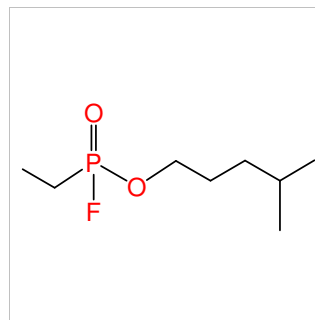



**Chemical name:** 3,5,5-Trimethylhexyl methylphosphonofluoridate

Schedule: 1A01

CAS RN: 959304-14-4

HS code: 2931.39

Key: 959304-14-4

Molecular formula: C<sub>10</sub>H<sub>22</sub>FO<sub>2</sub>P

CAS Index Name: Phosphonofluoric acid, methyl-, 3,5,5-trimethylhexyl ester

**IUPAC name:** 3,5,5-Trimethylhexyl methylphosphonofluoridoate

Synonyms: O-3,5,5-Trimethylhexyl methylphosphonofluoridate

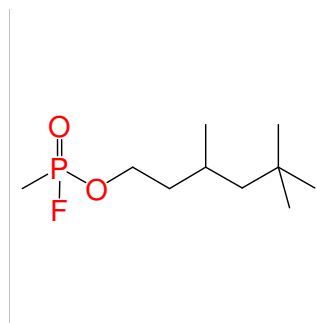

**Chemical name:** Pinacolyl methylphosphonofluoridate

Schedule: 1A01

CAS RN: 96-64-0

HS code: 2931.39

Key: 96-64-0

Molecular formula: C<sub>7</sub>H<sub>16</sub>FO<sub>2</sub>P

CAS Index Name: Phosphonofluoric acid, methyl-, 1,2,2-trimethylpropyl ester

**IUPAC name:** 1,2,2-Trimethylpropyl methylphosphonofluoridoate

Synonyms: Soman

PMFP

Pinacolyl methylfluorophosphonate

Pinacoloxymethylphosphoryl fluoride

Phosphine oxide, fluoromethyl(1,2,2-trimethylpropoxy)-

O-Pinacolyl methylphosphonofluoridate

Methyl pinacolylphosphoryl fluoride

Methyl pinacolyl phosphonofluoridate

GD (chemical warfare agent)

GD

3,3-Dimethylbutan-2-yl methylphosphonofluoridate

3,3-Dimethylbut-2-yl methylphosphonofluoridate

2,2-Dimethylbut-3-yl methylphosphonofluoridate

1,2,2-Trimethylpropyl methylphosphonofluoridate

1,2,2-Trimethylpropoxyfluorophosphine oxide

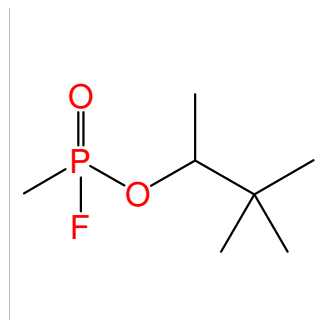

**Chemical name:** Pinacolyl ethylphosphonofluoridate

Schedule: 1A01

CAS RN: 97931-20-9

HS code: 2931.39

Key: 97931-20-9

Molecular formula: C<sub>8</sub>H<sub>18</sub>FO<sub>2</sub>P

CAS Index Name: Phosphonofluoridic acid, ethyl-, 1,2,2-trimethylpropyl ester

**IUPAC name:** 1,2,2-Trimethylpropyl ethylphosphonofluoridoate

Synonyms: O-Pinacolyl ethylphosphonofluoridate

3,3-Dimethylbutan-2-yl ethylphosphonofluoridate

3,3-Dimethylbut-2-yl ethylphosphonofluoridate

1,2,2-Trimethylpropyl ethylphosphonofluoridate

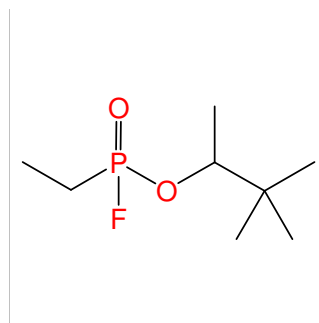

**Chemical name:** Cyclohexylmethyl N,N-diethylphosphoramidocyanidate

Schedule: 1A02

CAS RN:

HS code:

Key: (100-49-2)-1A2-EE

Molecular formula: C<sub>12</sub>H<sub>23</sub>N<sub>2</sub>O<sub>2</sub>P

CAS Index Name:

**IUPAC name:**

Synonyms:

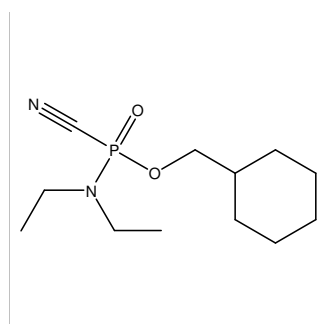

**Chemical name:** Cyclohexylmethyl N,N-diisopropylphosphoramidocyanidate

Schedule: 1A02

CAS RN:

HS code: 2931.39

Key: (100-49-2)-1A2-II

Molecular formula: C<sub>14</sub>H<sub>27</sub>N<sub>2</sub>O<sub>2</sub>P

CAS Index Name:

**IUPAC name:**

Synonyms:

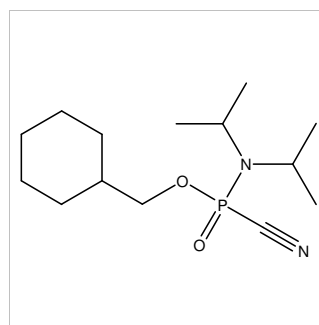

**Chemical name:** 2-Ethylhexyl N,N-diethylphosphoramidocyanidate

Schedule: 1A02

CAS RN: HS code: 2931.39

Key: (104-76-7)-1A2-EE

Molecular formula: C<sub>13</sub>H<sub>27</sub>N<sub>2</sub>O<sub>2</sub>P

CAS Index Name:

**IUPAC name:**

Synonyms:

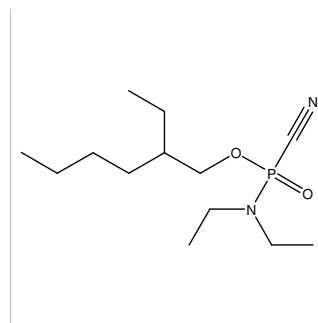

**Chemical name:** 2-Ethylhexyl N-ethyl-N-isopropylphosphoramidocyanidate

Schedule: 1A02

CAS RN: HS code: 2931.39

Key: (104-76-7)-1A2-EI

Molecular formula: C<sub>14</sub>H<sub>29</sub>N<sub>2</sub>O<sub>2</sub>P

CAS Index Name:

**IUPAC name:**

Synonyms:

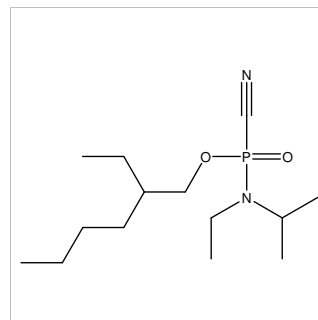

**Chemical name:** 2-Ethylhexyl N-ethyl-N-methylphosphoramidocyanidate

Schedule: 1A02

CAS RN: HS code: 2931.39

Key: (104-76-7)-1A2-EM

Molecular formula: C<sub>12</sub>H<sub>25</sub>N<sub>2</sub>O<sub>2</sub>P

CAS Index Name:

**IUPAC name:**

Synonyms:

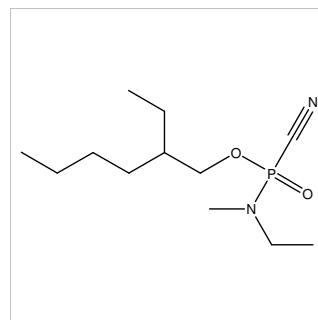

**Chemical name:** 2-Ethylhexyl N-ethyl-N-propylphosphoramidocyanidate

Schedule: 1A02

CAS RN: HS code: 2931.39

Key: (104-76-7)-1A2-EP

Molecular formula: C<sub>14</sub>H<sub>29</sub>N<sub>2</sub>O<sub>2</sub>P

CAS Index Name:

**IUPAC name:**

Synonyms:

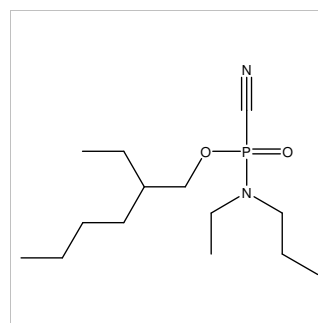

**Chemical name:** 2-Ethylhexyl N,N-diisopropylphosphoramidocyanidate

Schedule: 1A02

CAS RN:

HS code: 2931.39

Key: (104-76-7)-1A2-II

Molecular formula: C<sub>15</sub>H<sub>31</sub>N<sub>2</sub>O<sub>2</sub>P

CAS Index Name:

**IUPAC name:**

Synonyms:

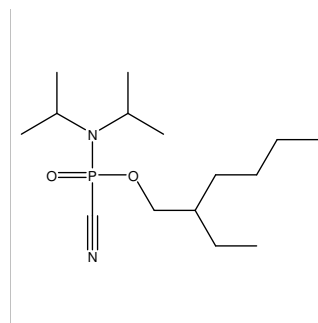

**Chemical name:** 2-Ethylhexyl N-isopropyl-N-methylphosphoramidocyanidate

Schedule: 1A02

CAS RN:

HS code: 2931.39

Key: (104-76-7)-1A2-IM

Molecular formula: C<sub>13</sub>H<sub>27</sub>N<sub>2</sub>O<sub>2</sub>P

CAS Index Name:

**IUPAC name:**

Synonyms:

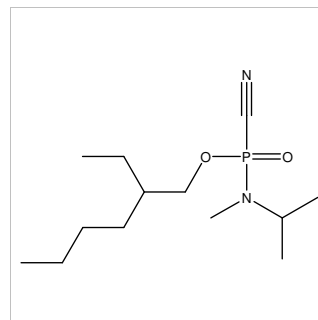

**Chemical name:** 2-Ethylhexyl N-methyl-N-propylphosphoramidocyanidate

Schedule: 1A02

CAS RN:

HS code: 2931.39

Key: (104-76-7)-1A2-MP

Molecular formula: C<sub>13</sub>H<sub>27</sub>N<sub>2</sub>O<sub>2</sub>P

CAS Index Name:

**IUPAC name:**

Synonyms:

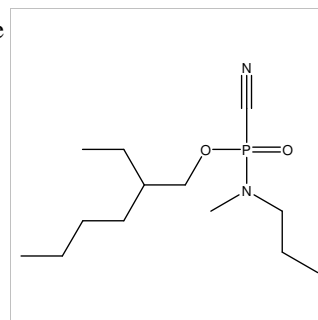

**Chemical name:** 2-Ethylhexyl N,N-dipropylphosphoramidocyanidate

Schedule: 1A02

CAS RN:

HS code: 2931.39

Key: (104-76-7)-1A2-PP

Molecular formula: C<sub>15</sub>H<sub>31</sub>N<sub>2</sub>O<sub>2</sub>P

CAS Index Name:

**IUPAC name:**

Synonyms:

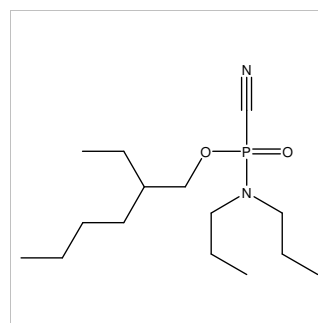

**Chemical name:** 2-Methylpentyl N,N-dimethylphosphoramidocyanidate

Schedule: 1A02

CAS RN:

HS code: 2931.39

Key: (105-30-6)-1A2-MM

Molecular formula: C<sub>9</sub>H<sub>19</sub>N<sub>2</sub>O<sub>2</sub>P

CAS Index Name:

**IUPAC name:**

Synonyms:

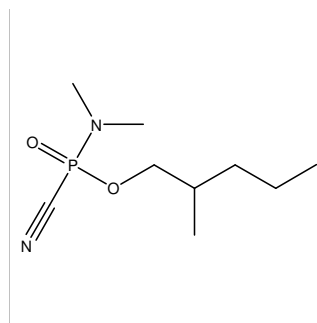

**Chemical name:** 3,7-Dimethyloctyl N,N-diethylphosphoramidocyanidate

Schedule: 1A02

CAS RN:

HS code: 2931.39

Key: (106-21-8)-1A2-EE

Molecular formula: C<sub>15</sub>H<sub>31</sub>N<sub>2</sub>O<sub>2</sub>P

CAS Index Name:

**IUPAC name:**

Synonyms:

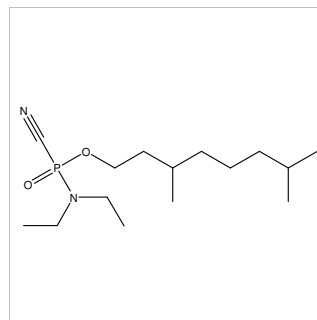

**Chemical name:** 3,7-Dimethyloctyl N,N-diisopropylphosphoramidocyanidate

Schedule: 1A02

CAS RN:

HS code: 2931.39

Key: (106-21-8)-1A2-II

Molecular formula: C<sub>17</sub>H<sub>35</sub>N<sub>2</sub>O<sub>2</sub>P

CAS Index Name:

**IUPAC name:**

Synonyms:

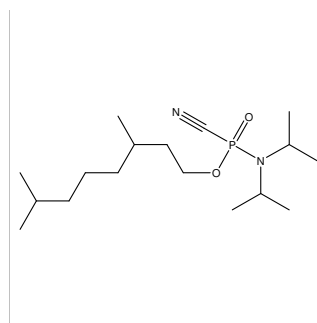

**Chemical name:** 3,7-Dimethyloctyl N,N-dimethylphosphoramidocyanidate

Schedule: 1A02

CAS RN:

HS code: 2931.39

Key: (106-21-8)-1A2-MM

Molecular formula: C<sub>13</sub>H<sub>27</sub>N<sub>2</sub>O<sub>2</sub>P

CAS Index Name:

**IUPAC name:**

Synonyms:

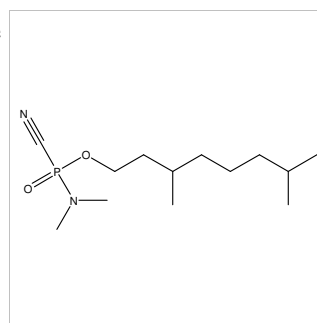

**Chemical name:** 3,7-Dimethyloctyl N,N-dipropylphosphoramidocyanidate

Schedule: 1A02

CAS RN:

HS code: 2931.39

Key: (106-21-8)-1A2-PP

Molecular formula: C<sub>17</sub>H<sub>35</sub>N<sub>2</sub>O<sub>2</sub>P

CAS Index Name:

**IUPAC name:**

Synonyms:

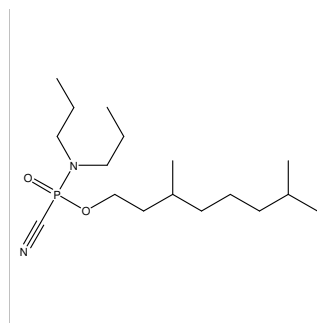

**Chemical name:** 1,3-Dimethylbutyl N,N-diethylphosphoramidocyanidate

Schedule: 1A02

CAS RN:

HS code: 2931.39

Key: (108-11-2)-1A2-EE

Molecular formula: C<sub>11</sub>H<sub>23</sub>N<sub>2</sub>O<sub>2</sub>P

CAS Index Name:

**IUPAC name:**

Synonyms:

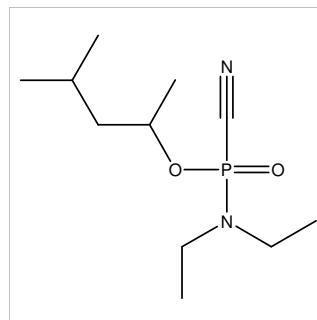

**Chemical name:** 1,3-Dimethylbutyl N,N-dipropylphosphoramidocyanidate

Schedule: 1A02

CAS RN:

HS code: 2931.39

Key: (108-11-2)-1A2-PP

Molecular formula: C<sub>13</sub>H<sub>27</sub>N<sub>2</sub>O<sub>2</sub>P

CAS Index Name:

**IUPAC name:**

Synonyms:

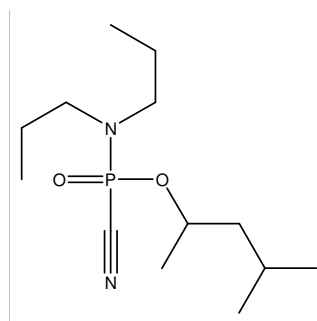

**Chemical name:** 1-Isobutyl-3-methylbutyl N,N-dimethylphosphoramidocyanidate

Schedule: 1A02

CAS RN:

HS code: 2931.39

Key: (108-82-7)-1A2-MM

Molecular formula: C<sub>12</sub>H<sub>25</sub>N<sub>2</sub>O<sub>2</sub>P

CAS Index Name:

**IUPAC name:**

Synonyms:

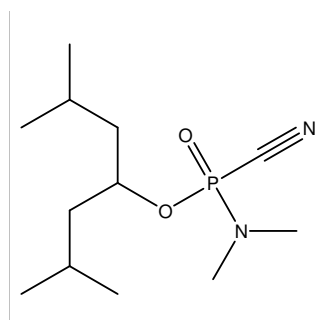

**Chemical name:** Cyclohexyl N-ethyl-N-isopropylphosphoramidocyanidate

Schedule: 1A02

CAS RN:

HS code: 2931.39

Key: (108-93-0)-1A2-Ei

Molecular formula: C<sub>12</sub>H<sub>23</sub>N<sub>2</sub>O<sub>2</sub>P

CAS Index Name:

**IUPAC name:**

Synonyms:

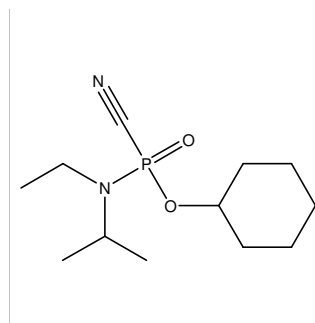

**Chemical name:** Cyclohexyl N-ethyl-N-methylphosphoramidocyanidate

Schedule: 1A02

CAS RN:

HS code: 2931.39

Key: (108-93-0)-1A2-EM

Molecular formula: C<sub>10</sub>H<sub>19</sub>N<sub>2</sub>O<sub>2</sub>P

CAS Index Name:

**IUPAC name:**

Synonyms:

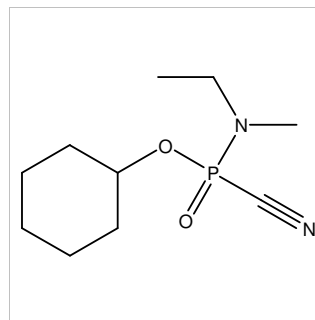

**Chemical name:** Cyclohexyl N-ethyl-N-propylphosphoramidocyanidate

Schedule: 1A02

CAS RN:

HS code: 2931.39

Key: (108-93-0)-1A2-EP

Molecular formula: C<sub>12</sub>H<sub>23</sub>N<sub>2</sub>O<sub>2</sub>P

CAS Index Name:

**IUPAC name:**

Synonyms:

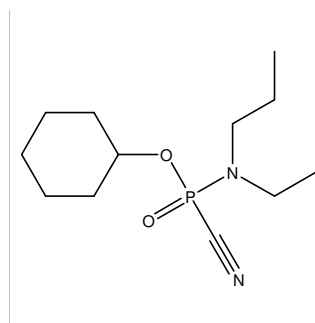

**Chemical name:** Cyclohexyl N,N-diisopropylphosphoramidocyanidate

Schedule: 1A02

CAS RN:

HS code: 2931.39

Key: (108-93-0)-1A2-II

Molecular formula: C<sub>13</sub>H<sub>25</sub>N<sub>2</sub>O<sub>2</sub>P

CAS Index Name: Phosphoramidocyanidic acid, bis(1-methylethyl)-, cyclohexyl ester

**IUPAC name:** Cyclohexyl diisopropylphosphoramidocyanidoate

Synonyms: O-Cyclohexyl N,N-diisopropylphosphoramidocyanidate

Cyclohexyl diisopropylamidocyanidophosphate

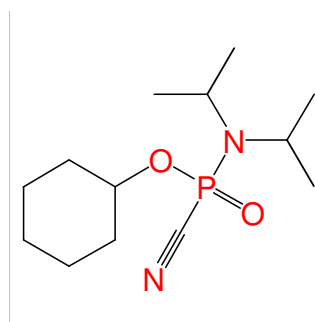

**Chemical name:** Cyclohexyl N-methyl-N-propylphosphoramidocyanidate

Schedule: 1A02

CAS RN:

HS code: 2931.39

Key: (108-93-0)-1A2-MP

Molecular formula: C<sub>11</sub>H<sub>21</sub>N<sub>2</sub>O<sub>2</sub>P

CAS Index Name:

**IUPAC name:**

Synonyms:

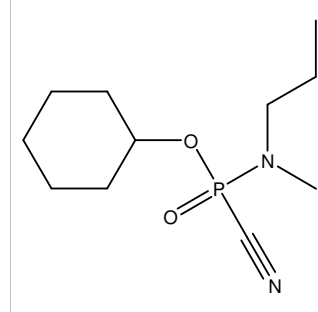

**Chemical name:** Hexyl N,N-diethylphosphoramidocyanidate

Schedule: 1A02

CAS RN:

HS code: 2931.39

Key: (111-27-3)-1A2-EE

Molecular formula: C<sub>11</sub>H<sub>23</sub>N<sub>2</sub>O<sub>2</sub>P

CAS Index Name:

**IUPAC name:**

Synonyms:

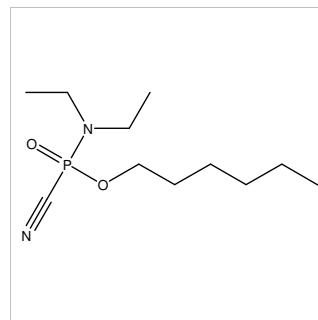

**Chemical name:** Heptyl N-ethyl-N-isopropylphosphoramidocyanidate

Schedule: 1A02

CAS RN:

HS code: 2931.39

Key: (111-70-6)-1A2-EI

Molecular formula: C<sub>13</sub>H<sub>27</sub>N<sub>2</sub>O<sub>2</sub>P

CAS Index Name:

**IUPAC name:**

Synonyms:

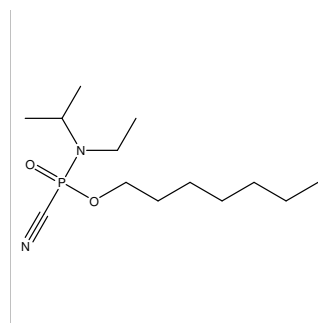

**Chemical name:** Heptyl N-ethyl-N-methylphosphoramidocyanidate

Schedule: 1A02

CAS RN:

HS code: 2931.39

Key: (111-70-6)-1A2-EM

Molecular formula: C<sub>11</sub>H<sub>23</sub>N<sub>2</sub>O<sub>2</sub>P

CAS Index Name:

**IUPAC name:**

Synonyms:

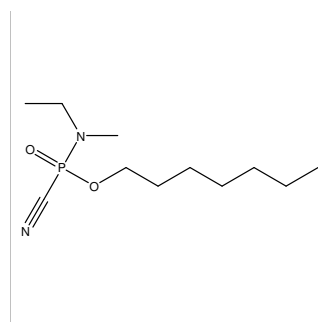



**Chemical name:** Heptyl N-ethyl-N-propylphosphoramidocyanidate

Schedule: 1A02

CAS RN: HS code: 2931.39

Key: (111-70-6)-1A2-EP

Molecular formula: C<sub>13</sub>H<sub>27</sub>N<sub>2</sub>O<sub>2</sub>P

CAS Index Name:

**IUPAC name:**

Synonyms:

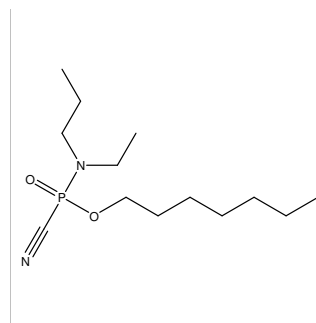

**Chemical name:** Heptyl N-isopropyl-N-methylphosphoramidocyanidate

Schedule: 1A02

CAS RN: HS code: 2931.39

Key: (111-70-6)-1A2-IM

Molecular formula: C<sub>12</sub>H<sub>25</sub>N<sub>2</sub>O<sub>2</sub>P

CAS Index Name: Phosphoramidocyanidic acid, (1-methylethyl)methyl-, heptyl ester

**IUPAC name:** Heptyl isopropylmethylphosphoramidocyanidoate

Synonyms: O-Heptyl N-isopropyl-N-methylphosphoramidocyanidate

n-Heptyl N-isopropyl-N-methylphosphoramidocyanidate

Heptyl isopropyl(methyl)amidocyanidophosphate

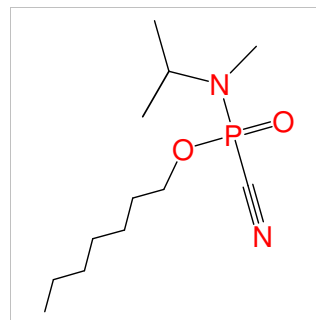

**Chemical name:** Heptyl N-methyl-N-propylphosphoramidocyanidate

Schedule: 1A02

CAS RN: HS code: 2931.39

Key: (111-70-6)-1A2-MP

Molecular formula: C<sub>12</sub>H<sub>25</sub>N<sub>2</sub>O<sub>2</sub>P

CAS Index Name:

**IUPAC name:**

Synonyms:

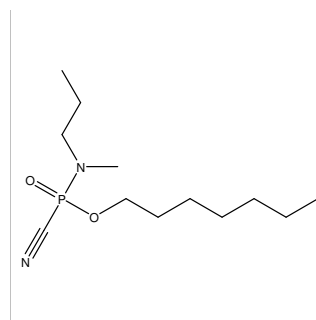

**Chemical name:** Octyl N-ethyl-N-isopropylphosphoramidocyanidate

Schedule: 1A02

CAS RN: HS code: 2931.39

Key: (111-87-5)-1A2-EI

Molecular formula: C<sub>14</sub>H<sub>29</sub>N<sub>2</sub>O<sub>2</sub>P

CAS Index Name:

**IUPAC name:**

Synonyms:

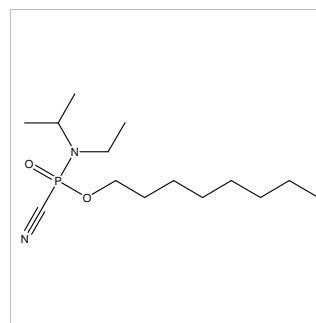

**Chemical name:** Octyl N-ethyl-N-methylphosphoramidocyanidate

Schedule: 1A02

CAS RN: HS code: 2931.39

Key: (111-87-5)-1A2-EM

Molecular formula: C<sub>12</sub>H<sub>25</sub>N<sub>2</sub>O<sub>2</sub>P

CAS Index Name:

**IUPAC name:**

Synonyms:

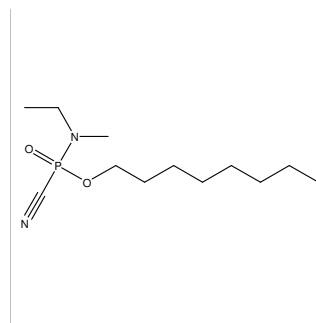

**Chemical name:** Octyl N-ethyl-N-propylphosphoramidocyanidate

Schedule: 1A02

CAS RN: HS code: 2931.39

Key: (111-87-5)-1A2-EP

Molecular formula: C<sub>14</sub>H<sub>29</sub>N<sub>2</sub>O<sub>2</sub>P

CAS Index Name:

**IUPAC name:**

Synonyms:

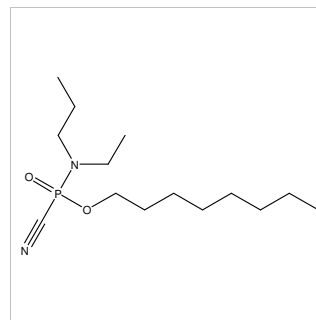

**Chemical name:** Octyl N-isopropyl-N-methylphosphoramidocyanidate

Schedule: 1A02

CAS RN: HS code: 2931.39

Key: (111-87-5)-1A2-IM

Molecular formula: C<sub>13</sub>H<sub>27</sub>N<sub>2</sub>O<sub>2</sub>P

CAS Index Name:

**IUPAC name:**

Synonyms:

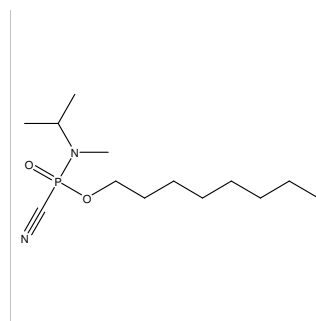

**Chemical name:** Octyl N-methyl-N-propylphosphoramidocyanidate

Schedule: 1A02

CAS RN: HS code: 2931.39

Key: (111-87-5)-1A2-MP

Molecular formula: C<sub>13</sub>H<sub>27</sub>N<sub>2</sub>O<sub>2</sub>P

CAS Index Name: Phosphoramidocyanidic acid, methylpropyl-, octyl ester

**IUPAC name:** Octyl methylpropylphosphoramidocyanidoate

Synonyms: Octyl methylpropylamidocyanidophosphate

Octyl methyl(propyl)amidocyanidophosphate

O-Octyl N-methyl-N-propylphosphoramidocyanidate

n-Octyl N-methyl-N-propylphosphoramidocyanidate

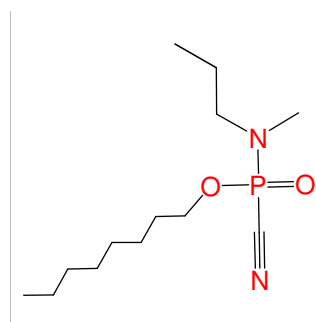

**Chemical name:** 1-Methylnonyl N,N-dimethylphosphoramidocyanidate

Schedule: 1A02

CAS RN: HS code: 2931.39

Key: (1120-06-5)-1A2-MM

Molecular formula: C<sub>13</sub>H<sub>27</sub>N<sub>2</sub>O<sub>2</sub>P

CAS Index Name:

**IUPAC name:**

Synonyms:

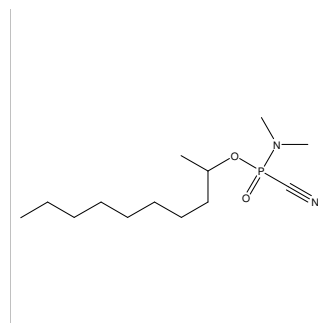

**Chemical name:** Decyl N,N-diethylphosphoramidocyanidate

Schedule: 1A02

CAS RN: HS code: 2931.39

Key: (112-30-1)-1A2-EE

Molecular formula: C<sub>15</sub>H<sub>31</sub>N<sub>2</sub>O<sub>2</sub>P

CAS Index Name:

**IUPAC name:**

Synonyms:

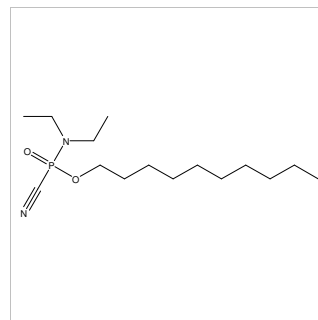

**Chemical name:** Decyl N-ethyl-N-isopropylphosphoramidocyanidate

Schedule: 1A02

CAS RN: HS code: 2931.39

Key: (112-30-1)-1A2-EI

Molecular formula: C<sub>16</sub>H<sub>33</sub>N<sub>2</sub>O<sub>2</sub>P

CAS Index Name:

**IUPAC name:**

Synonyms:

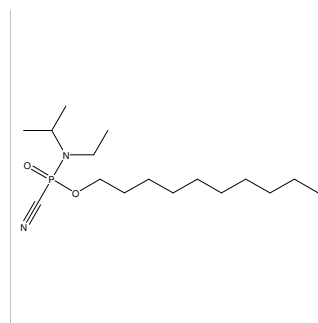

**Chemical name:** Decyl N-ethyl-N-methylphosphoramidocyanidate

Schedule: 1A02

CAS RN: HS code: 2931.39

Key: (112-30-1)-1A2-EM

Molecular formula: C<sub>14</sub>H<sub>29</sub>N<sub>2</sub>O<sub>2</sub>P

CAS Index Name:

**IUPAC name:**

Synonyms:

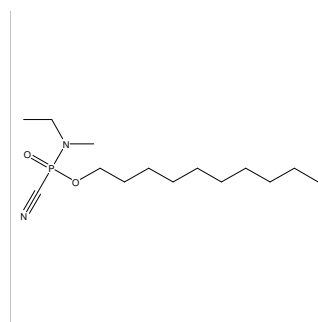

**Chemical name:** Decyl N-ethyl-N-propylphosphoramidocyanidate

Schedule: 1A02

CAS RN: HS code: 2931.39

Key: (112-30-1)-1A2-EP

Molecular formula: C<sub>16</sub>H<sub>33</sub>N<sub>2</sub>O<sub>2</sub>P

CAS Index Name:

**IUPAC name:**

Synonyms:

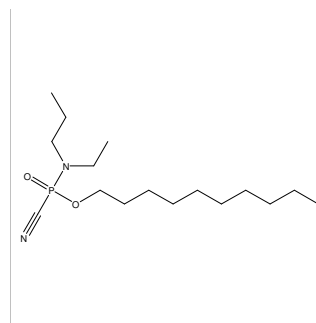

**Chemical name:** Decyl N-isopropyl-N-methylphosphoramidocyanidate

Schedule: 1A02

CAS RN: HS code: 2931.39

Key: (112-30-1)-1A2-IM

Molecular formula: C<sub>15</sub>H<sub>31</sub>N<sub>2</sub>O<sub>2</sub>P

CAS Index Name:

**IUPAC name:**

Synonyms:

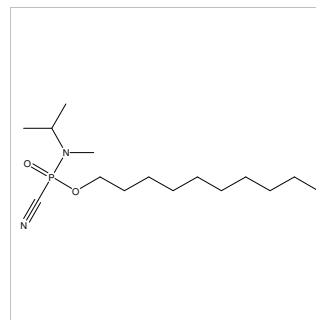

**Chemical name:** Decyl N,N-dimethylphosphoramidocyanidate

Schedule: 1A02

CAS RN: HS code: 2931.39

Key: (112-30-1)-1A2-MM

Molecular formula: C<sub>13</sub>H<sub>27</sub>N<sub>2</sub>O<sub>2</sub>P

CAS Index Name: Phosphoramidocyanidic acid, dimethyl-, decyl ester

**IUPAC name:** Decyl dimethylphosphoramidocyanidoate

Synonyms: O-Decyl N,N-dimethylphosphoramidocyanidate

n-Decyl N,N-dimethylphosphoramidocyanidate

Decyl dimethylamidocyanidophosphate

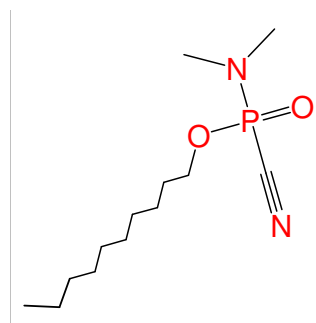

**Chemical name:** Decyl N-methyl-N-propylphosphoramidocyanidate

Schedule: 1A02

CAS RN: HS code: 2931.39

Key: (112-30-1)-1A2-MP

Molecular formula: C<sub>15</sub>H<sub>31</sub>N<sub>2</sub>O<sub>2</sub>P

CAS Index Name: Phosphoramidocyanidic acid, methylpropyl-, decyl ester

**IUPAC name:** Decyl methylpropylphosphoramidocyanidoate

Synonyms: O-Decyl N-methyl-N-propylphosphoramidocyanidate

n-Decyl N-methyl-N-propylphosphoramidocyanidate

Decyl methylpropylamidocyanidophosphate

Decyl methyl(propyl)amidocyanidophosphate

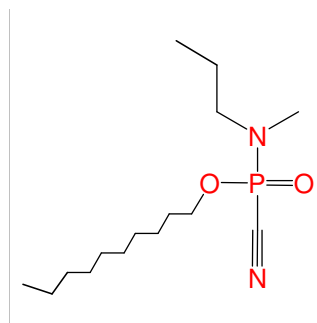

**Chemical name:** Decyl N,N-dipropylphosphoramidocyanidate

Schedule: 1A02

CAS RN: HS code: 2931.39

Key: (112-30-1)-1A2-PP

Molecular formula: C<sub>17</sub>H<sub>35</sub>N<sub>2</sub>O<sub>2</sub>P

CAS Index Name:

**IUPAC name:**

Synonyms:

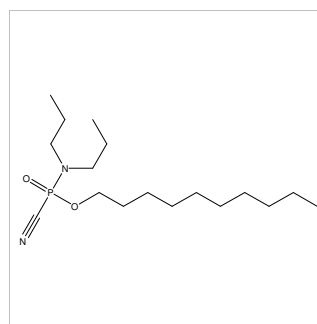

**Chemical name:** 3-Cyclohexylpropyl N,N-dimethylphosphoramidocyanidate

Schedule: 1A02

CAS RN: HS code: 2931.39

Key: (1124-63-6)-1A2-MM

Molecular formula: C<sub>12</sub>H<sub>23</sub>N<sub>2</sub>O<sub>2</sub>P

CAS Index Name:

**IUPAC name:**

Synonyms:

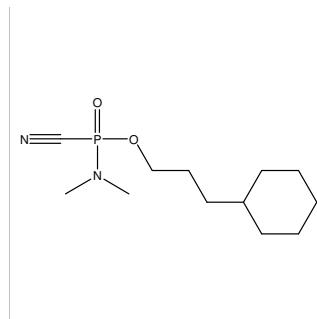

**Chemical name:** 1-Cyclohexylethyl N,N-dimethylphosphoramidocyanidate

Schedule: 1A02

CAS RN: HS code: 2931.39

Key: (1193-81-3)-1A2-MM

Molecular formula: C<sub>11</sub>H<sub>21</sub>N<sub>2</sub>O<sub>2</sub>P

CAS Index Name:

**IUPAC name:**

Synonyms:

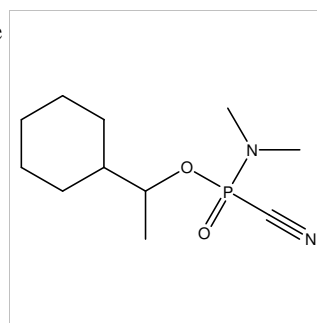

**Chemical name:** 3-Methylbutyl N,N-diethylphosphoramidocyanidate

Schedule: 1A02

CAS RN:

HS code: 2931.39

Key: (123-51-3)-1A2-EE

Molecular formula: C<sub>10</sub>H<sub>21</sub>N<sub>2</sub>O<sub>2</sub>P

CAS Index Name:

**IUPAC name:**

Synonyms:

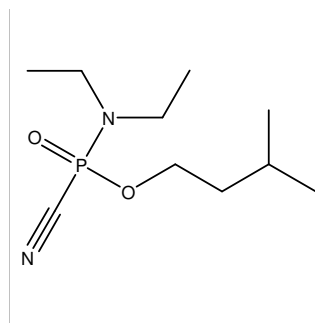

**Chemical name:** 3-Methylbutyl N,N-diisopropylphosphoramidocyanidate

Schedule: 1A02

CAS RN:

HS code: 2931.39

Key: (123-51-3)-1A2-II

Molecular formula: C<sub>12</sub>H<sub>25</sub>N<sub>2</sub>O<sub>2</sub>P

CAS Index Name:

**IUPAC name:**

Synonyms:

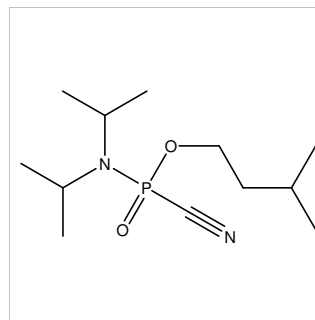

**Chemical name:** 3-Methylbutyl N,N-dimethylphosphoramidocyanidate

Schedule: 1A02

CAS RN:

HS code: 2931.39

Key: (123-51-3)-1A2-MM

Molecular formula: C<sub>8</sub>H<sub>17</sub>N<sub>2</sub>O<sub>2</sub>P

CAS Index Name:

**IUPAC name:**

Synonyms:

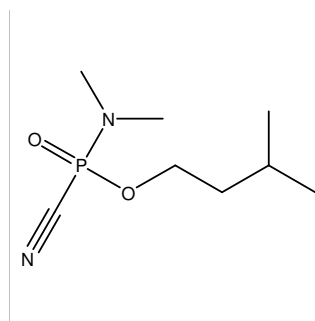

**Chemical name:** 3-Methylbutyl N,N-dipropylphosphoramidocyanidate

Schedule: 1A02

CAS RN:

HS code: 2931.39

Key: (123-51-3)-1A2-PP

Molecular formula: C<sub>12</sub>H<sub>25</sub>N<sub>2</sub>O<sub>2</sub>P

CAS Index Name:

**IUPAC name:**

Synonyms:

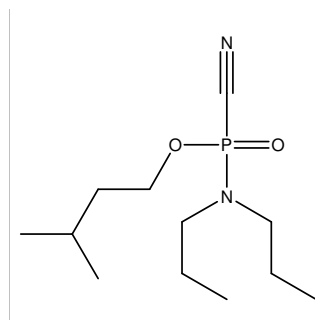

**Chemical name:** 1-Methylheptyl N,N-dimethylphosphoramidocyanidate

Schedule: 1A02

CAS RN:

HS code: 2931.39

Key: (123-96-6)-1A2-MM

Molecular formula: C<sub>11</sub>H<sub>23</sub>N<sub>2</sub>O<sub>2</sub>P

CAS Index Name:

**IUPAC name:**

Synonyms:

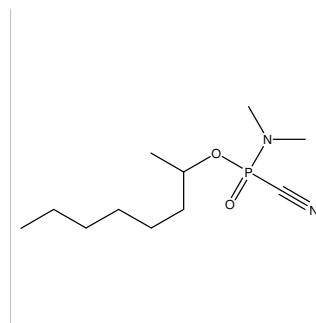

**Chemical name:** 2-Methylbutyl N,N-diethylphosphoramidocyanidate

Schedule: 1A02

CAS RN:

HS code: 2931.39

Key: (137-32-6)-1A2-EE

Molecular formula: C<sub>10</sub>H<sub>21</sub>N<sub>2</sub>O<sub>2</sub>P

CAS Index Name:

**IUPAC name:**

Synonyms:

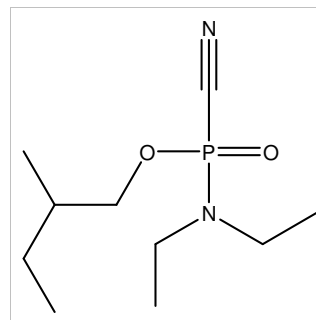

**Chemical name:** 2-Methylbutyl N,N-diisopropylphosphoramidocyanidate

Schedule: 1A02

CAS RN:

HS code: 2931.39

Key: (137-32-6)-1A2-II

Molecular formula: C<sub>12</sub>H<sub>25</sub>N<sub>2</sub>O<sub>2</sub>P

CAS Index Name:

**IUPAC name:**

Synonyms:

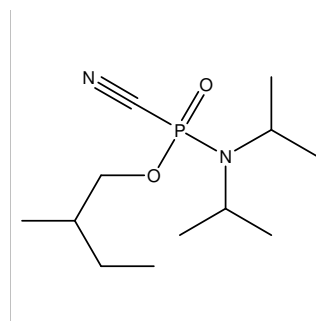

**Chemical name:** 2-Methylbutyl N,N-dimethylphosphoramidocyanidate

Schedule: 1A02

CAS RN:

HS code: 2931.39

Key: (137-32-6)-1A2-MM

Molecular formula: C<sub>8</sub>H<sub>17</sub>N<sub>2</sub>O<sub>2</sub>P

CAS Index Name:

**IUPAC name:**

Synonyms:

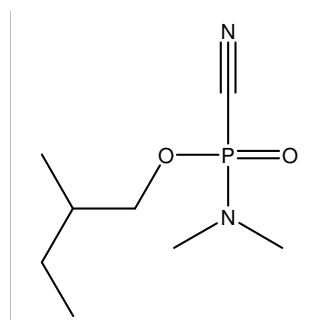

**Chemical name:** 2-Methylbutyl N,N-dipropylphosphoramidocyanidate

Schedule: 1A02

CAS RN:

HS code: 2931.39

Key: (137-32-6)-1A2-PP

Molecular formula: C<sub>12</sub>H<sub>25</sub>N<sub>2</sub>O<sub>2</sub>P

CAS Index Name:

**IUPAC name:**

Synonyms:

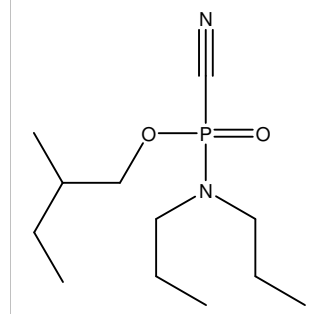

**Chemical name:** Nonyl N,N-diethylphosphoramidocyanidate

Schedule: 1A02

CAS RN:

HS code: 2931.39

Key: (143-08-8)-1A2-EE

Molecular formula: C<sub>14</sub>H<sub>29</sub>N<sub>2</sub>O<sub>2</sub>P

CAS Index Name:

**IUPAC name:**

Synonyms:

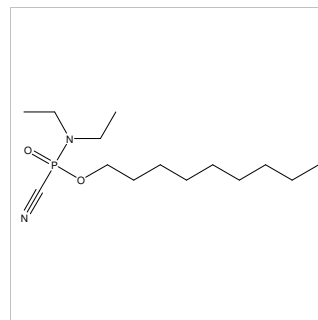

**Chemical name:** Nonyl N-ethyl-N-isopropylphosphoramidocyanidate

Schedule: 1A02

CAS RN:

HS code: 2931.39

Key: (143-08-8)-1A2-EI

Molecular formula: C<sub>15</sub>H<sub>31</sub>N<sub>2</sub>O<sub>2</sub>P

CAS Index Name:

**IUPAC name:**

Synonyms:

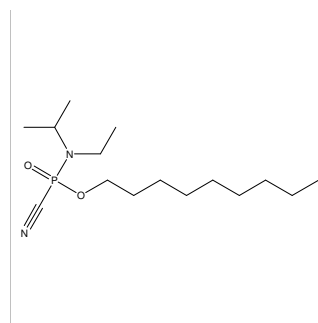

**Chemical name:** Nonyl N-ethyl-N-methylphosphoramidocyanidate

Schedule: 1A02

CAS RN:

HS code: 2931.39

Key: (143-08-8)-1A2-EM

Molecular formula: C<sub>13</sub>H<sub>27</sub>N<sub>2</sub>O<sub>2</sub>P

CAS Index Name:

**IUPAC name:**

Synonyms:

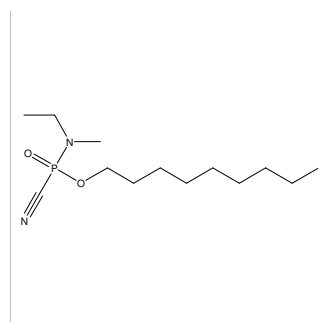



**Chemical name:** Nonyl N-ethyl-N-propylphosphoramidocyanidate

Schedule: 1A02

CAS RN: HS code: 2931.39

Key: (143-08-8)-1A2-EP

Molecular formula: C<sub>15</sub>H<sub>31</sub>N<sub>2</sub>O<sub>2</sub>P

CAS Index Name:

**IUPAC name:**

Synonyms:

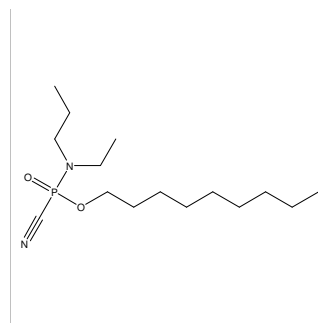

**Chemical name:** Nonyl N,N-diisopropylphosphoramidocyanidate

Schedule: 1A02

CAS RN: HS code: 2931.39

Key: (143-08-8)-1A2-II

Molecular formula: C<sub>16</sub>H<sub>33</sub>N<sub>2</sub>O<sub>2</sub>P

CAS Index Name:

**IUPAC name:**

Synonyms:

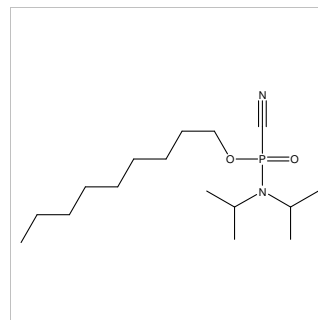

**Chemical name:** Nonyl N,N-dimethylphosphoramidocyanidate

Schedule: 1A02

CAS RN: HS code: 2931.39

Key: (143-08-8)-1A2-MM

Molecular formula: C<sub>12</sub>H<sub>25</sub>N<sub>2</sub>O<sub>2</sub>P

CAS Index Name: Phosphoramidocyanidic acid, dimethyl-, nonyl ester

**IUPAC name:** Nonyl dimethylphosphoramidocyanidoate

Synonyms: O-Nonyl N,N-dimethylphosphoramidocyanidate

Nonyl dimethylamidocyanidophosphate

n-Nonyl N,N-dimethylphosphoramidocyanidate

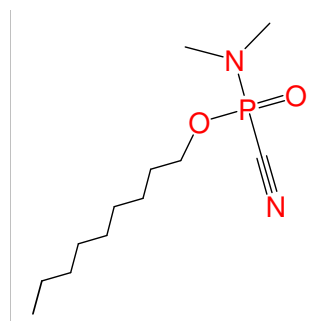

**Chemical name:** Nonyl N-methyl-N-propylphosphoramidocyanidate

Schedule: 1A02

CAS RN: HS code: 2931.39

Key: (143-08-8)-1A2-MP

Molecular formula: C<sub>14</sub>H<sub>29</sub>N<sub>2</sub>O<sub>2</sub>P

CAS Index Name: Phosphoramidocyanidic acid, methylpropyl-, nonyl ester

**IUPAC name:** Nonyl methylpropylphosphoramidocyanidoate

Synonyms: O-Nonyl N-methyl-N-propylphosphoramidocyanidate

Nonyl methylpropylamidocyanidophosphate

Nonyl methyl(propyl)amidocyanidophosphate

n-Nonyl N-methyl-N-propylphosphoramidocyanidate

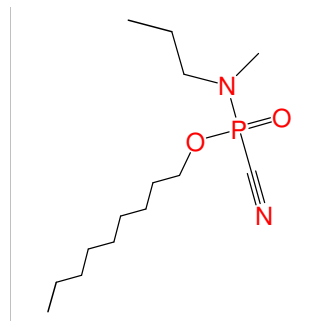

**Chemical name:** Nonyl N,N-dipropylphosphoramidocyanidate

Schedule: 1A02

CAS RN: HS code: 2931.39

Key: (143-08-8)-1A2-PP

Molecular formula: C<sub>16</sub>H<sub>33</sub>N<sub>2</sub>O<sub>2</sub>P

CAS Index Name:

**IUPAC name:**

Synonyms:

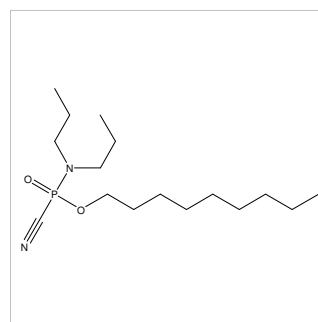

**Chemical name:** 1-Ethyl-2-methylpentyl N,N-dimethylphosphoramidocyanidate

Schedule: 1A02

CAS RN: HS code: 2931.39

Key: (14979-39-6)-1A2-MM

Molecular formula: C<sub>11</sub>H<sub>23</sub>N<sub>2</sub>O<sub>2</sub>P

CAS Index Name:

**IUPAC name:**

Synonyms:

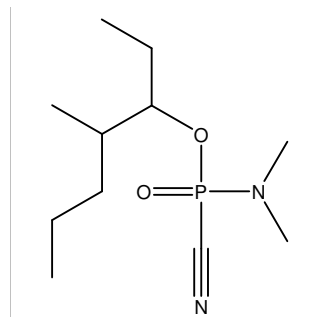

**Chemical name:** 2,3-Dimethylcyclohexyl N,N-dimethylphosphoramidocyanidate

Schedule: 1A02

CAS RN: HS code: 2931.39

Key: (1502-24-5)-1A2-MM

Molecular formula: C<sub>11</sub>H<sub>21</sub>N<sub>2</sub>O<sub>2</sub>P

CAS Index Name:

**IUPAC name:**

Synonyms:

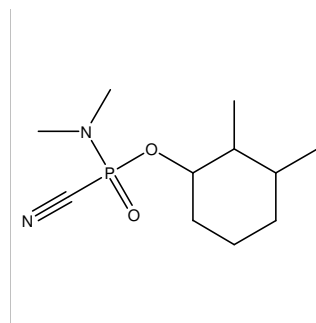

**Chemical name:** Ethyl-d<sub>5</sub> N,N-dimethylphosphoramidocyanidate

Schedule: 1A02

CAS RN: HS code: 2845.90

Key: (1516-08-1)-1A2-MM

Molecular formula: C<sub>5</sub>H<sub>6</sub>D<sub>5</sub>N<sub>2</sub>O<sub>2</sub>P

CAS Index Name: Phosphoramidocyanidic acid, dimethyl-, ethyl-d<sub>5</sub> ester

**IUPAC name:** Ethyl-d<sub>5</sub> dimethylphosphoramidocyanidoate

Synonyms: Pentadeuterioethyl N,N-dimethylphosphoramidocyanidate

O-Ethyl-d<sub>5</sub> N,N-dimethylphosphoramidocyanidate

Ethyl-d<sub>5</sub> dimethylamidocyanidophosphate

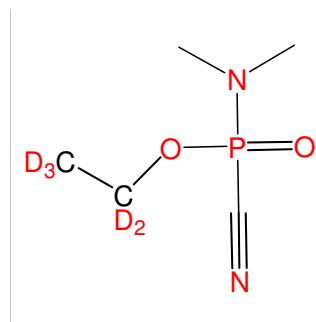

**Chemical name:** 2,4,4-Trimethylpentyl N,N-dimethylphosphoramidocyanidate

Schedule: 1A02

CAS RN: HS code: 2931.39

Key: (16325-63-6)-1A2-MM

Molecular formula: C<sub>11</sub>H<sub>23</sub>N<sub>2</sub>O<sub>2</sub>P

CAS Index Name:

**IUPAC name:**

Synonyms:

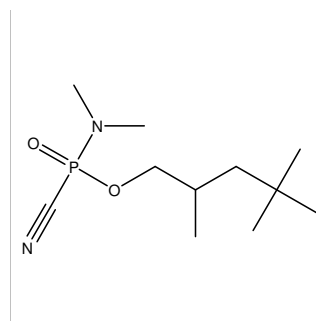

**Chemical name:** 3-Methylcyclopentyl N,N-diethylphosphoramidocyanidate

Schedule: 1A02

CAS RN: HS code: 2931.39

Key: (18729-48-1)-1A2-EE

Molecular formula: C<sub>11</sub>H<sub>21</sub>N<sub>2</sub>O<sub>2</sub>P

CAS Index Name:

**IUPAC name:**

Synonyms:

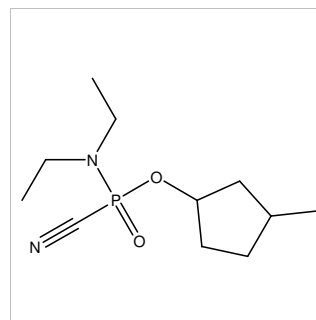

**Chemical name:** 3-Methylcyclopentyl N-ethyl-N-isopropylphosphoramidocyanidate

Schedule: 1A02

CAS RN: HS code: 2931.39

Key: (18729-48-1)-1A2-EI

Molecular formula: C<sub>12</sub>H<sub>23</sub>N<sub>2</sub>O<sub>2</sub>P

CAS Index Name:

**IUPAC name:**

Synonyms:

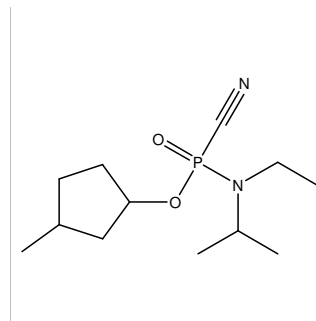

**Chemical name:** 3-Methylcyclopentyl N-ethyl-N-methylphosphoramidocyanidate

Schedule: 1A02

CAS RN: HS code: 2931.39

Key: (18729-48-1)-1A2-EM

Molecular formula: C<sub>10</sub>H<sub>19</sub>N<sub>2</sub>O<sub>2</sub>P

CAS Index Name:

**IUPAC name:**

Synonyms:

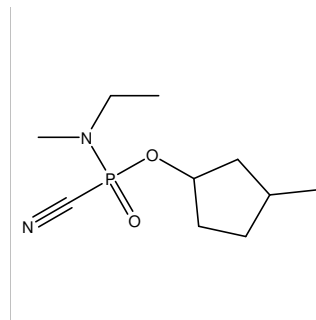

**Chemical name:** 3-Methylcyclopentyl N-ethyl-N-propylphosphoramidocyanidate

Schedule: 1A02

CAS RN: HS code: 2931.39

Key: (18729-48-1)-1A2-EP

Molecular formula: C<sub>12</sub>H<sub>23</sub>N<sub>2</sub>O<sub>2</sub>P

CAS Index Name:

**IUPAC name:**

Synonyms:

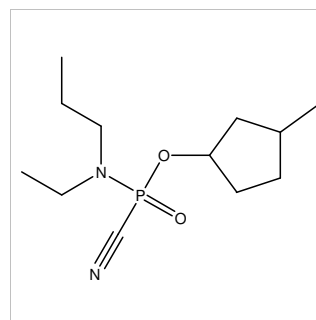

**Chemical name:** 3-Methylcyclopentyl N,N-diisopropylphosphoramidocyanidate

Schedule: 1A02

CAS RN: HS code: 2931.39

Key: (18729-48-1)-1A2-II

Molecular formula: C<sub>13</sub>H<sub>25</sub>N<sub>2</sub>O<sub>2</sub>P

CAS Index Name:

**IUPAC name:**

Synonyms:

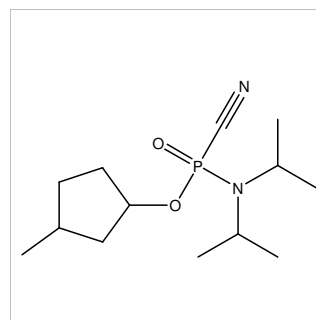

**Chemical name:** 3-Methylcyclopentyl N-isopropyl-N-methylphosphoramidocyanidate

Schedule: 1A02

CAS RN: HS code: 2931.39

Key: (18729-48-1)-1A2-IM

Molecular formula: C<sub>11</sub>H<sub>21</sub>N<sub>2</sub>O<sub>2</sub>P

CAS Index Name:

**IUPAC name:**

Synonyms:

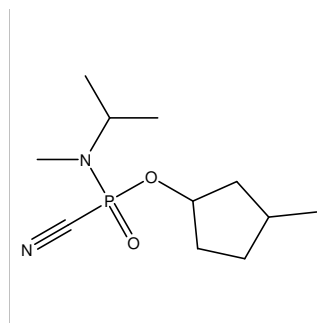

**Chemical name:** 3-Methylcyclopentyl N,N-dimethylphosphoramidocyanidate

Schedule: 1A02

CAS RN: HS code: 2931.39

Key: (18729-48-1)-1A2-MM

Molecular formula: C<sub>9</sub>H<sub>17</sub>N<sub>2</sub>O<sub>2</sub>P

CAS Index Name:

**IUPAC name:**

Synonyms:

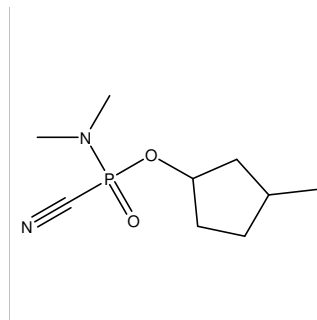

**Chemical name:** 3-Methylcyclopentyl N-methyl-N-propylphosphoramidocyanidate

Schedule: 1A02

CAS RN: HS code: 2931.39

Key: (18729-48-1)-1A2-MP

Molecular formula: C<sub>11</sub>H<sub>21</sub>N<sub>2</sub>O<sub>2</sub>P

CAS Index Name:

**IUPAC name:**

Synonyms:

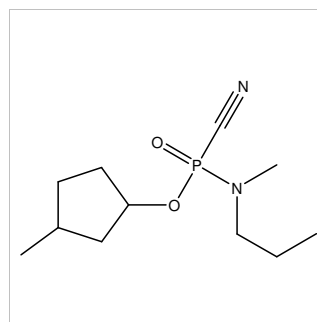

**Chemical name:** 3-Methylcyclopentyl N,N-dipropylphosphoramidocyanidate

Schedule: 1A02

CAS RN: HS code: 2931.39

Key: (18729-48-1)-1A2-PP

Molecular formula: C<sub>13</sub>H<sub>25</sub>N<sub>2</sub>O<sub>2</sub>P

CAS Index Name:

**IUPAC name:**

Synonyms:

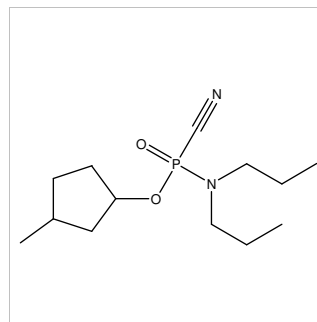

**Chemical name:** 1-Propylheptyl N,N-dimethylphosphoramidocyanidate

Schedule: 1A02

CAS RN: HS code: 2931.39

Key: (2051-31-2)-1A2-MM

Molecular formula: C<sub>13</sub>H<sub>27</sub>N<sub>2</sub>O<sub>2</sub>P

CAS Index Name:

**IUPAC name:**

Synonyms:

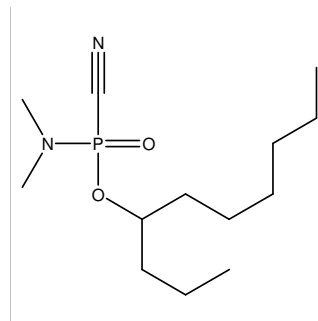

**Chemical name:** 2-Methylcyclopentyl N,N-dimethylphosphoramidocyanidate

Schedule: 1A02

CAS RN: HS code: 2931.39

Key: (24070-77-7)-1A2-MM

Molecular formula: C<sub>9</sub>H<sub>17</sub>N<sub>2</sub>O<sub>2</sub>P

CAS Index Name:

**IUPAC name:**

Synonyms:

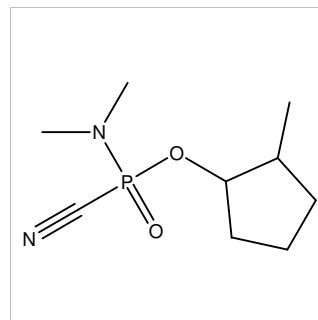

**Chemical name:** 3,3,5,5-Tetramethylcyclohexyl N,N-dimethylphosphoramidocyanidate

Schedule: 1A02

CAS RN: HS code: 2931.39

Key: (2650-40-4)-1A2-MM

Molecular formula: C<sub>13</sub>H<sub>25</sub>N<sub>2</sub>O<sub>2</sub>P

CAS Index Name:

**IUPAC name:**

Synonyms:

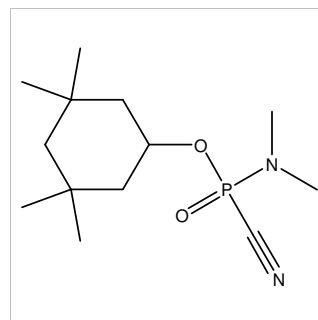

**Chemical name:** 3,5,5-Trimethylhexyl N,N-dimethylphosphoramidocyanidate

Schedule: 1A02

CAS RN: HS code: 2931.39

Key: (3452-97-9)-1A2-MM

Molecular formula: C<sub>12</sub>H<sub>25</sub>N<sub>2</sub>O<sub>2</sub>P

CAS Index Name:

**IUPAC name:**

Synonyms:

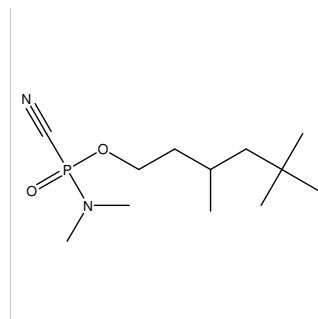

**Chemical name:** Cyclopentylmethyl N,N-diethylphosphoramidocyanidate

Schedule: 1A02

CAS RN:

HS code: 2931.39

Key: (3637-61-4)-1A2-EE

Molecular formula: C<sub>11</sub>H<sub>21</sub>N<sub>2</sub>O<sub>2</sub>P

CAS Index Name:

**IUPAC name:**

Synonyms:

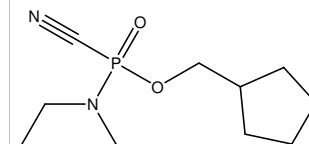

**Chemical name:** Cyclopentylmethyl N,N-diisopropylphosphoramidocyanidate

Schedule: 1A02

CAS RN:

HS code: 2931.39

Key: (3637-61-4)-1A2-II

Molecular formula: C<sub>13</sub>H<sub>25</sub>N<sub>2</sub>O<sub>2</sub>P

CAS Index Name:

**IUPAC name:**

Synonyms:

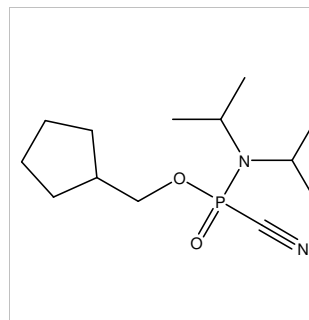

**Chemical name:** Cyclopentylmethyl N,N-dimethylphosphoramidocyanidate

Schedule: 1A02

CAS RN:

HS code: 2931.39

Key: (3637-61-4)-1A2-MM

Molecular formula: C<sub>9</sub>H<sub>17</sub>N<sub>2</sub>O<sub>2</sub>P

CAS Index Name:

**IUPAC name:**

Synonyms:

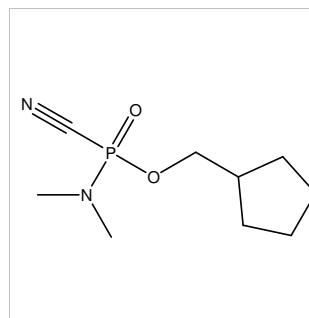

**Chemical name:** Cyclopentylmethyl N,N-dipropylphosphoramidocyanidate

Schedule: 1A02

CAS RN:

HS code: 2931.39

Key: (3637-61-4)-1A2-PP

Molecular formula: C<sub>13</sub>H<sub>25</sub>N<sub>2</sub>O<sub>2</sub>P

CAS Index Name:

**IUPAC name:**

Synonyms:

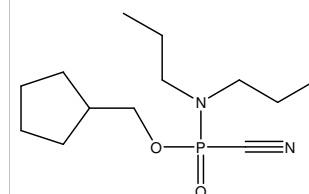

**Chemical name:** 2-Ethylcyclohexyl N,N-diethylphosphoramidocyanidate

Schedule: 1A02

CAS RN:

HS code: 2931.39

Key: (3760-20-1)-1A2-EE

Molecular formula: C<sub>13</sub>H<sub>25</sub>N<sub>2</sub>O<sub>2</sub>P

CAS Index Name:

**IUPAC name:**

Synonyms:

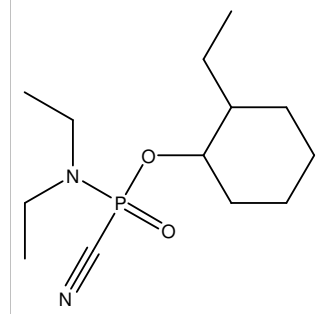

**Chemical name:** 2-Ethylcyclohexyl N,N-diisopropylphosphoramidocyanidate

Schedule: 1A02

CAS RN:

HS code: 2931.39

Key: (3760-20-1)-1A2-II

Molecular formula: C<sub>15</sub>H<sub>29</sub>N<sub>2</sub>O<sub>2</sub>P

CAS Index Name:

**IUPAC name:**

Synonyms:

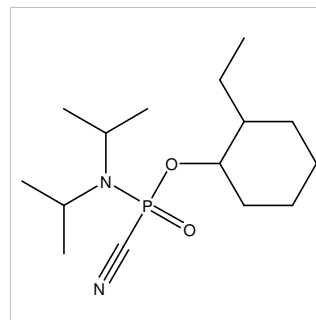

**Chemical name:** 2-Ethylcyclohexyl N,N-dimethylphosphoramidocyanidate

Schedule: 1A02

CAS RN:

HS code: 2931.39

Key: (3760-20-1)-1A2-MM

Molecular formula: C<sub>11</sub>H<sub>21</sub>N<sub>2</sub>O<sub>2</sub>P

CAS Index Name:

**IUPAC name:**

Synonyms:

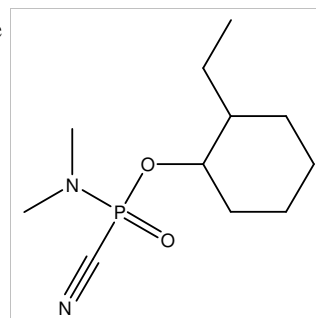

**Chemical name:** 2-Ethylcyclohexyl N,N-dipropylphosphoramidocyanidate

Schedule: 1A02

CAS RN:

HS code: 2931.39

Key: (3760-20-1)-1A2-PP

Molecular formula: C<sub>15</sub>H<sub>29</sub>N<sub>2</sub>O<sub>2</sub>P

CAS Index Name:

**IUPAC name:**

Synonyms:

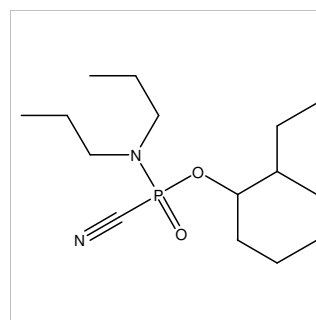



**Chemical name:** 1-Ethyl-2,2-dimethylpropyl N,N-dimethylphosphoramidocyanidate

Schedule: 1A02

CAS RN: HS code: 2931.39

Key: (3970-62-5)-1A2-MM

Molecular formula: C<sub>10</sub>H<sub>21</sub>N<sub>2</sub>O<sub>2</sub>P

CAS Index Name:

**IUPAC name:**

Synonyms:

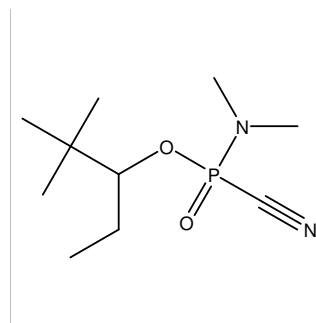

**Chemical name:** 4-Cyclohexylbutyl N,N-dimethylphosphoramidocyanidate

Schedule: 1A02

CAS RN: HS code: 2931.39

Key: (4441-57-0)-1A2-MM

Molecular formula: C<sub>13</sub>H<sub>25</sub>N<sub>2</sub>O<sub>2</sub>P

CAS Index Name:

**IUPAC name:**

Synonyms:

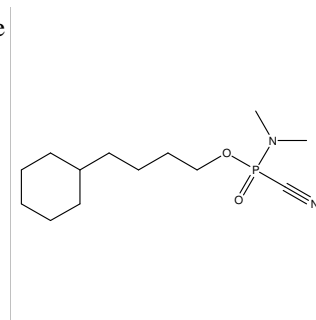

**Chemical name:** 2-Cyclohexylethyl N,N-diethylphosphoramidocyanidate

Schedule: 1A02

CAS RN: HS code: 2931.39

Key: (4442-79-9)-1A2-EE

Molecular formula: C<sub>13</sub>H<sub>25</sub>N<sub>2</sub>O<sub>2</sub>P

CAS Index Name: Phosphoramidocyanidic acid, diethyl-, 2-cyclohexylethyl ester

**IUPAC name:** 2-Cyclohexylethyl diethylphosphoramidocyanidoate

Synonyms: O-2-Cyclohexylethyl N,N-diethylphosphoramidocyanidate  
2-Cyclohexylethyl diethylamidocyanidophosphate

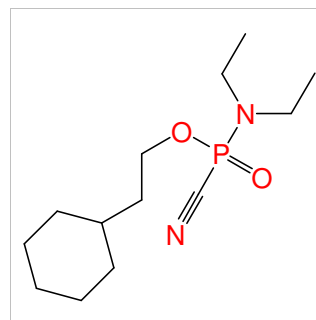

**Chemical name:** 2-Cyclohexylethyl N,N-dimethylphosphoramidocyanidate

Schedule: 1A02

CAS RN: HS code: 2931.39

Key: (4442-79-9)-1A2-MM

Molecular formula: C<sub>11</sub>H<sub>21</sub>N<sub>2</sub>O<sub>2</sub>P

CAS Index Name:

**IUPAC name:**

Synonyms:

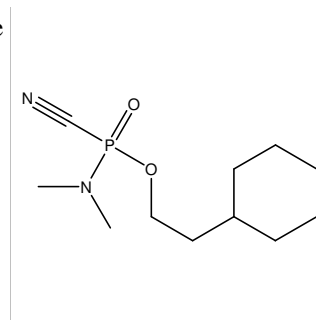

**Chemical name:** 4-Ethylcyclohexyl N,N-dimethylphosphoramidocyanidate

Schedule: 1A02

CAS RN: HS code: 2931.39

Key: (4534-74-1)-1A2-MM

Molecular formula: C<sub>11</sub>H<sub>21</sub>N<sub>2</sub>O<sub>2</sub>P

CAS Index Name:

**IUPAC name:**

Synonyms:

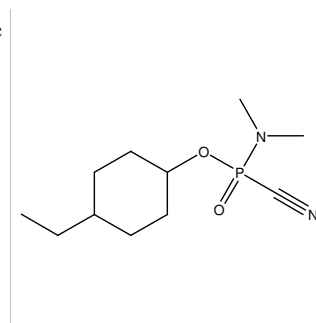

**Chemical name:** Pinacolyl N,N-diethylphosphoramidocyanidate

Schedule: 1A02

CAS RN: HS code: 2931.39

Key: (464-07-3)-1A2-EE

Molecular formula: C<sub>11</sub>H<sub>23</sub>N<sub>2</sub>O<sub>2</sub>P

CAS Index Name: Phosphoramidocyanidic acid, diethyl-, 1,2,2-trimethylpropyl ester

**IUPAC name:** 1,2,2-Trimethylpropyl diethylphosphoramidocyanidoate

Synonyms: Phosphoramidocyanidic acid, N,N-diethyl-, 1,2,2-trimethylpropyl ester

O-Pinacolyl N,N-diethylphosphoramidocyanidate

O-1,2,2-Trimethylpropyl N,N-diethylphosphoramidocyanidate

3,3-Dimethylbutan-2-yl N,N-diethylphosphoramidocyanidate

3,3-Dimethylbut-2-yl N,N-diethylphosphoramidocyanidate

1,2,2-Trimethylpropyl diethylamidocyanidophosphate

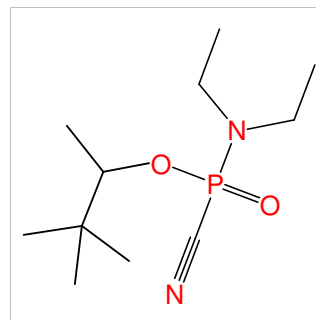

**Chemical name:** Pinacolyl N-ethyl-N-isopropylphosphoramidocyanidate

Schedule: 1A02

CAS RN: HS code: 2931.39

Key: (464-07-3)-1A2-EI

Molecular formula: C<sub>12</sub>H<sub>25</sub>N<sub>2</sub>O<sub>2</sub>P

CAS Index Name:

**IUPAC name:**

Synonyms:

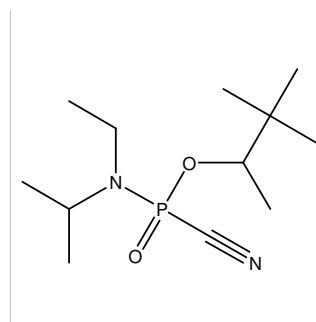

**Chemical name:** Pinacolyl N-ethyl-N-methylphosphoramidocyanidate

Schedule: 1A02

CAS RN:

HS code: 2931.39

Key: (464-07-3)-1A2-EM

Molecular formula: C<sub>10</sub>H<sub>21</sub>N<sub>2</sub>O<sub>2</sub>P

CAS Index Name:

**IUPAC name:**

Synonyms:

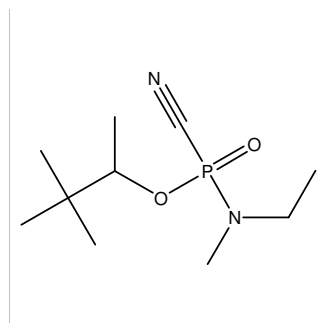

**Chemical name:** Pinacolyl N-ethyl-N-propylphosphoramidocyanidate

Schedule: 1A02

CAS RN:

HS code: 2931.39

Key: (464-07-3)-1A2-EP

Molecular formula: C<sub>12</sub>H<sub>25</sub>N<sub>2</sub>O<sub>2</sub>P

CAS Index Name:

**IUPAC name:**

Synonyms:

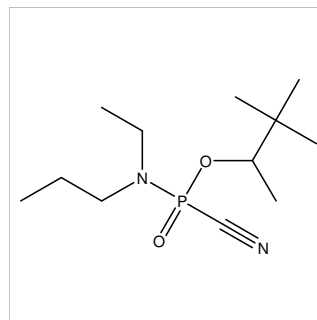

**Chemical name:** Pinacolyl N,N-diisopropylphosphoramidocyanidate

Schedule: 1A02

CAS RN:

HS code: 2931.39

Key: (464-07-3)-1A2-II

Molecular formula: C<sub>13</sub>H<sub>27</sub>N<sub>2</sub>O<sub>2</sub>P

CAS Index Name: Phosphoramidocyanidic acid, bis(1-methylethyl)-, 1,2,2-trimethylpropyl ester

**IUPAC name:** 1,2,2-Trimethylpropyl diisopropylphosphoramidocyanidoate

Synonyms: Phosphoramidocyanidic acid, bis(N-1-methylethyl)-, 1,2,2-trimethylpropyl ester

O-Pinacolyl N,N-diisopropylphosphoramidocyanidate

O-1,2,2-Trimethylpropyl N,N-diisopropylphosphoramidocyanidate

3,3-Dimethylbutan-2-yl N,N-diisopropylphosphoramidocyanidate

3,3-Dimethylbut-2-yl N,N-diisopropylphosphoramidocyanidate

1,2,2-Trimethylpropyl diisopropylamidocyanidophosphate

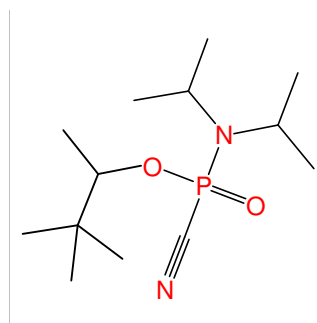

**Chemical name:** Pinacolyl N-isopropyl-N-propylphosphoramidocyanidate

Schedule: 1A02

CAS RN: HS code: 2931.39

Key: (464-07-3)-1A2-IP

Molecular formula: C<sub>13</sub>H<sub>27</sub>N<sub>2</sub>O<sub>2</sub>P

CAS Index Name: Phosphoramidocyanidic acid, (1-methylethyl)propyl-, 1,2,2-trimethylpropyl ester

**IUPAC name:** 1,2,2-Trimethylpropyl isopropylpropylphosphoramidocyanidoate

Synonyms: Phosphoramidocyanidic acid, N-1-methylethyl-N-propyl-, 1,2,2-trimethylpropyl ester

O-Pinacolyl N-isopropyl-N-propylphosphoramidocyanidate

O-1,2,2-Trimethylpropyl N-isopropyl-N-propylphosphoramidocyanidate

3,3-Dimethylbutan-2-yl N-isopropyl-N-propylphosphoramidocyanidate

3,3-Dimethylbut-2-yl N-isopropyl-N-propylphosphoramidocyanidate

1,2,2-Trimethylpropyl isopropyl(propyl)amidocyanidophosphate

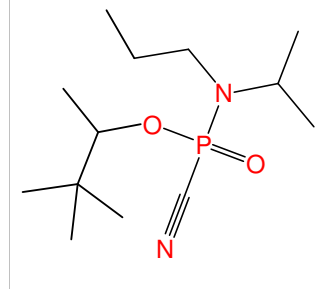

**Chemical name:** Pinacolyl N,N-dimethylphosphoramidocyanidate

Schedule: 1A02

CAS RN: HS code: 2931.39

Key: (464-07-3)-1A2-MM

Molecular formula: C<sub>9</sub>H<sub>19</sub>N<sub>2</sub>O<sub>2</sub>P

CAS Index Name: Phosphoramidocyanidic acid, dimethyl-, 1,2,2-trimethylpropyl ester

**IUPAC name:** 1,2,2-Trimethylpropyl dimethylphosphoramidocyanidoate

Synonyms: Phosphoramidocyanidic acid, N,N-dimethyl-, 1,2,2-trimethylpropyl ester

O-Pinacolyl N,N-dimethylphosphoramidocyanidate

O-1,2,2-Trimethylpropyl N,N-dimethylphosphoramidocyanidate

3,3-Dimethylbutan-2-yl N,N-dimethylphosphoramidocyanidate

3,3-Dimethylbut-2-yl N,N-dimethylphosphoramidocyanidate

1,2,2-Trimethylpropyl dimethylamidocyanidophosphate

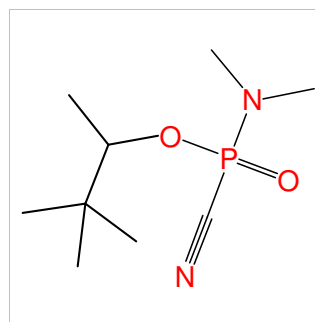

**Chemical name:** Pinacolyl N-methyl-N-propylphosphoramidocyanidate

Schedule: 1A02

CAS RN: HS code: 2931.39

Key: (464-07-3)-1A2-MP

Molecular formula: C<sub>11</sub>H<sub>23</sub>N<sub>2</sub>O<sub>2</sub>P

CAS Index Name:

**IUPAC name:**

Synonyms:

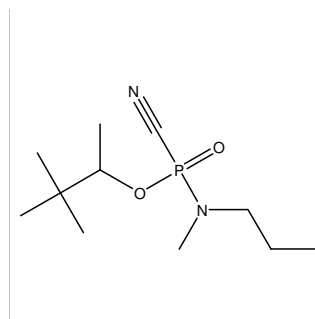

**Chemical name:** 1,5-Dimethylhexyl N,N-dimethylphosphoramidocyanidate

Schedule: 1A02

CAS RN:

HS code: 2931.39

Key: (4730-22-7)-1A2-MM

Molecular formula: C<sub>11</sub>H<sub>23</sub>N<sub>2</sub>O<sub>2</sub>P

CAS Index Name:

**IUPAC name:**

Synonyms:

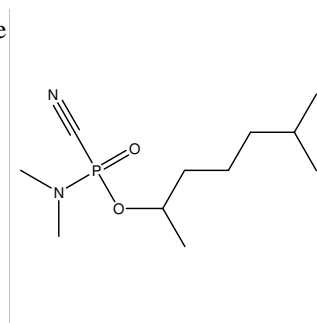

**Chemical name:** Cycloheptyl N-ethyl-N-isopropylphosphoramidocyanidate

Schedule: 1A02

CAS RN:

HS code: 2931.39

Key: (502-41-0)-1A2-EI

Molecular formula: C<sub>13</sub>H<sub>25</sub>N<sub>2</sub>O<sub>2</sub>P

CAS Index Name:

**IUPAC name:**

Synonyms:

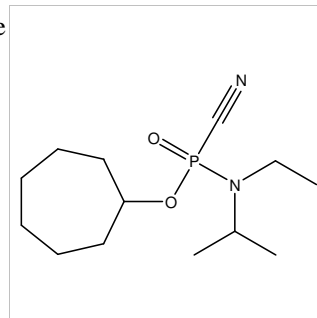

**Chemical name:** Cycloheptyl N-ethyl-N-methylphosphoramidocyanidate

Schedule: 1A02

CAS RN:

HS code: 2931.39

Key: (502-41-0)-1A2-EM

Molecular formula: C<sub>11</sub>H<sub>21</sub>N<sub>2</sub>O<sub>2</sub>P

CAS Index Name:

**IUPAC name:**

Synonyms:

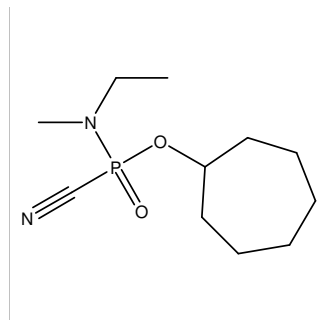

**Chemical name:** Cycloheptyl N-ethyl-N-propylphosphoramidocyanidate

Schedule: 1A02

CAS RN:

HS code: 2931.39

Key: (502-41-0)-1A2-EP

Molecular formula: C<sub>13</sub>H<sub>25</sub>N<sub>2</sub>O<sub>2</sub>P

CAS Index Name:

**IUPAC name:**

Synonyms:

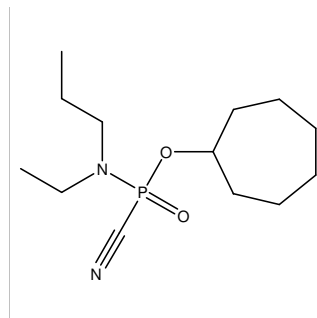

**Chemical name:** Cycloheptyl N-isopropyl-N-methylphosphoramidocyanidate

Schedule: 1A02

CAS RN: HS code: 2931.39

Key: (502-41-0)-1A2-IM

Molecular formula: C<sub>12</sub>H<sub>23</sub>N<sub>2</sub>O<sub>2</sub>P

CAS Index Name:

**IUPAC name:**

Synonyms:

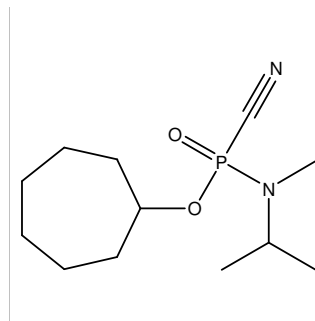

**Chemical name:** Cycloheptyl N-methyl-N-propylphosphoramidocyanidate

Schedule: 1A02

CAS RN: HS code: 2931.39

Key: (502-41-0)-1A2-MP

Molecular formula: C<sub>12</sub>H<sub>23</sub>N<sub>2</sub>O<sub>2</sub>P

CAS Index Name:

**IUPAC name:**

Synonyms:

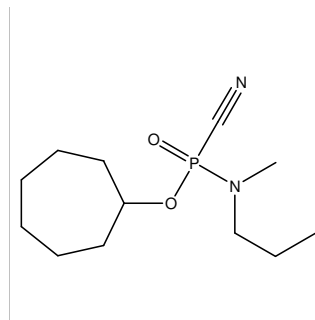

**Chemical name:** 2-Norbornanemethyl N,N-dimethylphosphoramidocyanidate

Schedule: 1A02

CAS RN: HS code: 2931.39

Key: (5240-72-2)-1A2-MM

Molecular formula: C<sub>11</sub>H<sub>19</sub>N<sub>2</sub>O<sub>2</sub>P

CAS Index Name:

**IUPAC name:**

Synonyms: 2-Norbornylmethyl N,N-dimethylphosphoramidocyanidate

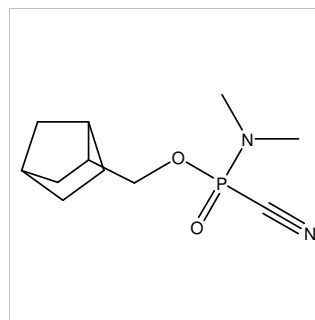

**Chemical name:** 1-Methylhexyl N,N-diethylphosphoramidocyanidate

Schedule: 1A02

CAS RN: HS code: 2931.39

Key: (543-49-7)-1A2-EE

Molecular formula: C<sub>12</sub>H<sub>25</sub>N<sub>2</sub>O<sub>2</sub>P

CAS Index Name:

**IUPAC name:**

Synonyms:

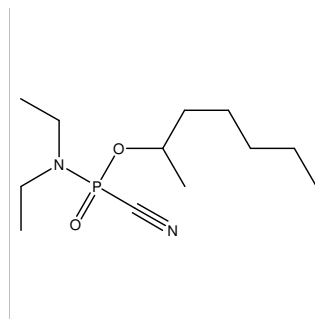

**Chemical name:** 1-Methylhexyl N,N-diisopropylphosphoramidocyanidate

Schedule: 1A02

CAS RN:

HS code: 2931.39

Key: (543-49-7)-1A2-II

Molecular formula: C<sub>14</sub>H<sub>29</sub>N<sub>2</sub>O<sub>2</sub>P

CAS Index Name:

**IUPAC name:**

Synonyms:

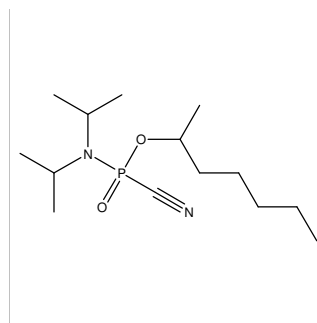

**Chemical name:** 1-Methylhexyl N,N-dipropylphosphoramidocyanidate

Schedule: 1A02

CAS RN:

HS code: 2931.39

Key: (543-49-7)-1A2-PP

Molecular formula: C<sub>14</sub>H<sub>29</sub>N<sub>2</sub>O<sub>2</sub>P

CAS Index Name:

**IUPAC name:**

Synonyms:

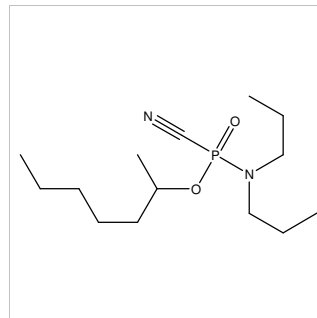

**Chemical name:** 3,5-Dimethylcyclohexyl N,N-dimethylphosphoramidocyanidate

Schedule: 1A02

CAS RN:

HS code: 2931.39

Key: (5441-52-1)-1A2-MM

Molecular formula: C<sub>11</sub>H<sub>21</sub>N<sub>2</sub>O<sub>2</sub>P

CAS Index Name:

**IUPAC name:**

Synonyms:

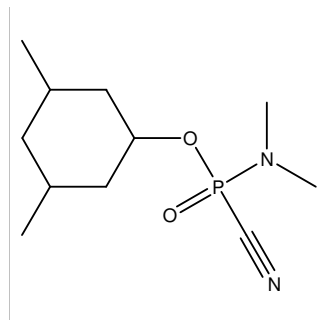

**Chemical name:** 1-Ethyl-1-methylpentyl N,N-dimethylphosphoramidocyanidate

Schedule: 1A02

CAS RN: HS code: 2931.39

Key: (5582-82-1)-1A2-MM

Molecular formula: C<sub>11</sub>H<sub>23</sub>N<sub>2</sub>O<sub>2</sub>P

CAS Index Name: Phosphoramidocyanidic acid, dimethyl-, 1-ethyl-1-methylpentyl ester

**IUPAC name:** 1-Ethyl-1-methylpentyl dimethylphosphoramidocyanidoate

Synonyms: O-1-Ethyl-1-methylpentyl N,N-dimethylphosphoramidocyanidate

3-Methylheptan-3-yl N,N-dimethylphosphoramidocyanidate

3-Methylhept-3-yl N,N-dimethylphosphoramidocyanidate

1-Ethyl-1-methylpentyl dimethylamidocyanidophosphate

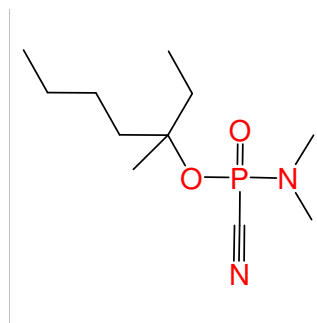

**Chemical name:** 1,2-Dimethylbutyl N,N-diethylphosphoramidocyanidate

Schedule: 1A02

CAS RN: HS code: 2931.39

Key: (565-60-6)-1A2-EE

Molecular formula: C<sub>11</sub>H<sub>23</sub>N<sub>2</sub>O<sub>2</sub>P

CAS Index Name:

**IUPAC name:**

Synonyms:

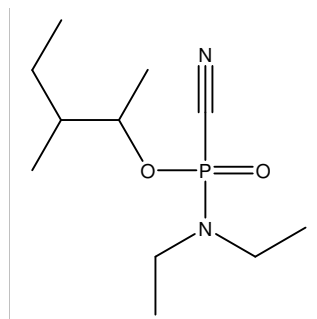

**Chemical name:** 1,2-Dimethylbutyl N-ethyl-N-isopropylphosphoramidocyanidate

Schedule: 1A02

CAS RN: HS code: 2931.39

Key: (565-60-6)-1A2-EI

Molecular formula: C<sub>12</sub>H<sub>25</sub>N<sub>2</sub>O<sub>2</sub>P

CAS Index Name:

**IUPAC name:**

Synonyms:

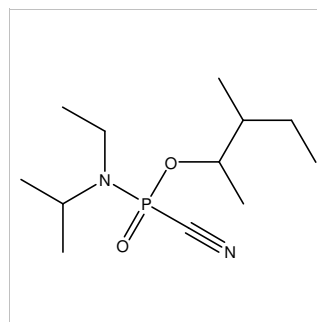



**Chemical name:** 1,2-Dimethylbutyl N-ethyl-N-methylphosphoramidocyanidate

Schedule: 1A02

CAS RN: HS code: 2931.39

Key: (565-60-6)-1A2-EM

Molecular formula: C<sub>10</sub>H<sub>21</sub>N<sub>2</sub>O<sub>2</sub>P

CAS Index Name:

**IUPAC name:**

Synonyms:

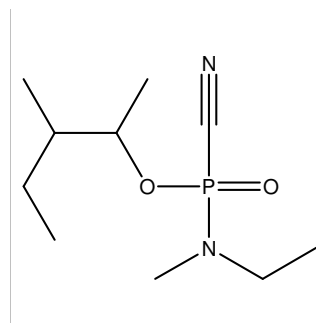

**Chemical name:** 1,2-Dimethylbutyl N-ethyl-N-propylphosphoramidocyanidate

Schedule: 1A02

CAS RN: HS code: 2931.39

Key: (565-60-6)-1A2-EP

Molecular formula: C<sub>12</sub>H<sub>25</sub>N<sub>2</sub>O<sub>2</sub>P

CAS Index Name:

**IUPAC name:**

Synonyms:

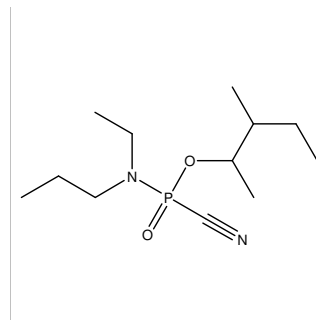

**Chemical name:** 1,2-Dimethylbutyl N,N-diisopropylphosphoramidocyanidate

Schedule: 1A02

CAS RN: HS code: 2931.39

Key: (565-60-6)-1A2-II

Molecular formula: C<sub>13</sub>H<sub>27</sub>N<sub>2</sub>O<sub>2</sub>P

CAS Index Name:

**IUPAC name:**

Synonyms:

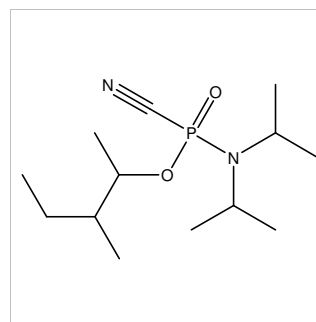

**Chemical name:** 1,2-Dimethylbutyl N-isopropyl-N-methylphosphoramidocyanidate

Schedule: 1A02

CAS RN: HS code: 2931.39

Key: (565-60-6)-1A2-IM

Molecular formula: C<sub>11</sub>H<sub>23</sub>N<sub>2</sub>O<sub>2</sub>P

CAS Index Name:

**IUPAC name:**

Synonyms:

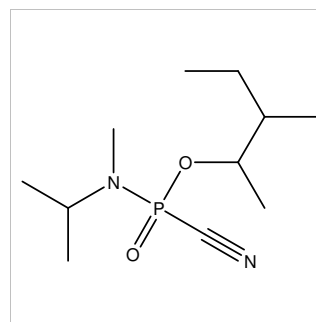

**Chemical name:** 1,2-Dimethylbutyl N,N-dimethylphosphoramidocyanidate

Schedule: 1A02

CAS RN: HS code: 2931.39

Key: (565-60-6)-1A2-MM

Molecular formula: C<sub>9</sub>H<sub>19</sub>N<sub>2</sub>O<sub>2</sub>P

CAS Index Name: Phosphoramidocyanidic acid, dimethyl-, 1,2-dimethylbutyl ester

**IUPAC name:**

Synonyms:

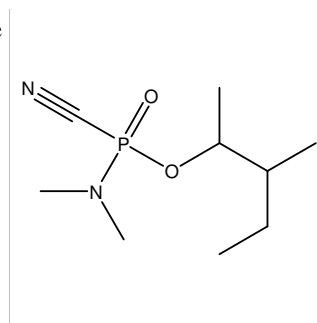

**Chemical name:** 1,2-Dimethylbutyl N-methyl-N-propylphosphoramidocyanidate

Schedule: 1A02

CAS RN: HS code: 2931.39

Key: (565-60-6)-1A2-MP

Molecular formula: C<sub>11</sub>H<sub>23</sub>N<sub>2</sub>O<sub>2</sub>P

CAS Index Name:

**IUPAC name:**

Synonyms:

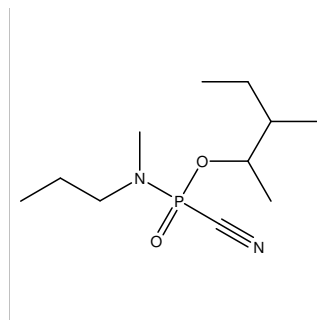

**Chemical name:** 1,2-Dimethylbutyl N,N-dipropylphosphoramidocyanidate

Schedule: 1A02

CAS RN: HS code: 2931.39

Key: (565-60-6)-1A2-PP

Molecular formula: C<sub>13</sub>H<sub>27</sub>N<sub>2</sub>O<sub>2</sub>P

CAS Index Name:

**IUPAC name:**

Synonyms:

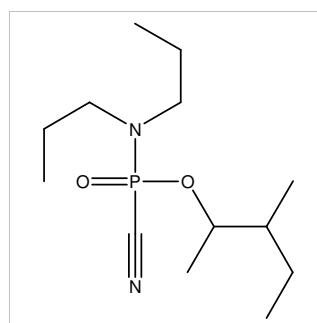

**Chemical name:** 1-Ethyl-2-methylpropyl N,N-dimethylphosphoramidocyanidate

Schedule: 1A02

CAS RN: HS code: 2931.39

Key: (565-67-3)-1A2-MM

Molecular formula: C<sub>9</sub>H<sub>19</sub>N<sub>2</sub>O<sub>2</sub>P

CAS Index Name:

**IUPAC name:**

Synonyms:

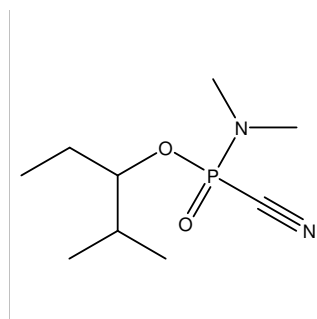

**Chemical name:** 1,5-Dimethyl-1-ethylhexyl N,N-dimethylphosphoramidocyanidate

Schedule: 1A02

CAS RN: HS code: 2931.39

Key: (57706-88-4)-1A2-MM

Molecular formula: C<sub>13</sub>H<sub>27</sub>N<sub>2</sub>O<sub>2</sub>P

CAS Index Name: Phosphoramidocyanidic acid, dimethyl-, 1,5-dimethyl-1-ethylhexyl ester

**IUPAC name:** 1,5-Dimethyl-1-ethylhexyl dimethylphosphoramidocyanidoate

Synonyms: O-1,5-Dimethyl-1-ethylhexyl N,N-dimethylphosphoramidocyanidate

3,7-Dimethyloctan-3-yl N,N-dimethylphosphoramidocyanidate

3,7-Dimethyloct-3-yl N,N-dimethylphosphoramidocyanidate

1,5-Dimethyl-1-ethylhexyl dimethylamidocyanidophosphate

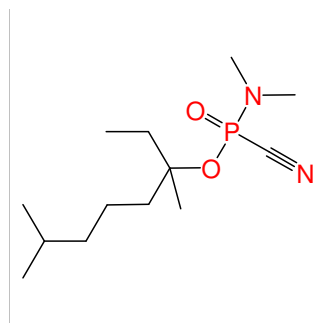

**Chemical name:** 2-Propylpentyl N,N-dimethylphosphoramidocyanidate

Schedule: 1A02

CAS RN: HS code: 2931.39

Key: (58175-57-8)-1A2-MM

Molecular formula: C<sub>11</sub>H<sub>23</sub>N<sub>2</sub>O<sub>2</sub>P

CAS Index Name:

**IUPAC name:**

Synonyms:

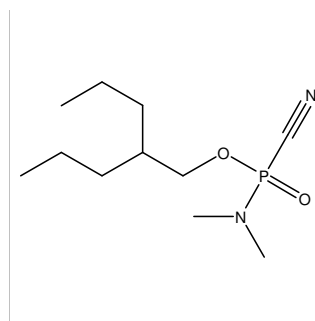

**Chemical name:** 2-Methylcyclohexyl N,N-diethylphosphoramidocyanidate

Schedule: 1A02

CAS RN: HS code: 2931.39

Key: (583-59-5)-1A2-EE

Molecular formula: C<sub>12</sub>H<sub>23</sub>N<sub>2</sub>O<sub>2</sub>P

CAS Index Name:

**IUPAC name:**

Synonyms:

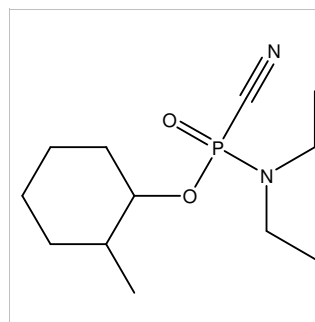

**Chemical name:** 2-Methylcyclohexyl N-ethyl-N-isopropylphosphoramidocyanidate

Schedule: 1A02

CAS RN: HS code: 2931.39

Key: (583-59-5)-1A2-EI

Molecular formula: C<sub>13</sub>H<sub>25</sub>N<sub>2</sub>O<sub>2</sub>P

CAS Index Name:

**IUPAC name:**

Synonyms:

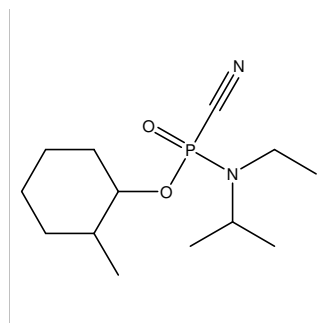

**Chemical name:** 2-Methylcyclohexyl N-ethyl-N-methylphosphoramidocyanidate

Schedule: 1A02

CAS RN: HS code: 2931.39

Key: (583-59-5)-1A2-EM

Molecular formula: C<sub>11</sub>H<sub>21</sub>N<sub>2</sub>O<sub>2</sub>P

CAS Index Name:

**IUPAC name:**

Synonyms:

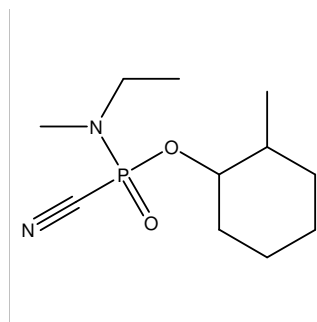

**Chemical name:** 2-Methylcyclohexyl N-ethyl-N-propylphosphoramidocyanidate

Schedule: 1A02

CAS RN: HS code: 2931.39

Key: (583-59-5)-1A2-EP

Molecular formula: C<sub>13</sub>H<sub>25</sub>N<sub>2</sub>O<sub>2</sub>P

CAS Index Name:

**IUPAC name:**

Synonyms:

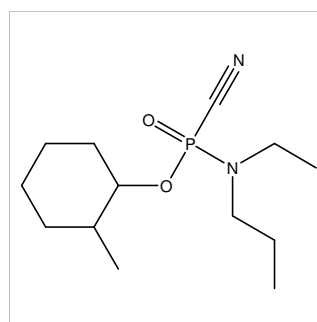

**Chemical name:** 2-Methylcyclohexyl N-isopropyl-N-methylphosphoramidocyanidate

Schedule: 1A02

CAS RN: HS code: 2931.39

Key: (583-59-5)-1A2-IM

Molecular formula: C<sub>12</sub>H<sub>23</sub>N<sub>2</sub>O<sub>2</sub>P

CAS Index Name:

**IUPAC name:**

Synonyms:

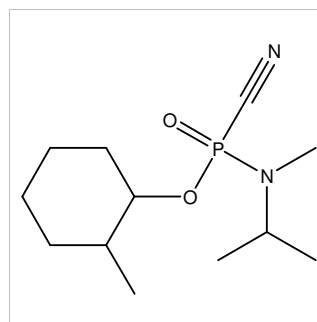

**Chemical name:** 2-Methylcyclohexyl N,N-dimethylphosphoramidocyanidate

Schedule: 1A02

CAS RN: HS code: 2931.39

Key: (583-59-5)-1A2-MM

Molecular formula: C<sub>10</sub>H<sub>19</sub>N<sub>2</sub>O<sub>2</sub>P

CAS Index Name:

**IUPAC name:**

Synonyms:

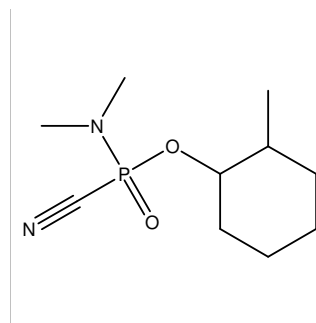

**Chemical name:** 2-Methylcyclohexyl N-methyl-N-propylphosphoramidocyanidate

Schedule: 1A02

CAS RN: HS code: 2931.39

Key: (583-59-5)-1A2-MP

Molecular formula: C<sub>12</sub>H<sub>23</sub>N<sub>2</sub>O<sub>2</sub>P

CAS Index Name:

**IUPAC name:**

Synonyms:

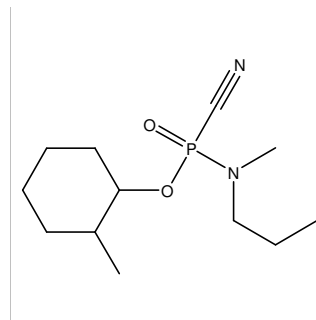

**Chemical name:** 2-Methylcyclohexyl N,N-dipropylphosphoramidocyanidate

Schedule: 1A02

CAS RN: HS code: 2931.39

Key: (583-59-5)-1A2-PP

Molecular formula: C<sub>14</sub>H<sub>27</sub>N<sub>2</sub>O<sub>2</sub>P

CAS Index Name:

**IUPAC name:**

Synonyms:

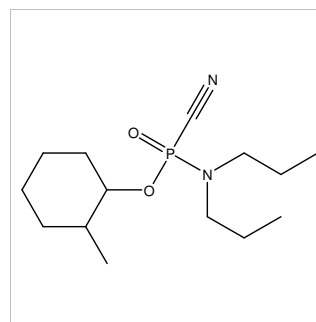

**Chemical name:** 1-Ethylpropyl N,N-diethylphosphoramidocyanidate

Schedule: 1A02

CAS RN: HS code: 2931.39

Key: (584-02-1)-1A2-EE

Molecular formula: C<sub>10</sub>H<sub>21</sub>N<sub>2</sub>O<sub>2</sub>P

CAS Index Name:

**IUPAC name:**

Synonyms:

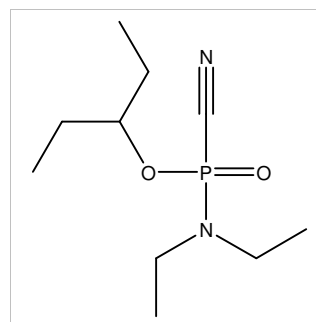

**Chemical name:** 1-Ethylpropyl N,N-diisopropylphosphoramidocyanidate

Schedule: 1A02

CAS RN:

HS code: 2931.39

Key: (584-02-1)-1A2-II

Molecular formula: C<sub>12</sub>H<sub>25</sub>N<sub>2</sub>O<sub>2</sub>P

CAS Index Name:

**IUPAC name:**

Synonyms:

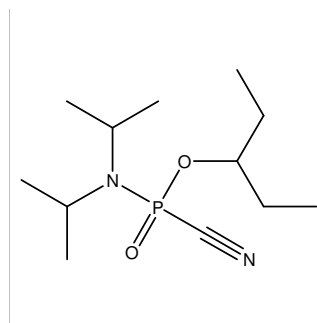

**Chemical name:** 1-Ethylpropyl N,N-dimethylphosphoramidocyanidate

Schedule: 1A02

CAS RN:

HS code: 2931.39

Key: (584-02-1)-1A2-MM

Molecular formula: C<sub>8</sub>H<sub>17</sub>N<sub>2</sub>O<sub>2</sub>P

CAS Index Name:

**IUPAC name:**

Synonyms:

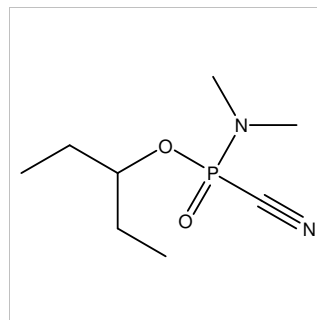

**Chemical name:** 1-Ethylpropyl N,N-dipropylphosphoramidocyanidate

Schedule: 1A02

CAS RN:

HS code: 2931.39

Key: (584-02-1)-1A2-PP

Molecular formula: C<sub>12</sub>H<sub>25</sub>N<sub>2</sub>O<sub>2</sub>P

CAS Index Name:

**IUPAC name:**

Synonyms:

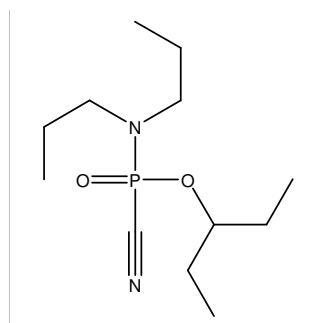

**Chemical name:** 3-Methylpentyl N,N-dimethylphosphoramidocyanidate

Schedule: 1A02

CAS RN:

HS code: 2931.39

Key: (589-35-5)-1A2-MM

Molecular formula: C<sub>9</sub>H<sub>19</sub>N<sub>2</sub>O<sub>2</sub>P

CAS Index Name:

**IUPAC name:**

Synonyms:

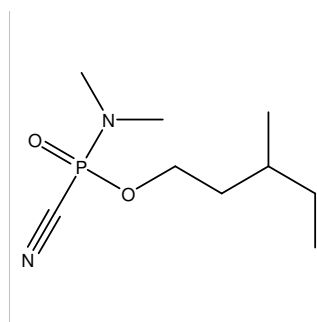

**Chemical name:** 1-Propylpentyl N,N-dimethylphosphoramidocyanidate

Schedule: 1A02

CAS RN:

HS code: 2931.39

Key: (589-62-8)-1A2-MM

Molecular formula: C<sub>11</sub>H<sub>23</sub>N<sub>2</sub>O<sub>2</sub>P

CAS Index Name:

**IUPAC name:**

Synonyms:

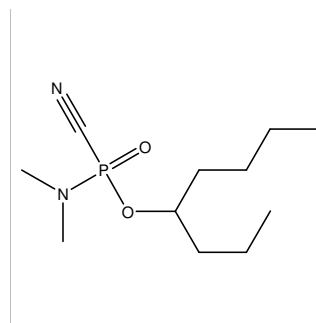

**Chemical name:** 1-Ethylpentyl N,N-dimethylphosphoramidocyanidate

Schedule: 1A02

CAS RN:

HS code: 2931.39

Key: (589-82-2)-1A2-MM

Molecular formula: C<sub>10</sub>H<sub>21</sub>N<sub>2</sub>O<sub>2</sub>P

CAS Index Name:

**IUPAC name:**

Synonyms:

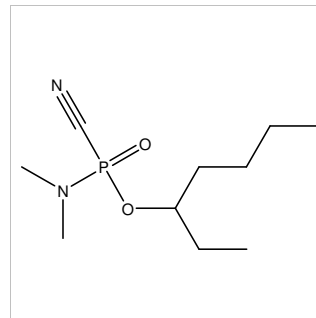

**Chemical name:** 4-Methylcyclohexyl N,N-diethylphosphoramidocyanidate

Schedule: 1A02

CAS RN:

HS code: 2931.39

Key: (589-91-3)-1A2-EE

Molecular formula: C<sub>12</sub>H<sub>23</sub>N<sub>2</sub>O<sub>2</sub>P

CAS Index Name:

**IUPAC name:**

Synonyms:

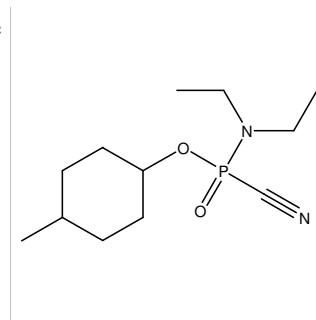

**Chemical name:** 4-Methylcyclohexyl N-ethyl-N-isopropylphosphoramidocyanidate

Schedule: 1A02

CAS RN:

HS code: 2931.39

Key: (589-91-3)-1A2-EI

Molecular formula: C<sub>13</sub>H<sub>25</sub>N<sub>2</sub>O<sub>2</sub>P

CAS Index Name:

**IUPAC name:**

Synonyms:

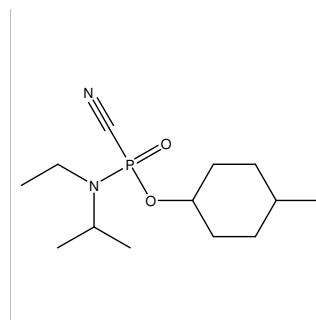

**Chemical name:** 4-Methylcyclohexyl N-ethyl-N-methylphosphoramidocyanidate

Schedule: 1A02

CAS RN: HS code: 2931.39

Key: (589-91-3)-1A2-EM

Molecular formula: C<sub>11</sub>H<sub>21</sub>N<sub>2</sub>O<sub>2</sub>P

CAS Index Name:

**IUPAC name:**

Synonyms:

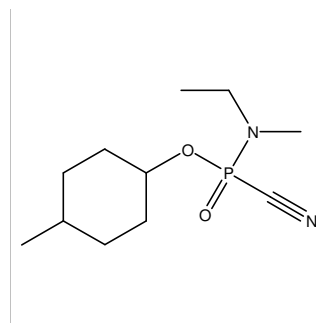

**Chemical name:** 4-Methylcyclohexyl N-ethyl-N-propylphosphoramidocyanidate

Schedule: 1A02

CAS RN: HS code: 2931.39

Key: (589-91-3)-1A2-EP

Molecular formula: C<sub>13</sub>H<sub>25</sub>N<sub>2</sub>O<sub>2</sub>P

CAS Index Name:

**IUPAC name:**

Synonyms:

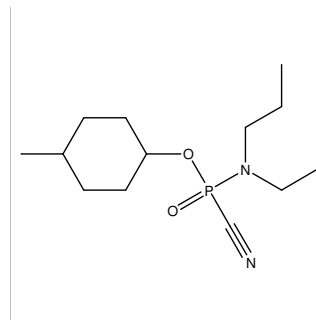

**Chemical name:** 4-Methylcyclohexyl N,N-diisopropylphosphoramidocyanidate

Schedule: 1A02

CAS RN: HS code: 2931.39

Key: (589-91-3)-1A2-II

Molecular formula: C<sub>14</sub>H<sub>27</sub>N<sub>2</sub>O<sub>2</sub>P

CAS Index Name:

**IUPAC name:**

Synonyms:

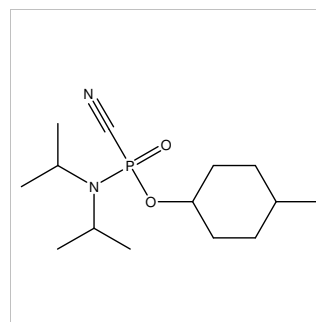

**Chemical name:** 4-Methylcyclohexyl N-isopropyl-N-methylphosphoramidocyanidate

Schedule: 1A02

CAS RN: HS code: 2931.39

Key: (589-91-3)-1A2-IM

Molecular formula: C<sub>12</sub>H<sub>23</sub>N<sub>2</sub>O<sub>2</sub>P

CAS Index Name:

**IUPAC name:**

Synonyms:

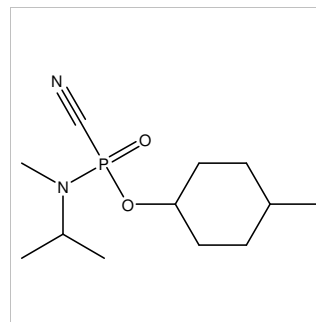



**Chemical name:** 4-Methylcyclohexyl N,N-dimethylphosphoramidocyanidate

Schedule: 1A02

CAS RN: HS code: 2931.39

Key: (589-91-3)-1A2-MM

Molecular formula: C<sub>10</sub>H<sub>19</sub>N<sub>2</sub>O<sub>2</sub>P

CAS Index Name:

**IUPAC name:**

Synonyms:

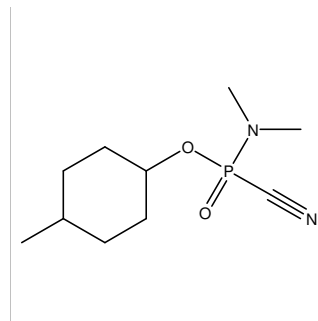

**Chemical name:** 4-Methylcyclohexyl N-methyl-N-propylphosphoramidocyanidate

Schedule: 1A02

CAS RN: HS code: 2931.39

Key: (589-91-3)-1A2-MP

Molecular formula: C<sub>12</sub>H<sub>23</sub>N<sub>2</sub>O<sub>2</sub>P

CAS Index Name:

**IUPAC name:**

Synonyms:

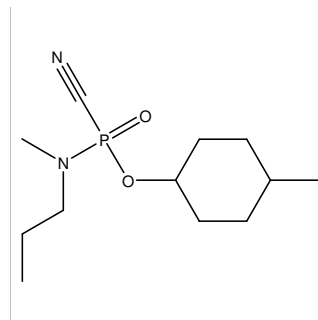

**Chemical name:** 4-Methylcyclohexyl N,N-dipropylphosphoramidocyanidate

Schedule: 1A02

CAS RN: HS code: 2931.39

Key: (589-91-3)-1A2-PP

Molecular formula: C<sub>14</sub>H<sub>27</sub>N<sub>2</sub>O<sub>2</sub>P

CAS Index Name:

**IUPAC name:**

Synonyms:

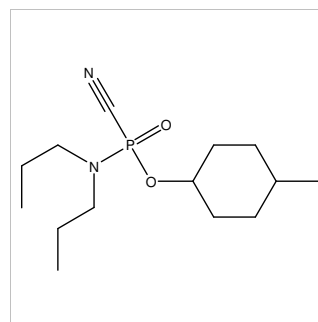

**Chemical name:** 1-Methylcyclohexyl N,N-diisopropylphosphoramidocyanidate

Schedule: 1A02

CAS RN: HS code: 2931.39

Key: (590-67-0)-1A2-II

Molecular formula: C<sub>14</sub>H<sub>27</sub>N<sub>2</sub>O<sub>2</sub>P

CAS Index Name: Phosphoramidocyanidic acid, bis(1-methylethyl)-, 1-methylcyclohexyl ester

**IUPAC name:** 1-Methylcyclohexyl diisopropylphosphoramidocyanidoate

Synonyms: Phosphoramidocyanidic acid, bis(N-1-methylethyl)-, 1-methylcyclohexyl ester

O-1-Methylcyclohexyl N,N-diisopropylphosphoramidocyanidate

1-Methylcyclohexyl diisopropylamidocyanidophosphate

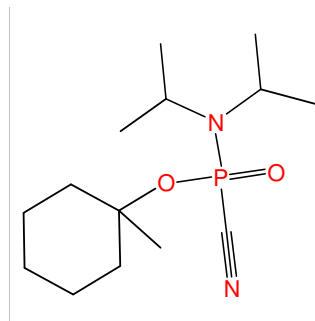

**Chemical name:** 3-Methylcyclohexyl N,N-diethylphosphoramidocyanidate

Schedule: 1A02

CAS RN: HS code: 2931.39

Key: (591-23-1)-1A2-EE

Molecular formula: C<sub>12</sub>H<sub>23</sub>N<sub>2</sub>O<sub>2</sub>P

CAS Index Name:

**IUPAC name:**

Synonyms:

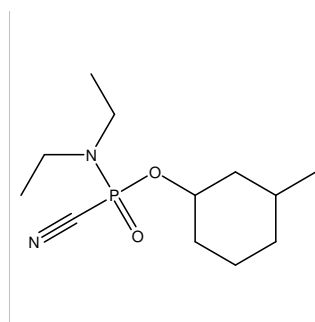

**Chemical name:** 3-Methylcyclohexyl N,N-diisopropylphosphoramidocyanidate

Schedule: 1A02

CAS RN: HS code: 2931.39

Key: (591-23-1)-1A2-II

Molecular formula: C<sub>14</sub>H<sub>27</sub>N<sub>2</sub>O<sub>2</sub>P

CAS Index Name:

**IUPAC name:**

Synonyms:

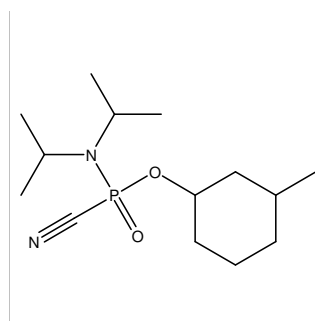

**Chemical name:** 3-Methylcyclohexyl N,N-dimethylphosphoramidocyanidate

Schedule: 1A02

CAS RN: HS code: 2931.39

Key: (591-23-1)-1A2-MM

Molecular formula: C<sub>10</sub>H<sub>19</sub>N<sub>2</sub>O<sub>2</sub>P

CAS Index Name:

**IUPAC name:**

Synonyms:

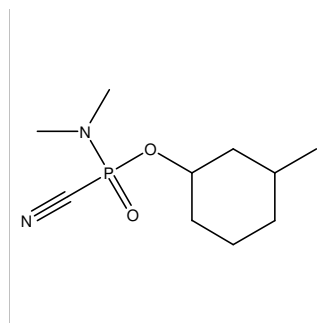

**Chemical name:** 3-Methylcyclohexyl N,N-dipropylphosphoramidocyanidate

Schedule: 1A02

CAS RN: HS code: 2931.39

Key: (591-23-1)-1A2-PP

Molecular formula: C<sub>14</sub>H<sub>27</sub>N<sub>2</sub>O<sub>2</sub>P

CAS Index Name:

**IUPAC name:**

Synonyms:

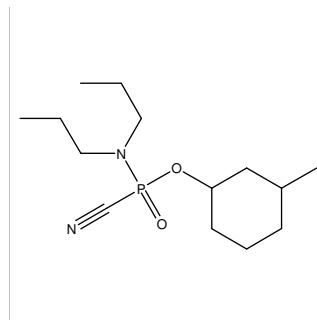

**Chemical name:** 1,1-Diethylpropyl N,N-dimethylphosphoramidocyanidate

Schedule: 1A02

CAS RN: HS code: 2931.39

Key: (597-49-9)-1A2-MM

Molecular formula: C<sub>10</sub>H<sub>21</sub>N<sub>2</sub>O<sub>2</sub>P

CAS Index Name: Phosphoramidocyanidic acid, dimethyl-, 1,1-diethylpropyl ester

**IUPAC name:** 1,1-Diethylpropyl dimethylphosphoramidocyanidoate

Synonyms: O-1,1-Diethylpropyl N,N-dimethylphosphoramidocyanidate

3-Ethylpentan-3-yl N,N-dimethylphosphoramidocyanidate

3-Ethylpent-3-yl N,N-dimethylphosphoramidocyanidate

1,1-Diethylpropyl dimethylamidocyanidophosphate

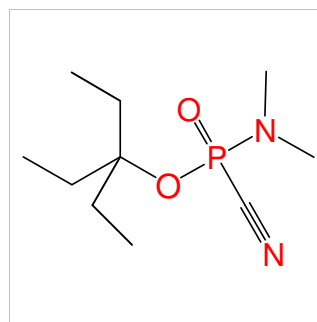

**Chemical name:** 1,2-Dimethylpropyl N,N-diethylphosphoramidocyanidate

Schedule: 1A02

CAS RN: HS code: 2931.39

Key: (598-75-4)-1A2-EE

Molecular formula: C<sub>10</sub>H<sub>21</sub>N<sub>2</sub>O<sub>2</sub>P

CAS Index Name:

**IUPAC name:**

Synonyms:

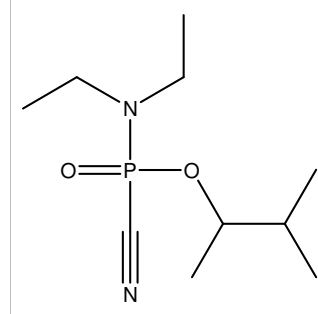

**Chemical name:** 1,2-Dimethylpropyl N,N-dimethylphosphoramidocyanidate

Schedule: 1A02

CAS RN: HS code: 2931.39

Key: (598-75-4)-1A2-MM

Molecular formula: C<sub>8</sub>H<sub>17</sub>N<sub>2</sub>O<sub>2</sub>P

CAS Index Name: Phosphoramidocyanidic acid, dimethyl-, 1,2-dimethylpropyl ester

**IUPAC name:** 1,2-Dimethylpropyl dimethylphosphoramidocyanidoate

Synonyms: O-1,2-Dimethylpropyl N,N-dimethylphosphoramidocyanidate

3-Methylbutan-2-yl N,N-dimethylphosphoramidocyanidate

3-Methylbut-2-yl N,N-dimethylphosphoramidocyanidate

1,2-Dimethylpropyl dimethylamidocyanidophosphate

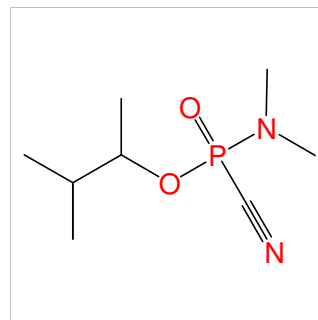

**Chemical name:** 1,2-Dimethylpropyl N,N-dipropylphosphoramidocyanidate

Schedule: 1A02

CAS RN: HS code: 2931.39

Key: (598-75-4)-1A2-PP

Molecular formula: C<sub>12</sub>H<sub>25</sub>N<sub>2</sub>O<sub>2</sub>P

CAS Index Name:

**IUPAC name:**

Synonyms:

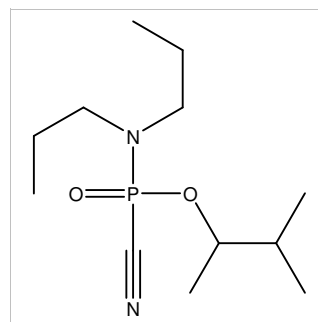

**Chemical name:** 1-Isopropyl-2-methylpropyl N-ethyl-N-propylphosphoramidocyanidate

Schedule: 1A02

CAS RN: HS code: 2931.39

Key: (600-36-2)-1A2-EP

Molecular formula: C<sub>13</sub>H<sub>27</sub>N<sub>2</sub>O<sub>2</sub>P

CAS Index Name:

**IUPAC name:**

Synonyms:

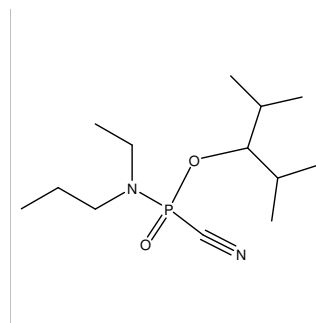

**Chemical name:** 1-Methylbutyl N,N-diethylphosphoramidocyanidate

Schedule: 1A02

CAS RN: HS code: 2931.39

Key: (6032-29-7)-1A2-EE

Molecular formula: C<sub>10</sub>H<sub>21</sub>N<sub>2</sub>O<sub>2</sub>P

CAS Index Name:

**IUPAC name:**

Synonyms:

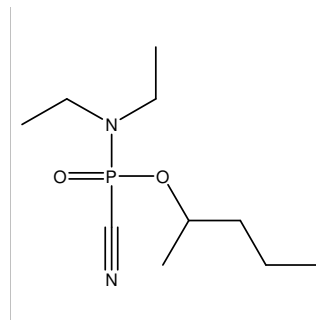

**Chemical name:** 1-Methylbutyl N-ethyl-N-isopropylphosphoramidocyanidate

Schedule: 1A02

CAS RN: HS code: 2931.39

Key: (6032-29-7)-1A2-EI

Molecular formula: C<sub>11</sub>H<sub>23</sub>N<sub>2</sub>O<sub>2</sub>P

CAS Index Name:

**IUPAC name:**

Synonyms:

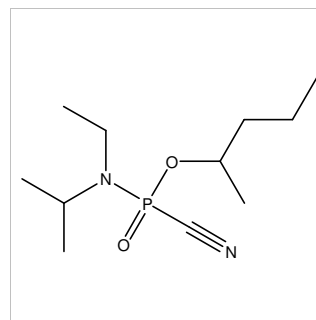

**Chemical name:** 1-Methylbutyl N-ethyl-N-methylphosphoramidocyanidate

Schedule: 1A02

CAS RN: HS code: 2931.39

Key: (6032-29-7)-1A2-EM

Molecular formula: C<sub>9</sub>H<sub>19</sub>N<sub>2</sub>O<sub>2</sub>P

CAS Index Name:

**IUPAC name:**

Synonyms:

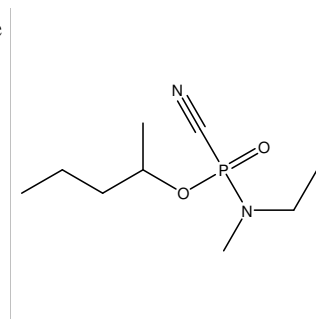

**Chemical name:** 1-Methylbutyl N-ethyl-N-propylphosphoramidocyanidate

Schedule: 1A02

CAS RN: HS code: 2931.39

Key: (6032-29-7)-1A2-EP

Molecular formula: C<sub>11</sub>H<sub>23</sub>N<sub>2</sub>O<sub>2</sub>P

CAS Index Name:

**IUPAC name:**

Synonyms:

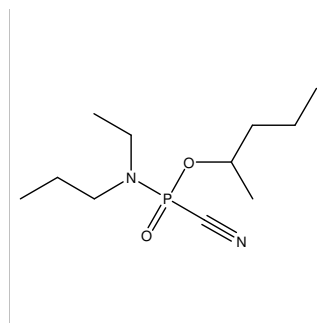

**Chemical name:** 1-Methylbutyl N-isopropyl-N-methylphosphoramidocyanidate

Schedule: 1A02

CAS RN: HS code: 2931.39

Key: (6032-29-7)-1A2-IM

Molecular formula: C<sub>10</sub>H<sub>21</sub>N<sub>2</sub>O<sub>2</sub>P

CAS Index Name:

**IUPAC name:**

Synonyms:

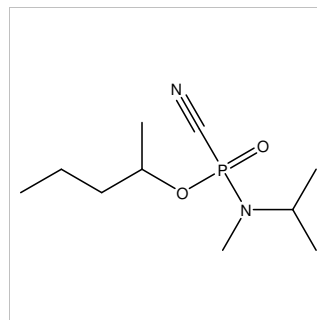

**Chemical name:** 1-Methylbutyl N,N-dimethylphosphoramidocyanidate

Schedule: 1A02

CAS RN: HS code: 2931.39

Key: (6032-29-7)-1A2-MM

Molecular formula: C<sub>8</sub>H<sub>17</sub>N<sub>2</sub>O<sub>2</sub>P

CAS Index Name:

**IUPAC name:**

Synonyms:

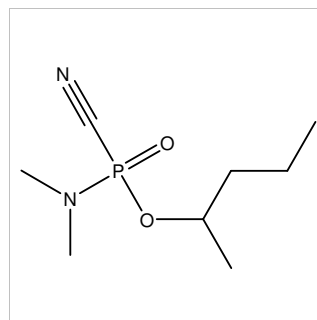

**Chemical name:** 1-Methylbutyl N-methyl-N-propylphosphoramidocyanidate

Schedule: 1A02

CAS RN: HS code: 2931.39

Key: (6032-29-7)-1A2-MP

Molecular formula: C<sub>10</sub>H<sub>21</sub>N<sub>2</sub>O<sub>2</sub>P

CAS Index Name:

**IUPAC name:**

Synonyms:

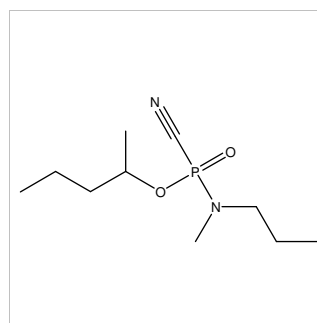

**Chemical name:** 1-Methylbutyl N,N-dipropylphosphoramidocyanidate

Schedule: 1A02

CAS RN:

HS code: 2931.39

Key: (6032-29-7)-1A2-PP

Molecular formula: C<sub>12</sub>H<sub>25</sub>N<sub>2</sub>O<sub>2</sub>P

CAS Index Name:

**IUPAC name:**

Synonyms:

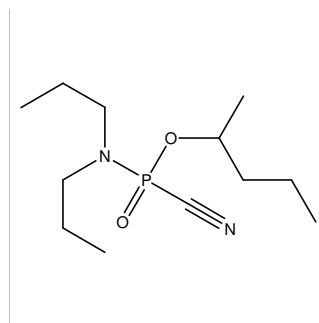

**Chemical name:** 1,3,3-Trimethylbutyl N,N-dimethylphosphoramidocyanidate

Schedule: 1A02

CAS RN:

HS code: 2931.39

Key: (6144-93-0)-1A2-MM

Molecular formula: C<sub>10</sub>H<sub>21</sub>N<sub>2</sub>O<sub>2</sub>P

CAS Index Name:

**IUPAC name:**

Synonyms:

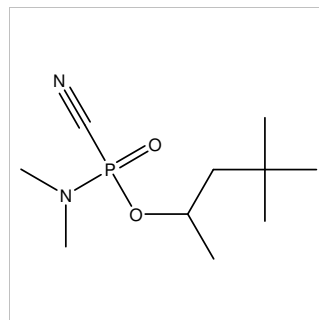

**Chemical name:** 1-Isopropylbutyl N,N-dimethylphosphoramidocyanidate

Schedule: 1A02

CAS RN:

HS code: 2931.39

Key: (617-29-8)-1A2-MM

Molecular formula: C<sub>10</sub>H<sub>21</sub>N<sub>2</sub>O<sub>2</sub>P

CAS Index Name:

**IUPAC name:**

Synonyms:

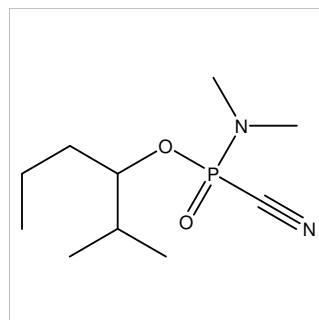

**Chemical name:** 1-Ethylbutyl N-ethyl-N-isopropylphosphoramidocyanidate

Schedule: 1A02

CAS RN:

HS code: 2931.39

Key: (623-37-0)-1A2-EI

Molecular formula: C<sub>12</sub>H<sub>25</sub>N<sub>2</sub>O<sub>2</sub>P

CAS Index Name:

**IUPAC name:**

Synonyms:

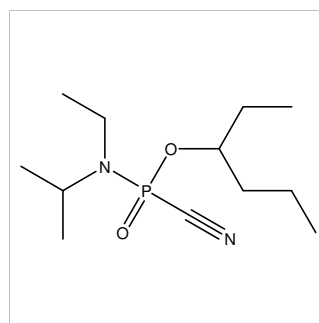

**Chemical name:** 1-Ethylbutyl N-ethyl-N-propylphosphoramidocyanidate

Schedule: 1A02

CAS RN:

HS code: 2931.39

Key: (623-37-0)-1A2-EP

Molecular formula: C<sub>12</sub>H<sub>25</sub>N<sub>2</sub>O<sub>2</sub>P

CAS Index Name:

**IUPAC name:**

Synonyms:

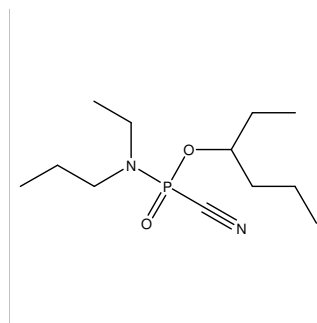

**Chemical name:** 1-Ethylbutyl N,N-dimethylphosphoramidocyanidate

Schedule: 1A02

CAS RN:

HS code: 2931.39

Key: (623-37-0)-1A2-MM

Molecular formula: C<sub>9</sub>H<sub>19</sub>N<sub>2</sub>O<sub>2</sub>P

CAS Index Name:

**IUPAC name:**

Synonyms:

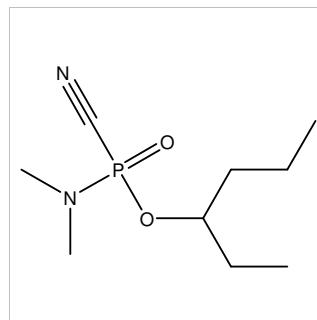

**Chemical name:** 1-Ethylbutyl N,N-dipropylphosphoramidocyanidate

Schedule: 1A02

CAS RN:

HS code: 2931.39

Key: (623-37-0)-1A2-PP

Molecular formula: C<sub>13</sub>H<sub>27</sub>N<sub>2</sub>O<sub>2</sub>P

CAS Index Name:

**IUPAC name:**

Synonyms:

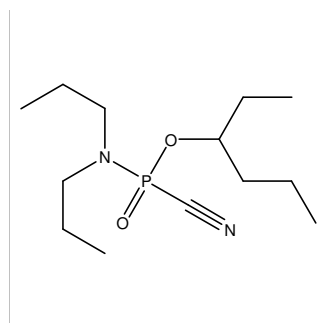

**Chemical name:** 1-Ethylbutyl N,N-diethylphosphoramidocyanidate

Schedule: 1A02

CAS RN:

HS code: 2931.39

Key: (623-38-0)-1A2-EE

Molecular formula: C<sub>11</sub>H<sub>23</sub>N<sub>2</sub>O<sub>2</sub>P

CAS Index Name:

**IUPAC name:**

Synonyms:

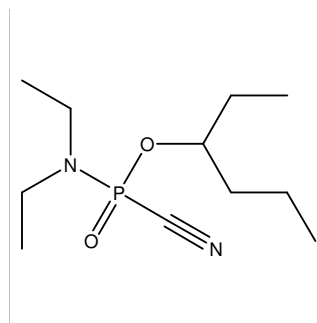



**Chemical name:** 1-Butylpentyl N,N-dimethylphosphoramidocyanidate

Schedule: 1A02

CAS RN:

HS code: 2931.39

Key: (623-93-8)-1A2-MM

Molecular formula: C<sub>12</sub>H<sub>25</sub>N<sub>2</sub>O<sub>2</sub>P

CAS Index Name:

**IUPAC name:**

Synonyms:

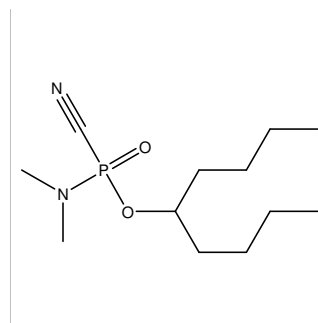

**Chemical name:** 1-Ethylheptyl N,N-dimethylphosphoramidocyanidate

Schedule: 1A02

CAS RN:

HS code: 2931.39

Key: (624-51-1)-1A2-MM

Molecular formula: C<sub>12</sub>H<sub>25</sub>N<sub>2</sub>O<sub>2</sub>P

CAS Index Name:

**IUPAC name:**

Synonyms:

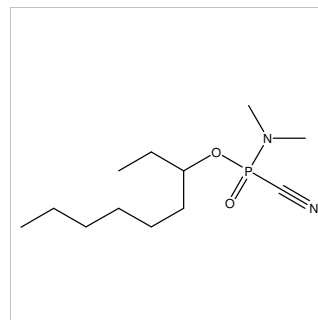

**Chemical name:** 3,3-Dimethylbutyl N,N-diethylphosphoramidocyanidate

Schedule: 1A02

CAS RN:

HS code: 2931.39

Key: (624-95-3)-1A2-EE

Molecular formula: C<sub>11</sub>H<sub>23</sub>N<sub>2</sub>O<sub>2</sub>P

CAS Index Name:

**IUPAC name:**

Synonyms:

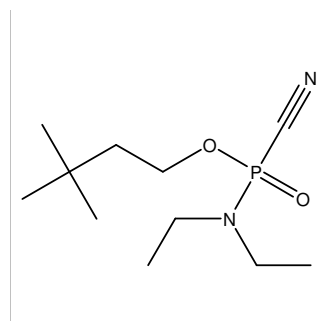

**Chemical name:** 3,3-Dimethylbutyl N,N-diisopropylphosphoramidocyanidate

Schedule: 1A02

CAS RN:

HS code: 2931.39

Key: (624-95-3)-1A2-II

Molecular formula: C<sub>13</sub>H<sub>27</sub>N<sub>2</sub>O<sub>2</sub>P

CAS Index Name:

**IUPAC name:**

Synonyms:

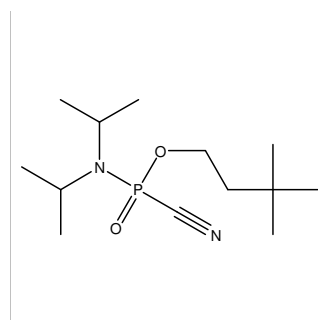

**Chemical name:** 3,3-Dimethylbutyl N,N-dimethylphosphoramidocyanidate

Schedule: 1A02

CAS RN:

HS code: 2931.39

Key: (624-95-3)-1A2-MM

Molecular formula: C<sub>9</sub>H<sub>19</sub>N<sub>2</sub>O<sub>2</sub>P

CAS Index Name:

**IUPAC name:**

Synonyms:

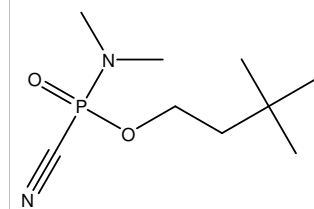

**Chemical name:** 3,3-Dimethylbutyl N,N-dipropylphosphoramidocyanidate

Schedule: 1A02

CAS RN:

HS code: 2931.39

Key: (624-95-3)-1A2-PP

Molecular formula: C<sub>13</sub>H<sub>27</sub>N<sub>2</sub>O<sub>2</sub>P

CAS Index Name:

**IUPAC name:**

Synonyms:

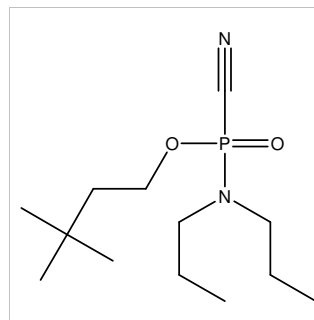

**Chemical name:** 4-Methylpentyl N,N-diethylphosphoramidocyanidate

Schedule: 1A02

CAS RN:

HS code: 2931.39

Key: (626-89-1)-1A2-EE

Molecular formula: C<sub>11</sub>H<sub>21</sub>N<sub>2</sub>O<sub>2</sub>P

CAS Index Name:

**IUPAC name:**

Synonyms:

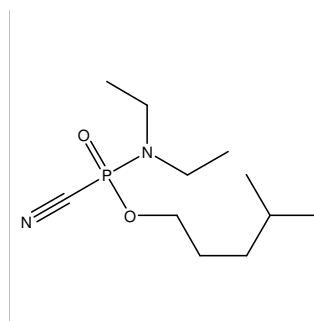

**Chemical name:** 4-Methylpentyl N,N-diisopropylphosphoramidocyanidate

Schedule: 1A02

CAS RN:

HS code: 2931.39

Key: (626-89-1)-1A2-II

Molecular formula: C<sub>13</sub>H<sub>27</sub>N<sub>2</sub>O<sub>2</sub>P

CAS Index Name:

**IUPAC name:**

Synonyms:

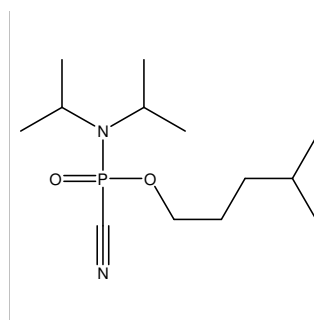

**Chemical name:** 4-Methylpentyl N,N-dimethylphosphoramidocyanidate

Schedule: 1A02

CAS RN:

HS code: 2931.39

Key: (626-89-1)-1A2-MM

Molecular formula: C<sub>9</sub>H<sub>19</sub>N<sub>2</sub>O<sub>2</sub>P

CAS Index Name:

**IUPAC name:**

Synonyms:

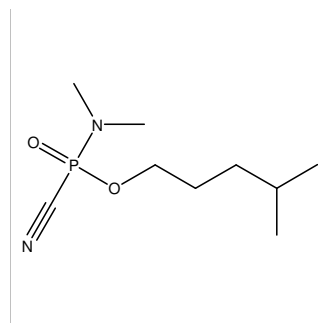

**Chemical name:** 4-Methylpentyl N,N-dipropylphosphoramidocyanidate

Schedule: 1A02

CAS RN:

HS code: 2931.39

Key: (626-89-1)-1A2-PP

Molecular formula: C<sub>13</sub>H<sub>27</sub>N<sub>2</sub>O<sub>2</sub>P

CAS Index Name:

**IUPAC name:**

Synonyms:

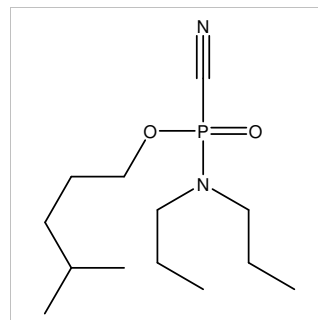

**Chemical name:** 1-Methylpentyl N-ethyl-N-isopropylphosphoramidocyanidate

Schedule: 1A02

CAS RN:

HS code: 2931.39

Key: (626-93-7)-1A2-EI

Molecular formula: C<sub>12</sub>H<sub>25</sub>N<sub>2</sub>O<sub>2</sub>P

CAS Index Name:

**IUPAC name:**

Synonyms:

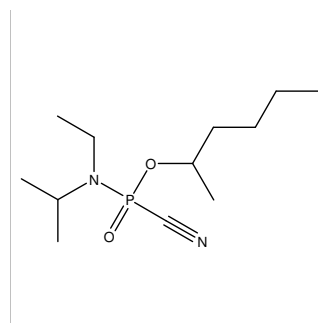

**Chemical name:** 1-Methylpentyl N-ethyl-N-methylphosphoramidocyanidate

Schedule: 1A02

CAS RN: HS code: 2931.39

Key: (626-93-7)-1A2-EM

Molecular formula: C<sub>10</sub>H<sub>21</sub>N<sub>2</sub>O<sub>2</sub>P

CAS Index Name: Phosphoramidocyanidic acid, ethylmethyl-, 1-methylpentyl ester

**IUPAC name:** 1-Methylpentyl ethylmethylphosphoramidocyanidoate

Synonyms: O-1-Methylpentyl N-ethyl-N-methylphosphoramidocyanidate

Hexan-2-yl N-ethyl-N-methylphosphoramidocyanidate

Hex-2-yl N-ethyl-N-methylphosphoramidocyanidate

1-Methylpentyl ethyl(methyl)amidocyanidophosphate

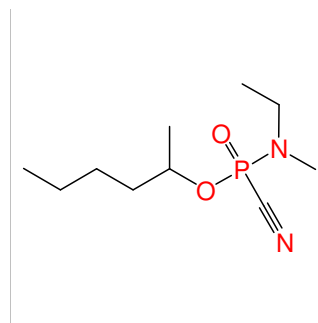

**Chemical name:** 1-Methylpentyl N-ethyl-N-propylphosphoramidocyanidate

Schedule: 1A02

CAS RN: HS code: 2931.39

Key: (626-93-7)-1A2-EP

Molecular formula: C<sub>12</sub>H<sub>25</sub>N<sub>2</sub>O<sub>2</sub>P

CAS Index Name:

**IUPAC name:**

Synonyms:

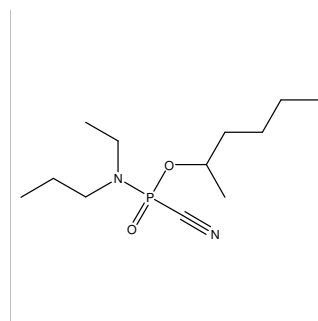

**Chemical name:** 1-Methylpentyl N,N-diisopropylphosphoramidocyanidate

Schedule: 1A02

CAS RN: HS code: 2931.39

Key: (626-93-7)-1A2-II

Molecular formula: C<sub>13</sub>H<sub>27</sub>N<sub>2</sub>O<sub>2</sub>P

CAS Index Name:

**IUPAC name:**

Synonyms:

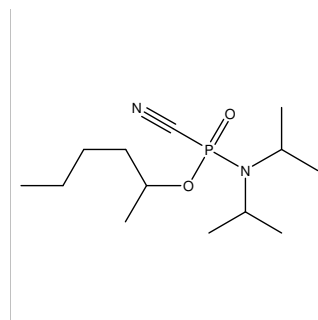

**Chemical name:** 1-Methylpentyl N-isopropyl-N-methylphosphoramidocyanidate

Schedule: 1A02

CAS RN: HS code: 2931.39

Key: (626-93-7)-1A2-IM

Molecular formula: C<sub>11</sub>H<sub>23</sub>N<sub>2</sub>O<sub>2</sub>P

CAS Index Name:

**IUPAC name:**

Synonyms:

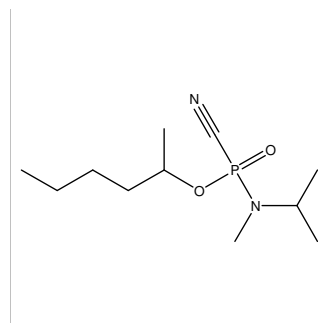

**Chemical name:** 1-Methylpentyl N-methyl-N-propylphosphoramidocyanidate

Schedule: 1A02

CAS RN: HS code: 2931.39

Key: (626-93-7)-1A2-MP

Molecular formula: C<sub>11</sub>H<sub>23</sub>N<sub>2</sub>O<sub>2</sub>P

CAS Index Name:

**IUPAC name:**

Synonyms:

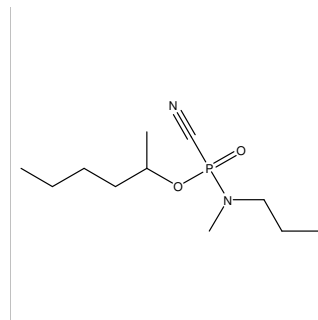

**Chemical name:** 1-Methylpentyl N,N-dipropylphosphoramidocyanidate

Schedule: 1A02

CAS RN: HS code: 2931.39

Key: (626-93-7)-1A2-PP

Molecular formula: C<sub>13</sub>H<sub>27</sub>N<sub>2</sub>O<sub>2</sub>P

CAS Index Name:

**IUPAC name:**

Synonyms:

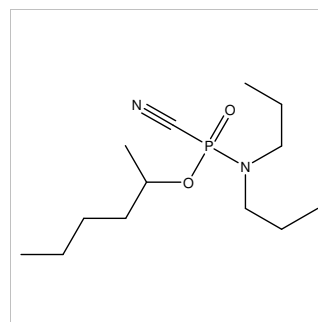

**Chemical name:** 1,4-Dimethylpentyl N-ethyl-N-isopropylphosphoramidocyanidate

Schedule: 1A02

CAS RN: HS code: 2931.39

Key: (627-59-8)-1A2-EI

Molecular formula: C<sub>13</sub>H<sub>27</sub>N<sub>2</sub>O<sub>2</sub>P

CAS Index Name:

**IUPAC name:**

Synonyms:

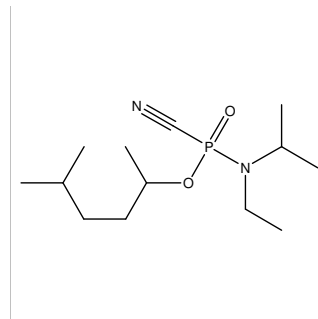

**Chemical name:** 1,4-Dimethylpentyl N-ethyl-N-propylphosphoramidocyanidate

Schedule: 1A02

CAS RN: HS code: 2931.39

Key: (627-59-8)-1A2-EP

Molecular formula: C<sub>13</sub>H<sub>27</sub>N<sub>2</sub>O<sub>2</sub>P

CAS Index Name:

**IUPAC name:**

Synonyms:

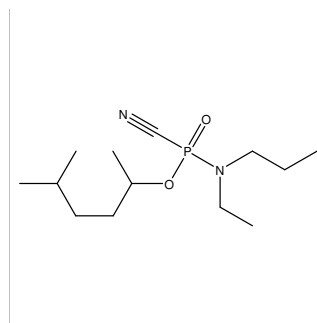

**Chemical name:** 1,4-Dimethylpentyl N,N-dimethylphosphoramidocyanidate

Schedule: 1A02

CAS RN: HS code: 2931.39

Key: (627-59-8)-1A2-MM

Molecular formula: C<sub>10</sub>H<sub>21</sub>N<sub>2</sub>O<sub>2</sub>P

CAS Index Name:

**IUPAC name:**

Synonyms:

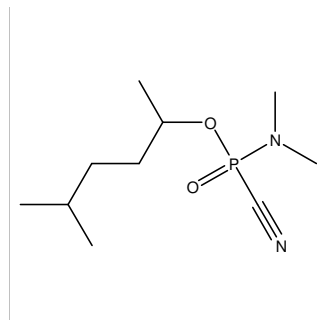

**Chemical name:** 5-Methylhexyl N,N-dimethylphosphoramidocyanidate

Schedule: 1A02

CAS RN: HS code: 2931.39

Key: (627-98-5)-1A2-MM

Molecular formula: C<sub>10</sub>H<sub>21</sub>N<sub>2</sub>O<sub>2</sub>P

CAS Index Name:

**IUPAC name:**

Synonyms:

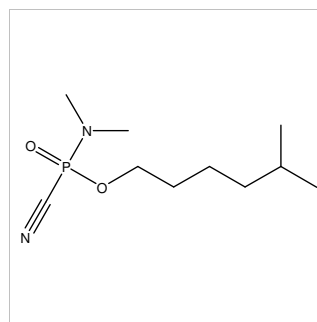

**Chemical name:** 1-Methyloctyl N,N-dimethylphosphoramidocyanidate

Schedule: 1A02

CAS RN: HS code: 2931.39

Key: (628-99-9)-1A2-MM

Molecular formula: C<sub>12</sub>H<sub>25</sub>N<sub>2</sub>O<sub>2</sub>P

CAS Index Name:

**IUPAC name:**

Synonyms:

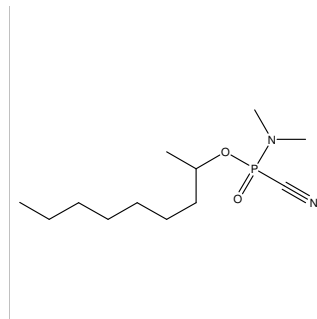

**Chemical name:** 1,1-Diethyl-2,2-dimethylpropyl N,N-dimethylphosphoramidocyanidate

Schedule: 1A02

CAS RN: HS code: 2931.39

Key: (66793-96-2)-1A2-MM

Molecular formula: C<sub>12</sub>H<sub>25</sub>N<sub>2</sub>O<sub>2</sub>P

CAS Index Name: Phosphoramidocyanidic acid, dimethyl-, 1,1-diethyl-2,2-dimethylpropyl ester

**IUPAC name:** 1,1-Diethyl-2,2-dimethylpropyl dimethylphosphoramidocyanidoate

Synonyms: O-1,1-Diethyl-2,2-dimethylpropyl N,N-dimethylphosphoramidocyanidate

1,1-Diethyl-2,2-dimethylpropyl dimethylamidocyanidophosphate

3-Ethyl-2,2-dimethyl-3-pentyl N,N-dimethylphosphoramidocyanidate

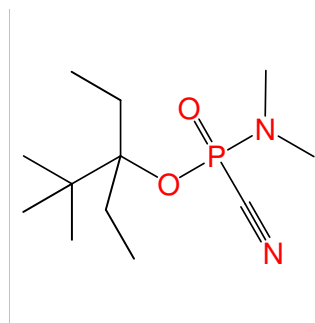

**Chemical name:** Pentyl N,N-diethylphosphoramidocyanidate

Schedule: 1A02

CAS RN: HS code: 2931.39

Key: (71-41-0)-1A1-EE

Molecular formula: C<sub>10</sub>H<sub>21</sub>N<sub>2</sub>O<sub>2</sub>P

CAS Index Name: Phosphoramidocyanidic acid, diethyl-, pentyl ester

**IUPAC name:** Pentyl diethylphosphoramidocyanidoate

Synonyms: Pentyl diethylamidocyanidophosphate

O-Pentyl N,N-diethylphosphoramidocyanidate

n-Pentyl N,N-diethylphosphoramidocyanidate

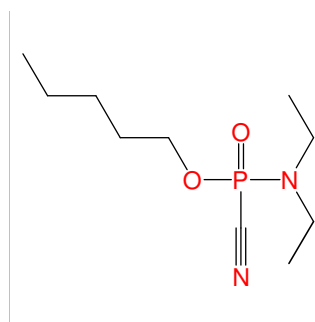

**Chemical name:** Pentyl N-methyl-N-propylphosphoramidocyanidate

Schedule: 1A02

CAS RN: HS code: 2931.39

Key: (71-41-0)-1A2-MP

Molecular formula: C<sub>10</sub>H<sub>21</sub>N<sub>2</sub>O<sub>2</sub>P

CAS Index Name: Phosphoramidocyanidic acid, methylpropyl-, pentyl ester

**IUPAC name:** Pentyl methylpropylphosphoramidocyanidoate

Synonyms: Pentyl methylpropylamidocyanidophosphate

Pentyl methyl(propyl)amidocyanidophosphate

O-Pentyl N-methyl-N-propylphosphoramidocyanidate

n-Pentyl N-methyl-N-propylphosphoramidocyanidate

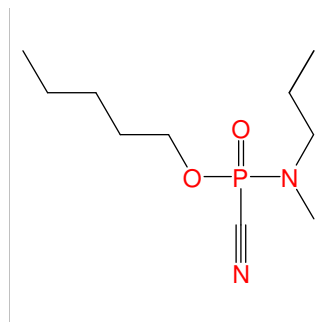

**Chemical name:** tert-Butyl N,N-dimethylphosphoramidocyanidate

Schedule: 1A02

CAS RN: HS code: 2931.39

Key: (75-65-0)-1A2-MM

Molecular formula: C<sub>7</sub>H<sub>15</sub>N<sub>2</sub>O<sub>2</sub>P

CAS Index Name: Phosphoramidocyanidic acid, dimethyl-, tert-butyl ester

**IUPAC name:** tert-Butyl dimethylphosphoramidocyanidoate

Synonyms: tert-Butyl dimethylamidocyanidophosphate

t-Butyl N,N-dimethylphosphoramidocyanidate

O-tert-Butyl N,N-dimethylphosphoramidocyanidate

2-Methylpropan-2-yl N,N-dimethylphosphoramidocyanidate

2-Methylprop-2-yl N,N-dimethylphosphoramidocyanidate

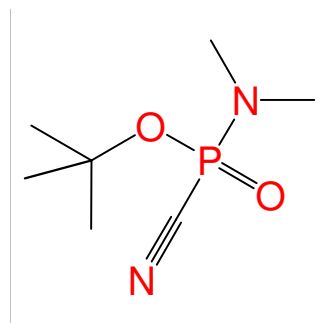

**Chemical name:** 2,2-Dimethylpropyl N,N-dimethylphosphoramidocyanidate

Schedule: 1A02

CAS RN: HS code: 2931.39

Key: (75-84-3)-1A2-MM

Molecular formula: C<sub>8</sub>H<sub>17</sub>N<sub>2</sub>O<sub>2</sub>P

CAS Index Name:

**IUPAC name:**

Synonyms:

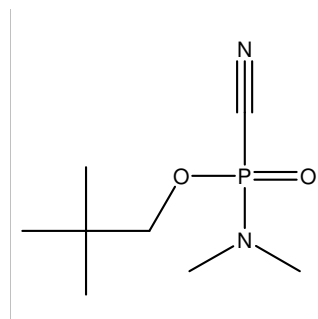

**Chemical name:** 1,1-Dimethylpropyl N,N-dimethylphosphoramidocyanidate

Schedule: 1A02

CAS RN: HS code: 2931.39

Key: (75-85-4)-1A2-MM

Molecular formula: C<sub>8</sub>H<sub>17</sub>N<sub>2</sub>O<sub>2</sub>P

CAS Index Name: Phosphoramidocyanidic acid, dimethyl-, 1,1-dimethylpropyl ester

**IUPAC name:** 1,1-Dimethylpropyl dimethylphosphoramidocyanidoate

Synonyms: O-1,1-Dimethylpropyl N,N-dimethylphosphoramidocyanidate

2-Methylbutan-2-yl N,N-dimethylphosphoramidocyanidate

2-Methylbut-2-yl N,N-dimethylphosphoramidocyanidate

1,1-Dimethylpropyl N,N-dimethylamidocyanidophosphate

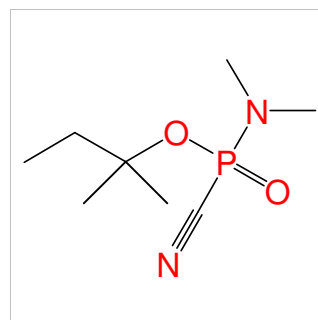



**Chemical name:** 3-Cyclopentylpropyl N,N-diethylphosphoramidocyanidate

Schedule: 1A02

CAS RN: HS code: 2931.39

Key: (767-05-5)-1A2-EE

Molecular formula: C<sub>13</sub>H<sub>25</sub>N<sub>2</sub>O<sub>2</sub>P

CAS Index Name:

**IUPAC name:**

Synonyms:

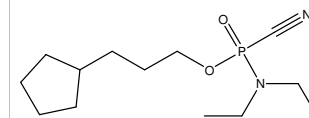

**Chemical name:** 3-Cyclopentylpropyl N,N-diisopropylphosphoramidocyanidate

Schedule: 1A02

CAS RN: HS code: 2931.39

Key: (767-05-5)-1A2-II

Molecular formula: C<sub>15</sub>H<sub>29</sub>N<sub>2</sub>O<sub>2</sub>P

CAS Index Name:

**IUPAC name:**

Synonyms:

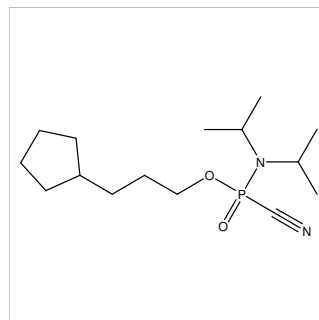

**Chemical name:** 3-Cyclopentylpropyl N,N-dimethylphosphoramidocyanidate

Schedule: 1A02

CAS RN: HS code: 2931.39

Key: (767-05-5)-1A2-MM

Molecular formula: C<sub>11</sub>H<sub>21</sub>N<sub>2</sub>O<sub>2</sub>P

CAS Index Name:

**IUPAC name:**

Synonyms:

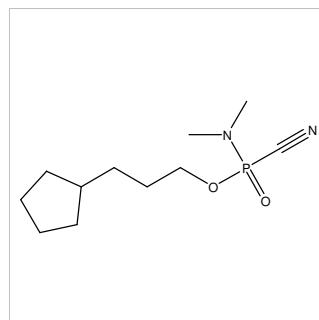

**Chemical name:** 3-Cyclopentylpropyl N,N-dipropylphosphoramidocyanidate

Schedule: 1A02

CAS RN: HS code: 2931.39

Key: (767-05-5)-1A2-PP

Molecular formula: C<sub>15</sub>H<sub>29</sub>N<sub>2</sub>O<sub>2</sub>P

CAS Index Name:

**IUPAC name:**

Synonyms:

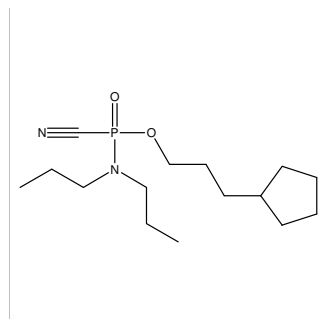

**Chemical name:** 1-Ethyl-1-methylpropyl N,N-dimethylphosphoramidocyanidate

Schedule: 1A02

CAS RN: HS code: 2931.39

Key: (77-74-7)-1A2-MM

Molecular formula: C<sub>9</sub>H<sub>19</sub>N<sub>2</sub>O<sub>2</sub>P

CAS Index Name: Phosphoramidocyanidic acid, dimethyl-, 1-ethyl-1-methylpropyl ester

**IUPAC name:** 1-Ethyl-1-methylpropyl dimethylphosphoramidocyanidoate

Synonyms: O-1-Ethyl-1-methylpropyl N,N-dimethylphosphoramidocyanidate

3-Methylpentan-3-yl N,N-dimethylphosphoramidocyanidate

3-Methylpent-3-yl N,N-dimethylphosphoramidocyanidate

1-Ethyl-1-methylpropyl dimethylamidocyanidophosphate

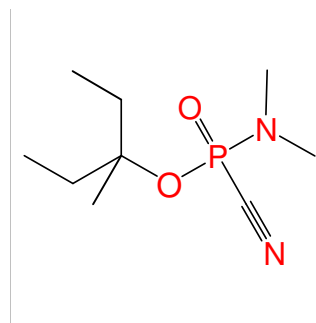

**Chemical name:** sec-Butyl N-ethyl-N-propylphosphoramidocyanidate

Schedule: 1A02

CAS RN: HS code: 2931.39

Key: (78-92-2)-1A2-EP

Molecular formula: C<sub>10</sub>H<sub>21</sub>N<sub>2</sub>O<sub>2</sub>P

CAS Index Name: Phosphoramidocyanidic acid, ethylpropyl-, 1-methylpropyl ester

**IUPAC name:** sec-Butyl ethylpropylphosphoramidocyanidoate

Synonyms: sec-Butyl ethyl(propyl)amidocyanidophosphate

Phosphoramidocyanidic acid, N-ethyl-N-propyl-, 1-methylpropyl ester

O-sec-Butyl N-ethyl-N-propylphosphoramidocyanidate

Butan-2-yl N-ethyl-N-propylphosphoramidocyanidate

But-2-yl N-ethyl-N-propylphosphoramidocyanidate

1-Methylpropyl N-ethyl-N-propylphosphoramidocyanidate

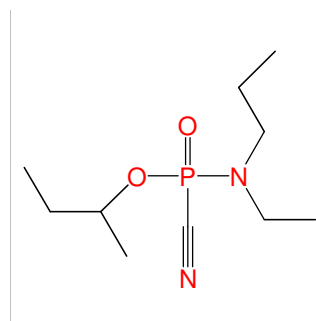

**Chemical name:** 2-Isopropyl-5-methylcyclohexyl N,N-dimethylphosphoramidocyanidate

Schedule: 1A02

CAS RN: HS code: 2931.39

Key: (89-78-1)-1A2-MM

Molecular formula: C<sub>13</sub>H<sub>25</sub>N<sub>2</sub>O<sub>2</sub>P

CAS Index Name:

**IUPAC name:**

Synonyms:

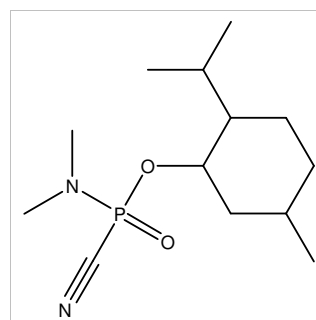

**Chemical name:** Cyclopentyl N,N-diethylphosphoramidocyanidate

Schedule: 1A02

CAS RN: HS code: 2931.39

Key: (96-41-3)-1A2-EE

Molecular formula: C<sub>10</sub>H<sub>19</sub>N<sub>2</sub>O<sub>2</sub>P

CAS Index Name:

**IUPAC name:**

Synonyms:

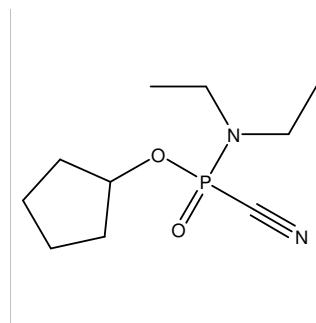

**Chemical name:** Cyclopentyl N-ethyl-N-isopropylphosphoramidocyanidate

Schedule: 1A02

CAS RN: HS code: 2931.39

Key: (96-41-3)-1A2-EI

Molecular formula: C<sub>11</sub>H<sub>21</sub>N<sub>2</sub>O<sub>2</sub>P

CAS Index Name:

**IUPAC name:**

Synonyms:

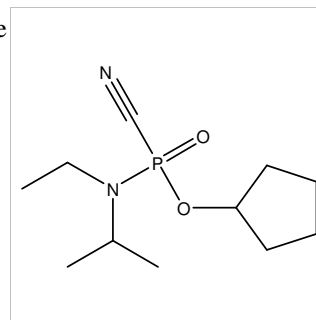

**Chemical name:** Cyclopentyl N-ethyl-N-methylphosphoramidocyanidate

Schedule: 1A02

CAS RN: HS code: 2931.39

Key: (96-41-3)-1A2-EM

Molecular formula: C<sub>9</sub>H<sub>17</sub>N<sub>2</sub>O<sub>2</sub>P

CAS Index Name:

**IUPAC name:**

Synonyms:

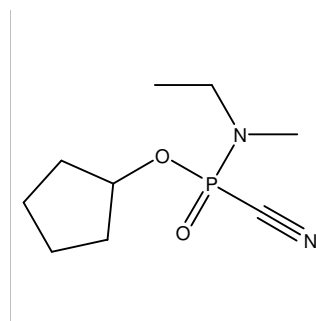

**Chemical name:** Cyclopentyl N-ethyl-N-propylphosphoramidocyanidate

Schedule: 1A02

CAS RN: HS code: 2931.39

Key: (96-41-3)-1A2-EP

Molecular formula: C<sub>11</sub>H<sub>21</sub>N<sub>2</sub>O<sub>2</sub>P

CAS Index Name:

**IUPAC name:**

Synonyms:

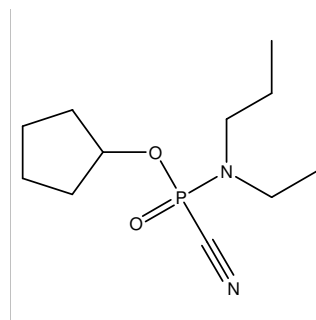

**Chemical name:** Cyclopentyl N,N-diisopropylphosphoramidocyanidate

Schedule: 1A02

CAS RN:

HS code: 2931.39

Key: (96-41-3)-1A2-II

Molecular formula: C<sub>12</sub>H<sub>23</sub>N<sub>2</sub>O<sub>2</sub>P

CAS Index Name:

**IUPAC name:**

Synonyms:

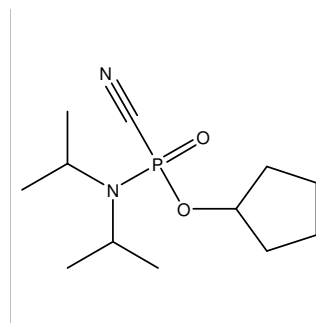

**Chemical name:** Cyclopentyl N-isopropyl-N-methylphosphoramidocyanidate

Schedule: 1A02

CAS RN:

HS code: 2931.39

Key: (96-41-3)-1A2-IM

Molecular formula: C<sub>10</sub>H<sub>19</sub>N<sub>2</sub>O<sub>2</sub>P

CAS Index Name:

**IUPAC name:**

Synonyms:

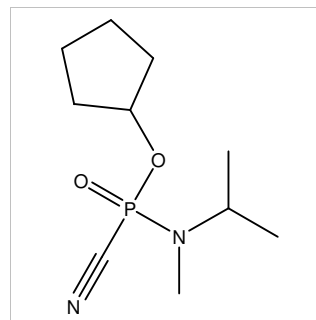

**Chemical name:** Cyclopentyl N,N-dimethylphosphoramidocyanidate

Schedule: 1A02

CAS RN:

HS code: 2931.39

Key: (96-41-3)-1A2-MM

Molecular formula: C<sub>8</sub>H<sub>15</sub>N<sub>2</sub>O<sub>2</sub>P

CAS Index Name:

**IUPAC name:**

Synonyms:

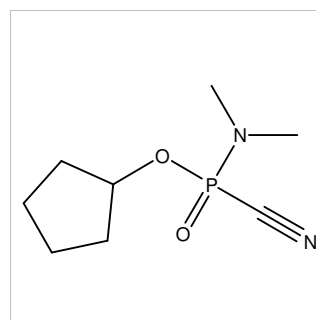

**Chemical name:** Cyclopentyl N-methyl-N-propylphosphoramidocyanidate

Schedule: 1A02

CAS RN:

HS code: 2931.39

Key: (96-41-3)-1A2-MP

Molecular formula: C<sub>10</sub>H<sub>19</sub>N<sub>2</sub>O<sub>2</sub>P

CAS Index Name:

**IUPAC name:**

Synonyms:

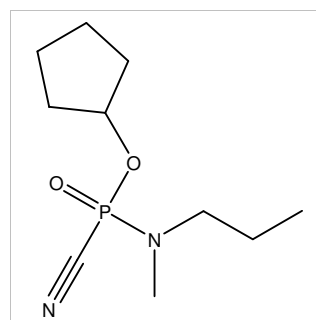

**Chemical name:** 2-Ethylbutyl N,N-dimethylphosphoramidocyanidate

Schedule: 1A02

CAS RN: HS code: 2931.39

Key: (97-95-0)-1A2-MM

Molecular formula: C<sub>9</sub>H<sub>19</sub>N<sub>2</sub>O<sub>2</sub>P

CAS Index Name:

**IUPAC name:**

Synonyms:

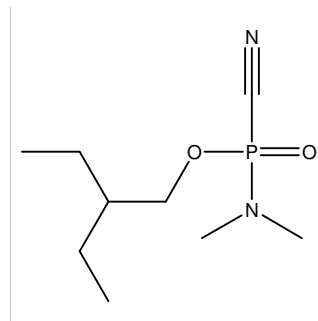

**Chemical name:** 4-tert-Butylcyclohexyl N,N-dimethylphosphoramidocyanidate

Schedule: 1A02

CAS RN: HS code: 2931.39

Key: (98-52-2)-1A2-MM

Molecular formula: C<sub>13</sub>H<sub>25</sub>N<sub>2</sub>O<sub>2</sub>P

CAS Index Name:

**IUPAC name:**

Synonyms:

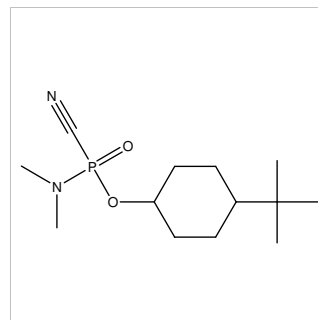

**Chemical name:** 1-Methylpentyl N,N-diethylphosphoramidocyanidate

Schedule: 1A02

CAS RN: 1252610-35-7 HS code: 2931.39

Key: 1252610-35-7

Molecular formula: C<sub>11</sub>H<sub>23</sub>N<sub>2</sub>O<sub>2</sub>P

CAS Index Name: Phosphoramidocyanidic acid, N,N-diethyl-, 1-methylpentyl ester

**IUPAC name:**

Synonyms:

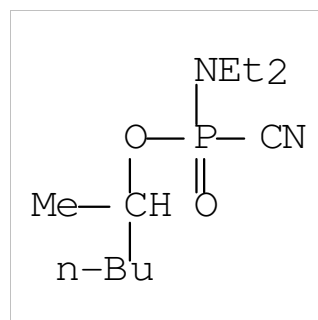

**Chemical name:** 1-Isopropyl-2-methylpropyl N-isopropyl-N-propylphosphoramidocyanidate

Schedule: 1A02

CAS RN: 1252610-36-8

HS code: 2931.39

Key: 1252610-36-8

Molecular formula: C<sub>14</sub>H<sub>29</sub>N<sub>2</sub>O<sub>2</sub>P

CAS Index Name: Phosphoramidocyanidic acid, (1-methylethyl)propyl-, 1-(1-methylethyl)-2-methylpropyl ester

**IUPAC name:** 1-Isopropyl-2-methylpropyl isopropylpropylphosphoramidocyanidoate

**Synonyms:** Phosphoramidocyanidic acid, N-1-methylethyl-N-propyl-, 2,4-dimethylpent-3-yl ester  
O-1-Isopropyl-2-methylpropyl N-isopropyl-N-propylphosphoramidocyanidate  
2,4-Dimethylpentan-3-yl N-isopropyl-N-propylphosphoramidocyanidate  
2,4-Dimethylpent-3-yl N-isopropyl-N-propylphosphoramidocyanidate  
1-Isopropylisobutyl N-isopropyl-N-propylphosphoramidocyanidate  
1-Isopropyl-2-methylpropyl isopropyl(propyl)amidocyanidophosphate  
1-(1-methylethyl)-2-methylpropyl N-isopropyl-N-propylphosphoramidocyanidate

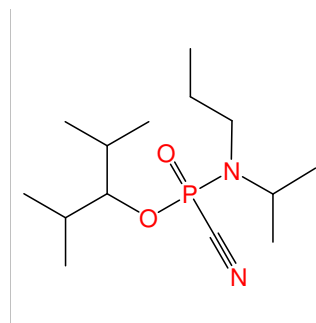

**Chemical name:** Isopropyl N,N-diisopropylphosphoramidocyanidate

Schedule: 1A02

CAS RN: 1252610-37-9

HS code: 2931.39

Key: 1252610-37-9

Molecular formula: C<sub>10</sub>H<sub>21</sub>N<sub>2</sub>O<sub>2</sub>P

CAS Index Name: Phosphoramidocyanidic acid, bis(1-methylethyl)-, 1-methylethyl ester

**IUPAC name:** Isopropyl diisopropylphosphoramidocyanidoate

**Synonyms:** Phosphoramidocyanidic acid, bis(N-1-methylethyl)-, 1-methylethyl ester  
O-Isopropyl N,N-diisopropylphosphoramidocyanidate  
Isopropyl diisopropylamidocyanidophosphate

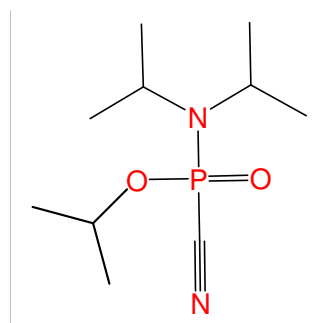

**Chemical name:** 2,6-Dimethylcyclohexyl N,N-dipropylphosphoramidocyanidate

Schedule: 1A02

CAS RN: 1252610-38-0

HS code: 2931.39

Key: 1252610-38-0

Molecular formula: C<sub>15</sub>H<sub>29</sub>N<sub>2</sub>O<sub>2</sub>P

CAS Index Name: Phosphoramidocyanidic acid, dipropyl-, 2,6-dimethylcyclohexyl ester

**IUPAC name:** 2,6-Dimethylcyclohexyl dipropylphosphoramidocyanidoate

**Synonyms:** Phosphoramidocyanidic acid, N,N-dipropyl-, 2,6-dimethylcyclohexyl ester  
O-2,6-Dimethylcyclohexyl N,N-dipropylphosphoramidocyanidate  
2,6-Dimethylcyclohexyl dipropylamidocyanidophosphate

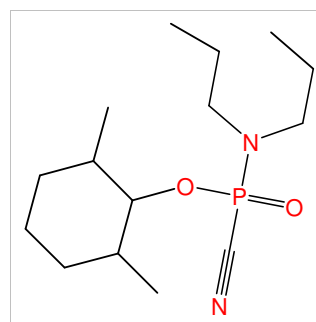

**Chemical name:** Cyclohexyl N-isopropyl-N-propylphosphoramidocyanidate

Schedule: 1A02

CAS RN: 1253782-35-2

HS code: 2931.39

Key: 1253782-35-2

Molecular formula: C<sub>13</sub>H<sub>25</sub>N<sub>2</sub>O<sub>2</sub>P

CAS Index Name: Phosphoramidocyanidic acid, (1-methylethyl)propyl-, cyclohexyl ester

**IUPAC name:** Cyclohexyl isopropylpropylphosphoramidocyanidoate

Synonyms: Phosphoramidocyanidic acid, N-1-methylethyl-N-propyl-, cyclohexyl ester

O-Cyclohexyl N-isopropyl-N-propylphosphoramidocyanidate

Cyclohexyl isopropyl(propyl)amidocyanidophosphate

Cyclohexyl (1-methylethyl)(propyl)amidocyanidophosphate

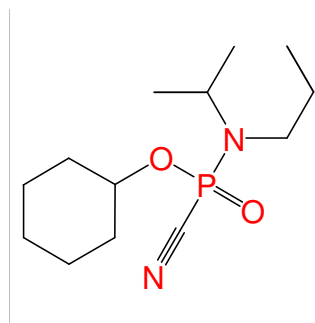

**Chemical name:** Octyl N,N-dimethylphosphoramidocyanidate

Schedule: 1A02

CAS RN: 1253782-45-4

HS code: 2931.39

Key: 1253782-45-4

Molecular formula: C<sub>11</sub>H<sub>23</sub>N<sub>2</sub>O<sub>2</sub>P

CAS Index Name: Phosphoramidocyanidic acid, dimethyl-, octyl ester

**IUPAC name:** Octyl dimethylphosphoramidocyanidoate

Synonyms: Phosphoramidocyanidic acid, N,N-dimethyl-, octyl ester

Octyl dimethylamidocyanidophosphate

O-Octyl N,N-dimethylphosphoramidocyanidate

n-Octyl N,N-dimethylphosphoramidocyanidate

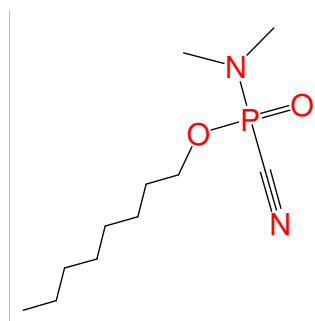

**Chemical name:** 1-Ethylhexyl N,N-dimethylphosphoramidocyanidate

Schedule: 1A02

CAS RN: 1253782-49-8

HS code: 2931.39

Key: 1253782-49-8

Molecular formula: C<sub>11</sub>H<sub>23</sub>N<sub>2</sub>O<sub>2</sub>P

CAS Index Name: Phosphoramidocyanidic acid, dimethyl-, 1-ethylhexyl ester

**IUPAC name:** 1-Ethylhexyl dimethylphosphoramidocyanidoate

Synonyms: Phosphoramidocyanidic acid, N,N-dimethyl-, 1-ethylhexyl ester

Octan-3-yl N,N-dimethylphosphoramidocyanidate

Oct-3-yl N,N-dimethylphosphoramidocyanidate

O-1-Ethylhexyl N,N-dimethylphosphoramidocyanidate

1-Ethylhexyl dimethylamidocyanidophosphate

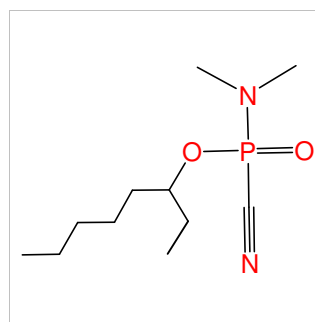

**Chemical name:** 1,1,2-Trimethylpropyl N,N-dipropylphosphoramidocyanidate

Schedule: 1A02

CAS RN: 1253782-51-2 HS code: 2931.39

Key: 1253782-51-2

Molecular formula: C<sub>13</sub>H<sub>27</sub>N<sub>2</sub>O<sub>2</sub>P

CAS Index Name: Phosphoramidocyanidic acid, N,N-dipropyl-, 1,1,2-trimethylpropyl ester

**IUPAC name:**

Synonyms:

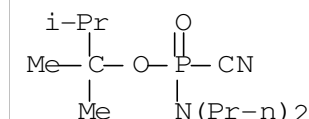

**Chemical name:** Isopropyl N-ethyl-N-isopropylphosphoramidocyanidate

Schedule: 1A02

CAS RN: 1253782-69-2 HS code: 2931.39

Key: 1253782-69-2

Molecular formula: C<sub>9</sub>H<sub>19</sub>N<sub>2</sub>O<sub>2</sub>P

CAS Index Name: Phosphoramidocyanidic acid, ethyl(1-methylethyl)-, 1-methylethyl ester

**IUPAC name:** Isopropyl ethylisopropylphosphoramidocyanidoate

Synonyms: Phosphoramidocyanidic acid, N-ethyl-N-1-methylethyl-, 1-methylethyl ester

O-Isopropyl N-ethyl-N-isopropylphosphoramidocyanidate

Isopropyl ethyl(isopropyl)amidocyanidophosphate

Isopropyl ethyl(1-methylethyl)amidocyanidophosphate

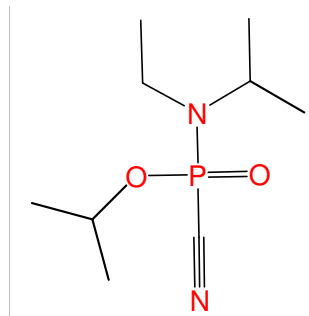

**Chemical name:** Butyl N,N-diisopropylphosphoramidocyanidate

Schedule: 1A02

CAS RN: 1253782-71-6 HS code: 2931.39

Key: 1253782-71-6

Molecular formula: C<sub>11</sub>H<sub>23</sub>N<sub>2</sub>O<sub>2</sub>P

CAS Index Name: Phosphoramidocyanidic acid, bis(1-methylethyl)-, butyl ester

**IUPAC name:** Butyl diisopropylphosphoramidocyanidoate

Synonyms: Phosphoramidocyanidic acid, bis(N-1-methylethyl)-, butyl ester

O-Butyl N,N-diisopropylphosphoramidocyanidate

n-Butyl N,N-diisopropylphosphoramidocyanidate

Butyl diisopropylamidocyanidophosphate

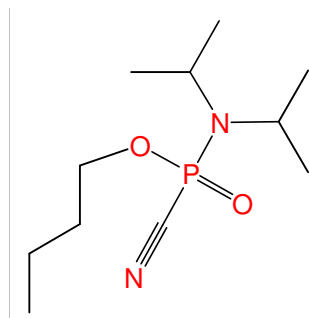



**Chemical name:** Butyl N-methyl-N-propylphosphoramidocyanidate

Schedule: 1A02

CAS RN: 1253782-74-9

HS code: 2931.39

Key: 1253782-74-9

Molecular formula: C<sub>9</sub>H<sub>19</sub>N<sub>2</sub>O<sub>2</sub>P

CAS Index Name: Phosphoramidocyanidic acid, methylpropyl-, butyl ester

**IUPAC name:** Butyl methylpropylphosphoramidocyanidoate

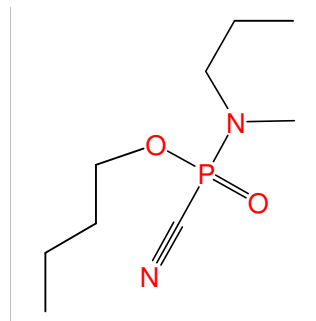

Synonyms: Phosphoramidocyanidic acid, N-methyl-N-propyl-, butyl ester

O-Butyl N-methyl-N-propylphosphoramidocyanidate

n-Butyl N-methyl-N-propylphosphoramidocyanidate

Butyl methyl(propyl)amidocyanidophosphate

**Chemical name:** 2,2-Dimethylpropyl N,N-diisopropylphosphoramidocyanidate

Schedule: 1A02

CAS RN: 1253782-83-0

HS code: 2931.39

Key: 1253782-83-0

Molecular formula: C<sub>12</sub>H<sub>25</sub>N<sub>2</sub>O<sub>2</sub>P

CAS Index Name: Phosphoramidocyanidic acid, bis(1-methylethyl)-, 2,2-dimethylpropyl ester

**IUPAC name:** 2,2-Dimethylpropyl diisopropylphosphoramidocyanidoate

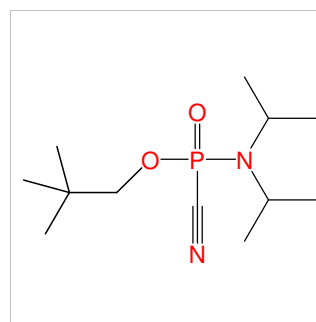

Synonyms: Phosphoramidocyanidic acid, bis-(N-1-methylethyl)-, 2,2-dimethylpropyl ester

O-2,2-Dimethylpropyl N,N-diisopropylphosphoramidocyanidate

Neopentyl N,N-diisopropylphosphoramidocyanidate

2,2-Dimethylpropyl diisopropylamidocyanidophosphate

**Chemical name:** 2,2-Dimethylpropyl N-isopropyl-N-propylphosphoramidocyanidate

Schedule: 1A02

CAS RN: 1253782-84-1

HS code: 2931.39

Key: 1253782-84-1

Molecular formula: C<sub>12</sub>H<sub>25</sub>N<sub>2</sub>O<sub>2</sub>P

CAS Index Name: Phosphoramidocyanidic acid, (1-methylethyl)propyl-, 2,2-dimethylpropyl ester

**IUPAC name:** 2,2-Dimethylpropyl isopropylpropylphosphoramidocyanidoate

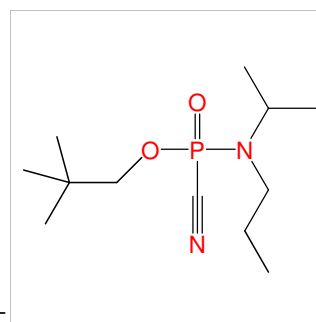

Synonyms: Phosphoramidocyanidic acid, N-1-methylethyl-N-propyl-, 2,2-dimethylpropyl ester

O-2,2-Dimethylpropyl N-isopropyl-N-propylphosphoramidocyanidate

Neopentyl N-isopropyl-N-propylphosphoramidocyanidate

2,2-Dimethylpropyl isopropyl(propyl)amidocyanidophosphate

**Chemical name:** Isobutyl N,N-diethylphosphoramidocyanidate

Schedule: 1A02

CAS RN: 1253782-85-2

HS code: 2931.39

Key: 1253782-85-2

Molecular formula: C<sub>9</sub>H<sub>19</sub>N<sub>2</sub>O<sub>2</sub>P

CAS Index Name: Phosphoramidocyanidic acid, diethyl-, 2-methylpropyl ester

**IUPAC name:** Isobutyl diethylphosphoramidocyanidoate

Synonyms: Phosphoramidocyanidic acid, N,N-diethyl-, 2-methylpropyl ester

O-Isobutyl N,N-diethylphosphoramidocyanidate

O-2-Methylpropyl N,N-diethylphosphoramidocyanidate

Isobutyl diethylamidocyanidophosphate

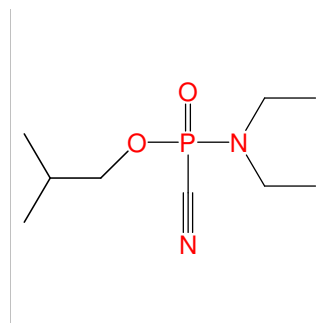

**Chemical name:** Isobutyl N-methyl-N-propylphosphoramidocyanidate

Schedule: 1A02

CAS RN: 1253782-86-3

HS code: 2931.39

Key: 1253782-86-3

Molecular formula: C<sub>9</sub>H<sub>19</sub>N<sub>2</sub>O<sub>2</sub>P

CAS Index Name: Phosphoramidocyanidic acid, methylpropyl-, 2-methylpropyl ester

**IUPAC name:** Isobutyl methylpropylphosphoramidocyanidoate

Synonyms: Phosphoramidocyanidic acid, N-methyl-N-propyl-, 2-methylpropyl ester

O-Isobutyl N-methyl-N-propylphosphoramidocyanidate

O-2-Methylpropyl N-methyl-N-propylphosphoramidocyanidate

Isobutyl methyl(propyl)amidocyanidophosphate

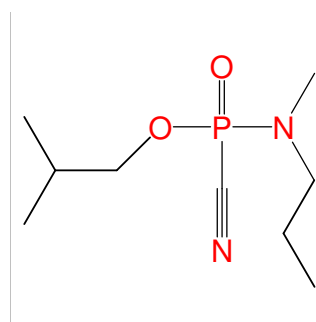

**Chemical name:** 1-Methylheptyl N,N-diisopropylphosphoramidocyanidate

Schedule: 1A02

CAS RN: 1254103-95-1

HS code: 2931.39

Key: 1254103-95-1

Molecular formula: C<sub>15</sub>H<sub>31</sub>N<sub>2</sub>O<sub>2</sub>P

CAS Index Name: Phosphoramidocyanidic acid, bis(1-methylethyl)-, 1-methylheptyl ester

**IUPAC name:** 1-Methylheptyl diisopropylphosphoramidocyanidoate

Synonyms: Phosphoramidocyanidic acid, bis(N-1-methylethyl)-, 1-methylheptyl ester

Phosphoramidocyanidic acid, bis(1-methylethyl)-, oct-2-yl ester

Octan-2-yl N,N-diisopropylphosphoramidocyanidate

Oct-2-yl N,N-diisopropylphosphoramidocyanidate

O-1-Methylheptyl N,N-diisopropylphosphoramidocyanidate

1-Methylheptyl diisopropylamidocyanidophosphate

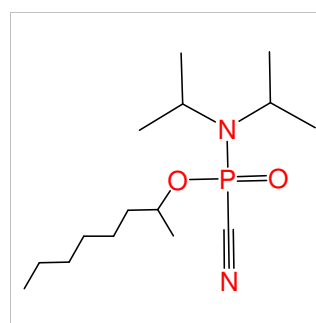

**Chemical name:** Propyl N,N-diethylphosphoramidocyanidate

Schedule: 1A02

CAS RN: 1256571-92-2

HS code: 2931.39

Key: 1256571-92-2

Molecular formula: C<sub>8</sub>H<sub>17</sub>N<sub>2</sub>O<sub>2</sub>P

CAS Index Name: Phosphoramidocyanidic acid, diethyl-, propyl ester

**IUPAC name:** Propyl diethylphosphoramidocyanidoate

Synonyms: Propyl diethylamidocyanidophosphate

Phosphoramidocyanidic acid, N,N-diethyl-, propyl ester

O-Propyl N,N-diethylphosphoramidocyanidate

O-n-Propyl N,N-diethylphosphoramidocyanidate

n-Propyl N,N-diethylphosphoramidocyanidate

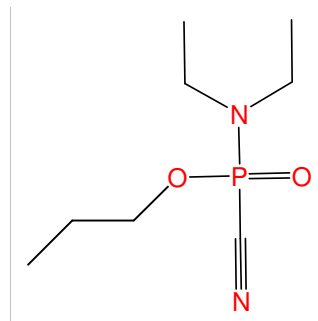

**Chemical name:** Propyl N-ethyl-N-isopropylphosphoramidocyanidate

Schedule: 1A02

CAS RN: 1256571-93-3

HS code: 2931.39

Key: 1256571-93-3

Molecular formula: C<sub>9</sub>H<sub>19</sub>N<sub>2</sub>O<sub>2</sub>P

CAS Index Name: Phosphoramidocyanidic acid, ethyl(1-methylethyl)-, propyl ester

**IUPAC name:** Propyl ethylisopropylphosphoramidocyanidoate

Synonyms: Propyl ethyl(isopropyl)amidocyanidophosphate

Phosphoramidocyanidic acid, N-ethyl-N-1-methylethyl-, propyl ester

O-Propyl N-ethyl-N-isopropylphosphoramidocyanidate

O-n-Propyl N-ethyl-N-isopropylphosphoramidocyanidate

n-Propyl N-ethyl-N-isopropylphosphoramidocyanidate

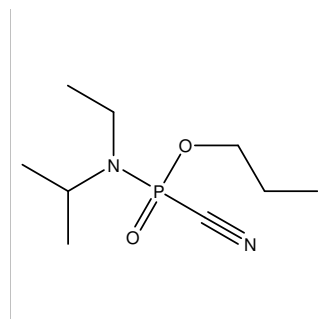

**Chemical name:** Propyl N-ethyl-N-propylphosphoramidocyanidate

Schedule: 1A02

CAS RN: 1256571-94-4

HS code: 2931.39

Key: 1256571-94-4

Molecular formula: C<sub>9</sub>H<sub>19</sub>N<sub>2</sub>O<sub>2</sub>P

CAS Index Name: Phosphoramidocyanidic acid, ethylpropyl-, propyl ester

**IUPAC name:** Propyl ethylpropylphosphoramidocyanidoate

Synonyms: Propyl ethyl(propyl)amidocyanidophosphate

Phosphoramidocyanidic acid, N-ethyl-N-propyl-, propyl ester

O-Propyl N-ethyl-N-propylphosphoramidocyanidate

O-n-Propyl N-ethyl-N-propylphosphoramidocyanidate

n-Propyl N-ethyl-N-propylphosphoramidocyanidate

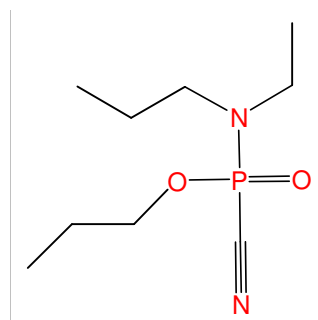

**Chemical name:** Propyl N-methyl-N-propylphosphoramidocyanidate

Schedule: 1A02

CAS RN: 1256571-95-5

HS code: 2931.39

Key: 1256571-95-5

Molecular formula: C<sub>8</sub>H<sub>17</sub>N<sub>2</sub>O<sub>2</sub>P

CAS Index Name: Phosphoramidocyanidic acid, methylpropyl-, propyl ester

**IUPAC name:** Propyl methylpropylphosphoramidocyanidoate

Synonyms: Propyl methyl(propyl)amidocyanidophosphate

Phosphoramidocyanidic acid, N-methyl-N-propyl-, propyl ester

O-Propyl N-methyl-N-propylphosphoramidocyanidate

O-n-Propyl N-methyl-N-propylphosphoramidocyanidate

n-Propyl N-methyl-N-propylphosphoramidocyanidate

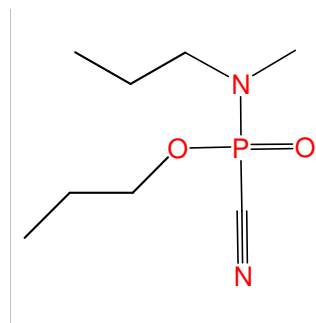

**Chemical name:** Butyl N-ethyl-N-isopropylphosphoramidocyanidate

Schedule: 1A02

CAS RN: 1256571-96-6

HS code: 2931.39

Key: 1256571-96-6

Molecular formula: C<sub>10</sub>H<sub>21</sub>N<sub>2</sub>O<sub>2</sub>P

CAS Index Name: Phosphoramidocyanidic acid, ethyl(1-methylethyl)-, butyl ester

**IUPAC name:** Butyl ethylisopropylphosphoramidocyanidoate

Synonyms: Phosphoramidocyanidic acid, N-ethyl-N-1-methylethyl-, butyl ester

O-Butyl N-ethyl-N-isopropylphosphoramidocyanidate

n-Butyl N-ethyl-N-isopropylphosphoramidocyanidate

Butyl ethyl(isopropyl)amidocyanidophosphate

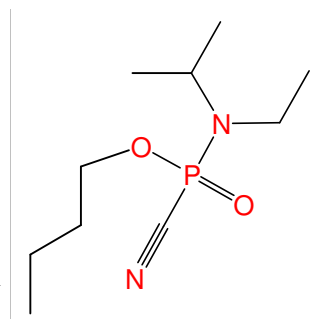

**Chemical name:** Butyl N-ethyl-N-propylphosphoramidocyanidate

Schedule: 1A02

CAS RN: 1256571-97-7

HS code: 2931.39

Key: 1256571-97-7

Molecular formula: C<sub>10</sub>H<sub>21</sub>N<sub>2</sub>O<sub>2</sub>P

CAS Index Name: Phosphoramidocyanidic acid, ethylpropyl-, butyl ester

**IUPAC name:** Butyl ethylpropylphosphoramidocyanidoate

Synonyms: Phosphoramidocyanidic acid, N-ethyl-N-propyl-, butyl ester

O-Butyl N-ethyl-N-propylphosphoramidocyanidate

n-Butyl N-ethyl-N-propylphosphoramidocyanidate

Butyl ethyl(propyl)amidocyanidophosphate

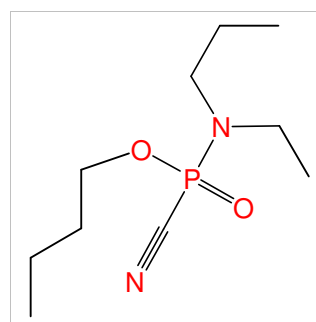

**Chemical name:** 1,3-Dimethylbutyl N,N-diisopropylphosphoramidocyanidate

Schedule: 1A02

CAS RN: 1256572-10-7

HS code: 2931.39

Key: 1256572-10-7

Molecular formula: C<sub>13</sub>H<sub>27</sub>N<sub>2</sub>O<sub>2</sub>P

CAS Index Name: Phosphoramidocyanidic acid, bis(1-methylethyl)-, 1,3-dimethylbutyl ester

**IUPAC name:** 1,3-Dimethylbutyl diisopropylphosphoramidocyanidoate

Synonyms: Phosphoramidocyanidic acid, bis(N-1-methylethyl)-, 1,3-dimethylbutyl ester

O-1,3-Dimethylbutyl N,N-diisopropylphosphoramidocyanidate

4-Methylpentan-2-yl N,N-diisopropylphosphoramidocyanidate

4-Methylpent-2-yl N,N-diisopropylphosphoramidocyanidate

1,3-Dimethylbutyl diisopropylamidocyanidophosphate

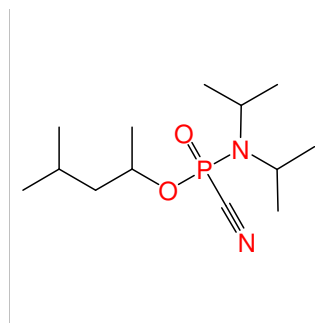

**Chemical name:** Cyclohexyl N,N-diethylphosphoramidocyanidate

Schedule: 1A02

CAS RN: 1256572-11-8

HS code: 2931.39

Key: 1256572-11-8

Molecular formula: C<sub>11</sub>H<sub>21</sub>N<sub>2</sub>O<sub>2</sub>P

CAS Index Name: Phosphoramidocyanidic acid, diethyl-, cyclohexyl ester

**IUPAC name:** Cyclohexyl diethylphosphoramidocyanidoate

Synonyms: Phosphoramidocyanidic acid, N,N-diethyl-, cyclohexyl ester

O-Cyclohexyl N,N-diethylphosphoramidocyanidate

Cyclohexyl diethylamidocyanidophosphate

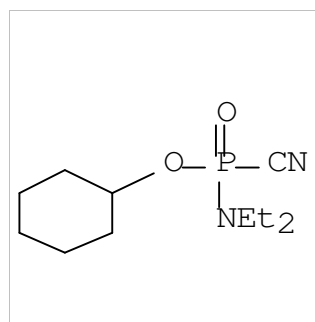

**Chemical name:** Cyclohexyl N,N-dimethylphosphoramidocyanidate

Schedule: 1A02

CAS RN: 1256572-12-9

HS code: 2931.39

Key: 1256572-12-9

Molecular formula: C<sub>9</sub>H<sub>17</sub>N<sub>2</sub>O<sub>2</sub>P

CAS Index Name: Phosphoramidocyanidic acid, dimethyl-, cyclohexyl ester

**IUPAC name:** Cyclohexyl dimethylphosphoramidocyanidoate

Synonyms: Phosphoramidocyanidic acid, N,N-dimethyl-, cyclohexyl ester

O-Cyclohexyl N,N-dimethylphosphoramidocyanidate

Cyclohexyl dimethylamidocyanidophosphate

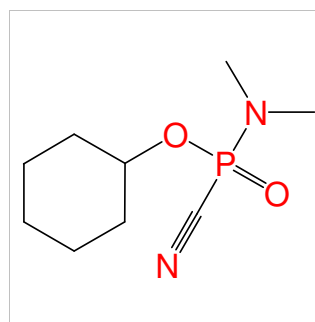

**Chemical name:** Cyclohexyl N,N-dipropylphosphoramidocyanidate

Schedule: 1A02

CAS RN: 1256572-13-0

HS code: 2931.39

Key: 1256572-13-0

Molecular formula: C<sub>13</sub>H<sub>25</sub>N<sub>2</sub>O<sub>2</sub>P

CAS Index Name: Phosphoramidocyanidic acid, dipropyl-, cyclohexyl ester

**IUPAC name:** Cyclohexyl dipropylphosphoramidocyanidoate

Synonyms: Phosphoramidocyanidic acid, N,N-dipropyl-, cyclohexyl ester

O-Cyclohexyl N,N-dipropylphosphoramidocyanidate

Cyclohexyl dipropylamidocyanidophosphate

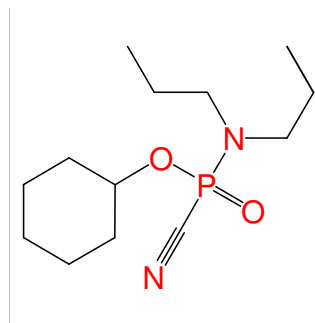

**Chemical name:** Octyl N,N-diethylphosphoramidocyanidate

Schedule: 1A02

CAS RN: 1256572-14-1

HS code: 2931.39

Key: 1256572-14-1

Molecular formula: C<sub>13</sub>H<sub>27</sub>N<sub>2</sub>O<sub>2</sub>P

CAS Index Name: Phosphoramidocyanidic acid, diethyl-, octyl ester

**IUPAC name:** Octyl diethylphosphoramidocyanidoate

Synonyms: Phosphoramidocyanidic acid, N,N-diethyl-, octyl ester

Octyl diethylamidocyanidophosphate

O-Octyl N,N-diethylphosphoramidocyanidate

n-Octyl N,N-diethylphosphoramidocyanidate

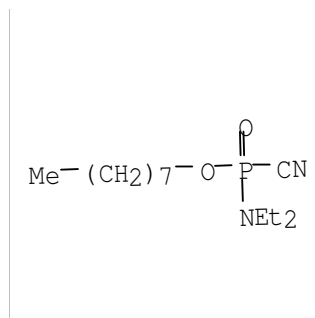

**Chemical name:** Octyl N,N-diisopropylphosphoramidocyanidate

Schedule: 1A02

CAS RN: 1256572-15-2

HS code: 2931.39

Key: 1256572-15-2

Molecular formula: C<sub>15</sub>H<sub>31</sub>N<sub>2</sub>O<sub>2</sub>P

CAS Index Name: Phosphoramidocyanidic acid, bis(1-methylethyl)-, octyl ester

**IUPAC name:** Octyl diisopropylphosphoramidocyanidoate

Synonyms: Phosphoramidocyanidic acid, bis(N-1-methylethyl)-, octyl ester

Octyl diisopropylamidocyanidophosphate

O-Octyl N,N-diisopropylphosphoramidocyanidate

n-Octyl N,N-diisopropylphosphoramidocyanidate

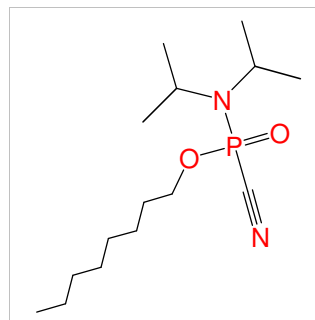

**Chemical name:** Octyl N-isopropyl-N-propylphosphoramidocyanidate

Schedule: 1A02

CAS RN: 1256572-16-3

HS code: 2931.39

Key: 1256572-16-3

Molecular formula: C<sub>15</sub>H<sub>31</sub>N<sub>2</sub>O<sub>2</sub>P

CAS Index Name: Phosphoramidocyanidic acid, (1-methylethyl)propyl-, octyl ester

**IUPAC name:** Octyl isopropylpropylphosphoramidocyanidoate

Synonyms: Phosphoramidocyanidic acid, N-1-methylethyl-N-propyl-, octyl ester

Octyl N-isopropyl-N-propylamidocyanidophosphate

Octyl isopropyl(propyl)amidocyanidophosphate

O-Octyl N-isopropyl-N-propylphosphoramidocyanidate

n-Octyl N-isopropyl-N-propylphosphoramidocyanidate

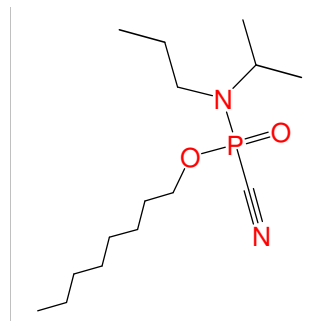

**Chemical name:** Octyl N,N-dipropylphosphoramidocyanidate

Schedule: 1A02

CAS RN: 1256572-17-4

HS code: 2931.39

Key: 1256572-17-4

Molecular formula: C<sub>15</sub>H<sub>31</sub>N<sub>2</sub>O<sub>2</sub>P

CAS Index Name: Phosphoramidocyanidic acid, dipropyl-, octyl ester

**IUPAC name:** Octyl dipropylphosphoramidocyanidoate

Synonyms: Phosphoramidocyanidic acid, N,N-dipropyl-, octyl ester

Octyl dipropylamidocyanidophosphate

O-Octyl N,N-dipropylphosphoramidocyanidate

n-Octyl N,N-dipropylphosphoramidocyanidate

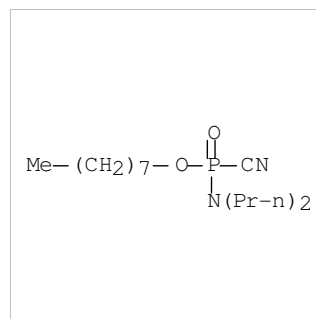

**Chemical name:** Decyl N,N-diisopropylphosphoramidocyanidate

Schedule: 1A02

CAS RN: 1256572-18-5

HS code: 2931.39

Key: 1256572-18-5

Molecular formula: C<sub>17</sub>H<sub>35</sub>N<sub>2</sub>O<sub>2</sub>P

CAS Index Name: Phosphoramidocyanidic acid, bis(1-methylethyl)-, decyl ester

**IUPAC name:** Decyl diisopropylphosphoramidocyanidoate

Synonyms: Phosphoramidocyanidic acid, bis(N-1-methylethyl)-, decyl ester

O-Decyl N,N-diisopropylphosphoramidocyanidate

n-Decyl N,N-diisopropylphosphoramidocyanidate

Decyl diisopropylamidocyanidophosphate

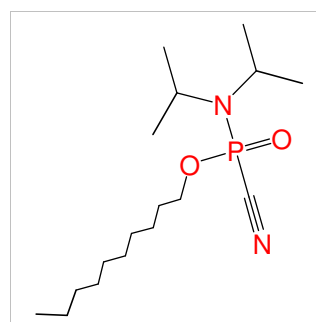

**Chemical name:** Decyl N-isopropyl-N-propylphosphoramidocyanidate

Schedule: 1A02

CAS RN: 1256572-19-6

HS code: 2931.39

Key: 1256572-19-6

Molecular formula: C<sub>17</sub>H<sub>35</sub>N<sub>2</sub>O<sub>2</sub>P

CAS Index Name: Phosphoramidocyanidic acid, (1-methylethyl)propyl-, decyl ester

**IUPAC name:** Decyl isopropylpropylphosphoramidocyanidoate

Synonyms: Phosphoramidocyanidic acid, N-1-methylethyl-N-propyl-, decyl ester

O-Decyl N-isopropyl-N-propylphosphoramidocyanidate

n-Decyl N-isopropyl-N-propylphosphoramidocyanidate

Decyl isopropyl(propyl)amidocyanidophosphate

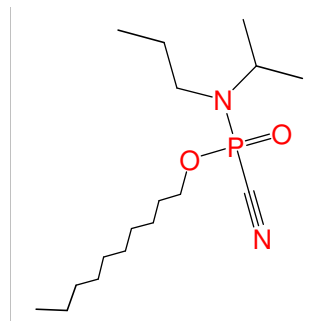

**Chemical name:** 1-Cyclohexylethyl N,N-diisopropylphosphoramidocyanidate

Schedule: 1A02

CAS RN: 1256572-20-9

HS code: 2931.39

Key: 1256572-20-9

Molecular formula: C<sub>15</sub>H<sub>29</sub>N<sub>2</sub>O<sub>2</sub>P

CAS Index Name: Phosphoramidocyanidic acid, bis(1-methylethyl)-, 1-cyclohexylethyl ester

**IUPAC name:** 1-Cyclohexylethyl diisopropylphosphoramidocyanidoate

Synonyms: O-1-Cyclohexylethyl N,N- diisopropylphosphoramidocyanidate

1-Cyclohexylethyl diisopropylamidocyanidophosphate

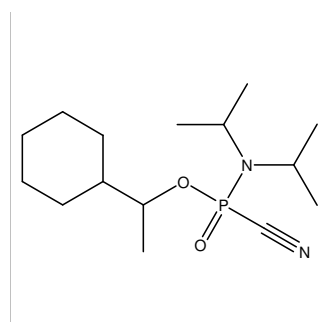

**Chemical name:** 1-Ethylhexyl N,N-diethylphosphoramidocyanidate

Schedule: 1A02

CAS RN: 1256572-21-0

HS code: 2931.39

Key: 1256572-21-0

Molecular formula: C<sub>13</sub>H<sub>27</sub>N<sub>2</sub>O<sub>2</sub>P

CAS Index Name: Phosphoramidocyanidic acid, diethyl-, 1-ethylhexyl ester

**IUPAC name:** 1-Ethylhexyl diethylphosphoramidocyanidoate

Synonyms: Phosphoramidocyanidic acid, N,N-diethyl-, 1-ethylhexyl ester

Octan-3-yl N,N-diethylphosphoramidocyanidate

Oct-3-yl N,N-diethylphosphoramidocyanidate

O-1-Ethylhexyl N,N-diethylphosphoramidocyanidate

1-Ethylhexyl diethylamidocyanidophosphate

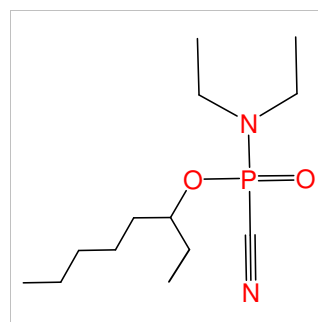



**Chemical name:** 1-Ethylhexyl N,N-diisopropylphosphoramidocyanidate

Schedule: 1A02

CAS RN: 1256572-22-1

HS code: 2931.39

Key: 1256572-22-1

Molecular formula: C<sub>15</sub>H<sub>31</sub>N<sub>2</sub>O<sub>2</sub>P

CAS Index Name: Phosphoramidocyanidic acid, bis(1-methylethyl)-, 1-ethylhexyl ester

**IUPAC name:** 1-Ethylhexyl diisopropylphosphoramidocyanidoate

Synonyms: Phosphoramidocyanidic acid, bis(N-1-methylethyl)-, 1-ethylhexyl ester

Octan-3-yl N,N-diisopropylphosphoramidocyanidate

Oct-3-yl N,N-diisopropylphosphoramidocyanidate

O-1-Ethylhexyl N,N-diisopropylphosphoramidocyanidate

1-Ethylhexyl diisopropylamidocyanidophosphate

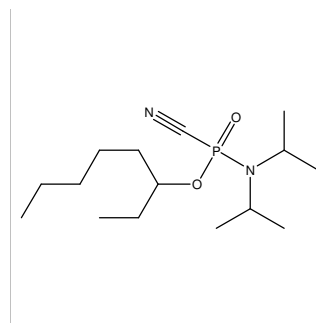

**Chemical name:** 1-Ethylhexyl N-isopropyl-N-propylphosphoramidocyanidate

Schedule: 1A02

CAS RN: 1256572-23-2

HS code: 2931.39

Key: 1256572-23-2

Molecular formula: C<sub>15</sub>H<sub>31</sub>N<sub>2</sub>O<sub>2</sub>P

CAS Index Name: Phosphoramidocyanidic acid, (1-methylethyl)propyl-, 1-ethylhexyl ester

**IUPAC name:** 1-Ethylhexyl isopropylpropylphosphoramidocyanidoate

Synonyms: Phosphoramidocyanidic acid, N-1-methylethyl-N-propyl-, 1-ethylhexyl ester

Octan-3-yl N-isopropyl-N-propylphosphoramidocyanidate

Oct-3-yl N-isopropyl-N-propylphosphoramidocyanidate

O-1-Ethylhexyl N-isopropyl-N-propylphosphoramidocyanidate

1-Ethylhexyl isopropyl(propyl)amidocyanidophosphate

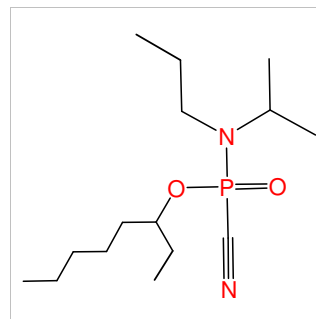

**Chemical name:** 1-Ethylhexyl N,N-dipropylphosphoramidocyanidate

Schedule: 1A02

CAS RN: 1256572-24-3

HS code: 2931.39

Key: 1256572-24-3

Molecular formula: C<sub>15</sub>H<sub>31</sub>N<sub>2</sub>O<sub>2</sub>P

CAS Index Name: Phosphoramidocyanidic acid, dipropyl-, 1-ethylhexyl ester

**IUPAC name:** 1-Ethylhexyl dipropylphosphoramidocyanidoate

Synonyms: Phosphoramidocyanidic acid, N,N-dipropyl-, 1-ethylhexyl ester

Octan-3-yl N,N-dipropylphosphoramidocyanidate

Oct-3-yl N,N-dipropylphosphoramidocyanidate

O-1-Ethylhexyl N,N-dipropylphosphoramidocyanidate

1-Ethylhexyl dipropylamidocyanidophosphate

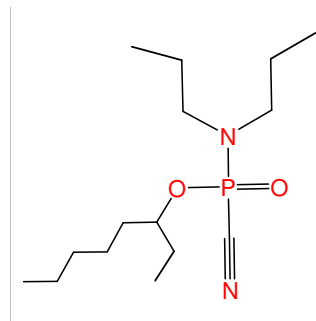

**Chemical name:** 1,1,2-Trimethylpropyl N,N-diethylphosphoramidocyanidate

Schedule: 1A02

CAS RN: 1256572-25-4

HS code: 2931.39

Key: 1256572-25-4

Molecular formula: C<sub>11</sub>H<sub>23</sub>N<sub>2</sub>O<sub>2</sub>P

CAS Index Name: Phosphoramidocyanidic acid, N,N-diethyl-, 1,1,2-trimethylpropyl ester

**IUPAC name:**

Synonyms:

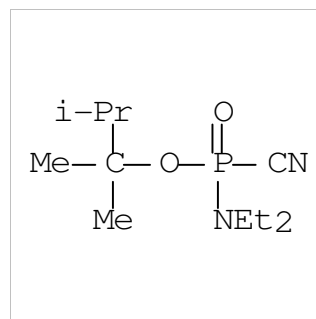

**Chemical name:** 1,1,2-Trimethylpropyl N,N-diisopropylphosphoramidocyanidate

Schedule: 1A02

CAS RN: 1256634-75-9

HS code: 2931.39

Key: 1256634-75-9

Molecular formula: C<sub>13</sub>H<sub>27</sub>N<sub>2</sub>O<sub>2</sub>P

CAS Index Name: Phosphoramidocyanidic acid, N,N-bis(1-methylethyl)-, 1,1,2-trimethylpropyl ester

**IUPAC name:**

Synonyms:

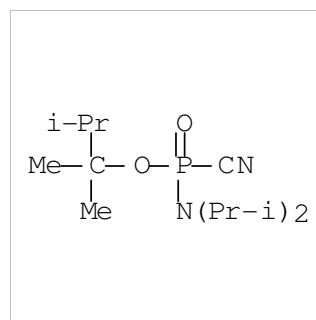

**Chemical name:** 1,1,2-Trimethylpropyl N-propyl-N-isopropylphosphoramidocyanidate

Schedule: 1A02

CAS RN: 1256634-76-0

HS code: 2931.39

Key: 1256634-76-0

Molecular formula: C<sub>13</sub>H<sub>27</sub>N<sub>2</sub>O<sub>2</sub>P

CAS Index Name: Phosphoramidocyanidic acid, N-(1-methylethyl)-N-propyl-, 1,1,2-trimethylpropyl ester

**IUPAC name:**

Synonyms:

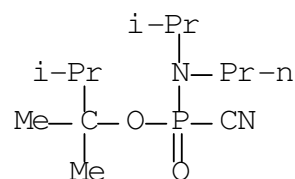

**Chemical name:** 1,1,2-Trimethylpropyl N,N-dimethylphosphoramidocyanidate

Schedule: 1A02

CAS RN: 1256634-77-1

HS code: 2931.39

Key: 1256634-77-1

Molecular formula: C<sub>9</sub>H<sub>19</sub>N<sub>2</sub>O<sub>2</sub>P

CAS Index Name: Phosphoramidocyanidic acid, N,N-dimethyl-, 1,1,2-trimethylpropyl ester

**IUPAC name:**

Synonyms:

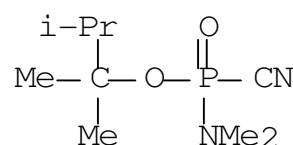

**Chemical name:** Cycloheptyl N,N-diethylphosphoramidocyanidate

Schedule: 1A02

CAS RN: 1256634-78-2

HS code: 2931.39

Key: 1256634-78-2

Molecular formula: C<sub>12</sub>H<sub>23</sub>N<sub>2</sub>O<sub>2</sub>P

CAS Index Name: Phosphoramidocyanidic acid, diethyl-, cycloheptyl ester

**IUPAC name:** Cycloheptyl diethylphosphoramidocyanidoate

Synonyms: Phosphoramidocyanidic acid, N,N-diethyl-, cycloheptyl ester

O-Cycloheptyl N,N-diethylphosphoramidocyanidate

Cycloheptyl diethylamidocyanidophosphate

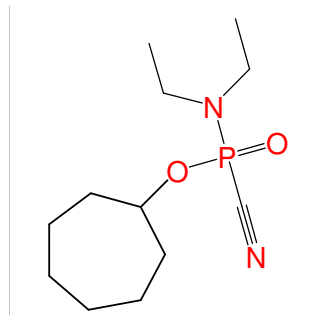

**Chemical name:** Cycloheptyl N,N-dimethylphosphoramidocyanidate

Schedule: 1A02

CAS RN: 1256634-79-3

HS code: 2931.39

Key: 1256634-79-3

Molecular formula: C<sub>10</sub>H<sub>19</sub>N<sub>2</sub>O<sub>2</sub>P

CAS Index Name: Phosphoramidocyanidic acid, dimethyl-, cycloheptyl ester

**IUPAC name:** Cycloheptyl dimethylphosphoramidocyanidoate

Synonyms: Phosphoramidocyanidic acid, N,N-dimethyl-, cycloheptyl ester

O-Cycloheptyl N,N-dimethylphosphoramidocyanidate

Cycloheptyl dimethylamidocyanidophosphate

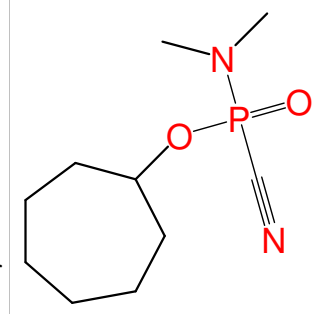

**Chemical name:** 2,6-Dimethylcyclohexyl N,N-diethylphosphoramidocyanidate

Schedule: 1A02

CAS RN: 1256634-80-6

HS code: 2931.39

Key: 1256634-80-6

Molecular formula: C<sub>13</sub>H<sub>25</sub>N<sub>2</sub>O<sub>2</sub>P

CAS Index Name: Phosphoramidocyanidic acid, diethyl-, 2,6-dimethylcyclohexyl ester

**IUPAC name:** 2,6-Dimethylcyclohexyl diethylphosphoramidocyanidoate

Synonyms: Phosphoramidocyanidic acid, N,N-diethyl-, 2,6-dimethylcyclohexyl ester

O-2,6-Dimethylcyclohexyl N,N-diethylphosphoramidocyanidate

2,6-Dimethylcyclohexyl diethylamidocyanidophosphate

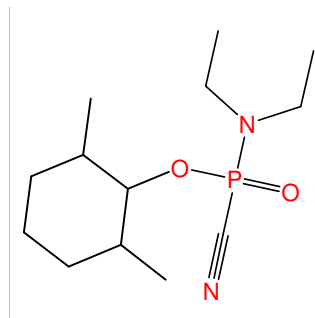

**Chemical name:** 2,6-Dimethylcyclohexyl N,N-diisopropylphosphoramidocyanidate

Schedule: 1A02

CAS RN: 1256634-81-7

HS code: 2931.39

Key: 1256634-81-7

Molecular formula: C<sub>15</sub>H<sub>29</sub>N<sub>2</sub>O<sub>2</sub>P

CAS Index Name: Phosphoramidocyanidic acid, bis(1-methylethyl)-, 2,6-dimethylcyclohexyl ester

**IUPAC name:** 2,6-Dimethylcyclohexyl diisopropylphosphoramidocyanidoate

Synonyms: Phosphoramidocyanidic acid, bis(N-1-methylethyl)-, 2,6-dimethylcyclohexyl ester

O-2,6-Dimethylcyclohexyl N,N-diisopropylphosphoramidocyanidate

2,6-Dimethylcyclohexyl diisopropylamidocyanidophosphate

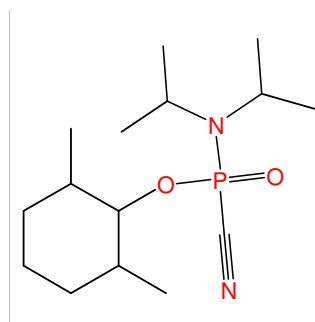

**Chemical name:** 2,6-Dimethylcyclohexyl N-isopropyl-N-propylphosphoramidocyanidate

Schedule: 1A02

CAS RN: 1256634-82-8

HS code: 2931.39

Key: 1256634-82-8

Molecular formula: C<sub>15</sub>H<sub>29</sub>N<sub>2</sub>O<sub>2</sub>P

CAS Index Name: Phosphoramidocyanidic acid, (1-methylethyl)propyl-, 2,6-dimethylcyclohexyl ester

**IUPAC name:** 2,6-Dimethylcyclohexyl isopropylpropylphosphoramidocyanidoate

Synonyms: Phosphoramidocyanidic acid, N-1-methylethyl-N-propyl-, 2,6-dimethylcyclohexyl ester;  
O-2,6-Dimethylcyclohexyl N-isopropyl-N-propylphosphoramidocyanidate  
2,6-Dimethylcyclohexyl isopropyl(propyl)amidocyanidophosphate

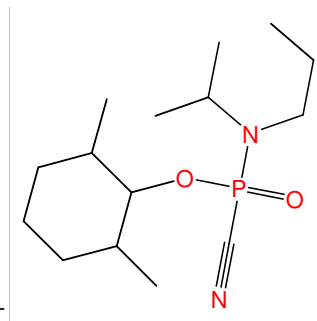

**Chemical name:** 2,6-Dimethylcyclohexyl N,N-dimethylphosphoramidocyanidate

Schedule: 1A02

CAS RN: 1256634-83-9

HS code: 2931.39

Key: 1256634-83-9

Molecular formula: C<sub>11</sub>H<sub>21</sub>N<sub>2</sub>O<sub>2</sub>P

CAS Index Name: Phosphoramidocyanidic acid, dimethyl-, 2,6-dimethylcyclohexyl ester

**IUPAC name:** 2,6-Dimethylcyclohexyl dimethylphosphoramidocyanidoate

Synonyms: Phosphoramidocyanidic acid, N,N-dimethyl-, 2,6-dimethylcyclohexyl ester  
O-2,6-Dimethylcyclohexyl N,N-dimethylphosphoramidocyanidate  
2,6-Dimethylcyclohexyl dimethylamidocyanidophosphate

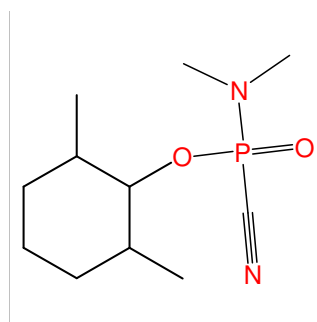

**Chemical name:** 1-Ethylpentyl N,N-diisopropylphosphoramidocyanidate

Schedule: 1A02

CAS RN: 1256634-84-0

HS code: 2931.39

Key: 1256634-84-0

Molecular formula: C<sub>14</sub>H<sub>29</sub>N<sub>2</sub>O<sub>2</sub>P

CAS Index Name: Phosphoramidocyanidic acid, bis(1-methylethyl)-, 1-ethylpentyl ester

**IUPAC name:** 1-Ethylpentyl diisopropylphosphoramidocyanidoate

Synonyms: Phosphoramidocyanidic acid, bis(N-1-methylethyl)-, 1-ethylpentyl ester  
O-1-Ethylpentyl N,N-diisopropylphosphoramidocyanidate  
Heptan-3-yl N,N-diisopropylphosphoramidocyanidate  
Hept-3-yl N,N-diisopropylphosphoramidocyanidate  
1-Ethylpentyl diisopropylamidocyanidophosphate

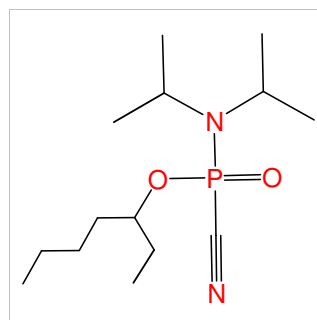

**Chemical name:** 2-Methylcyclohexyl N,N-diisopropylphosphoramidocyanidate

Schedule: 1A02

CAS RN: 1256634-85-1

HS code: 2931.39

Key: 1256634-85-1

Molecular formula: C<sub>14</sub>H<sub>27</sub>N<sub>2</sub>O<sub>2</sub>P

CAS Index Name: Phosphoramidocyanidic acid, N,N-bis(1-methylethyl)-, 2-methylcyclohexyl ester

**IUPAC name:**

Synonyms:

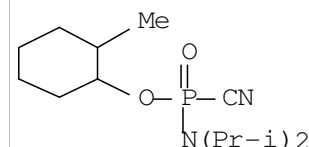

**Chemical name:** 1,2-Dimethylpropyl N,N-diisopropylphosphoramidocyanidate

Schedule: 1A02

CAS RN: 1256634-86-2

HS code: 2931.39

Key: 1256634-86-2

Molecular formula: C<sub>12</sub>H<sub>25</sub>N<sub>2</sub>O<sub>2</sub>P

CAS Index Name: Phosphoramidocyanidic acid, bis(1-methylethyl)-, 1,2-dimethylpropyl ester

**IUPAC name:** 1,2-Dimethylpropyl diisopropylphosphoramidocyanidoate

Synonyms: Phosphoramidocyanidic acid, bis(N-1-methylethyl)-, 1,2-dimethylpropyl ester

O-1,2-Dimethylpropyl N,N-diisopropylphosphoramidocyanidate

3-Methylbutan-2-yl N,N-diisopropylphosphoramidocyanidate

3-Methylbut-2-yl N,N-diisopropylphosphoramidocyanidate

1,2-Dimethylpropyl diisopropylamidocyanidophosphate

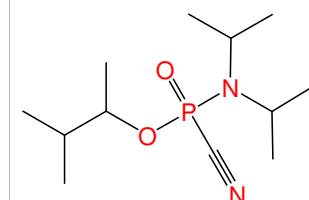

**Chemical name:** 1-Isopropyl-2-methylpropyl N,N-diethylphosphoramidocyanidate

Schedule: 1A02

CAS RN: 1256634-87-3

HS code: 2931.39

Key: 1256634-87-3

Molecular formula: C<sub>12</sub>H<sub>25</sub>N<sub>2</sub>O<sub>2</sub>P

CAS Index Name: Phosphoramidocyanidic acid, diethyl-, 1-(1-methylethyl)-2-methylpropyl ester

**IUPAC name:** 1-Isopropyl-2-methylpropyl diethylphosphoramidocyanidoate

Synonyms: Phosphoramidocyanidic acid, N,N-diethyl-, 2,4-dimethylpent-3-yl ester

O-1-Isopropyl-2-methylpropyl N,N-diethylphosphoramidocyanidate

2,4-Dimethylpentan-3-yl N,N-diethylphosphoramidocyanidate

2,4-Dimethylpent-3-yl N,N-diethylphosphoramidocyanidate

1-Isopropylisobutyl N,N-diethylphosphoramidocyanidate

1-Isopropyl-2-methylpropyl diethylamidocyanidophosphate

1-(1-methylethyl)-2-methylpropyl N,N-diethylphosphoramidocyanidate

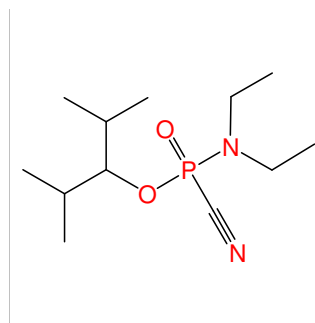

**Chemical name:** 1-Isopropyl-2-methylpropyl N,N-diisopropylphosphoramidocyanidate

Schedule: 1A02

CAS RN: 1256634-88-4

HS code: 2931.39

Key: 1256634-88-4

Molecular formula: C<sub>14</sub>H<sub>29</sub>N<sub>2</sub>O<sub>2</sub>P

CAS Index Name: Phosphoramidocyanidic acid, bis(1-methylethyl)-, 1-(1-methylethyl)-2-methylpropyl ester

**IUPAC name:** 1-Isopropyl-2-methylpropyl diisopropylphosphoramidocyanidoate

Synonyms: Phosphoramidocyanidic acid, bis(N-1-methylethyl)-, 2,4-dimethylpent-3-yl ester

O-1-Isopropyl-2-methylpropyl N,N-diisopropylphosphoramidocyanidate

2,4-Dimethylpentan-3-yl N,N-diisopropylphosphoramidocyanidate

2,4-Dimethylpent-3-yl N,N-diisopropylphosphoramidocyanidate

1-Isopropylisobutyl N,N-diisopropylphosphoramidocyanidate

1-Isopropyl-2-methylpropyl diisopropylamidocyanidophosphate

1-(1-methylethyl)-2-methylpropyl N,N-diisopropylphosphoramidocyanidate

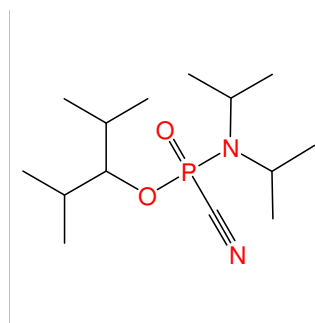

**Chemical name:** 1-Isopropyl-2-methylpropyl N,N-dimethylphosphoramidocyanidate

Schedule: 1A02

CAS RN: 1256634-89-5

HS code: 2931.39

Key: 1256634-89-5

Molecular formula: C<sub>10</sub>H<sub>21</sub>N<sub>2</sub>O<sub>2</sub>P

CAS Index Name: Phosphoramidocyanidic acid, dimethyl-, 1-(1-methylethyl)-2-methylpropyl ester

**IUPAC name:** 1-Isopropyl-2-methylpropyl dimethylphosphoramidocyanidoate

Synonyms: Phosphoramidocyanidic acid, N,N-dimethyl-, 2,4-dimethylpent-3-yl ester

O-1-Isopropyl-2-methylpropyl N,N-dimethylphosphoramidocyanidate

2,4-Dimethylpentan-3-yl N,N-dimethylphosphoramidocyanidate

2,4-Dimethylpent-3-yl N,N-dimethylphosphoramidocyanidate

1-Isopropylisobutyl N,N-dimethylphosphoramidocyanidate

1-Isopropyl-2-methylpropyl dimethylamidocyanidophosphate

1-(1-Methylethyl)-2-methylpropyl N,N-dimethylphosphoramidocyanidate

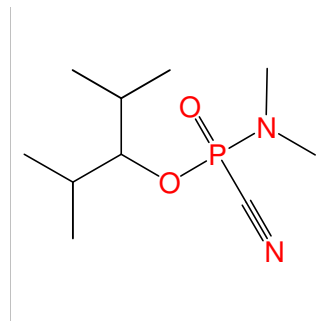

**Chemical name:** 1-Isopropyl-2-methylpropyl N,N-dipropylphosphoramidocyanidate

Schedule: 1A02

CAS RN: 1256634-90-8

HS code: 2931.39

Key: 1256634-90-8

Molecular formula: C<sub>14</sub>H<sub>29</sub>N<sub>2</sub>O<sub>2</sub>P

CAS Index Name: Phosphoramidocyanidic acid, dipropyl-, 1-(1-methylethyl)-2-methylpropyl ester

**IUPAC name:**

Synonyms: Phosphoramidocyanidic acid, N,N-dipropyl-, 2,4-dimethylpent-3-yl ester

O-1-Isopropyl-2-methylpropyl N,N-dipropylphosphoramidocyanidate

2,4-Dimethylpentan-3-yl N,N-dipropylphosphoramidocyanidate

2,4-Dimethylpent-3-yl N,N-dipropylphosphoramidocyanidate

1-Isopropylisobutyl N,N-dipropylphosphoramidocyanidate

1-Isopropyl-2-methylpropyl dipropylamidocyanidophosphate

1-(1-Methylethyl)-2-methylpropyl N,N-dipropylphosphoramidocyanidate

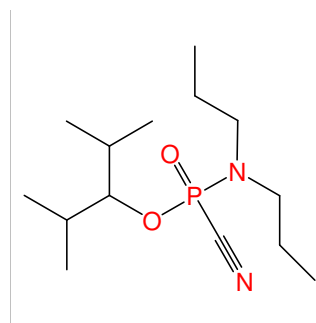



**Chemical name:** 1-Ethylbutyl N,N-diisopropylphosphoramidocyanidate

Schedule: 1A02

CAS RN: 1256634-91-9

HS code: 2931.39

Key: 1256634-91-9

Molecular formula: C<sub>13</sub>H<sub>27</sub>N<sub>2</sub>O<sub>2</sub>P

CAS Index Name: Phosphoramidocyanidic acid, bis(1-methylethyl)-, 1-ethylbutyl ester

**IUPAC name:** 1-Ethylbutyl diisopropylphosphoramidocyanidoate

Synonyms: Phosphoramidocyanidic acid, bis(N-1-methylethyl)-, 1-ethylbutyl ester

O-1-Ethylbutyl N,N-diisopropylphosphoramidocyanidate

Hexan-3-yl N,N-diisopropylphosphoramidocyanidate

Hex-3-yl N,N-diisopropylphosphoramidocyanidate

1-Ethylbutyl diisopropylamidocyanidophosphate

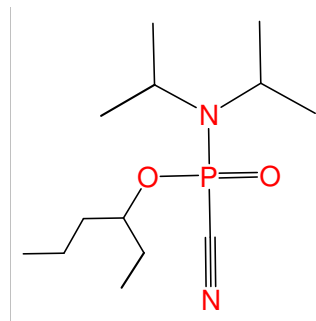

**Chemical name:** Isopropyl N-isopropyl-N-propylphosphoramidocyanidate

Schedule: 1A02

CAS RN: 1256634-92-0

HS code: 2931.39

Key: 1256634-92-0

Molecular formula: C<sub>10</sub>H<sub>21</sub>N<sub>2</sub>O<sub>2</sub>P

CAS Index Name: Phosphoramidocyanidic acid, (1-methylethyl)propyl-, 1-methylethyl ester

**IUPAC name:** Isopropyl isopropylpropylphosphoramidocyanidoate

Synonyms: Phosphoramidocyanidic acid, N-1-methylethyl-N-propyl-, 1-methylethyl ester

O-Isopropyl N-isopropyl-N-propylphosphoramidocyanidate

Isopropyl isopropyl(propyl)amidocyanidophosphate

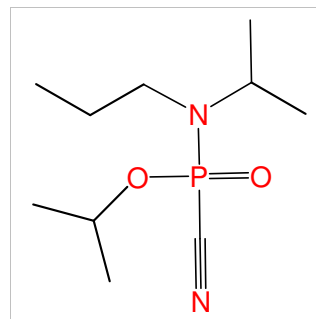

**Chemical name:** Isopropyl N,N-dipropylphosphoramidocyanidate

Schedule: 1A02

CAS RN: 1256634-93-1

HS code: 2931.39

Key: 1256634-93-1

Molecular formula: C<sub>10</sub>H<sub>21</sub>N<sub>2</sub>O<sub>2</sub>P

CAS Index Name: Phosphoramidocyanidic acid, dipropyl-, 1-methylethyl ester

**IUPAC name:** Isopropyl dipropylphosphoramidocyanidoate

Synonyms: Phosphoramidocyanidic acid, N,N-dipropyl-, 1-methylethyl ester

O-Isopropyl N,N-dipropylphosphoramidocyanidate

Isopropyl dipropylamidocyanidophosphate

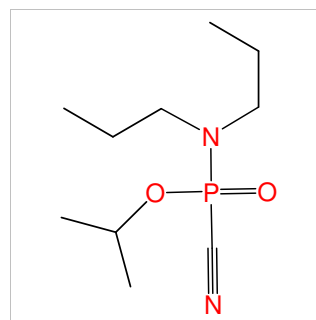

**Chemical name:** Cyclooctyl N,N-dimethylphosphoramidocyanidate

Schedule: 1A02

CAS RN: 1256634-94-2

HS code: 2931.39

Key: 1256634-94-2

Molecular formula: C<sub>11</sub>H<sub>21</sub>N<sub>2</sub>O<sub>2</sub>P

CAS Index Name: Phosphoramidocyanidic acid, dimethyl-, cyclooctyl ester

**IUPAC name:** Cyclooctyl dimethylphosphoramidocyanidoate

Synonyms: Phosphoramidocyanidic acid, N,N-dimethyl-, cyclooctyl ester

O-Cyclooctyl N,N-dimethylphosphoramidocyanidate

Cyclooctyl dimethylamidocyanidophosphate

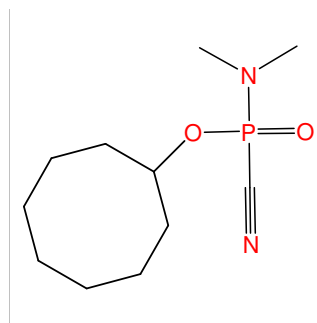

**Chemical name:** Isobutyl N-isopropyl-N-methylphosphoramidocyanidate

Schedule: 1A02

CAS RN: 1281955-87-0

HS code: 2931.39

Key: 1281955-87-0

Molecular formula: C<sub>9</sub>H<sub>19</sub>N<sub>2</sub>O<sub>2</sub>P

CAS Index Name: Phosphoramidocyanidic acid, (1-methylethyl)methyl-, 2-methylpropyl ester

**IUPAC name:** Isobutyl isopropylmethylphosphoramidocyanidoate

Synonyms: Phosphoramidocyanidic acid, N-methyl-N-1-methylethyl-, 2-methylpropyl ester

O-Isobutyl N-isopropyl-N-methylphosphoramidocyanidate

O-2-Methylpropyl N-isopropyl-N-methylphosphoramidocyanidate

Isobutyl isopropyl(methyl)amidocyanidophosphate

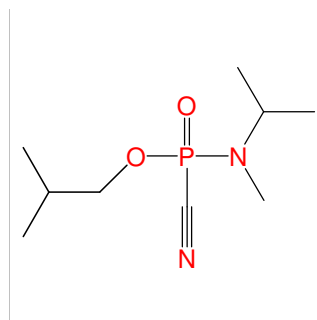

**Chemical name:** Isobutyl N-isopropyl-N-propylphosphoramidocyanidate

Schedule: 1A02

CAS RN: 1281955-88-1

HS code: 2931.39

Key: 1281955-88-1

Molecular formula: C<sub>11</sub>H<sub>23</sub>N<sub>2</sub>O<sub>2</sub>P

CAS Index Name: Phosphoramidocyanidic acid, (1-methylethyl)propyl-, 2-methylpropyl ester

**IUPAC name:** Isobutyl isopropylpropylphosphoramidocyanidoate

Synonyms: Phosphoramidocyanidic acid, N-1-methylethyl-N-propyl-, 2-methylpropyl ester

O-Isobutyl N-isopropyl-N-propylphosphoramidocyanidate

O-2-Methylpropyl N-isopropyl-N-propylphosphoramidocyanidate

Isobutyl isopropyl(propyl)amidocyanidophosphate

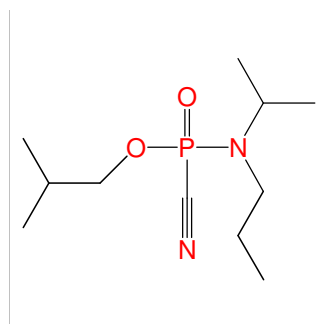

**Chemical name:** Isobutyl N,N-dipropylphosphoramidocyanidate

Schedule: 1A02

CAS RN: 1281955-89-2

HS code: 2931.39

Key: 1281955-89-2

Molecular formula: C<sub>11</sub>H<sub>23</sub>N<sub>2</sub>O<sub>2</sub>P

CAS Index Name: Phosphoramidocyanidic acid, dipropyl-, 2-methylpropyl ester

**IUPAC name:** Isobutyl dipropylphosphoramidocyanidoate

Synonyms: Phosphoramidocyanidic acid, N,N-dipropyl-, 2-methylpropyl ester

O-Isobutyl N,N-dipropylphosphoramidocyanidate

O-2-Methylpropyl N,N-dipropylphosphoramidocyanidate

Isobutyl dipropylamidocyanidophosphate

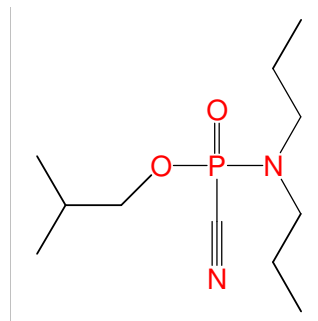

**Chemical name:** sec-Butyl N,N-diethylphosphoramidocyanidate

Schedule: 1A02

CAS RN: 1281955-92-7

HS code: 2931.39

Key: 1281955-92-7

Molecular formula: C<sub>9</sub>H<sub>19</sub>N<sub>2</sub>O<sub>2</sub>P

CAS Index Name: Phosphoramidocyanidic acid, diethyl-, 1-methylpropyl ester

**IUPAC name:** sec-Butyl diethylphosphoramidocyanidoate

Synonyms: sec-Butyl diethylamidocyanidophosphate

Phosphoramidocyanidic acid, N,N-diethyl-, 1-methylpropyl ester

O-sec-Butyl N,N-diethylphosphoramidocyanidate

Butan-2-yl N,N-diethylphosphoramidocyanidate

But-2-yl N,N-diethylphosphoramidocyanidate

1-Methylpropyl N,N-diethylphosphoramidocyanidate

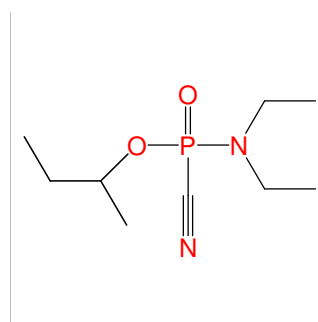

**Chemical name:** sec-Butyl N-ethyl-N-isopropylphosphoramidocyanidate

Schedule: 1A02

CAS RN: 1281955-93-8

HS code: 2931.39

Key: 1281955-93-8

Molecular formula: C<sub>10</sub>H<sub>21</sub>N<sub>2</sub>O<sub>2</sub>P

CAS Index Name: Phosphoramidocyanidic acid, ethyl(1-methylethyl)-, 1-methylpropyl ester

**IUPAC name:** sec-Butyl ethylisopropylphosphoramidocyanidoate

**Synonyms:** sec-Butyl ethyl(isopropyl)amidocyanidophosphate

Phosphoramidocyanidic acid, N-ethyl-N-1-methylethyl-, 1-methylpropyl ester

O-sec-Butyl N-ethyl-N-isopropylphosphoramidocyanidate

Butan-2-yl N-ethyl-N-isopropylphosphoramidocyanidate

But-2-yl N-ethyl-N-isopropylphosphoramidocyanidate

1-Methylpropyl N-ethyl-N-isopropylphosphoramidocyanidate

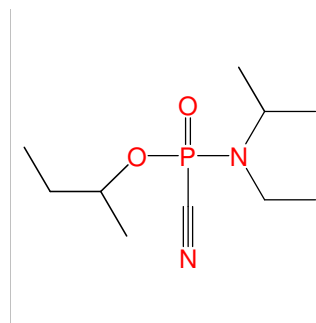

**Chemical name:** sec-Butyl N-ethyl-N-methylphosphoramidocyanidate

Schedule: 1A02

CAS RN: 1281955-94-9

HS code: 2931.39

Key: 1281955-94-9

Molecular formula: C<sub>8</sub>H<sub>17</sub>N<sub>2</sub>O<sub>2</sub>P

CAS Index Name: Phosphoramidocyanidic acid, N-ethyl-N-methyl-, 1-methylpropyl ester

**IUPAC name:** sec-Butyl ethylmethylphosphoramidocyanidoate

**Synonyms:** sec-Butyl ethyl(methyl)amidocyanidophosphate

Phosphoramidocyanidic acid, N-ethyl-N-methyl-, 1-methylpropyl ester

O-sec-Butyl N-ethyl-N-methylphosphoramidocyanidate

Butan-2-yl N-ethyl-N-methylphosphoramidocyanidate

But-2-yl N-ethyl-N-methylphosphoramidocyanidate

1-Methylpropyl N-ethyl-N-methylphosphoramidocyanidate

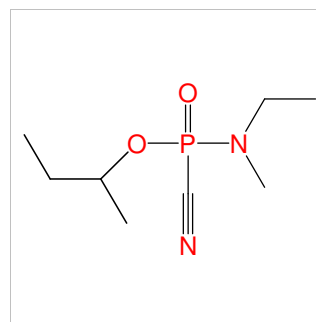

**Chemical name:** sec-Butyl N,N-diisopropylphosphoramidocyanidate

Schedule: 1A02

CAS RN: 1281955-95-0

HS code: 2931.39

Key: 1281955-95-0

Molecular formula: C<sub>11</sub>H<sub>23</sub>N<sub>2</sub>O<sub>2</sub>P

CAS Index Name: Phosphoramidocyanidic acid, bis(1-methylethyl)-, 1-methylpropyl ester

**IUPAC name:** sec-Butyl diisopropylphosphoramidocyanidoate

Synonyms: sec-Butyl diisopropylamidocyanidophosphate

Phosphoramidocyanidic acid, bis(N-1-methylethyl)-, 1-methylpropyl ester

O-sec-Butyl N,N-diisopropylphosphoramidocyanidate

Butan-2-yl N,N-diisopropylphosphoramidocyanidate

But-2-yl N,N-diisopropylphosphoramidocyanidate

1-Methylpropyl N,N-diisopropylphosphoramidocyanidate

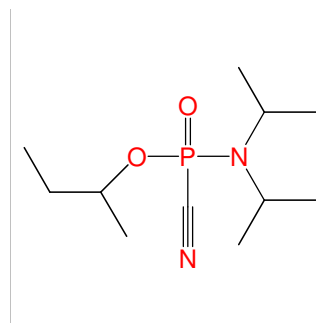

**Chemical name:** sec-Butyl N-isopropyl-N-methylphosphoramidocyanidate

Schedule: 1A02

CAS RN: 1281955-96-1

HS code: 2931.39

Key: 1281955-96-1

Molecular formula: C<sub>9</sub>H<sub>19</sub>N<sub>2</sub>O<sub>2</sub>P

CAS Index Name: Phosphoramidocyanidic acid, N-(1-methylethyl)-N-methyl-, 1-methylpropyl ester

**IUPAC name:** sec-Butyl isopropylmethylphosphoramidocyanidoate

Synonyms: sec-Butyl isopropyl(methyl)amidocyanidophosphate

Phosphoramidocyanidic acid, N-methyl-N-1-methylethyl-, 1-methylpropyl ester

O-sec-Butyl N-isopropyl-N-methylphosphoramidocyanidate

Butan-2-yl N-isopropyl-N-methylphosphoramidocyanidate

But-2-yl N-isopropyl-N-methylphosphoramidocyanidate

1-Methylpropyl N-isopropyl-N-methylphosphoramidocyanidate

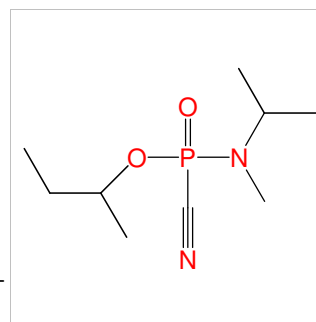

**Chemical name:** sec-Butyl N-isopropyl-N-propylphosphoramidocyanidate

Schedule: 1A02

CAS RN: 1281955-97-2

HS code: 2931.39

Key: 1281955-97-2

Molecular formula: C<sub>11</sub>H<sub>23</sub>N<sub>2</sub>O<sub>2</sub>P

CAS Index Name: Phosphoramidocyanidic acid, N-(1-methylethyl)-N-propyl-, 1-methylpropyl ester

**IUPAC name:** sec-Butyl isopropylpropylphosphoramidocyanidoate

Synonyms: sec-Butyl isopropyl(propyl)amidocyanidophosphate

Phosphoramidocyanidic acid, N-1-methylethyl-N-propyl-, 1-methylpropyl ester

O-sec-Butyl N-isopropyl-N-propylphosphoramidocyanidate

Butan-2-yl N-isopropyl-N-propylphosphoramidocyanidate

But-2-yl N-isopropyl-N-propylphosphoramidocyanidate

1-Methylpropyl N-isopropyl-N-propylphosphoramidocyanidate

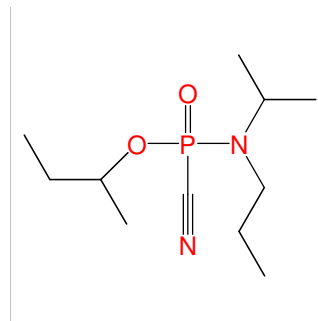

**Chemical name:** sec-Butyl N,N-dipropylphosphoramidocyanidate

Schedule: 1A02

CAS RN: 1281955-98-3

HS code: 2931.39

Key: 1281955-98-3

Molecular formula: C<sub>11</sub>H<sub>23</sub>N<sub>2</sub>O<sub>2</sub>P

CAS Index Name: Phosphoramidocyanidic acid, N,N-dipropyl-, 1-methylpropyl ester

**IUPAC name:** sec-Butyl dipropylphosphoramidocyanidoate

Synonyms: sec-Butyl dipropylamidocyanidophosphate

Phosphoramidocyanidic acid, N,N-dipropyl-, 1-methylpropyl ester

O-sec-Butyl N,N-dipropylphosphoramidocyanidate

Butan-2-yl N,N-dipropylphosphoramidocyanidate

But-2-yl N,N-dipropylphosphoramidocyanidate

1-Methylpropyl N,N-dipropylphosphoramidocyanidate

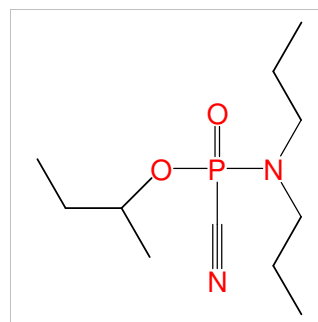

**Chemical name:** 2-Ethylhexyl N,N-dimethylphosphoramidocyanidate

Schedule: 1A02

CAS RN: 1311200-06-2

HS code: 2931.39

Key: 1311200-06-2

Molecular formula: C<sub>11</sub>H<sub>23</sub>N<sub>2</sub>O<sub>2</sub>P

CAS Index Name: Phosphoramidocyanidic acid, N,N-dimethyl-, 2-ethylhexyl ester

**IUPAC name:**

Synonyms:

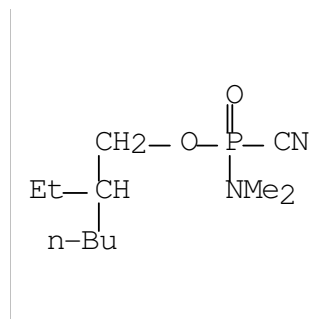

**Chemical name:** 1-Methylpentyl N,N-dimethylphosphoramidocyanidate

Schedule: 1A02

CAS RN: 1311200-07-3

HS code: 2931.39

Key: 1311200-07-3

Molecular formula: C<sub>9</sub>H<sub>19</sub>N<sub>2</sub>O<sub>2</sub>P

CAS Index Name: Phosphoramidocyanidic acid, N,N-dimethyl-, 1-methylpentyl ester

**IUPAC name:**

Synonyms:

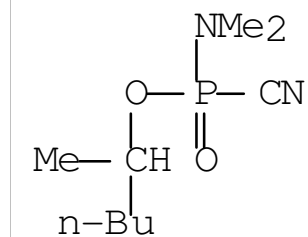

**Chemical name:** 1-Methylhexyl N,N-dimethylphosphoramidocyanidate

Schedule: 1A02

CAS RN: 1311200-08-4

HS code: 2931.39

Key: 1311200-08-4

Molecular formula: C<sub>10</sub>H<sub>21</sub>N<sub>2</sub>O<sub>2</sub>P

CAS Index Name: Phosphoramidocyanidic acid, N,N-dimethyl-, 1-methylhexyl ester

**IUPAC name:**

Synonyms:

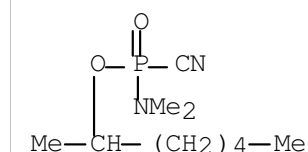

**Chemical name:** 2-Methylpentyl N-ethyl-N-methylphosphoramidocyanidate

Schedule: 1A02

CAS RN: 1311200-09-5

HS code: 2931.39

Key: 1311200-09-5

Molecular formula: C<sub>10</sub>H<sub>21</sub>N<sub>2</sub>O<sub>2</sub>P

CAS Index Name: Phosphoramidocyanidic acid, N-ethyl-N-methyl-, 2-methylpentyl ester

**IUPAC name:**

Synonyms:

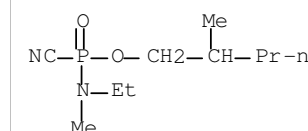

**Chemical name:** 1-Methylnonyl N-methyl-N-propylphosphoramidocyanidate

Schedule: 1A02

CAS RN: 1311200-10-8

HS code: 2931.39

Key: 1311200-10-8

Molecular formula: C<sub>15</sub>H<sub>31</sub>N<sub>2</sub>O<sub>2</sub>P

CAS Index Name: Phosphoramidocyanidic acid, N-methyl-N-propyl-, 1-methylnonyl ester

**IUPAC name:**

Synonyms:

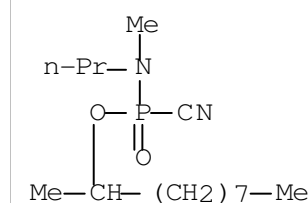

**Chemical name:** 1-Methylhexyl N-methyl-N-propylphosphoramidocyanidate

Schedule: 1A02

CAS RN: 1311200-11-9

HS code: 2931.39

Key: 1311200-11-9

Molecular formula: C<sub>12</sub>H<sub>25</sub>N<sub>2</sub>O<sub>2</sub>P

CAS Index Name: Phosphoramidocyanidic acid, N-methyl-N-propyl-, 1-methylhexyl ester

**IUPAC name:**

Synonyms:

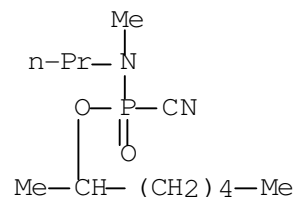

**Chemical name:** Nonyl N-isopropyl-N-methylphosphoramidocyanidate

Schedule: 1A02

CAS RN: 1311200-12-0

HS code: 2931.39

Key: 1311200-12-0

Molecular formula: C<sub>14</sub>H<sub>29</sub>N<sub>2</sub>O<sub>2</sub>P

CAS Index Name: Phosphoramidocyanidic acid, N-methyl-N-(1-methylethyl)-, nonyl ester

**IUPAC name:**

Synonyms:

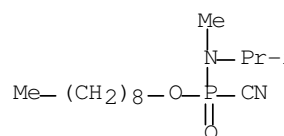

**Chemical name:** 1-Methylbutyl N,N-diisopropylphosphoramidocyanidate

Schedule: 1A02

CAS RN: 1311200-13-1

HS code: 2931.39

Key: 1311200-13-1

Molecular formula: C<sub>12</sub>H<sub>25</sub>N<sub>2</sub>O<sub>2</sub>P

CAS Index Name: Phosphoramidocyanidic acid, N,N-bis(1-methylethyl)-, 1-methylbutyl ester

**IUPAC name:**

Synonyms:

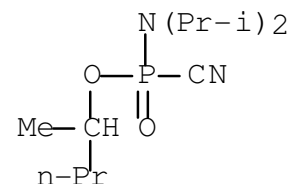



**Chemical name:** Pinacolyl N,N-dipropylphosphoramidocyanidate

Schedule: 1A02

CAS RN: 1311200-14-2

HS code: 2931.39

Key: 1311200-14-2

Molecular formula: C<sub>13</sub>H<sub>27</sub>N<sub>2</sub>O<sub>2</sub>P

CAS Index Name: Phosphoramidocyanidic acid, dipropyl-, 1,2,2-trimethylpropyl ester

**IUPAC name:** 1,2,2-Trimethylpropyl dipropylphosphoramidocyanidoate

Synonyms: Phosphoramidocyanidic acid, N,N-dipropyl-, 1,2,2-trimethylpropyl ester

O-Pinacolyl N,N-dipropylphosphoramidocyanidate

O-1,2,2-Trimethylpropyl N,N-dipropylphosphoramidocyanidate

3,3-Dimethylbutan-2-yl N,N-dipropylphosphoramidocyanidate

3,3-Dimethylbut-2-yl N,N-dipropylphosphoramidocyanidate

2,2-Dimethylbut-3-yl N,N-dipropylphosphoramidocyanidate

1,2,2-Trimethylpropyl dipropylamidocyanidophosphate

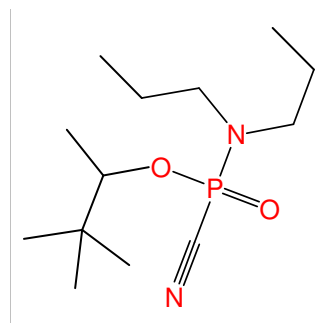

**Chemical name:** 1-Isopropyl-2-methylpentyl N-isopropyl-N-propylphosphoramidocyanidate

Schedule: 1A02

CAS RN: 1311200-15-3

HS code: 2931.39

Key: 1311200-15-3

Molecular formula: C<sub>16</sub>H<sub>33</sub>N<sub>2</sub>O<sub>2</sub>P

CAS Index Name: Phosphoramidocyanidic acid, N-(1-methylethyl)-N-propyl-, 2-methyl-1-(1-methylethyl)pentyl ester

**IUPAC name:**

Synonyms:

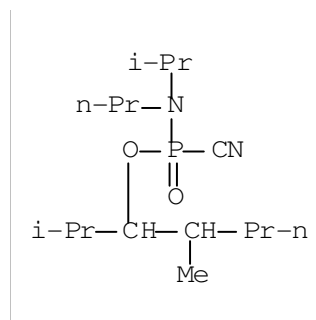

**Chemical name:** Ethyl N,N-dimethylphosphoramidocyanidate P(S)

Schedule: 1A02

CAS RN: 1428203-67-1

HS code: 2931.39

Key: 1428203-67-1

Molecular formula: C<sub>5</sub>H<sub>11</sub>N<sub>2</sub>O<sub>2</sub>P

CAS Index Name: Phosphoramidocyanidic acid, N,N-dimethyl-, ethyl ester, [P(S)]-

**IUPAC name:**

Synonyms:

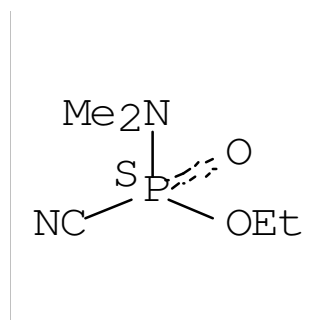

**Chemical name:** Ethyl N,N-dimethylphosphoramidocyanidate P(R)

Schedule: 1A02

CAS RN: 1428203-68-2

HS code: 2931.39

Key: 1428203-68-2

Molecular formula: C<sub>5</sub>H<sub>11</sub>N<sub>2</sub>O<sub>2</sub>P

CAS Index Name: Phosphoramidocyanidic acid, N,N-dimethyl-, ethyl ester, [P(R)]-

**IUPAC name:**

Synonyms:

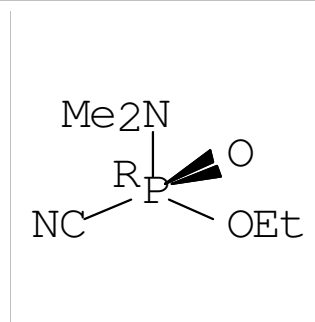

**Chemical name:** Pentyl N,N-dimethylphosphoramidocyanidate

Schedule: 1A02

CAS RN: 148461-87-4

HS code: 2931.39

Key: 148461-87-4

Molecular formula: C<sub>8</sub>H<sub>17</sub>N<sub>2</sub>O<sub>2</sub>P

CAS Index Name: Phosphoramidocyanidic acid, dimethyl-, pentyl ester

**IUPAC name:** Pentyl dimethylphosphoramidocyanidoate

Synonyms: Pentyl dimethylamidocyanidophosphate

O-Pentyl N,N-dimethylphosphoramidocyanidate

O-n-Pentyl N,N-dimethylphosphoramidocyanidate

n-Pentyl N,N-dimethylphosphoramidocyanidate

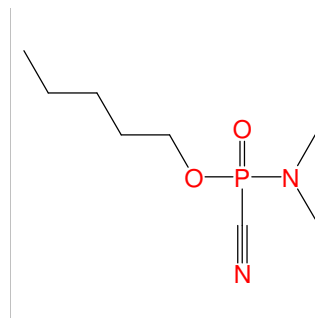

**Chemical name:** Propyl N,N-dimethylphosphoramidocyanidate

Schedule: 1A02

CAS RN: 162085-86-1

HS code: 2931.39

Key: 162085-86-1

Molecular formula: C<sub>6</sub>H<sub>13</sub>N<sub>2</sub>O<sub>2</sub>P

CAS Index Name: Phosphoramidocyanidic acid, dimethyl-, propyl ester

**IUPAC name:** Propyl dimethylphosphoramidocyanidoate

Synonyms: Propyl dimethylamidocyanidophosphate

O-Propyl N,N-dimethylphosphoramidocyanidate

O-n-Propyl N,N-dimethylphosphoramidocyanidate

n-Propyl N,N-dimethylphosphoramidocyanidate

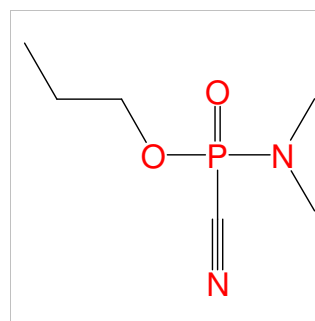

**Chemical name:** Butyl N,N-dimethylphosphoramidocyanidate

Schedule: 1A02

CAS RN: 162085-87-2

HS code: 2931.39

Key: 162085-87-2

Molecular formula: C<sub>7</sub>H<sub>15</sub>N<sub>2</sub>O<sub>2</sub>P

CAS Index Name: Phosphoramidocyanidic acid, dimethyl-, butyl ester

**IUPAC name:** Butyl dimethylphosphoramidocyanidoate

Synonyms: O-n-Butyl N,N-dimethylphosphoramidocyanidate

O-Butyl N,N-dimethylphosphoramidocyanidate

n-Butyl N,N-dimethylphosphoramidocyanidate

Butyl dimethylamidocyanidophosphate

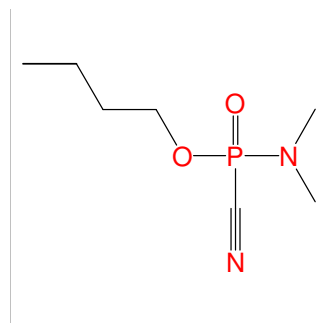

**Chemical name:** Isobutyl N,N-dimethylphosphoramidocyanidate

Schedule: 1A02

CAS RN: 162085-88-3

HS code: 2931.39

Key: 162085-88-3

Molecular formula: C<sub>7</sub>H<sub>15</sub>N<sub>2</sub>O<sub>2</sub>P

CAS Index Name: Phosphoramidocyanidic acid, dimethyl-, 2-methylpropyl ester

**IUPAC name:** Isobutyl dimethylphosphoramidocyanidoate

Synonyms: O-Isobutyl N,N-dimethylphosphoramidocyanidate

O-2-Methylpropyl N,N-dimethylphosphoramidocyanidate

Isobutyl dimethylamidocyanidophosphate

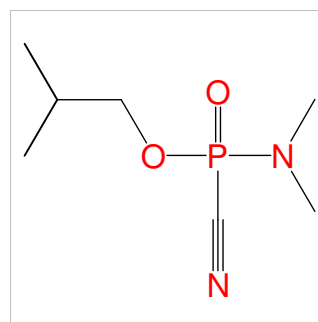

**Chemical name:** sec-Butyl N,N-dimethylphosphoramidocyanidate

Schedule: 1A02

CAS RN: 162085-89-4

HS code: 2931.39

Key: 162085-89-4

Molecular formula: C<sub>7</sub>H<sub>15</sub>N<sub>2</sub>O<sub>2</sub>P

CAS Index Name: Phosphoramidocyanidic acid, dimethyl-, 1-methylpropyl ester

**IUPAC name:** sec-Butyl dimethylphosphoramidocyanidoate

Synonyms: sec-Butyl dimethylamidocyanidophosphate

O-sec-Butyl N,N-dimethylphosphoramidocyanidate

Butan-2-yl N,N-dimethylphosphoramidocyanidate

But-2-yl N,N-dimethylphosphoramidocyanidate

1-Methylpropyl N,N-dimethylphosphoramidocyanidate

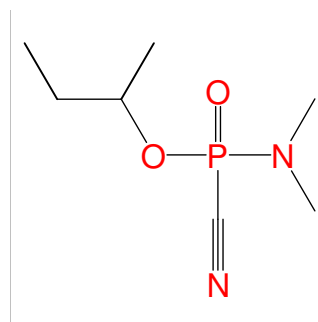

**Chemical name:** Hexyl N,N-dimethylphosphoramidocyanidate

Schedule: 1A02

CAS RN: 162085-90-7

HS code: 2931.39

Key: 162085-90-7

Molecular formula: C<sub>9</sub>H<sub>19</sub>N<sub>2</sub>O<sub>2</sub>P

CAS Index Name: Phosphoramidocyanidic acid, dimethyl-, hexyl ester

**IUPAC name:** Hexyl dimethylphosphoramidocyanidoate

Synonyms: O-n-Hexyl N,N-dimethylphosphoramidocyanidate

O-Hexyl N,N-dimethylphosphoramidocyanidate

n-Hexyl N,N-dimethylphosphoramidocyanidate

Hexyl dimethylamidocyanidophosphate

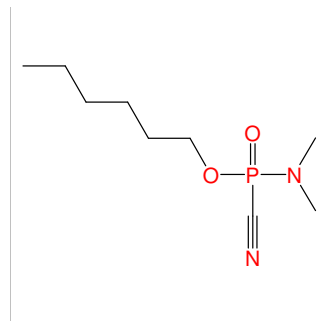

**Chemical name:** Heptyl N,N-dimethylphosphoramidocyanidate

Schedule: 1A02

CAS RN: 162085-91-8

HS code: 2931.39

Key: 162085-91-8

Molecular formula: C<sub>10</sub>H<sub>21</sub>N<sub>2</sub>O<sub>2</sub>P

CAS Index Name: Phosphoramidocyanidic acid, dimethyl-, heptyl ester

**IUPAC name:** Heptyl dimethylphosphoramidocyanidoate

Synonyms: O-n-Heptyl N,N-dimethylphosphoramidocyanidate

O-Heptyl N,N-dimethylphosphoramidocyanidate

n-Heptyl N,N-dimethylphosphoramidocyanidate

Heptyl dimethylamidocyanidophosphate

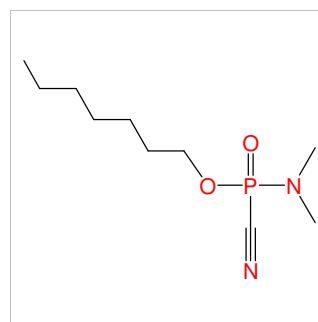

**Chemical name:** Isopropyl N,N-dimethylphosphoramidocyanidate

Schedule: 1A02

CAS RN: 63815-55-4

HS code: 2931.39

Key: 63815-55-4

Molecular formula: C<sub>6</sub>H<sub>13</sub>N<sub>2</sub>O<sub>2</sub>P

CAS Index Name: Phosphoramidocyanidic acid, dimethyl-, 1-methylethyl ester

**IUPAC name:** Isopropyl dimethylphosphoramidocyanidoate

Synonyms: O-Isopropyl N,N-dimethylphosphoramidocyanidate

Isopropyl dimethylamidocyanidophosphate

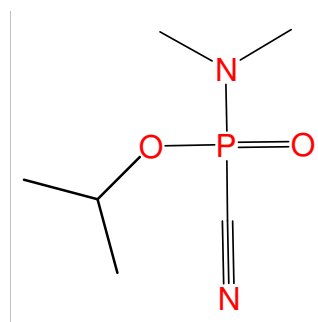

**Chemical name:** Methyl N,N-dimethylphosphoramidocyanidate

Schedule: 1A02

CAS RN: 63815-56-5

HS code: 2931.39

Key: 63815-56-5

Molecular formula: C<sub>4</sub>H<sub>9</sub>N<sub>2</sub>O<sub>2</sub>P

CAS Index Name: Phosphoramidocyanidic acid, dimethyl-, methyl ester

**IUPAC name:** Methyl dimethylphosphoramidocyanidoate

Synonyms: O-Methyl N,N-dimethylphosphoramidocyanidate

Methyl dimethylamidocyanidophosphate

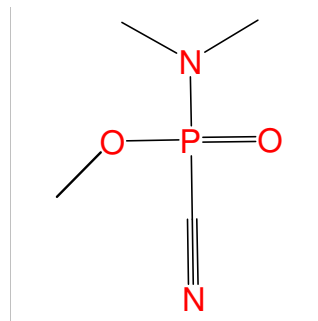

**Chemical name:** Ethyl N,N-diethylphosphoramidocyanidate

Schedule: 1A02

CAS RN: 63815-60-1

HS code: 2931.39

Key: 63815-60-1

Molecular formula: C<sub>7</sub>H<sub>15</sub>N<sub>2</sub>O<sub>2</sub>P

CAS Index Name: Phosphoramidocyanidic acid, diethyl-, ethyl ester

**IUPAC name:** Ethyl diethylphosphoramidocyanidoate

Synonyms: Phosphoramidocyanidic acid, N,N-diethyl-, ethyl ester

O-Ethyl N,N-diethylphosphoramidocyanidate

Ethyl diethylamidocyanidophosphate

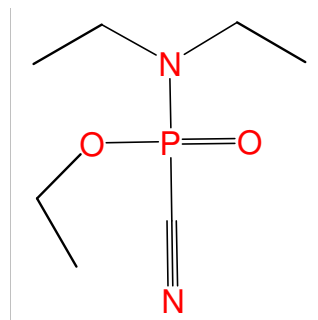

**Chemical name:** Ethyl N,N-dimethylphosphoramidocyanidate

Schedule: 1A02

CAS RN: 77-81-6

HS code: 2931.39

Key: 77-81-6

Molecular formula: C<sub>5</sub>H<sub>11</sub>N<sub>2</sub>O<sub>2</sub>P

CAS Index Name: Phosphoramidocyanidic acid, dimethyl-, ethyl ester

**IUPAC name:** Ethyl dimethylphosphoramidocyanidoate

Synonyms: Trilon 83

Tabun

O-Ethyl N,N-dimethylphosphoramidocyanidate

Gelan

GA (chemical warfare agent)

Ethyl-N-dimethylphosphoramidocyanidate

Ethyl dimethylphosphoramidocyanidate

Ethyl dimethylamidocyanophosphate

Dimethylamidoethoxyphosphorylcyanide

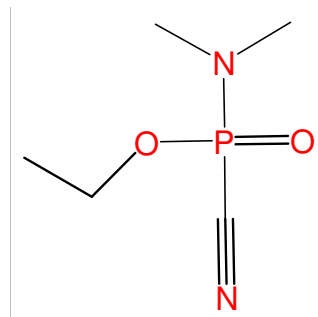

**Chemical name:** Ethyl N-ethyl-N-methylphosphoramidocyanidate

Schedule: 1A02

CAS RN: 870124-00-8

HS code: 2931.39

Key: 870124-00-8

Molecular formula: C<sub>6</sub>H<sub>13</sub>N<sub>2</sub>O<sub>2</sub>P

CAS Index Name: Phosphoramidocyanidic acid, ethylmethyl-, ethyl ester

**IUPAC name:** Ethyl ethylmethylphosphoramidocyanidoate

Synonyms: Phosphoramidocyanidic acid, N-ethyl-N-methyl-, ethyl ester

O-Ethyl N-ethyl-N-methylphosphoramidocyanidate

Ethyl ethyl(methyl)amidocyanidophosphate

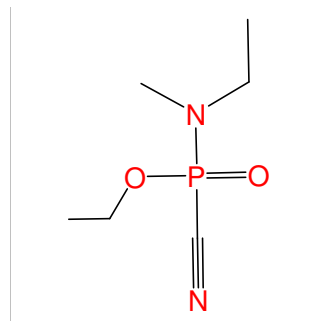

**Chemical name:** Propyl N-ethyl-N-methylphosphoramidocyanidate

Schedule: 1A02

CAS RN: 870124-01-9

HS code: 2931.39

Key: 870124-01-9

Molecular formula: C<sub>7</sub>H<sub>15</sub>N<sub>2</sub>O<sub>2</sub>P

CAS Index Name: Phosphoramidocyanidic acid, ethylmethyl-, propyl ester

**IUPAC name:** Propyl ethylmethylphosphoramidocyanidoate

Synonyms: Propyl ethyl(methyl)amidocyanidophosphate

Phosphoramidocyanidic acid, N-ethyl-N-methyl-, propyl ester

O-Propyl N-ethyl-N-methylphosphoramidocyanidate

O-n-Propyl N-ethyl-N-methylphosphoramidocyanidate

n-Propyl N-ethyl-N-methylphosphoramidocyanidate

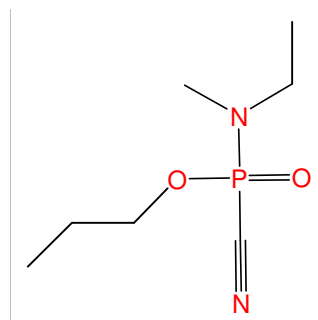

**Chemical name:** Isopropyl N-ethyl-N-methylphosphoramidocyanidate

Schedule: 1A02

CAS RN: 870124-02-0

HS code: 2931.39

Key: 870124-02-0

Molecular formula: C<sub>7</sub>H<sub>15</sub>N<sub>2</sub>O<sub>2</sub>P

CAS Index Name: Phosphoramidocyanidic acid, ethylmethyl-, 1-methylethyl ester

**IUPAC name:** Isopropyl ethylmethylphosphoramidocyanidoate

Synonyms: Phosphoramidocyanidic acid, N-ethyl-N-methyl-, 1-methylethyl ester

O-Isopropyl N-ethyl-N-methylphosphoramidocyanidate

Isopropyl ethyl(methyl)amidocyanidophosphate

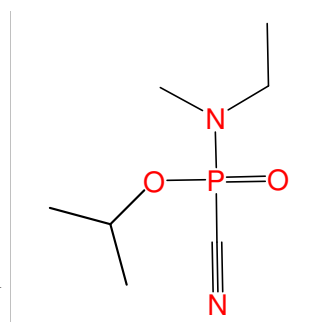

**Chemical name:** Butyl N-ethyl-N-methylphosphoramidocyanidate

Schedule: 1A02

CAS RN: 870124-03-1

HS code: 2931.39

Key: 870124-03-1

Molecular formula: C<sub>8</sub>H<sub>17</sub>N<sub>2</sub>O<sub>2</sub>P

CAS Index Name: Phosphoramidocyanidic acid, ethylmethyl-, butyl ester

**IUPAC name:** Butyl ethylmethylphosphoramidocyanidoate

Synonyms: Phosphoramidocyanidic acid, N-ethyl-N-methyl-, butyl ester

O-Butyl N-ethyl-N-methylphosphoramidocyanidate

n-Butyl N-ethyl-N-methylphosphoramidocyanidate

Butyl ethyl(methyl)amidocyanidophosphate

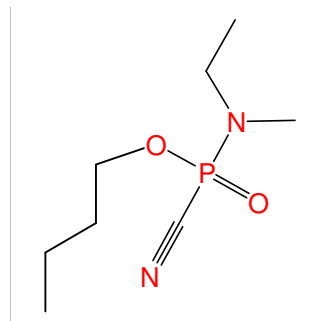

**Chemical name:** Isobutyl N-ethyl-N-methylphosphoramidocyanidate

Schedule: 1A02

CAS RN: 870124-04-2

HS code: 2931.39

Key: 870124-04-2

Molecular formula: C<sub>8</sub>H<sub>17</sub>N<sub>2</sub>O<sub>2</sub>P

CAS Index Name: Phosphoramidocyanidic acid, ethylmethyl-, 2-methylpropyl ester

**IUPAC name:** Isobutyl ethylmethylphosphoramidocyanidoate

Synonyms: Phosphoramidocyanidic acid, N-ethyl-N-methyl-, 2-methylpropyl ester

O-Isobutyl N-ethyl-N-methylphosphoramidocyanidate

O-2-Methylpropyl N-ethyl-N-methylphosphoramidocyanidate

Isobutyl ethyl(methyl)amidocyanidophosphate

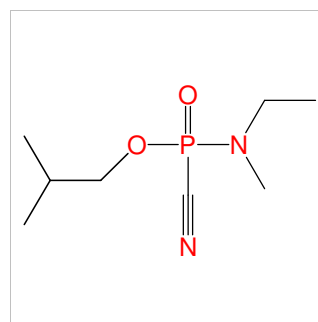

**Chemical name:** Pentyl N-ethyl-N-methylphosphoramidocyanidate

Schedule: 1A02

CAS RN: 870124-05-3

HS code: 2931.39

Key: 870124-05-3

Molecular formula: C<sub>9</sub>H<sub>19</sub>N<sub>2</sub>O<sub>2</sub>P

CAS Index Name: Phosphoramidocyanidic acid, ethylmethyl-, pentyl ester

**IUPAC name:** Pentyl ethyl(methyl)phosphoramidocyanidoate

Synonyms:

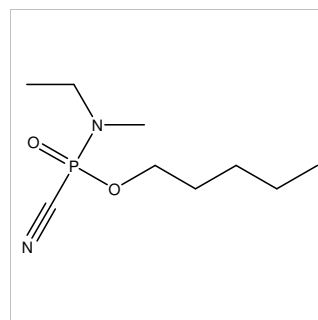

**Chemical name:** Hexyl N-ethyl-N-methylphosphoramidocyanidate

Schedule: 1A02

CAS RN: 870124-06-4

HS code: 2931.39

Key: 870124-06-4

Molecular formula: C<sub>10</sub>H<sub>21</sub>N<sub>2</sub>O<sub>2</sub>P

CAS Index Name: Phosphoramidocyanidic acid, ethylmethyl-, hexyl ester

**IUPAC name:** Hexyl ethyl(methyl)phosphoramidocyanidate

Synonyms:

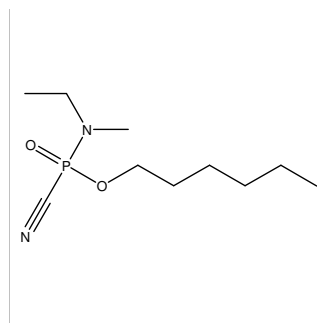

**Chemical name:** Ethyl N-methyl-N-propylphosphoramidocyanidate

Schedule: 1A02

CAS RN: 870124-07-5

HS code: 2931.39

Key: 870124-07-5

Molecular formula: C<sub>7</sub>H<sub>15</sub>N<sub>2</sub>O<sub>2</sub>P

CAS Index Name: Phosphoramidocyanidic acid, methylpropyl-, ethyl ester

**IUPAC name:** Ethyl methylpropylphosphoramidocyanidoate

Synonyms: Phosphoramidocyanidic acid, N-methyl-N-propyl-, ethyl ester

O-Ethyl N-methyl-N-propylphosphoramidocyanidate

Ethyl methyl(propyl)amidocyanidophosphate

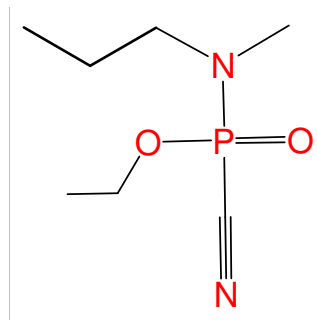

**Chemical name:** Isopropyl N-methyl-N-propylphosphoramidocyanidate

Schedule: 1A02

CAS RN: 870124-08-6

HS code: 2931.39

Key: 870124-08-6

Molecular formula: C<sub>8</sub>H<sub>17</sub>N<sub>2</sub>O<sub>2</sub>P

CAS Index Name: Phosphoramidocyanidic acid, methylpropyl-, 1-methylethyl ester

**IUPAC name:** Isopropyl methylpropylphosphoramidocyanidoate

Synonyms: Phosphoramidocyanidic acid, N-methyl-N-propyl-, 1-methylethyl ester

O-Isopropyl N-methyl-N-propylphosphoramidocyanidate

Isopropyl methyl(propyl)amidocyanidophosphate

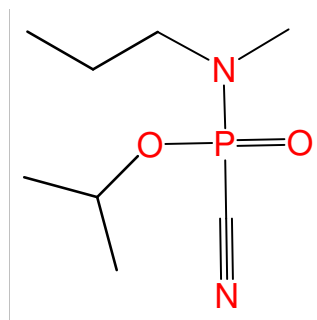



**Chemical name:** sec-Butyl N-methyl-N-propylphosphoramidocyanidate

Schedule: 1A02

CAS RN: 870124-09-7

HS code: 2931.39

Key: 870124-09-7

Molecular formula: C<sub>9</sub>H<sub>19</sub>N<sub>2</sub>O<sub>2</sub>P

CAS Index Name: Phosphoramidocyanidic acid, methylpropyl-, 1-methylpropyl ester

**IUPAC name:** sec-Butyl methylpropylphosphoramidocyanidoate

Synonyms: sec-Butyl methyl(propyl)amidocyanidophosphate

Phosphoramidocyanidic acid, N-methyl-N-propyl-, 1-methylpropyl ester

O-sec-Butyl N-methyl-N-propylphosphoramidocyanidate

Butan-2-yl N-methyl-N-propylphosphoramidocyanidate

But-2-yl N-methyl-N-propylphosphoramidocyanidate

1-Methylpropyl N-methyl-N-propylphosphoramidocyanidate

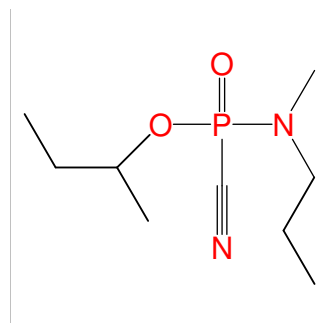

**Chemical name:** Hexyl N-methyl-N-propylphosphoramidocyanidate

Schedule: 1A02

CAS RN: 870124-10-0

HS code: 2931.39

Key: 870124-10-0

Molecular formula: C<sub>11</sub>H<sub>23</sub>N<sub>2</sub>O<sub>2</sub>P

CAS Index Name: Phosphoramidocyanidic acid, methylpropyl-, hexyl ester

**IUPAC name:** Hexyl methylpropylphosphoramidocyanidoate

Synonyms: O-Hexyl N-methyl-N-propylphosphoramidocyanidate

n-Hexyl N-methyl-N-propylphosphoramidocyanidate

Hexyl methylpropylamidocyanidophosphate

Hexyl methyl(propyl)amidocyanidophosphate

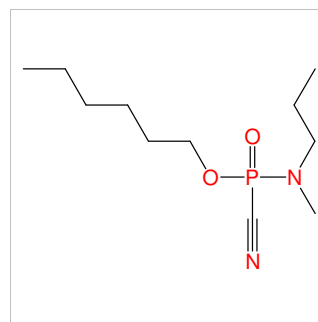

**Chemical name:** Ethyl N-isopropyl-N-methylphosphoramidocyanidate

Schedule: 1A02

CAS RN: 870124-11-1

HS code: 2931.39

Key: 870124-11-1

Molecular formula: C<sub>7</sub>H<sub>15</sub>N<sub>2</sub>O<sub>2</sub>P

CAS Index Name: Phosphoramidocyanidic acid, methyl(1-methylethyl)-, ethyl ester

**IUPAC name:** Ethyl isopropylmethylphosphoramidocyanidoate

Synonyms: Phosphoramidocyanidic acid, N-methyl-N-1-methylethyl-, ethyl ester

O-Ethyl N-isopropyl-N-methylphosphoramidocyanidate

Ethyl isopropyl(methyl)amidocyanidophosphate

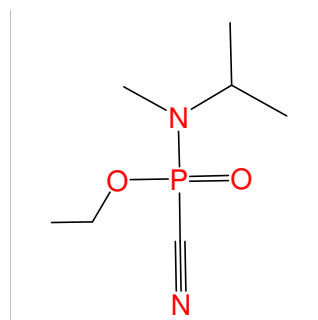

**Chemical name:** Isopropyl N-isopropyl-N-methylphosphoramidocyanidate

Schedule: 1A02

CAS RN: 870124-12-2

HS code: 2931.39

Key: 870124-12-2

Molecular formula: C<sub>8</sub>H<sub>17</sub>N<sub>2</sub>O<sub>2</sub>P

CAS Index Name: Phosphoramidocyanidic acid, (1-methylethyl)methyl-, 1-methylethyl ester

**IUPAC name:** Isopropyl isopropylmethylphosphoramidocyanidoate

Synonyms: Phosphoramidocyanidic acid, N-methyl-N-1-methylethyl-, 1-methylethyl ester

O-Isopropyl N-isopropyl-N-methylphosphoramidocyanidate

Isopropyl isopropyl(methyl)amidocyanidophosphate

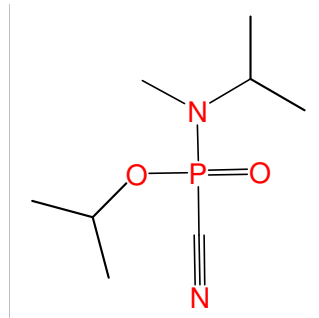

**Chemical name:** Propyl N-isopropyl-N-methylphosphoramidocyanidate

Schedule: 1A02

CAS RN: 870124-13-3

HS code: 2931.39

Key: 870124-13-3

Molecular formula: C<sub>8</sub>H<sub>17</sub>N<sub>2</sub>O<sub>2</sub>P

CAS Index Name: Phosphoramidocyanidic acid, (1-methylethyl)methyl-, propyl ester

**IUPAC name:** Propyl isopropylmethylphosphoramidocyanidoate

Synonyms: Propyl isopropyl(methyl)amidocyanidophosphate

Phosphoramidocyanidic acid, N-methyl-N-1-methylethyl-, propyl ester

O-Propyl N-isopropyl-N-methylphosphoramidocyanidate

O-n-Propyl N-isopropyl-N-methylphosphoramidocyanidate

n-Propyl N-isopropyl-N-methylphosphoramidocyanidate

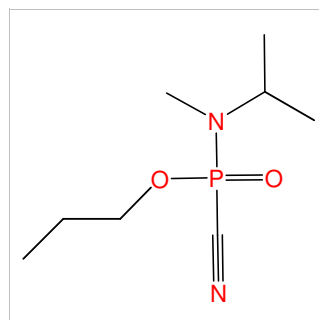

**Chemical name:** Butyl N-isopropyl-N-methylphosphoramidocyanidate

Schedule: 1A02

CAS RN: 870124-14-4

HS code: 2931.39

Key: 870124-14-4

Molecular formula: C<sub>9</sub>H<sub>19</sub>N<sub>2</sub>O<sub>2</sub>P

CAS Index Name: Phosphoramidocyanidic acid, (1-methylethyl)methyl-, butyl ester

**IUPAC name:** Butyl isopropylmethylphosphoramidocyanidoate

Synonyms: Phosphoramidocyanidic acid, N-methyl-N-1-methylethyl-, butyl ester

O-Butyl N-isopropyl-N-methylphosphoramidocyanidate

n-Butyl N-isopropyl-N-methylphosphoramidocyanidate

Butyl isopropyl(methyl)amidocyanidophosphate

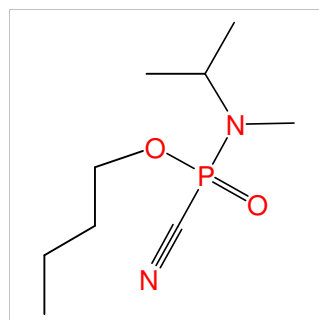

**Chemical name:** Pentyl N-isopropyl-N-methylphosphoramidocyanidate

Schedule: 1A02

CAS RN: 870124-15-5

HS code: 2931.39

Key: 870124-15-5

Molecular formula: C<sub>10</sub>H<sub>21</sub>N<sub>2</sub>O<sub>2</sub>P

CAS Index Name: Phosphoramidocyanidic acid, methyl(1-methylethyl)-, pentyl ester

**IUPAC name:** Pentyl isopropyl(methyl)phosphoramidocyanidoate

Synonyms:

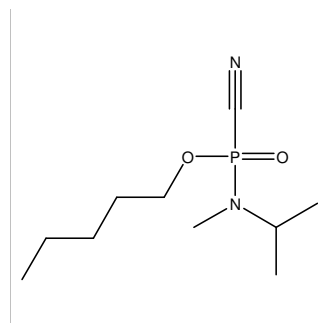

**Chemical name:** Hexyl N-isopropyl-N-methylphosphoramidocyanidate

Schedule: 1A02

CAS RN: 870124-16-6

HS code: 2931.39

Key: 870124-16-6

Molecular formula: C<sub>11</sub>H<sub>23</sub>N<sub>2</sub>O<sub>2</sub>P

CAS Index Name: Phosphoramidocyanidic acid, methyl(1-methylethyl)-, hexyl ester

**IUPAC name:**

Synonyms:

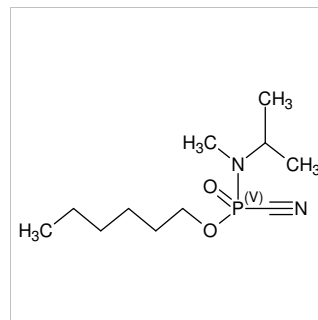

**Chemical name:** Ethyl N-ethyl-N-propylphosphoramidocyanidate

Schedule: 1A02

CAS RN: 870124-17-7

HS code: 2931.39

Key: 870124-17-7

Molecular formula: C<sub>8</sub>H<sub>17</sub>N<sub>2</sub>O<sub>2</sub>P

CAS Index Name: Phosphoramidocyanidic acid, ethylpropyl-, ethyl ester

**IUPAC name:** Ethyl ethyl(propyl)amidocyanidophosphate

Synonyms: Phosphoramidocyanidic acid, N-ethyl-N-propyl-, ethyl ester

O-Ethyl N-ethyl-N-propylphosphoramidocyanidate

Ethyl ethyl(propyl)amidocyanidophosphate

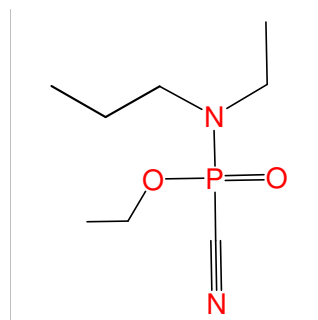

**Chemical name:** Isopropyl N-ethyl-N-propylphosphoramidocyanidate

Schedule: 1A02

CAS RN: 870124-18-8

HS code: 2931.39

Key: 870124-18-8

Molecular formula: C<sub>9</sub>H<sub>19</sub>N<sub>2</sub>O<sub>2</sub>P

CAS Index Name: Phosphoramidocyanidic acid, ethylpropyl-, 1-methylethyl ester

**IUPAC name:** Isopropyl ethylpropylphosphoramidocyanidoate

Synonyms: Phosphoramidocyanidic acid, N-ethyl-N-propyl-, 1-methylethyl ester

O-Isopropyl N-ethyl-N-propylphosphoramidocyanidate

Isopropyl ethyl(propyl)amidocyanidophosphate

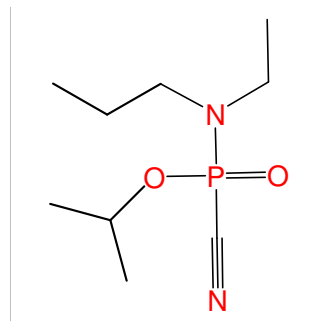

**Chemical name:** Isobutyl N-ethyl-N-propylphosphoramidocyanidate

Schedule: 1A02

CAS RN: 870124-19-9

HS code: 2931.39

Key: 870124-19-9

Molecular formula: C<sub>10</sub>H<sub>21</sub>N<sub>2</sub>O<sub>2</sub>P

CAS Index Name: Phosphoramidocyanidic acid, ethylpropyl-, 2-methylpropyl ester

**IUPAC name:** Isobutyl ethylpropylphosphoramidocyanidoate

Synonyms: Phosphoramidocyanidic acid, N-ethyl-N-propyl-, 2-methylpropyl ester

O-Isobutyl N-ethyl-N-propylphosphoramidocyanidate

O-2-Methylpropyl N-ethyl-N-propylphosphoramidocyanidate

Isobutyl ethyl(propyl)amidocyanidophosphate

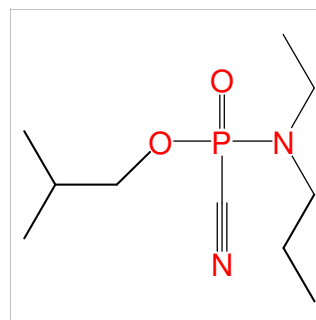

**Chemical name:** Hexyl N-ethyl-N-propylphosphoramidocyanidate

Schedule: 1A02

CAS RN: 870124-21-3

HS code: 2931.39

Key: 870124-21-3

Molecular formula: C<sub>12</sub>H<sub>25</sub>N<sub>2</sub>O<sub>2</sub>P

CAS Index Name: Phosphoramidocyanidic acid, ethylpropyl-, hexyl ester

**IUPAC name:**

Synonyms:

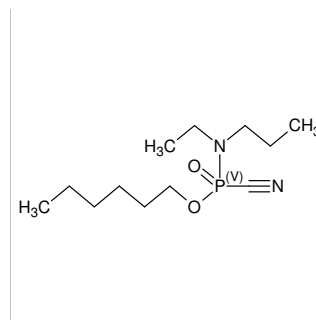

**Chemical name:** Ethyl N-ethyl-N-isopropylphosphoramidocyanidate

Schedule: 1A02

CAS RN: 870124-22-4

HS code: 2931.39

Key: 870124-22-4

Molecular formula: C<sub>8</sub>H<sub>17</sub>N<sub>2</sub>O<sub>2</sub>P

CAS Index Name: Phosphoramidocyanidic acid, ethyl(1-methylethyl)-, ethyl ester

**IUPAC name:** Ethyl ethylisopropylphosphoramidocyanidoate

Synonyms: Phosphoramidocyanidic acid, N-ethyl-N-1-methylethyl-, ethyl ester

O-Ethyl N-ethyl-N-isopropylphosphoramidocyanidate

Ethyl ethyl(isopropyl)amidocyanidophosphate

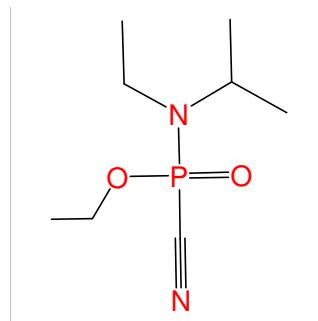

**Chemical name:** Isobutyl N-ethyl-N-isopropylphosphoramidocyanidate

Schedule: 1A02

CAS RN: 870124-23-5

HS code: 2931.39

Key: 870124-23-5

Molecular formula: C<sub>10</sub>H<sub>21</sub>N<sub>2</sub>O<sub>2</sub>P

CAS Index Name: Phosphoramidocyanidic acid, ethyl(1-methylethyl)-, 2-methylpropyl ester

**IUPAC name:** Isobutyl ethylisopropylphosphoramidocyanidoate

Synonyms: Phosphoramidocyanidic acid, N-ethyl-N-1-methylethyl-, 2-methylpropyl ester

O-Isobutyl N-ethyl-N-isopropylphosphoramidocyanidate

O-2-Methylpropyl N-ethyl-N-isopropylphosphoramidocyanidate

Isobutyl ethyl(isopropyl)amidocyanidophosphate

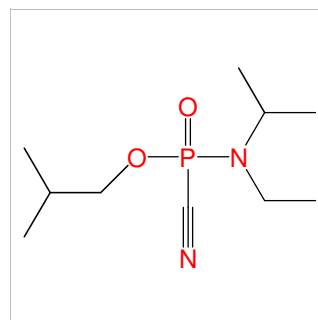

**Chemical name:** Pentyl N-ethyl-N-isopropylphosphoramidocyanidate

Schedule: 1A02

CAS RN: 870124-24-6

HS code: 2931.39

Key: 870124-24-6

Molecular formula: C<sub>11</sub>H<sub>23</sub>N<sub>2</sub>O<sub>2</sub>P

CAS Index Name: Phosphoramidocyanidic acid, ethyl(1-methylethyl)-, pentyl ester

**IUPAC name:** Pentyl ethyl(isopropyl)phosphoramidocyanidoate

Synonyms:

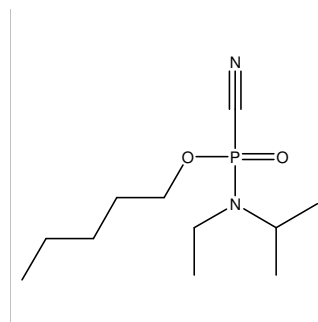

**Chemical name:** Hexyl N-ethyl-N-isopropylphosphoramidocyanidate

Schedule: 1A02

CAS RN: 870124-25-7

HS code: 2931.39

Key: 870124-25-7

Molecular formula: C<sub>12</sub>H<sub>25</sub>N<sub>2</sub>O<sub>2</sub>P

CAS Index Name: Phosphoramidocyanidic acid, ethyl(1-methylethyl)-, hexyl ester

**IUPAC name:**

Synonyms:

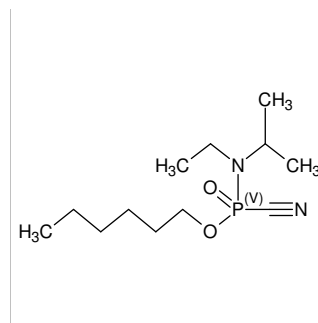

**Chemical name:** Ethyl N-isopropyl-N-propylphosphoramidocyanidate

Schedule: 1A02

CAS RN: 870124-26-8

HS code: 2931.39

Key: 870124-26-8

Molecular formula: C<sub>9</sub>H<sub>19</sub>N<sub>2</sub>O<sub>2</sub>P

CAS Index Name: Phosphoramidocyanidic acid, (1-methylethyl)propyl-, ethyl ester

**IUPAC name:** Ethyl isopropylpropylphosphoramidocyanidoate

Synonyms: Phosphoramidocyanidic acid, N-1-methylethyl-N-propyl-, ethyl ester

O-Ethyl N-isopropyl-N-propylphosphoramidocyanidate

Ethyl isopropyl(propyl)amidocyanidophosphate

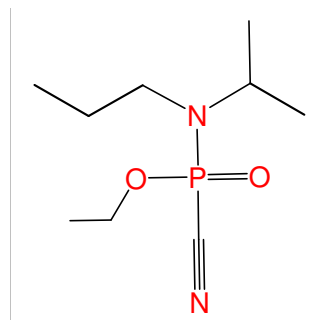

**Chemical name:** Propyl N-isopropyl-N-propylphosphoramidocyanidate

Schedule: 1A02

CAS RN: 870124-27-9

HS code: 2931.39

Key: 870124-27-9

Molecular formula: C<sub>10</sub>H<sub>21</sub>N<sub>2</sub>O<sub>2</sub>P

CAS Index Name: Phosphoramidocyanidic acid, (1-methylethyl)propyl-, propyl ester

**IUPAC name:** Propyl isopropylpropylphosphoramidocyanidoate

Synonyms: Propyl isopropyl(propyl)amidocyanidophosphate

Phosphoramidocyanidic acid, N-1-methylethyl-N-propyl-, propyl ester

O-Propyl N-isopropyl-N-propylphosphoramidocyanidate

O-n-Propyl N-isopropyl-N-propylphosphoramidocyanidate

n-Propyl N-isopropyl-N-propylphosphoramidocyanidate

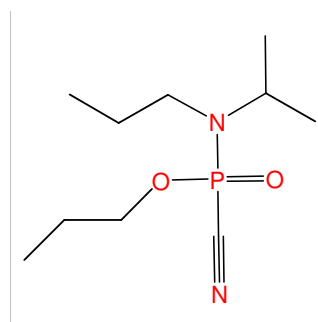

**Chemical name:** Butyl N-isopropyl-N-propylphosphoramidocyanidate

Schedule: 1A02

CAS RN: 870124-28-0

HS code: 2931.39

Key: 870124-28-0

Molecular formula: C<sub>11</sub>H<sub>23</sub>N<sub>2</sub>O<sub>2</sub>P

CAS Index Name: Phosphoramidocyanidic acid, (1-methylethyl)propyl-, butyl ester

**IUPAC name:** Butyl isopropylpropylphosphoramidocyanidoate

Synonyms: Phosphoramidocyanidic acid, N-1-methylethyl-N-propyl-, butyl ester

O-Butyl N-isopropyl-N-propylphosphoramidocyanidate

n-Butyl N-isopropyl-N-propylphosphoramidocyanidate

Butyl isopropyl(propyl)amidocyanidophosphate

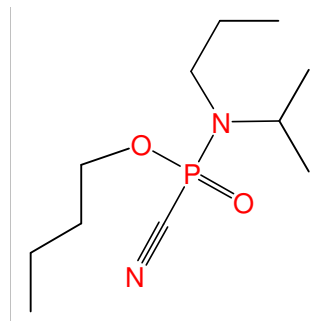

**Chemical name:** Isopropyl N,N-diethylphosphoramidocyanidate

Schedule: 1A02

CAS RN: 870124-30-4

HS code: 2931.39

Key: 870124-30-4

Molecular formula: C<sub>8</sub>H<sub>17</sub>N<sub>2</sub>O<sub>2</sub>P

CAS Index Name: Phosphoramidocyanidic acid, diethyl-, 1-methylethyl ester

**IUPAC name:** Isopropyl diethylphosphoramidocyanidoate

Synonyms: Phosphoramidocyanidic acid, N,N-diethyl-, 1-methylethyl ester

O-Isopropyl N,N-diethylphosphoramidocyanidate

Isopropyl diethylamidocyanidophosphate

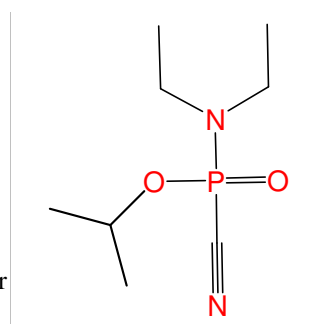

**Chemical name:** Butyl N,N-diethylphosphoramidocyanidate

Schedule: 1A02

CAS RN: 870124-31-5

HS code: 2931.39

Key: 870124-31-5

Molecular formula: C<sub>9</sub>H<sub>19</sub>N<sub>2</sub>O<sub>2</sub>P

CAS Index Name: Phosphoramidocyanidic acid, diethyl-, butyl ester

**IUPAC name:** Butyl diethylphosphoramidocyanidoate

Synonyms: Phosphoramidocyanidic acid, N,N-diethyl-, butyl ester

O-Butyl N,N-diethylphosphoramidocyanidate

n-Butyl N,N-diethylphosphoramidocyanidate

Butyl diethylamidocyanidophosphate

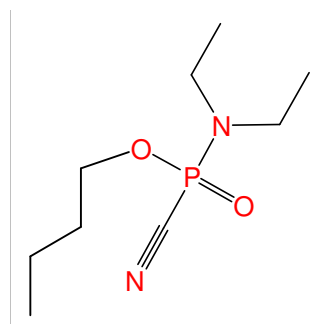

**Chemical name:** Heptyl N,N-diethylphosphoramidocyanidate

Schedule: 1A02

CAS RN: 870124-32-6

HS code: 2931.39

Key: 870124-32-6

Molecular formula: C<sub>12</sub>H<sub>25</sub>N<sub>2</sub>O<sub>2</sub>P

CAS Index Name: Phosphoramidocyanidic acid, diethyl-, heptyl ester

**IUPAC name:** Heptyl diethylphosphoramidocyanidoate

Synonyms: O-Heptyl N,N-diethylphosphoramidocyanidate

Heptyl diethylamidocyanidophosphate

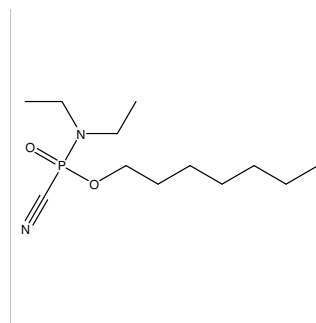

**Chemical name:** Ethyl N,N-dipropylphosphoramidocyanidate

Schedule: 1A02

CAS RN: 870124-33-7

HS code: 2931.39

Key: 870124-33-7

Molecular formula: C<sub>9</sub>H<sub>19</sub>N<sub>2</sub>O<sub>2</sub>P

CAS Index Name: Phosphoramidocyanidic acid, dipropyl-, ethyl ester

**IUPAC name:** Ethyl dipropylphosphoramidocyanidoate

Synonyms: Phosphoramidocyanidic acid, N,N-dipropyl-, ethyl ester

O-Ethyl N,N-dipropylphosphoramidocyanidate

Ethyl dipropylamidocyanidophosphate

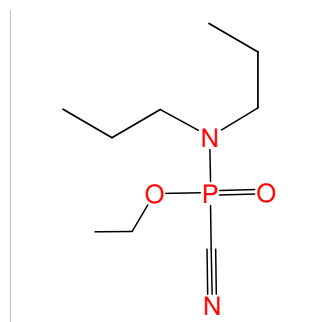

**Chemical name:** Propyl N,N-dipropylphosphoramidocyanidate

Schedule: 1A02

CAS RN: 870124-34-8

HS code: 2931.39

Key: 870124-34-8

Molecular formula: C<sub>10</sub>H<sub>21</sub>N<sub>2</sub>O<sub>2</sub>P

CAS Index Name: Phosphoramidocyanidic acid, dipropyl-, propyl ester

**IUPAC name:** Propyl dipropylphosphoramidocyanidoate

Synonyms: Propyl dipropylamidocyanidophosphate

Phosphoramidocyanidic acid, N,N-dipropyl-, propyl ester

O-Propyl N,N-dipropylphosphoramidocyanidate

O-n-Propyl N,N-dipropylphosphoramidocyanidate

n-Propyl N,N-dipropylphosphoramidocyanidate

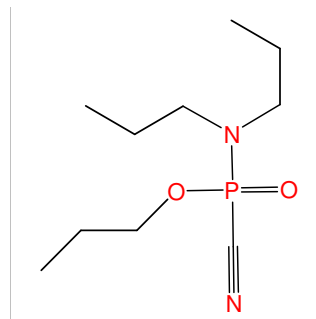



**Chemical name:** Butyl N,N-dipropylphosphoramidocyanidate

Schedule: 1A02

CAS RN: 870124-35-9

HS code: 2931.39

Key: 870124-35-9

Molecular formula: C<sub>11</sub>H<sub>23</sub>N<sub>2</sub>O<sub>2</sub>P

CAS Index Name: Phosphoramidocyanidic acid, dipropyl-, butyl ester

**IUPAC name:** Butyl dipropylphosphoramidocyanidate

Synonyms: Phosphoramidocyanidic acid, N,N-dipropyl-, butyl ester

O-Butyl N,N-dipropylphosphoramidocyanidate

n-Butyl N,N-dipropylphosphoramidocyanidate

Butyl dipropylamidocyanidophosphate

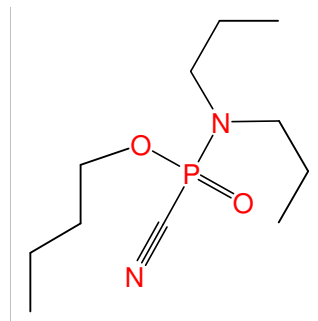

**Chemical name:** Hexyl N,N-dipropylphosphoramidocyanidate

Schedule: 1A02

CAS RN: 870124-36-0

HS code: 2931.39

Key: 870124-36-0

Molecular formula: C<sub>13</sub>H<sub>27</sub>N<sub>2</sub>O<sub>2</sub>P

CAS Index Name: Phosphoramidocyanidic acid, dipropyl-, hexyl ester

**IUPAC name:** Hexyl dipropylphosphoramidocyanidate

Synonyms:

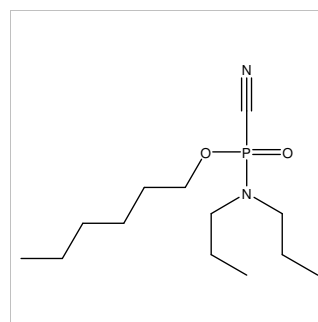

**Chemical name:** Ethyl N,N-diisopropylphosphoramidocyanidate

Schedule: 1A02

CAS RN: 870124-37-1

HS code: 2931.39

Key: 870124-37-1

Molecular formula: C<sub>9</sub>H<sub>19</sub>N<sub>2</sub>O<sub>2</sub>P

CAS Index Name: Phosphoramidocyanidic acid, bis(1-methylethyl)-, ethyl ester

**IUPAC name:** Ethyl diisopropylphosphoramidocyanidoate

Synonyms: Phosphoramidocyanidic acid, N,N-[bis(1-methylethyl)]-, ethyl ester

Phosphoramidocyanidic acid, bis-(1-methylethyl)-, ethyl ester

Phosphoramidocyanidic acid, bis(N-1-methylethyl)-, ethyl ester

O-Ethyl N,N-diisopropylphosphoramidocyanidate

Ethyl diisopropylamidocyanidophosphate

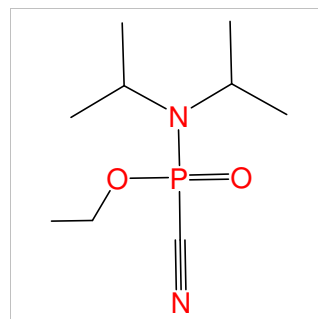

**Chemical name:** Isobutyl N,N-diisopropylphosphoramidocyanidate

Schedule: 1A02

CAS RN: 870124-38-2

HS code: 2931.39

Key: 870124-38-2

Molecular formula: C<sub>11</sub>H<sub>23</sub>N<sub>2</sub>O<sub>2</sub>P

CAS Index Name: Phosphoramidocyanidic acid, bis(1-methylethyl)-, 2-methylpropyl ester

**IUPAC name:** Isobutyl diisopropylphosphoramidocyanidoate

Synonyms: Phosphoramidocyanidic acid, bis(N-1-methylethyl)-, 2-methylpropyl ester

O-Isobutyl N,N-diisopropylphosphoramidocyanidate

O-2-Methylpropyl N,N-diisopropylphosphoramidocyanidate

Isobutyl diisopropylamidocyanidophosphate

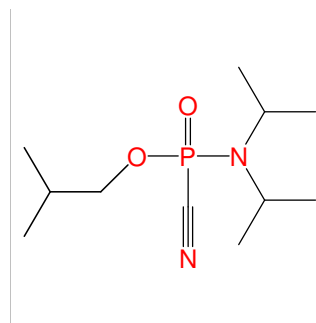

**Chemical name:** Hexyl N,N-diisopropylphosphoramidocyanidate

Schedule: 1A02

CAS RN: 870124-39-3

HS code: 2931.39

Key: 870124-39-3

Molecular formula: C<sub>13</sub>H<sub>27</sub>N<sub>2</sub>O<sub>2</sub>P

CAS Index Name: Phosphoramidocyanidic acid, bis(1-methylethyl)-, hexyl ester

**IUPAC name:** Hexyl diisopropylphosphoramidocyanidoate

Synonyms: O-Hexyl N,N-diisopropylphosphoramidocyanidate

n-Hexyl N,N-diisopropylphosphoramidocyanidate

Hexyl diisopropylamidocyanidophosphate

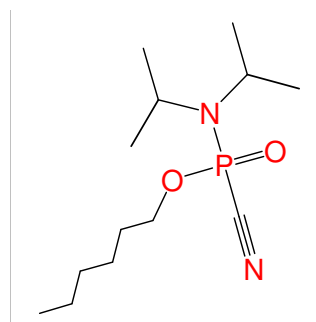

**Chemical name:** Methyl N-ethyl-N-methylphosphoramidocyanidate

Schedule: 1A02

CAS RN: 870124-40-6

HS code: 2931.39

Key: 870124-40-6

Molecular formula: C<sub>5</sub>H<sub>11</sub>N<sub>2</sub>O<sub>2</sub>P

CAS Index Name: Phosphoramidocyanidic acid, ethylmethyl-, methyl ester

**IUPAC name:** Methyl ethylmethylphosphoramidocyanidoate

Synonyms: Phosphoramidocyanidic acid, N-ethyl-N-methyl-, methyl ester

O-Methyl N-ethyl-N-methylphosphoramidocyanidate

Methyl ethyl(methyl)amidocyanidophosphate

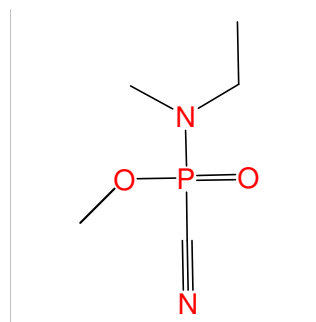

**Chemical name:** Methyl N-methyl-N-propylphosphoramidocyanidate

Schedule: 1A02

CAS RN: 870124-41-7

HS code: 2931.39

Key: 870124-41-7

Molecular formula: C<sub>6</sub>H<sub>13</sub>N<sub>2</sub>O<sub>2</sub>P

CAS Index Name: Phosphoramidocyanidic acid, methylpropyl-, methyl ester

**IUPAC name:** Methyl methylpropylphosphoramidocyanidoate

Synonyms: Phosphoramidocyanidic acid, N-methyl-N-propyl-, methyl ester

O-Methyl N-methyl-N-propylphosphoramidocyanidate

Methyl methyl(propyl)amidocyanidophosphate

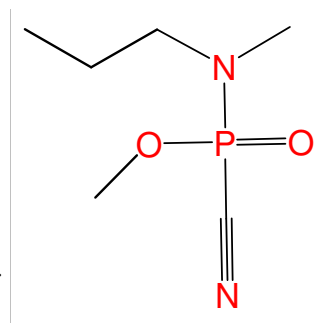

**Chemical name:** Methyl N-isopropyl-N-methylphosphoramidocyanidate

Schedule: 1A02

CAS RN: 870124-42-8

HS code: 2931.39

Key: 870124-42-8

Molecular formula: C<sub>6</sub>H<sub>13</sub>N<sub>2</sub>O<sub>2</sub>P

CAS Index Name: Phosphoramidocyanidic acid, (1-methylethyl)methyl-, methyl ester

**IUPAC name:** Methyl isopropylmethylphosphoramidocyanidoate

Synonyms: Phosphoramidocyanidic acid, N-methyl-N-1-methylethyl-, methyl ester

O-Methyl N-isopropyl-N-methylphosphoramidocyanidate

Methyl isopropyl(methyl)amidocyanidophosphate

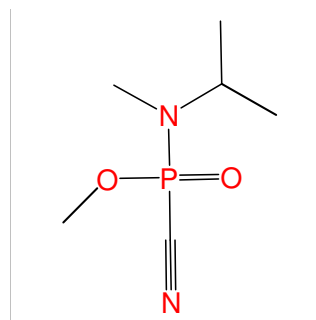

**Chemical name:** Methyl N,N-diethylphosphoramidocyanidate

Schedule: 1A02

CAS RN: 870124-43-9

HS code: 2931.39

Key: 870124-43-9

Molecular formula: C<sub>6</sub>H<sub>13</sub>N<sub>2</sub>O<sub>2</sub>P

CAS Index Name: Phosphoramidocyanidic acid, diethyl-, methyl ester

**IUPAC name:** Methyl diethylphosphoramidocyanidoate

Synonyms: Phosphoramidocyanidic acid, N,N-diethyl-, methyl ester

O-Methyl N,N-diethylphosphoramidocyanidate

Methyl diethylamidocyanidophosphate

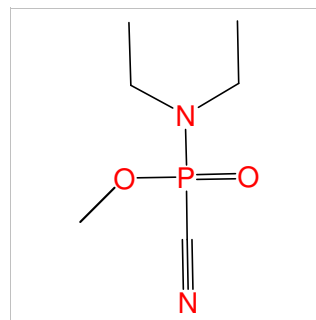

**Chemical name:** Methyl N-ethyl-N-isopropylphosphoramidocyanidate

Schedule: 1A02

CAS RN: 870124-44-0

HS code: 2931.39

Key: 870124-44-0

Molecular formula: C<sub>7</sub>H<sub>15</sub>N<sub>2</sub>O<sub>2</sub>P

CAS Index Name: Phosphoramidocyanidic acid, ethyl(1-methylethyl)-, methyl ester

**IUPAC name:** Methyl ethyl(isopropyl)phosphoramidocyanidate

Synonyms:

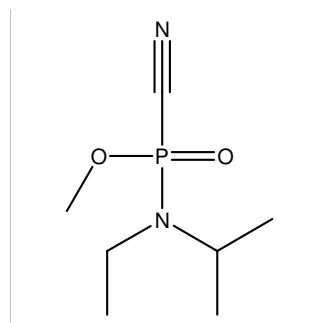

**Chemical name:** Methyl N-ethyl-N-propylphosphoramidocyanidate

Schedule: 1A02

CAS RN: 870124-45-1

HS code: 2931.39

Key: 870124-45-1

Molecular formula: C<sub>7</sub>H<sub>15</sub>N<sub>2</sub>O<sub>2</sub>P

CAS Index Name: Phosphoramidocyanidic acid, ethylpropyl-,methyl ester

**IUPAC name:** Methyl ethylpropylphosphoramidocyanidoate

Synonyms: Phosphoramidocyanidic acid, N-ethyl-N-propyl-, methyl ester

O-Methyl N-ethyl-N-propylphosphoramidocyanidate

Methyl ethyl(propyl)amidocyanidophosphate

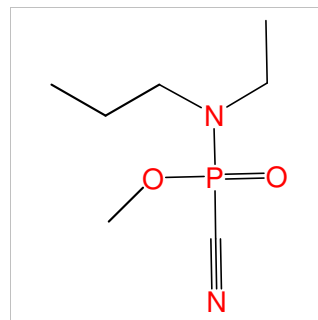

**Chemical name:** Methyl N,N-dipropylphosphoramidocyanidate

Schedule: 1A02

CAS RN: 870124-46-2

HS code: 2931.39

Key: 870124-46-2

Molecular formula: C<sub>8</sub>H<sub>17</sub>N<sub>2</sub>O<sub>2</sub>P

CAS Index Name: Phosphoramidocyanidic acid, dipropyl-, methyl ester

**IUPAC name:** Methyl dipropylphosphoramidocyanidoate

Synonyms: Phosphoramidocyanidic acid, N,N-dipropyl-, methyl ester

O-Methyl N,N-dipropylphosphoramidocyanidate

Methyl dipropylamidocyanidophosphate

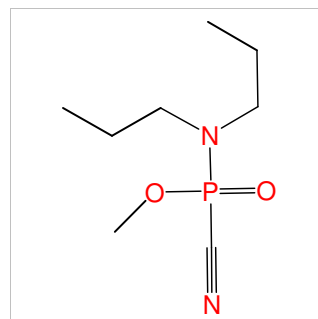

**Chemical name:** Methyl N,N-diisopropylphosphoramidocyanidate

Schedule: 1A02

CAS RN: 870124-47-3

HS code: 2931.39

Key: 870124-47-3

Molecular formula: C<sub>8</sub>H<sub>17</sub>N<sub>2</sub>O<sub>2</sub>P

CAS Index Name: Phosphoramidocyanidic acid, bis(1-methylethyl)-, methyl ester

**IUPAC name:** Methyl diisopropylphosphoramidocyanidoate

Synonyms: Phosphoramidocyanidic acid, N,N-[bis-(1-methylethyl)]-, methyl ester

Phosphoramidocyanidic acid, N,N-[bis(1-methylethyl)]-, methyl ester

O-Methyl N,N-diisopropylphosphoramidocyanidate

Methyl diisopropylamidocyanidophosphate

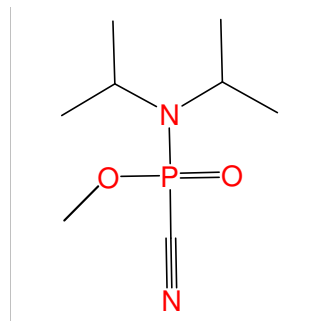

**Chemical name:** Methyl N-isopropyl-N-propylphosphoramidocyanidate

Schedule: 1A02

CAS RN: 870124-48-4

HS code: 2931.39

Key: 870124-48-4

Molecular formula: C<sub>8</sub>H<sub>17</sub>N<sub>2</sub>O<sub>2</sub>P

CAS Index Name: Phosphoramidocyanidic acid, (1-methylethyl)propyl-, methyl ester

**IUPAC name:** Methyl isopropylpropylphosphoramidocyanidoate

Synonyms: Phosphoramidocyanidic acid, N-1-methylethyl-N-propyl-, methyl ester

O-Methyl N-isopropyl-N-propylphosphoramidocyanidate

Methyl isopropyl(propyl)amidocyanidophosphate

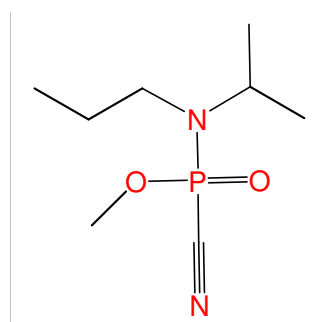

**Chemical name:** Pentyl N,N-dipropylphosphoramidocyanidate

Schedule: 1A02

CAS RN: 959014-75-6

HS code: 2931.39

Key: 959014-75-6

Molecular formula: C<sub>12</sub>H<sub>25</sub>N<sub>2</sub>O<sub>2</sub>P

CAS Index Name: Phosphoramidocyanidic acid, dipropyl-, pentyl ester

**IUPAC name:** Pentyl dipropylphosphoramidocyanidate

Synonyms: Pentyl dipropylamidocyanidophosphate

O-Pentyl N,N-dipropylphosphoramidocyanidate

n-Pentyl N,N-dipropylphosphoramidocyanidate

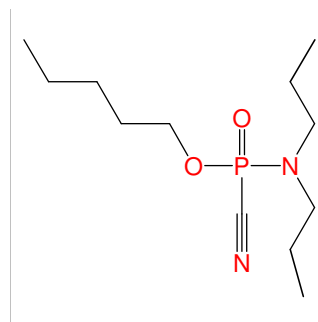

**Chemical name:** Cyclooctyl N,N-dipropylphosphoramidocyanidate

Schedule: 1A02

CAS RN: 959220-91-8

HS code: 2931.39

Key: 959220-91-8

Molecular formula: C<sub>15</sub>H<sub>29</sub>N<sub>2</sub>O<sub>2</sub>P

CAS Index Name: Phosphoramidocyanidic acid, dipropyl-, cyclooctyl ester

**IUPAC name:** Cyclooctyl dipropylphosphoramidocyanidoate

Synonyms: Phosphoramidocyanidic acid, N,N-dipropyl-, cyclooctyl ester

O-Cyclooctyl N,N-dipropylphosphoramidocyanidate

Cyclooctyl dipropylamidocyanidophosphate

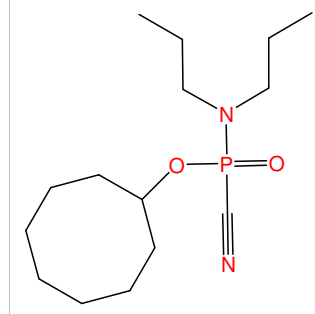

**Chemical name:** Cycloheptyl N,N-dipropylphosphoramidocyanidate

Schedule: 1A02

CAS RN: 959220-92-9

HS code: 2931.39

Key: 959220-92-9

Molecular formula: C<sub>14</sub>H<sub>27</sub>N<sub>2</sub>O<sub>2</sub>P

CAS Index Name: Phosphoramidocyanidic acid, dipropyl-, cycloheptyl ester

**IUPAC name:** Cycloheptyl dipropylphosphoramidocyanidoate

Synonyms: Phosphoramidocyanidic acid, N,N-dipropyl-, cycloheptyl ester

O-Cycloheptyl N,N-dipropylphosphoramidocyanidate

Cycloheptyl dipropylamidocyanidophosphate

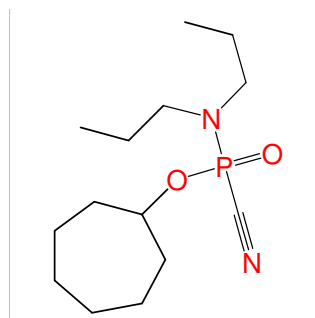

**Chemical name:** 2-Cyclohexylethyl N,N-diisopropylphosphoramidocyanidate

Schedule: 1A02

CAS RN: 959231-14-2

HS code: 2931.39

Key: 959231-14-2

Molecular formula: C<sub>15</sub>H<sub>29</sub>N<sub>2</sub>O<sub>2</sub>P

CAS Index Name: Phosphoramidocyanidic acid, bis(1-methylethyl)-, 2-cyclohexylethyl ester

**IUPAC name:** 2-Cyclohexylethyl diisopropylphosphoramidocyanidoate

Synonyms: O-2-Cyclohexylethyl N,N-diisopropylphosphoramidocyanidate

2-Cyclohexylethyl diisopropylamidocyanidophosphate

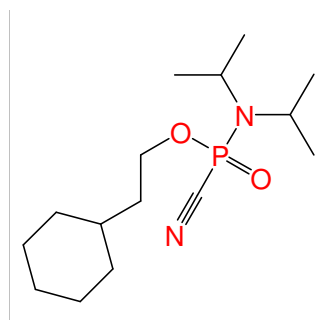

**Chemical name:** Propyl N,N-diisopropylphosphoramidocyanidate

Schedule: 1A02

CAS RN: 959231-16-4

HS code: 2931.39

Key: 959231-16-4

Molecular formula: C<sub>10</sub>H<sub>21</sub>N<sub>2</sub>O<sub>2</sub>P

CAS Index Name: Phosphoramidocyanidic acid, bis(1-methylethyl)-, propyl ester

**IUPAC name:** Propyl diisopropylphosphoramidocyanidoate

Synonyms: Propyl diisopropylamidocyanidophosphate

Phosphoramidocyanidic acid, bis(N-1-methylethyl)-, propyl ester

O-Propyl N,N-diisopropylphosphoramidocyanidate

O-n-Propyl N,N-diisopropylphosphoramidocyanidate

n-Propyl N,N-diisopropylphosphoramidocyanidate

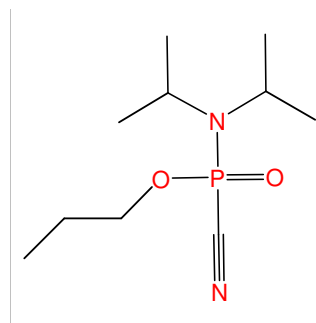

**Chemical name:** Pentyl N,N-diisopropylphosphoramidocyanidate

Schedule: 1A02

CAS RN: 959231-39-1

HS code: 2931.39

Key: 959231-39-1

Molecular formula: C<sub>12</sub>H<sub>25</sub>N<sub>2</sub>O<sub>2</sub>P

CAS Index Name: Phosphoramidocyanidic acid, bis(1-methylethyl)-, pentyl ester

**IUPAC name:** Pentyl diisopropylphosphoramidocyanidate

Synonyms: Pentyl diisopropylamidocyanidophosphate

O-Pentyl N,N-diisopropylphosphoramidocyanidate

n-Pentyl N,N-diisopropylphosphoramidocyanidate

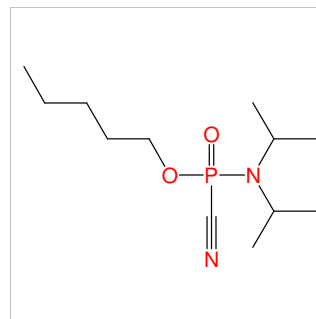

**Chemical name:** Heptyl N,N-diisopropylphosphoramidocyanidate

Schedule: 1A02

CAS RN: 959231-41-5

HS code: 2931.39

Key: 959231-41-5

Molecular formula: C<sub>14</sub>H<sub>29</sub>N<sub>2</sub>O<sub>2</sub>P

CAS Index Name: Phosphoramidocyanidic acid, bis(1-methylethyl)-, heptyl ester

**IUPAC name:** Heptyl diisopropylphosphoramidocyanidoate

Synonyms: O-Heptyl N,N-diisopropylphosphoramidocyanidate

n-Heptyl N,N-diisopropylphosphoramidocyanidate

Heptyl N,N-diisopropylamidocyanidophosphate

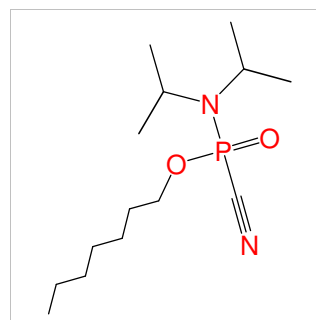

**Chemical name:** Cyclohexylmethyl N,N-dipropylphosphoramidocyanidate

Schedule: 1A02

CAS RN: 959285-51-9

HS code: 2931.39

Key: 959285-51-9

Molecular formula: C<sub>14</sub>H<sub>27</sub>N<sub>2</sub>O<sub>2</sub>P

CAS Index Name: Phosphoramidocyanidic acid, dipropyl-, cyclohexylmethyl ester

**IUPAC name:** Cyclohexylmethyl dipropylphosphoramidocyanidoate

Synonyms: O-Cyclohexylmethyl N,N-dipropylphosphoramidocyanidate

Cyclohexylmethyl dipropylamidocyanidophosphate

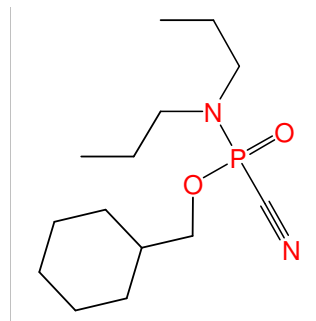

**Chemical name:** Cyclooctyl N,N-diisopropylphosphoramidocyanidate

Schedule: 1A02

CAS RN: 959299-70-8

HS code: 2931.39

Key: 959299-70-8

Molecular formula: C<sub>15</sub>H<sub>29</sub>N<sub>2</sub>O<sub>2</sub>P

CAS Index Name: Phosphoramidocyanidic acid, bis(1-methylethyl)-, cyclooctyl ester

**IUPAC name:** Cyclooctyl diisopropylphosphoramidocyanidoate

Synonyms: O-Cyclooctyl N,N-diisopropylphosphoramidocyanidate

Cyclooctyl diisopropylamidocyanidophosphate

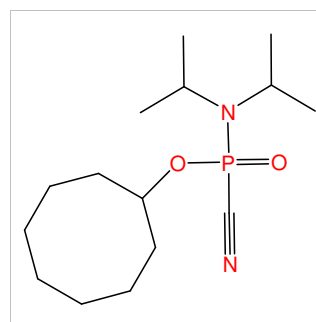

**Chemical name:** Cycloheptyl N,N-diisopropylphosphoramidocyanidate

Schedule: 1A02

CAS RN: 959299-72-0

HS code: 2931.39

Key: 959299-72-0

Molecular formula: C<sub>14</sub>H<sub>27</sub>N<sub>2</sub>O<sub>2</sub>P

CAS Index Name: Phosphoramidocyanidic acid, bis(1-methylethyl)-, cycloheptyl ester

**IUPAC name:** Cycloheptyl diisopropylphosphoramidocyanidoate

Synonyms: Phosphoramidocyanidic acid, bis(N-1-methylethyl)-, cycloheptyl ester

O-Cycloheptyl N,N-diisopropylphosphoramidocyanidate

Cycloheptyl diisopropylamidocyanidophosphate

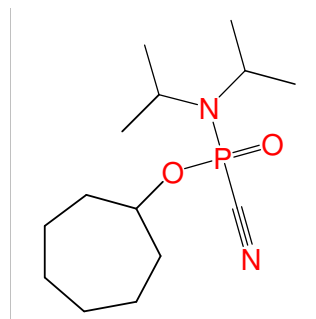



**Chemical name:** Heptyl N,N-dipropylphosphoramidocyanidate

Schedule: 1A02

CAS RN: 959304-97-3

HS code: 2931.39

Key: 959304-97-3

Molecular formula: C<sub>14</sub>H<sub>29</sub>N<sub>2</sub>O<sub>2</sub>P

CAS Index Name: Phosphoramidocyanidic acid, dipropyl-, heptyl ester

**IUPAC name:** Heptyl dipropylphosphoramidocyanidoate

Synonyms: O-Heptyl N,N-dipropylphosphoramidocyanidate

n-Heptyl N,N-dipropylphosphoramidocyanidate

Heptyl N,N-dipropylamidocyanidophosphate

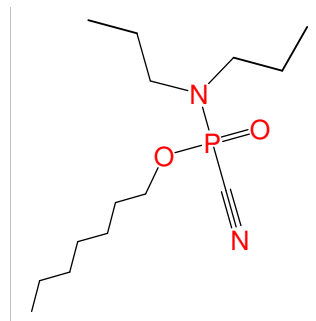

**Chemical name:** 2-Cyclohexylethyl N,N-dipropylphosphoramidocyanidate

Schedule: 1A02

CAS RN: 959304-98-4

HS code: 2931.39

Key: 959304-98-4

Molecular formula: C<sub>15</sub>H<sub>29</sub>N<sub>2</sub>O<sub>2</sub>P

CAS Index Name: Phosphoramidocyanidic acid, dipropyl-, 2-cyclohexylethyl ester

**IUPAC name:** 2-Cyclohexylethyl dipropylphosphoramidocyanidoate

Synonyms: O-2-Cyclohexylethyl N,N-dipropylphosphoramidocyanidate

2-Cyclohexylethyl dipropylamidocyanidophosphate

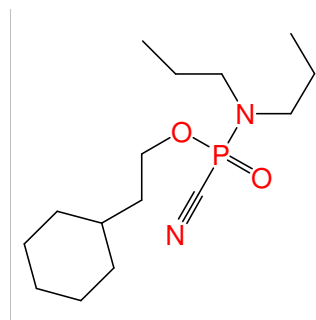

**Chemical name:** Cyclopentyl N,N-dipropylphosphoramidocyanidate

Schedule: 1A02

CAS RN: 959305-00-1

HS code: 2931.39

Key: 959305-00-1

Molecular formula: C<sub>12</sub>H<sub>23</sub>N<sub>2</sub>O<sub>2</sub>P

CAS Index Name: Phosphoramidocyanidic acid, dipropyl-, cyclopentyl ester

**IUPAC name:** Cyclopentyl dipropylphosphoramidocyanidoate

Synonyms: O-Cyclopentyl N,N-dipropylphosphoramidocyanidate

Cyclopentyl dipropylamidocyanidophosphate

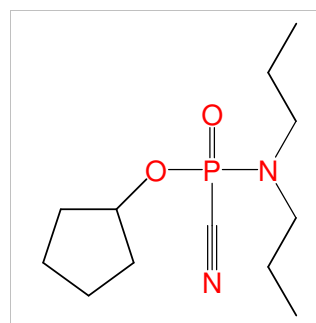

**Chemical name:** Cyclohexylmethyl S-2-isopropylmethylaminoethyl isopropylphosphonothiolate

Schedule: 1A03

CAS RN: HS code: 2930.90

Key: (100-49-2)-I1A3-IM

Molecular formula: C<sub>16</sub>H<sub>34</sub>NO<sub>2</sub>PS

CAS Index Name: Phosphonothioic acid, 1-methylethyl-, S-[2-((1-methylethyl)methylamino)ethyl] O-cyclohexylmethyl ester

**IUPAC name:** Cyclohexylmethyl S-2-isopropylmethylaminoethyl isopropylphosphonothioate

Synonyms: O-Cyclohexylmethyl S-2-isopropylmethylaminoethyl isopropylphosphonothiolate  
Cyclohexylmethyl S-2-(isopropylmethylamino)ethyl isopropylphosphonothiolate

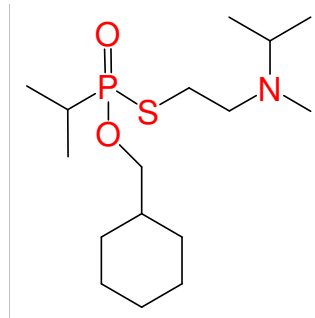

**Chemical name:** Cyclohexylmethyl S-2-diethylaminoethyl methylphosphonothiolate

Schedule: 1A03

CAS RN: HS code: 2930.90

Key: (100-49-2)-M1A3-EE

Molecular formula: C<sub>14</sub>H<sub>30</sub>NO<sub>2</sub>PS

CAS Index Name:

**IUPAC name:**

Synonyms:

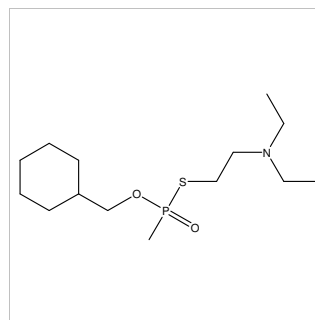

**Chemical name:** Cyclohexylmethyl S-2-dipropylaminoethyl methylphosphonothiolate

Schedule: 1A03

CAS RN: HS code: 2930.90

Key: (100-49-2)-M1A3-PP

Molecular formula: C<sub>16</sub>H<sub>34</sub>NO<sub>2</sub>PS

CAS Index Name:

**IUPAC name:**

Synonyms:

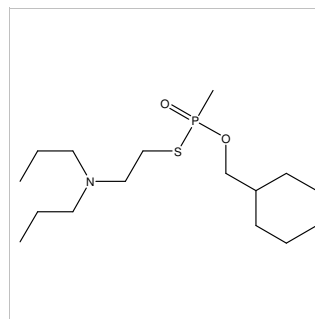

**Chemical name:** 3,7-Dimethyloctyl S-2-diethylaminoethyl methylphosphonothiolate

Schedule: 1A03

CAS RN: HS code: 2930.90

Key: (106-21-8)-M1A3-EE

Molecular formula: C<sub>17</sub>H<sub>38</sub>NO<sub>2</sub>PS

CAS Index Name:

**IUPAC name:**

Synonyms:

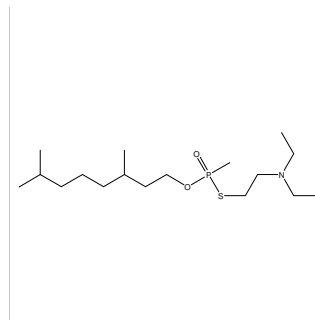

**Chemical name:** 1,3-Dimethylbutyl S-2-diethylaminoethyl ethylphosphonothiolate

Schedule: 1A03

CAS RN:

HS code: 2930.90

Key: (108-11-2)-E1A3-EE

Molecular formula: C<sub>14</sub>H<sub>32</sub>NO<sub>2</sub>PS

CAS Index Name:

**IUPAC name:**

Synonyms:

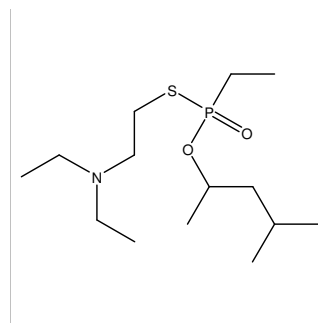

**Chemical name:** 1,3-Dimethylbutyl S-2-dipropylaminoethyl ethylphosphonothiolate

Schedule: 1A03

CAS RN:

HS code: 2930.90

Key: (108-11-2)-E1A3-PP

Molecular formula: C<sub>16</sub>H<sub>36</sub>NO<sub>2</sub>PS

CAS Index Name:

**IUPAC name:**

Synonyms:

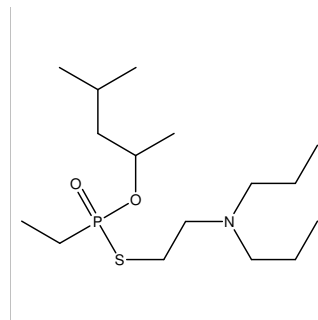

**Chemical name:** 1,3-Dimethylbutyl S-2-diethylaminoethyl methylphosphonothiolate

Schedule: 1A03

CAS RN:

HS code: 2930.90

Key: (108-11-2)-M1A3-EE

Molecular formula: C<sub>13</sub>H<sub>30</sub>NO<sub>2</sub>PS

CAS Index Name:

**IUPAC name:**

Synonyms:

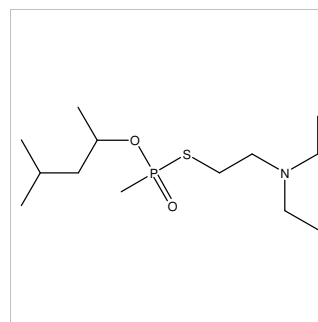

**Chemical name:** 1,3-Dimethylbutyl S-2-dipropylaminoethyl methylphosphonothiolate

Schedule: 1A03

CAS RN:

HS code: 2930.90

Key: (108-11-2)-M1A3-PP

Molecular formula: C<sub>15</sub>H<sub>34</sub>NO<sub>2</sub>PS

CAS Index Name:

**IUPAC name:**

Synonyms:

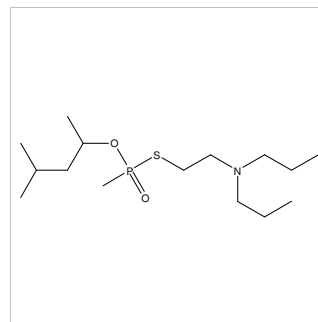

**Chemical name:** 1,3-Dimethylbutyl S-2-dipropylaminoethyl propylphosphonothiolate

Schedule: 1A03

CAS RN: HS code: 2930.90

Key: (108-11-2)-P1A3-PP

Molecular formula: C<sub>17</sub>H<sub>38</sub>NO<sub>2</sub>PS

CAS Index Name:

**IUPAC name:**

Synonyms:

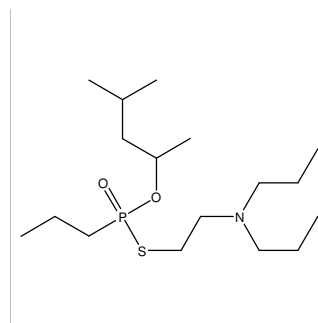

**Chemical name:** Cyclohexyl S-2-N-ethyl-N-isopropylaminoethyl ethylphosphonate

Schedule: 1A03

CAS RN: HS code: 2930.90

Key: (108-93-0)-E1A3-EI

Molecular formula: C<sub>15</sub>H<sub>32</sub>NO<sub>2</sub>PS

CAS Index Name:

**IUPAC name:**

Synonyms:

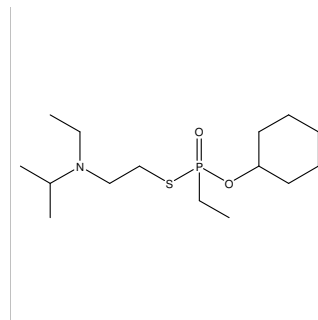

**Chemical name:** Cyclohexyl S-2-N-ethyl-N-methylaminoethyl ethylphosphonothiolate

Schedule: 1A03

CAS RN: HS code: 2930.90

Key: (108-93-0)-E1A3-EM

Molecular formula: C<sub>13</sub>H<sub>28</sub>NO<sub>2</sub>PS

CAS Index Name:

**IUPAC name:**

Synonyms:

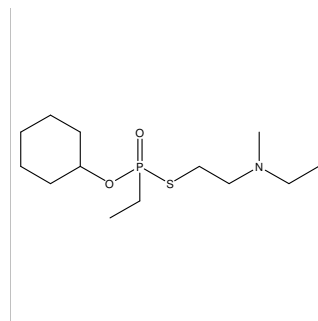

**Chemical name:** Cyclohexyl S-2-N-ethyl-N-propylaminoethyl ethylphosphonate

Schedule: 1A03

CAS RN: HS code: 2930.90

Key: (108-93-0)-E1A3-EP

Molecular formula: C<sub>15</sub>H<sub>32</sub>NO<sub>2</sub>PS

CAS Index Name:

**IUPAC name:**

Synonyms:

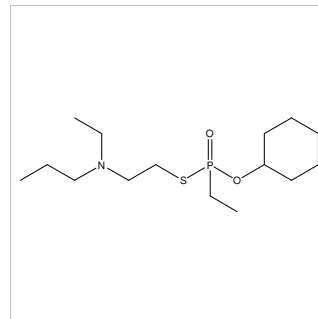

**Chemical name:** Cyclohexyl S-2-N-isopropyl-N-methylaminoethyl ethylphosphonate

Schedule: 1A03

CAS RN: HS code: 2930.90

Key: (108-93-0)-E1A3-IM

Molecular formula: C<sub>14</sub>H<sub>30</sub>NO<sub>2</sub>PS

CAS Index Name:

**IUPAC name:**

Synonyms:

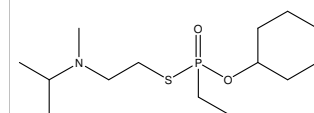

**Chemical name:** Cyclohexyl S-2-N-isopropyl-N-propylaminoethyl ethylphosphonothiolate

Schedule: 1A03

CAS RN: HS code: 2930.90

Key: (108-93-0)-E1A3-IP

Molecular formula: C<sub>16</sub>H<sub>34</sub>NO<sub>2</sub>PS

CAS Index Name:

**IUPAC name:**

Synonyms:

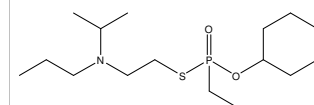

**Chemical name:** Cyclohexyl S-2-N-methyl-N-propylaminoethyl ethylphosphonothiolate

Schedule: 1A03

CAS RN: HS code: 2930.90

Key: (108-93-0)-E1A3-MP

Molecular formula: C<sub>14</sub>H<sub>30</sub>NO<sub>2</sub>PS

CAS Index Name:

**IUPAC name:**

Synonyms:

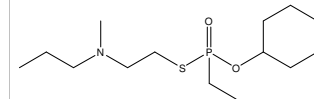

**Chemical name:** Cyclohexyl S-2-N-ethyl-N-isopropylaminoethyl isopropylphosphonothiolate

Schedule: 1A03

CAS RN: HS code: 2930.90

Key: (108-93-0)-I1A3-EI

Molecular formula: C<sub>16</sub>H<sub>34</sub>NO<sub>2</sub>PS

CAS Index Name:

**IUPAC name:**

Synonyms:

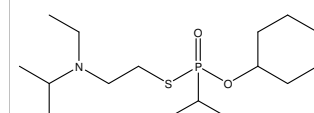

**Chemical name:** Cyclohexyl S-2-N-ethyl-N-methylaminoethyl isopropylphosphonothiolate

Schedule: 1A03

CAS RN: HS code: 2930.90

Key: (108-93-0)-I1A3-EM

Molecular formula: C<sub>14</sub>H<sub>30</sub>NO<sub>2</sub>PS

CAS Index Name:

**IUPAC name:**

Synonyms:

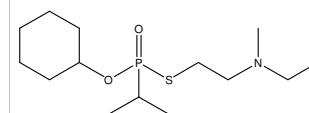

**Chemical name:** Cyclohexyl S-2-N-ethyl-N-propylaminoethyl isopropylphosphonothiolate

Schedule: 1A03

CAS RN: HS code: 2930.90

Key: (108-93-0)-I1A3-EP

Molecular formula: C<sub>16</sub>H<sub>34</sub>NO<sub>2</sub>PS

CAS Index Name:

**IUPAC name:**

Synonyms:

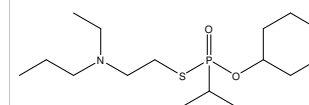

**Chemical name:** Cyclohexyl S-2-diisopropylaminoethyl isopropylphosphonothiolate

Schedule: 1A03

CAS RN: HS code: 2930.90

Key: (108-93-0)-I1A3-II

Molecular formula: C<sub>17</sub>H<sub>36</sub>NO<sub>2</sub>PS

CAS Index Name:

**IUPAC name:**

Synonyms:

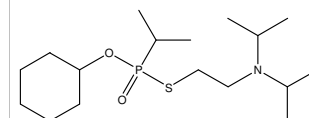

**Chemical name:** Cyclohexyl S-2-N-isopropyl-N-methylaminoethyl isopropylphosphonothiolate

Schedule: 1A03

CAS RN: HS code: 2930.90

Key: (108-93-0)-I1A3-IM

Molecular formula: C<sub>15</sub>H<sub>32</sub>NO<sub>2</sub>PS

CAS Index Name:

**IUPAC name:**

Synonyms:

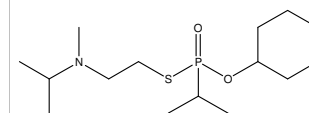

**Chemical name:** Cyclohexyl S-2-N-isopropyl-N-propylaminoethyl isopropylphosphonothiolate

Schedule: 1A03

CAS RN: HS code: 2930.90

Key: (108-93-0)-I1A3-IP

Molecular formula: C<sub>17</sub>H<sub>36</sub>NO<sub>2</sub>PS

CAS Index Name:

**IUPAC name:**

Synonyms:

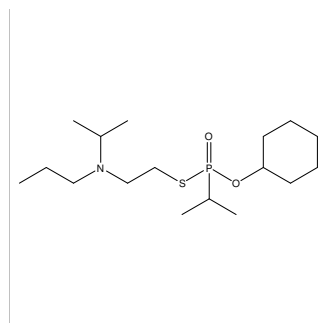

**Chemical name:** Cyclohexyl S-2-dimethylaminoethyl isopropylphosphonothiolate

Schedule: 1A03

CAS RN: HS code: 2930.90

Key: (108-93-0)-I1A3-MM

Molecular formula: C<sub>13</sub>H<sub>28</sub>NO<sub>2</sub>PS

CAS Index Name:

**IUPAC name:**

Synonyms:

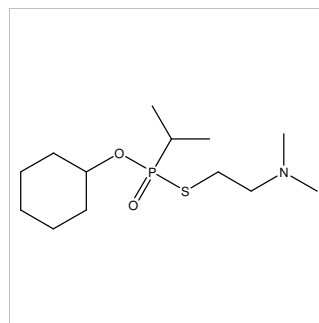

**Chemical name:** Cyclohexyl S-2-N-methyl-N-propylaminoethyl isopropylphosphonothiolate

Schedule: 1A03

CAS RN: HS code: 2930.90

Key: (108-93-0)-I1A3-MP

Molecular formula: C<sub>15</sub>H<sub>32</sub>NO<sub>2</sub>PS

CAS Index Name:

**IUPAC name:**

Synonyms:

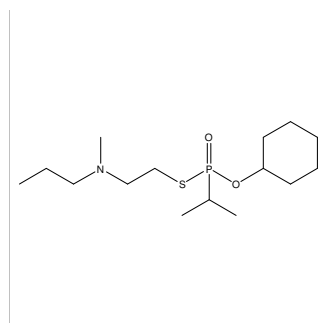

**Chemical name:** Cyclohexyl S-2-dipropylaminoethyl isopropylphosphonothiolate

Schedule: 1A03

CAS RN: HS code: 2930.90

Key: (108-93-0)-I1A3-PP

Molecular formula: C<sub>17</sub>H<sub>36</sub>NO<sub>2</sub>PS

CAS Index Name:

**IUPAC name:**

Synonyms:

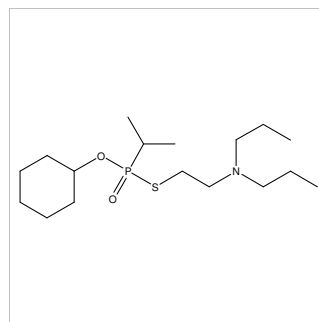

**Chemical name:** Cyclohexyl S-2-N-ethyl-N-isopropylaminoethyl methylphosphonothiolate

Schedule: 1A03

CAS RN: HS code: 2930.90

Key: (108-93-0)-M1A3-EI

Molecular formula: C<sub>14</sub>H<sub>30</sub>NO<sub>2</sub>PS

CAS Index Name:

**IUPAC name:**

Synonyms:

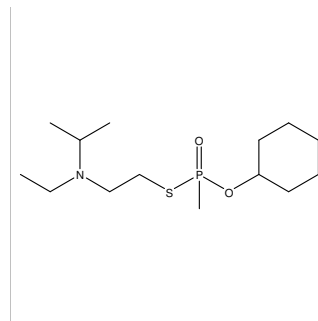

**Chemical name:** Cyclohexyl S-2-N-ethyl-N-methylaminoethyl methylphosphonothiolate

Schedule: 1A03

CAS RN: HS code: 2930.90

Key: (108-93-0)-M1A3-EM

Molecular formula: C<sub>12</sub>H<sub>26</sub>NO<sub>2</sub>PS

CAS Index Name:

**IUPAC name:**

Synonyms:

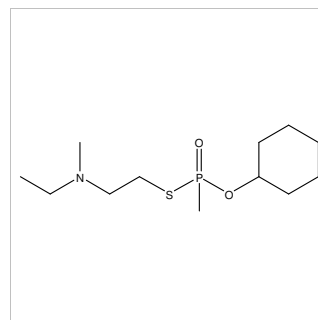

**Chemical name:** Cyclohexyl S-2-N-ethyl-N-propylaminoethyl methylphosphonothiolate

Schedule: 1A03

CAS RN: HS code: 2930.90

Key: (108-93-0)-M1A3-EP

Molecular formula: C<sub>14</sub>H<sub>30</sub>NO<sub>2</sub>PS

CAS Index Name:

**IUPAC name:**

Synonyms:

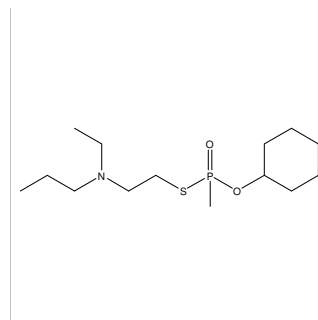

**Chemical name:** Cyclohexyl S-2-N-isopropyl-N-methylaminoethyl methylphosphonothiolate

Schedule: 1A03

CAS RN: HS code: 2930.90

Key: (108-93-0)-M1A3-IM

Molecular formula: C<sub>13</sub>H<sub>28</sub>NO<sub>2</sub>PS

CAS Index Name:

**IUPAC name:**

Synonyms:

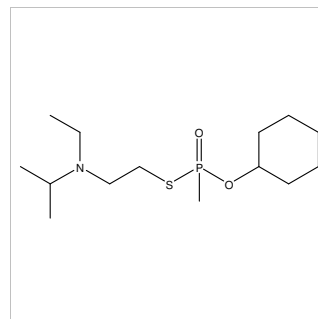



**Chemical name:** Cyclohexyl S-2-N-isopropyl-N-propylaminoethyl methylphosphonothiolate

Schedule: 1A03

CAS RN: HS code: 2930.90

Key: (108-93-0)-M1A3-IP

Molecular formula: C<sub>15</sub>H<sub>32</sub>NO<sub>2</sub>PS

CAS Index Name:

**IUPAC name:**

Synonyms:

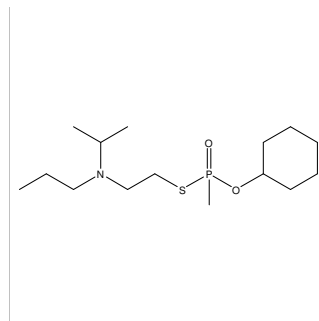

**Chemical name:** Cyclohexyl S-2-N-methyl-N-propylaminoethyl methylphosphonothiolate

Schedule: 1A03

CAS RN: HS code: 2930.90

Key: (108-93-0)-M1A3-MP

Molecular formula: C<sub>13</sub>H<sub>28</sub>NO<sub>2</sub>PS

CAS Index Name:

**IUPAC name:**

Synonyms:

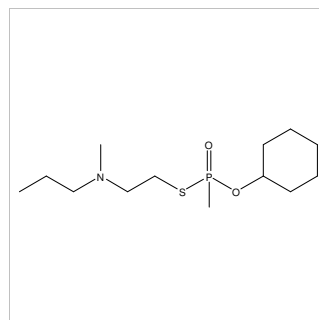

**Chemical name:** Cyclohexyl S-2-N-ethyl-N-isopropylaminoethyl propylphosphonothiolate

Schedule: 1A03

CAS RN: HS code: 2930.90

Key: (108-93-0)-P1A3-EI

Molecular formula: C<sub>16</sub>H<sub>34</sub>NO<sub>2</sub>PS

CAS Index Name:

**IUPAC name:**

Synonyms:

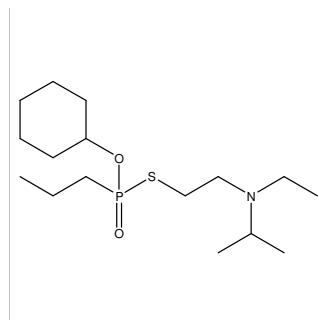

**Chemical name:** Cyclohexyl S-2-N-ethyl-N-methylaminoethyl propylphosphonothiolate

Schedule: 1A03

CAS RN: HS code: 2930.90

Key: (108-93-0)-P1A3-EM

Molecular formula: C<sub>14</sub>H<sub>30</sub>NO<sub>2</sub>PS

CAS Index Name:

**IUPAC name:**

Synonyms:

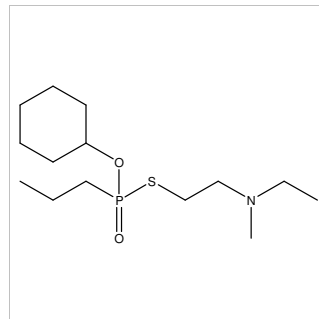

**Chemical name:** Cyclohexyl S-2-N-ethyl-N-propylaminoethyl propylphosphonothiolate

Schedule: 1A03

CAS RN: HS code: 2930.90

Key: (108-93-0)-P1A3-EP

Molecular formula: C<sub>16</sub>H<sub>34</sub>NO<sub>2</sub>PS

CAS Index Name:

**IUPAC name:**

Synonyms:

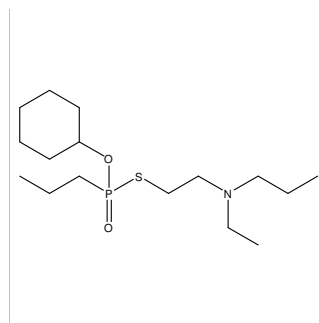

**Chemical name:** Cyclohexyl S-2-N-isopropyl-N-methylaminoethyl propylphosphonothiolate

Schedule: 1A03

CAS RN: HS code: 2930.90

Key: (108-93-0)-P1A3-IM

Molecular formula: C<sub>15</sub>H<sub>32</sub>NO<sub>2</sub>PS

CAS Index Name:

**IUPAC name:**

Synonyms:

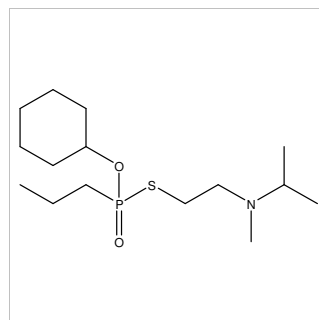

**Chemical name:** Cyclohexyl S-2-N-isopropyl-N-propylaminoethyl propylphosphonothiolate

Schedule: 1A03

CAS RN: HS code: 2930.90

Key: (108-93-0)-P1A3-IP

Molecular formula: C<sub>17</sub>H<sub>36</sub>NO<sub>2</sub>PS

CAS Index Name:

**IUPAC name:**

Synonyms:

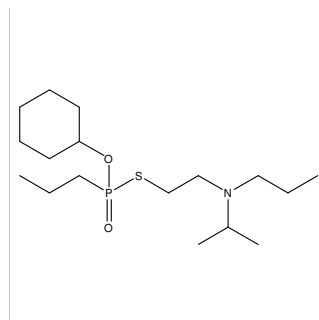

**Chemical name:** Cyclohexyl S-2-dimethylaminoethyl propylphosphonothiolate

Schedule: 1A03

CAS RN: HS code: 2930.90

Key: (108-93-0)-P1A3-MM

Molecular formula: C<sub>13</sub>H<sub>28</sub>NO<sub>2</sub>PS

CAS Index Name:

**IUPAC name:**

Synonyms:

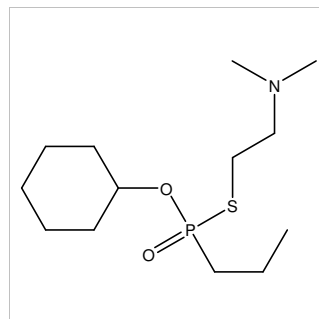

**Chemical name:** Cyclohexyl S-2-N-methyl-N-propylaminoethyl propylphosphonothiolate

Schedule: 1A03

CAS RN: HS code: 2930.90

Key: (108-93-0)-P1A3-MP

Molecular formula: C<sub>15</sub>H<sub>32</sub>NO<sub>2</sub>PS

CAS Index Name:

**IUPAC name:**

Synonyms:

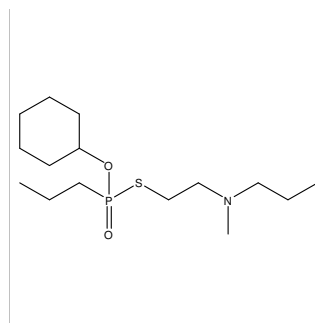

**Chemical name:** Hexyl S-2-dipropylaminoethyl ethylphosphonothiolate

Schedule: 1A03

CAS RN: HS code: 2930.90

Key: (111-27-3)-E1A3-PP

Molecular formula: C<sub>16</sub>H<sub>36</sub>NO<sub>2</sub>PS

CAS Index Name: Phosphonothioic acid, ethyl-, S-[2-(dipropylamino)ethyl] O-hexyl ester

**IUPAC name:** Hexyl S-2-dipropylaminoethyl ethylphosphonothioate

Synonyms: O-Hexyl S-2-dipropylaminoethyl ethylphosphonothiolate

Hexyl S-[2-(dipropylamino)ethyl] ethylphosphonothiolate

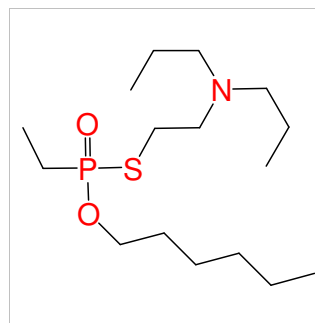

**Chemical name:** Hexyl S-2-dimethylaminoethyl isopropylphosphonothiolate

Schedule: 1A03

CAS RN: HS code: 2930.90

Key: (111-27-3)-I1A3-MM

Molecular formula: C<sub>13</sub>H<sub>30</sub>NO<sub>2</sub>PS

CAS Index Name:

**IUPAC name:**

Synonyms:

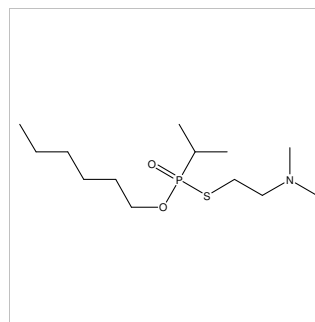

**Chemical name:** Hexyl S-2-dipropylaminoethyl isopropylphosphonothiolate

Schedule: 1A03

CAS RN: HS code: 2930.90

Key: (111-27-3)-I1A3-PP

Molecular formula: C<sub>17</sub>H<sub>38</sub>NO<sub>2</sub>PS

CAS Index Name:

**IUPAC name:**

Synonyms:

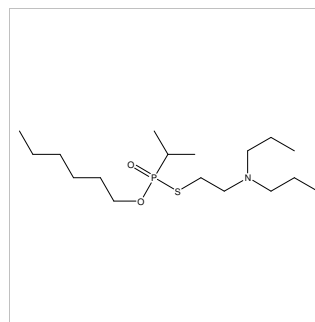

**Chemical name:** Hexyl S-2-diethylaminoethyl propylphosphonothiolate

Schedule: 1A03

CAS RN: HS code: 2930.90

Key: (111-27-3)-P1A3-EE

Molecular formula: C<sub>15</sub>H<sub>34</sub>NO<sub>2</sub>PS

CAS Index Name:

**IUPAC name:**

Synonyms:

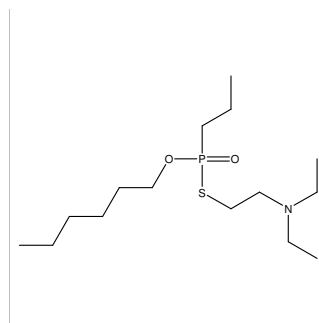

**Chemical name:** Hexyl S-2-dimethylaminoethyl propylphosphonothiolate

Schedule: 1A03

CAS RN: HS code: 2930.90

Key: (111-27-3)-P1A3-MM

Molecular formula: C<sub>13</sub>H<sub>30</sub>NO<sub>2</sub>PS

CAS Index Name:

**IUPAC name:**

Synonyms:

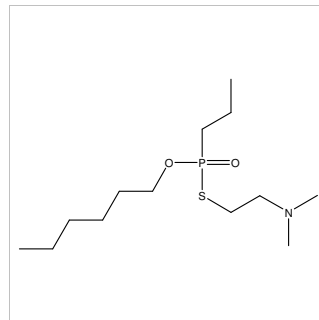

**Chemical name:** Hexyl S-2-dipropylaminoethyl propylphosphonothiolate

Schedule: 1A03

CAS RN: HS code: 2930.90

Key: (111-27-3)-P1A3-PP

Molecular formula: C<sub>17</sub>H<sub>38</sub>NO<sub>2</sub>PS

CAS Index Name:

**IUPAC name:**

Synonyms:

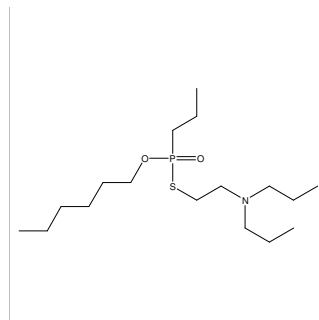

**Chemical name:** Heptyl S-2-diisopropylaminoethyl ethylphosphonothiolate

Schedule: 1A03

CAS RN: HS code: 2930.90

Key: (111-70-6)-E1A3-II

Molecular formula: C<sub>17</sub>H<sub>38</sub>NO<sub>2</sub>PS

CAS Index Name: Phosphonothioic acid, ethyl-, S-[2-(bis(1-methylethyl)amino)ethyl] O-heptyl ester

**IUPAC name:** Heptyl S-2-diisopropylaminoethyl ethylphosphonothioate

Synonyms: O-Heptyl S-2-diisopropylaminoethyl ethylphosphonothiolate

Heptyl S-[2-(bis-(1-methylethyl)amino)ethyl] ethylphosphonothiolate

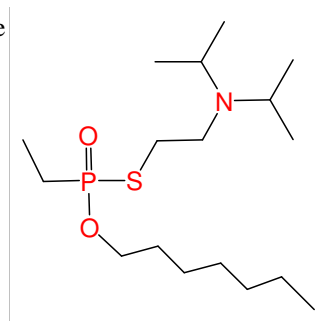

**Chemical name:** Heptyl S-2-dimethylaminoethyl ethylphosphonothiolate

Schedule: 1A03

CAS RN: HS code: 2930.90

Key: (111-70-6)-E1A3-MM

Molecular formula: C<sub>13</sub>H<sub>30</sub>NO<sub>2</sub>PS

CAS Index Name: Phosphonothioic acid, ethyl-, S-[2-(dimethylamino)ethyl] O-heptyl ester

**IUPAC name:** Heptyl S-2-dimethylaminoethyl ethylphosphonothioate

Synonyms: O-Heptyl S-2-dimethylaminoethyl ethylphosphonothiolate

Heptyl S-[2-(dimethylamino)ethyl] ethylphosphonothiolate

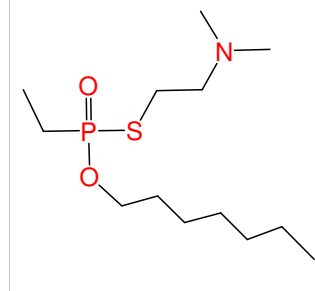

**Chemical name:** Heptyl S-2-dipropylaminoethyl isopropylphosphonothiolate

Schedule: 1A03

CAS RN: HS code: 2930.90

Key: (111-70-6)-I1A3-PP

Molecular formula: C<sub>18</sub>H<sub>40</sub>NO<sub>2</sub>PS

CAS Index Name:

**IUPAC name:**

Synonyms:

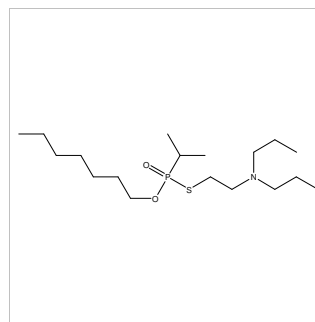

**Chemical name:** Heptyl S-2-diisopropylaminoethyl methylphosphonothiolate

Schedule: 1A03

CAS RN: HS code: 2930.90

Key: (111-70-6)-M1A3-II

Molecular formula: C<sub>16</sub>H<sub>36</sub>NO<sub>2</sub>PS

CAS Index Name: Phosphonothioic acid, methyl-, S-[2-(bis(1-methylethyl)amino)ethyl] O-heptyl ester

**IUPAC name:** Heptyl S-2-diisopropylaminoethyl methylphosphonothioate

Synonyms: O-Heptyl S-2-diisopropylaminoethyl methylphosphonothiolate

Heptyl S-[2-(diisopropyl)amino]ethyl methylphosphonothiolate

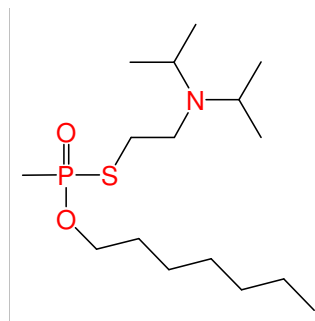

**Chemical name:** Heptyl S-2-diethylaminoethyl propylphosphonothiolate

Schedule: 1A03

CAS RN: HS code: 2930.90

Key: (111-70-6)-P1A3-EE

Molecular formula: C<sub>16</sub>H<sub>36</sub>NO<sub>2</sub>PS

CAS Index Name:

**IUPAC name:**

Synonyms:

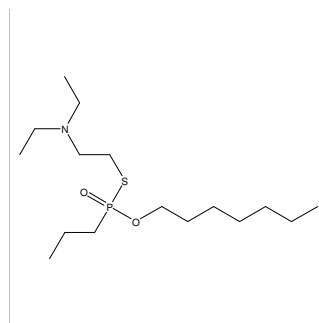

**Chemical name:** Octyl S-2-dipropylaminoethyl isopropylphosphonothiolate

Schedule: 1A03

CAS RN: HS code: 2930.90

Key: (111-87-5)-I1A3-PP

Molecular formula: C<sub>19</sub>H<sub>42</sub>NO<sub>2</sub>PS

CAS Index Name:

**IUPAC name:**

Synonyms:

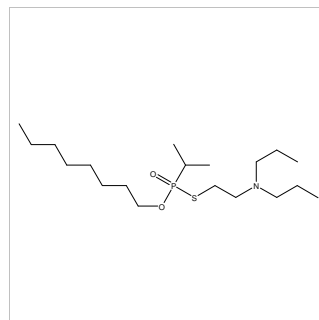

**Chemical name:** Octyl S-2-dimethylaminoethyl methylphosphonothiolate

Schedule: 1A03

CAS RN: HS code: 2930.90

Key: (111-87-5)-M1A3-MM

Molecular formula: C<sub>13</sub>H<sub>30</sub>NO<sub>2</sub>PS

CAS Index Name: Phosphonothioic acid, methyl-, S-[2-(dimethylamino)ethyl] O-octyl ester

**IUPAC name:** Octyl S-2-dimethylaminoethyl methylphosphonothioate

Synonyms: Octyl S-[2-(dimethylamino)ethyl] methylphosphonothiolate

O-Octyl S-2-dimethylaminoethyl methylphosphonothiolate

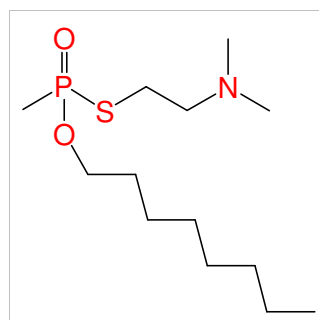

**Chemical name:** Octyl S-2-diethylaminoethyl propylphosphonothiolate

Schedule: 1A03

CAS RN: HS code: 2930.90

Key: (111-87-5)-P1A3-EE

Molecular formula: C<sub>17</sub>H<sub>38</sub>NO<sub>2</sub>PS

CAS Index Name:

**IUPAC name:**

Synonyms:

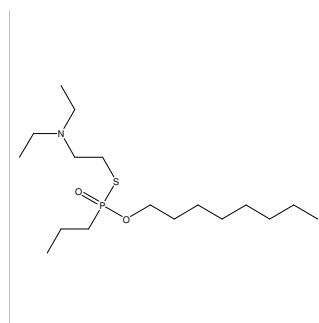

**Chemical name:** Decyl S-2-diethylaminoethyl isopropylphosphonothiolate

Schedule: 1A03

CAS RN: HS code: 2930.90

Key: (112-30-1)-I1A3-EE

Molecular formula: C<sub>19</sub>H<sub>42</sub>NO<sub>2</sub>PS

CAS Index Name:

**IUPAC name:**

Synonyms:

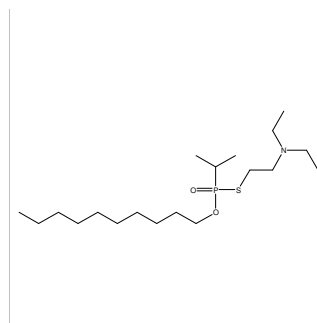

**Chemical name:** Decyl S-2-diethylaminoethyl propylphosphonothiolate

Schedule: 1A03

CAS RN: HS code: 2930.90

Key: (112-30-1)-P1A3-EE

Molecular formula: C<sub>19</sub>H<sub>42</sub>NO<sub>2</sub>PS

CAS Index Name:

**IUPAC name:**

Synonyms:

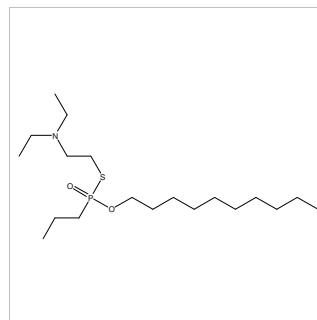

**Chemical name:** 3-Methylbutyl S-2-dipropylaminoethyl isopropylphosphonothiolate

Schedule: 1A03

CAS RN: HS code: 2930.90

Key: (123-51-3)-I1A3-PP

Molecular formula: C<sub>16</sub>H<sub>36</sub>NO<sub>2</sub>PS

CAS Index Name:

**IUPAC name:**

Synonyms:

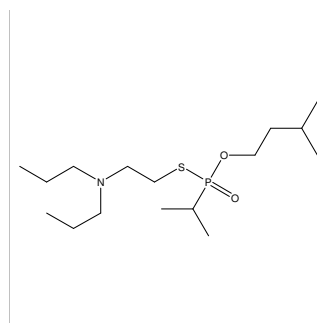

**Chemical name:** 2-tert-Butylcyclohexyl S-2-diisopropylaminoethyl isopropylphosphonothiolate

Schedule: 1A03

CAS RN: HS code: 2930.90

Key: (13491-79-7)-I1A3-II

Molecular formula: C<sub>21</sub>H<sub>44</sub>NO<sub>2</sub>PS

CAS Index Name: Phosphonothioic acid, 1-methylethyl-, S-[2-(bis(1-methylethyl)amino)ethyl] O-[2-(1,1-dimethylethyl)cyclohexyl] ester

**IUPAC name:** 2-tert-Butylcyclohexyl S-2-diisopropylaminoethyl isopropylphosphonothioate

Synonyms: O-2-tert-Butylcyclohexyl S-2-diisopropylaminoethyl isopropylphosphonothiolate

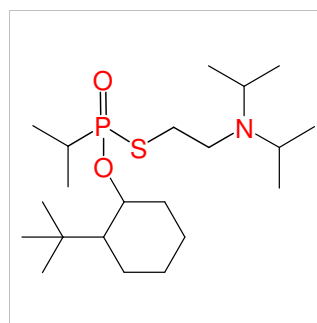

**Chemical name:** 2-tert-Butylcyclohexyl S-2-diisopropylaminoethyl propylphosphonothiolate

Schedule: 1A03

CAS RN: HS code: 2930.90

Key: (13491-79-7)-P1A3-II

Molecular formula: C<sub>21</sub>H<sub>44</sub>NO<sub>2</sub>PS

CAS Index Name: Phosphonothioic acid, propyl-, S-[2-(bis(1-methylethyl)amino)ethyl] O-[2-(1,1-dimethylethyl)cyclohexyl] ester

**IUPAC name:** 2-tert-Butylcyclohexyl S-2-diisopropylaminoethyl propylphosphonothioate

Synonyms: O-2-tert-Butylcyclohexyl S-2-diisopropylaminoethyl propylphosphonothiolate

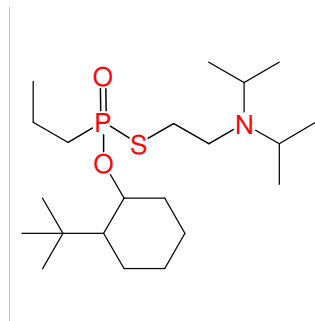

**Chemical name:** 2-Methylbutyl S-2-dipropylaminoethyl isopropylphosphonothiolate

Schedule: 1A03

CAS RN: HS code: 2930.90

Key: (137-32-6)-I1A3-PP

Molecular formula: C<sub>16</sub>H<sub>36</sub>NO<sub>2</sub>PS

CAS Index Name:

**IUPAC name:**

Synonyms:

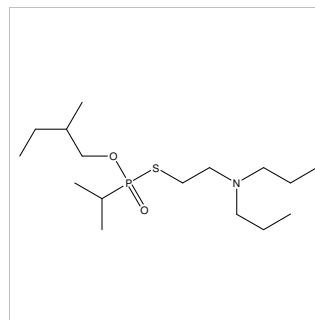

**Chemical name:** Nonyl S-2-dipropylaminoethyl isopropylphosphonothiolate

Schedule: 1A03

CAS RN: HS code: 2930.90

Key: (143-08-8)-I1A3-PP

Molecular formula: C<sub>20</sub>H<sub>44</sub>NO<sub>2</sub>PS

CAS Index Name:

**IUPAC name:**

Synonyms:

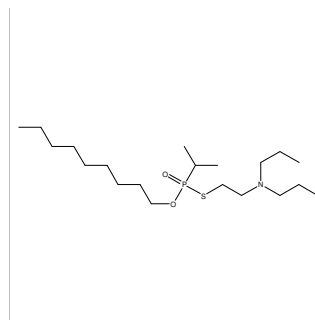

**Chemical name:** 3-Methylcyclopentyl S-2-dimethylaminoethyl ethylphosphonothiolate

Schedule: 1A03

CAS RN: HS code: 2930.90

Key: (18729-48-1)-E1A3-MM

Molecular formula: C<sub>12</sub>H<sub>26</sub>NO<sub>2</sub>PS

CAS Index Name:

**IUPAC name:**

Synonyms:

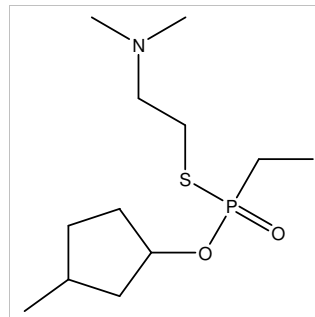



**Chemical name:** 3-Methylcyclopentyl S-2-diethylaminoethyl isopropylphosphonothiolate

Schedule: 1A03

CAS RN: HS code: 2930.90

Key: (18729-48-1)-I1A3-EE

Molecular formula: C<sub>15</sub>H<sub>32</sub>NO<sub>2</sub>PS

CAS Index Name:

**IUPAC name:**

Synonyms:

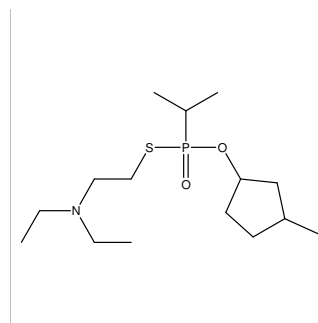

**Chemical name:** 3-Methylcyclopentyl S-2-dimethylaminoethyl isopropylphosphonothiolate

Schedule: 1A03

CAS RN: HS code: 2930.90

Key: (18729-48-1)-I1A3-MM

Molecular formula: C<sub>13</sub>H<sub>28</sub>NO<sub>2</sub>PS

CAS Index Name:

**IUPAC name:**

Synonyms:

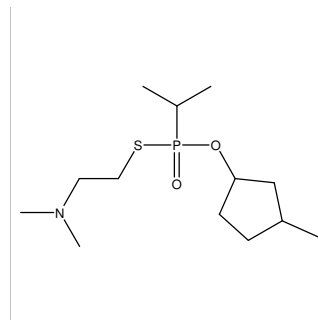

**Chemical name:** 3-Methylcyclopentyl S-2-dipropylaminoethyl isopropylphosphonothiolate

Schedule: 1A03

CAS RN: HS code: 2930.90

Key: (18729-48-1)-I1A3-PP

Molecular formula: C<sub>17</sub>H<sub>36</sub>NO<sub>2</sub>PS

CAS Index Name:

**IUPAC name:**

Synonyms:

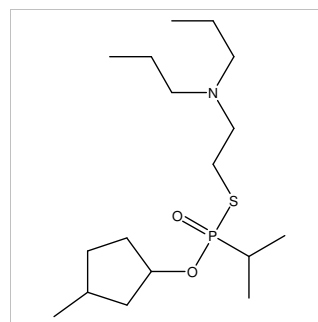

**Chemical name:** 3-Methylcyclopentyl S-2-diethylaminoethyl methylphosphonothiolate

Schedule: 1A03

CAS RN: HS code: 2930.90

Key: (18729-48-1)-M1A3-EE

Molecular formula: C<sub>13</sub>H<sub>28</sub>NO<sub>2</sub>PS

CAS Index Name:

**IUPAC name:**

Synonyms:

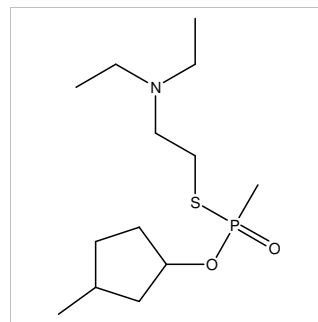

**Chemical name:** 3-Methylcyclopentyl S-2-diisopropylaminoethyl methylphosphonothiolate

Schedule: 1A03

CAS RN: HS code: 2930.90

Key: (18729-48-1)-M1A3-II

Molecular formula: C<sub>15</sub>H<sub>32</sub>NO<sub>2</sub>PS

CAS Index Name:

**IUPAC name:**

Synonyms:

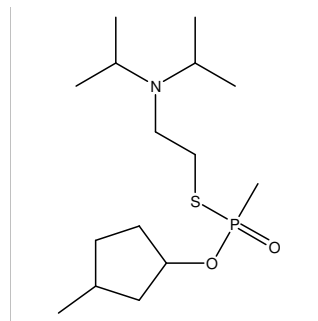

**Chemical name:** 3-Methylcyclopentyl S-2-dipropylaminoethyl methylphosphonothiolate

Schedule: 1A03

CAS RN: HS code: 2930.90

Key: (18729-48-1)-M1A3-PP

Molecular formula: C<sub>15</sub>H<sub>32</sub>NO<sub>2</sub>PS

CAS Index Name:

**IUPAC name:**

Synonyms:

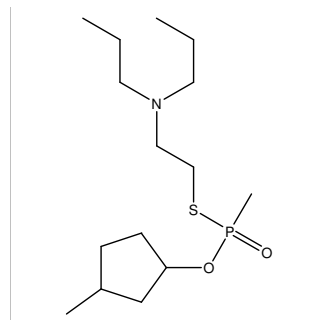

**Chemical name:** 3-Methylcyclopentyl S-2-diethylaminoethyl propylphosphonothiolate

Schedule: 1A03

CAS RN: HS code: 2930.90

Key: (18729-48-1)-P1A3-EE

Molecular formula: C<sub>15</sub>H<sub>32</sub>NO<sub>2</sub>PS

CAS Index Name:

**IUPAC name:**

Synonyms:

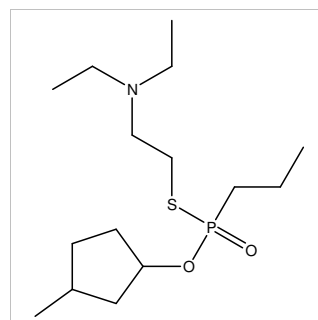

**Chemical name:** 3-Methylcyclopentyl S-2-dimethylaminoethyl propylphosphonothiolate

Schedule: 1A03

CAS RN: HS code: 2930.90

Key: (18729-48-1)-P1A3-MM

Molecular formula: C<sub>13</sub>H<sub>28</sub>NO<sub>2</sub>PS

CAS Index Name:

**IUPAC name:**

Synonyms:

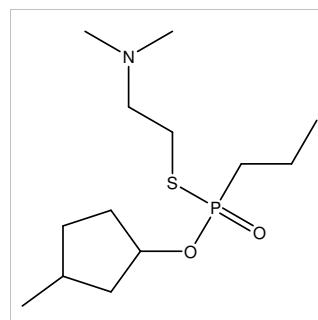

**Chemical name:** 1-Ethylhexyl S-2-diisopropylaminoethyl ethylphosphonothiolate

Schedule: 1A03

CAS RN:

HS code: 2930.90

Key: (20296-29-1)-E1A3-II

Molecular formula: C<sub>18</sub>H<sub>40</sub>NO<sub>2</sub>PS

CAS Index Name:

**IUPAC name:**

Synonyms:

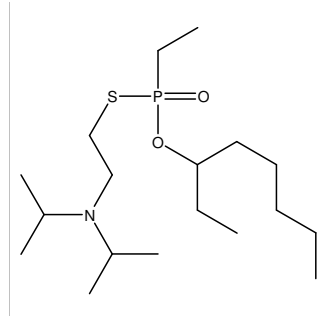

**Chemical name:** 1-Ethylhexyl S-2-diethylaminoethyl isopropylphosphonothiolate

Schedule: 1A03

CAS RN:

HS code: 2930.90

Key: (20296-29-1)-I1A3-EE

Molecular formula: C<sub>17</sub>H<sub>38</sub>NO<sub>2</sub>PS

CAS Index Name:

**IUPAC name:**

Synonyms:

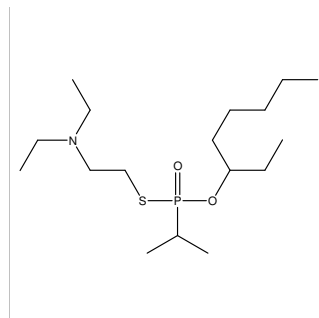

**Chemical name:** 1-Ethylhexyl S-2-dipropylaminoethyl isopropylphosphonothiolate

Schedule: 1A03

CAS RN:

HS code: 2930.90

Key: (20296-29-1)-I1A3-PP

Molecular formula: C<sub>19</sub>H<sub>42</sub>NO<sub>2</sub>PS

CAS Index Name:

**IUPAC name:**

Synonyms:

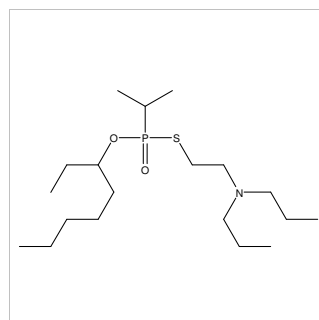

**Chemical name:** 1-Ethylhexyl S-2-diethylaminoethyl methylphosphonothiolate

Schedule: 1A03

CAS RN:

HS code: 2930.90

Key: (20296-29-1)-M1A3-EE

Molecular formula: C<sub>15</sub>H<sub>34</sub>NO<sub>2</sub>PS

CAS Index Name:

**IUPAC name:**

Synonyms:

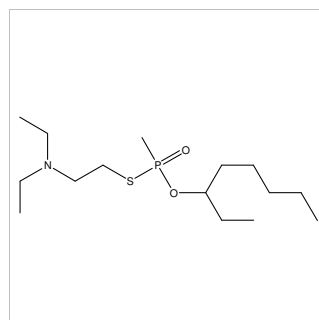

**Chemical name:** 1-Ethylhexyl S-2-diisopropylaminoethyl methylphosphonothiolate

Schedule: 1A03

CAS RN: HS code: 2930.90

Key: (20296-29-1)-M1A3-II

Molecular formula: C<sub>17</sub>H<sub>38</sub>NO<sub>2</sub>PS

CAS Index Name:

**IUPAC name:**

Synonyms:

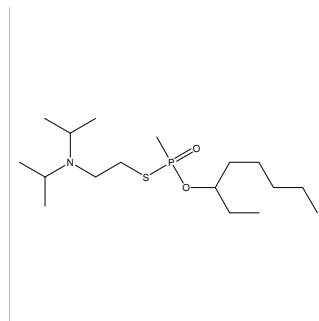

**Chemical name:** 1-Ethylhexyl S-2-diethylaminoethyl propylphosphonothiolate

Schedule: 1A03

CAS RN: HS code: 2930.90

Key: (20296-29-1)-P1A3-EE

Molecular formula: C<sub>17</sub>H<sub>38</sub>NO<sub>2</sub>PS

CAS Index Name:

**IUPAC name:**

Synonyms:

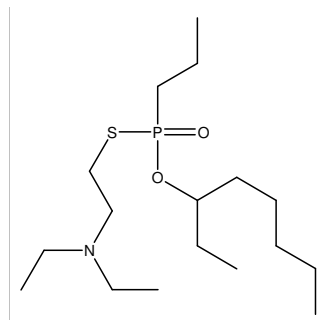

**Chemical name:** Cyclopentylmethyl S-2-diethylaminoethyl methylphosphonothiolate

Schedule: 1A03

CAS RN: HS code: 2930.90

Key: (3637-61-4)-M1A3-EE

Molecular formula: C<sub>13</sub>H<sub>28</sub>NO<sub>2</sub>PS

CAS Index Name:

**IUPAC name:**

Synonyms:

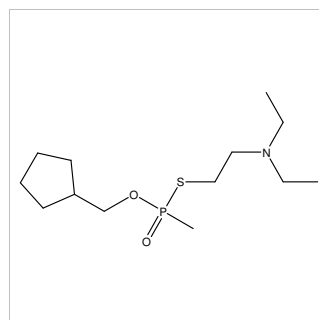

**Chemical name:** 2-Ethylcyclohexyl S-2-diethylaminoethyl methylphosphonothiolate

Schedule: 1A03

CAS RN: HS code: 2930.90

Key: (3760-20-1)-M1A3-EE

Molecular formula: C<sub>15</sub>H<sub>32</sub>NO<sub>2</sub>PS

CAS Index Name:

**IUPAC name:**

Synonyms:

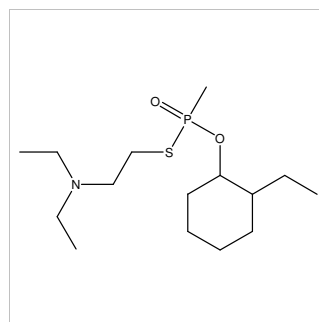

**Chemical name:** 2-Cyclohexylethyl S-2-diethylaminoethyl methylphosphonothiolate

Schedule: 1A03

CAS RN: HS code: 2930.90

Key: (4442-79-9)-M1A3-EE

Molecular formula: C<sub>15</sub>H<sub>32</sub>NO<sub>2</sub>PS

CAS Index Name:

**IUPAC name:**

Synonyms:

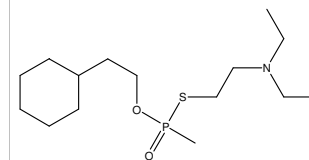

**Chemical name:** Pinacolyl S-2-diethylaminoethyl ethylphosphonothiolate

Schedule: 1A03

CAS RN: HS code: 2930.90

Key: (464-07-3)-E1A3-EE

Molecular formula: C<sub>14</sub>H<sub>32</sub>NO<sub>2</sub>PS

CAS Index Name: Phosphonothioic acid, ethyl-, S-[2-(diethylamino)ethyl] O-(1,2,2-trimethylpropyl) ester

**IUPAC name:** 1,2,2-Trimethylpropyl S-2-diethylaminoethyl ethylphosphonothioate

Synonyms: Phosphonothioic acid, ethyl-, S-[2-(diethylamino)ethyl] O-3,3-dimethylbut-2-yl ester

O-Pinacolyl S-2-diethylaminoethyl ethylphosphonothiolate

3,3-Dimethylbutan-2-yl S-[2-(diethylamino)ethyl] ethylphosphonothiolate

3,3-Dimethylbut-2-yl S-[2-(diethylamino)ethyl] ethylphosphonothiolate

1,2,2-Trimethylpropyl S-[2-(diethylamino)ethyl] ethylphosphonothiolate

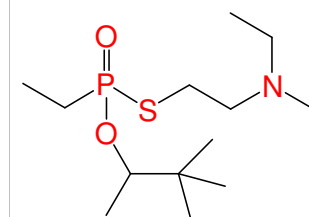

**Chemical name:** Pinacolyl S-2-N-ethyl-N-isopropylaminoethyl ethylphosphonothiolate

Schedule: 1A03

CAS RN: HS code: 2930.90

Key: (464-07-3)-E1A3-EI

Molecular formula: C<sub>15</sub>H<sub>34</sub>NO<sub>2</sub>PS

CAS Index Name:

**IUPAC name:**

Synonyms:

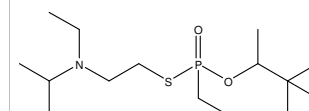

**Chemical name:** Pinacolyl S-2-N-ethyl-N-methylaminoethyl ethylphosphonothiolate

Schedule: 1A03

CAS RN: HS code: 2930.90

Key: (464-07-3)-E1A3-EM

Molecular formula: C<sub>13</sub>H<sub>30</sub>NO<sub>2</sub>PS

CAS Index Name:

**IUPAC name:**

Synonyms:

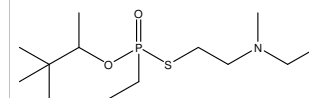

**Chemical name:** Pinacolyl S-2-N-ethyl-N-propylaminoethyl ethylphosphonothiolate

Schedule: 1A03

CAS RN: HS code: 2930.90

Key: (464-07-3)-E1A3-EP

Molecular formula: C<sub>15</sub>H<sub>34</sub>NO<sub>2</sub>PS

CAS Index Name:

**IUPAC name:**

Synonyms:

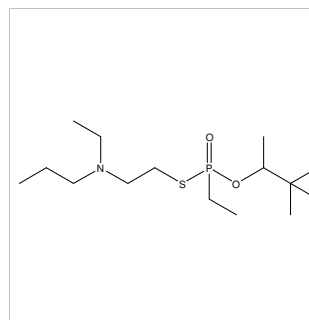

**Chemical name:** Pinacolyl S-2-diisopropylaminoethyl ethylphosphonothiolate

Schedule: 1A03

CAS RN: HS code: 2930.90

Key: (464-07-3)-E1A3-II

Molecular formula: C<sub>16</sub>H<sub>36</sub>NO<sub>2</sub>PS

CAS Index Name: Phosphonothioic acid, ethyl-, S-[2-(bis(1-methylethyl)amino)ethyl] O-(1,2,2-trimethylpropyl) ester

**IUPAC name:** 1,2,2-Trimethylpropyl S-2-diisopropylaminoethyl ethylphosphonothioate

Synonyms: Phosphonothioic acid, ethyl-, S-[2-(bis(1-methylethyl)amino)ethyl] O-3,3-dimethylbut-  
Phosphonothioic acid, ethyl-, S-[2-(bis(1-methylethyl)amino)ethyl] O-(1,2,2-trimethylpropyl) ester

O-Pinacolyl S-2-diisopropylaminoethyl ethylphosphonothiolate

3,3-Dimethylbutan-2-yl S-2-diisopropylaminoethyl ethylphosphonothiolate

3,3-Dimethylbut-2-yl S-[2-(diisopropylamino)ethyl] ethylphosphonothiolate

1,2,2-Trimethylpropyl S-[2-(diisopropylamino)ethyl] ethylphosphonothiolate

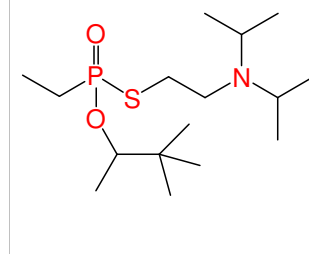

**Chemical name:** Pinacolyl S-2-N-isopropyl-N-methylaminoethyl ethylphosphonothiolate

Schedule: 1A03

CAS RN: HS code: 2930.90

Key: (464-07-3)-E1A3-IM

Molecular formula: C<sub>14</sub>H<sub>32</sub>NO<sub>2</sub>PS

CAS Index Name:

**IUPAC name:**

Synonyms:

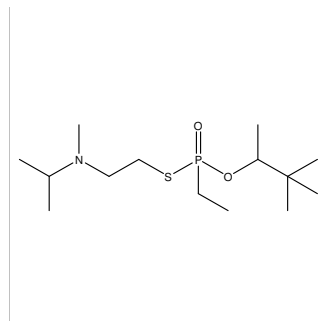

**Chemical name:** Pinacolyl S-2-N-isopropyl-N-propylaminoethyl ethylphosphonothiolate

Schedule: 1A03

CAS RN: HS code: 2930.90

Key: (464-07-3)-E1A3-IP

Molecular formula: C<sub>16</sub>H<sub>36</sub>NO<sub>2</sub>PS

CAS Index Name:

**IUPAC name:**

Synonyms:

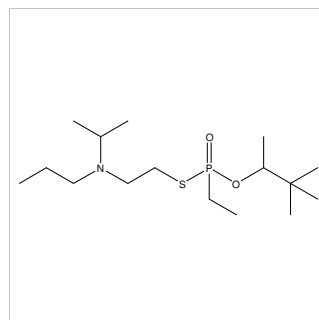

**Chemical name:** Pinacolyl S-2-dimethylaminoethyl ethylphosphonothiolate

Schedule: 1A03

CAS RN: HS code: 2930.90

Key: (464-07-3)-E1A3-MM

Molecular formula: C<sub>12</sub>H<sub>28</sub>NO<sub>2</sub>PS

CAS Index Name: Phosphonothioic acid, ethyl-, S-[2-(dimethylamino)ethyl] O-(1,2,2-trimethylpropyl) ester

**IUPAC name:** 1,2,2-Trimethylpropyl S-2-dimethylaminoethyl ethylphosphonothioate

Synonyms: Phosphonothioic acid, ethyl-, S-[2-(dimethylamino)ethyl] O-3,3-dimethylbut-2-yl ester

O-Pinacolyl S-2-dimethylaminoethyl ethylphosphonothiolate

O-3,3-Dimethylbut-2-yl S-[2-(dimethylamino)ethyl] ethylphosphonothiolate

O-1,2,2-Trimethylpropyl S-[2-(dimethylamino)ethyl] ethylphosphonothiolate

3,3-Dimethylbutan-2-yl S-2-dimethylaminoethyl ethylphosphonothiolate

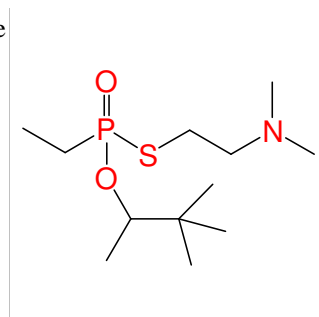

**Chemical name:** Pinacolyl S-2-N-methyl-N-propylaminoethyl ethylphosphonothiolate

Schedule: 1A03

CAS RN: HS code: 2930.90

Key: (464-07-3)-E1A3-MP

Molecular formula: C<sub>14</sub>H<sub>32</sub>NO<sub>2</sub>PS

CAS Index Name:

**IUPAC name:**

Synonyms:

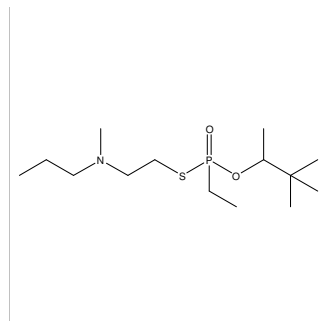

**Chemical name:** Pinacolyl S-2-dipropylaminoethyl ethylphosphonothiolate

Schedule: 1A03

CAS RN: HS code: 2930.90

Key: (464-07-3)-E1A3-PP

Molecular formula: C<sub>16</sub>H<sub>36</sub>NO<sub>2</sub>PS

CAS Index Name: Phosphonothioic acid, ethyl-, S-[2-(dipropylamino)ethyl] O-(1,2,2-trimethylpropyl) ester

**IUPAC name:** 1,2,2-Trimethylpropyl S-2-dipropylaminoethyl ethylphosphonothioate

Synonyms: Phosphonothioic acid, ethyl-, S-[2-(dipropylamino)ethyl] O-3,3-dimethylbut-2-yl ester

O-Pinacolyl S-2-dipropylaminoethyl ethylphosphonothiolate

O-3,3-Dimethylbut-2-yl S-[2-(dipropylamino)ethyl] ethylphosphonothiolate

O-1,2,2-Trimethylpropyl S-[2-(dipropylamino)ethyl] ethylphosphonothiolate

3,3-Dimethylbutan-2-yl S-2-dipropylaminoethyl ethylphosphonothiolate

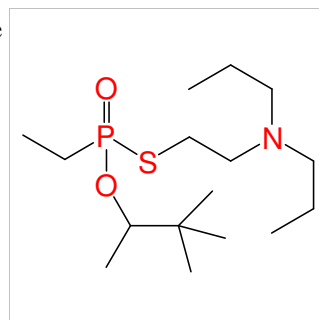

**Chemical name:** Pinacolyl S-2-diethylaminoethyl isopropylphosphonothiolate

Schedule: 1A03

CAS RN: HS code: 2930.90

Key: (464-07-3)-I1A3-EE

Molecular formula: C<sub>15</sub>H<sub>34</sub>NO<sub>2</sub>PS

CAS Index Name:

**IUPAC name:**

Synonyms: 1,2,2-Trimethylpropyl S-2-diethylaminoethyl isopropylphosphonothiolate

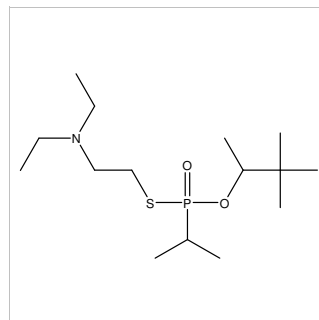



**Chemical name:** Pinacolyl S-2-N-ethyl-N-isopropylaminoethyl isopropylphosphonothiolate

Schedule: 1A03

CAS RN: HS code: 2930.90

Key: (464-07-3)-I1A3-EI

Molecular formula: C<sub>16</sub>H<sub>36</sub>NO<sub>2</sub>PS

CAS Index Name:

**IUPAC name:**

Synonyms:

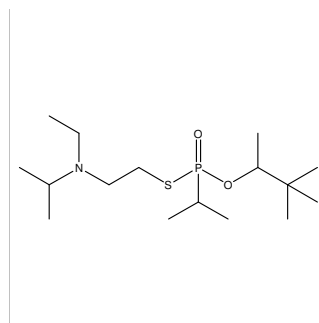

**Chemical name:** Pinacolyl S-2-N-ethyl-N-methylaminoethyl isopropylphosphonothiolate

Schedule: 1A03

CAS RN: HS code: 2930.90

Key: (464-07-3)-I1A3-EM

Molecular formula: C<sub>14</sub>H<sub>32</sub>NO<sub>2</sub>PS

CAS Index Name:

**IUPAC name:**

Synonyms:

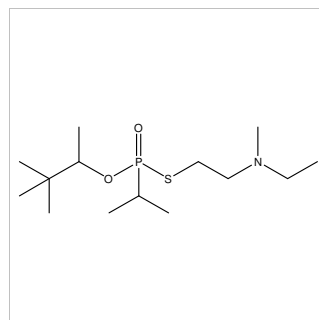

**Chemical name:** Pinacolyl S-2-N-ethyl-N-propylaminoethyl isopropylphosphonothiolate

Schedule: 1A03

CAS RN: HS code: 2930.90

Key: (464-07-3)-I1A3-EP

Molecular formula: C<sub>16</sub>H<sub>36</sub>NO<sub>2</sub>PS

CAS Index Name:

**IUPAC name:**

Synonyms:

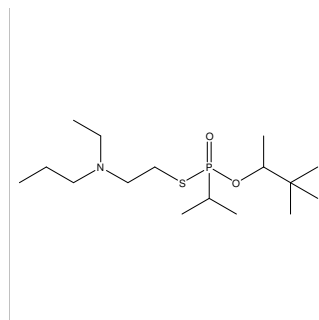

**Chemical name:** Pinacolyl S-2-diisopropylaminoethyl isopropylphosphonothiolate

Schedule: 1A03

CAS RN: HS code: 2930.90

Key: (464-07-3)-I1A3-II

Molecular formula: C<sub>17</sub>H<sub>38</sub>NO<sub>2</sub>PS

CAS Index Name:

**IUPAC name:**

Synonyms:

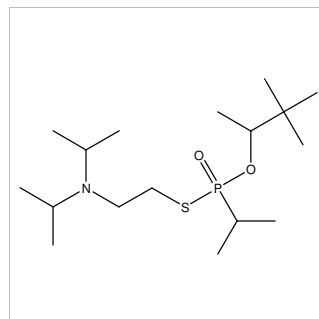

**Chemical name:** Pinacolyl S-2-N-isopropyl-N-methylaminoethyl isopropylphosphonothiolate

Schedule: 1A03

CAS RN: HS code: 2930.90

Key: (464-07-3)-I1A3-IM

Molecular formula: C<sub>15</sub>H<sub>34</sub>NO<sub>2</sub>PS

CAS Index Name:

**IUPAC name:**

Synonyms:

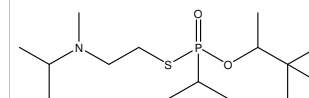

**Chemical name:** Pinacolyl S-2-N-isopropyl-N-propylaminoethyl isopropylphosphonothiolate

Schedule: 1A03

CAS RN: HS code: 2930.90

Key: (464-07-3)-I1A3-IP

Molecular formula: C<sub>17</sub>H<sub>38</sub>NO<sub>2</sub>PS

CAS Index Name:

**IUPAC name:**

Synonyms:

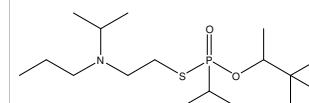

**Chemical name:** Pinacolyl S-2-N-methyl-N-propylaminoethyl isopropylphosphonothiolate

Schedule: 1A03

CAS RN: HS code: 2930.90

Key: (464-07-3)-I1A3-MP

Molecular formula: C<sub>15</sub>H<sub>34</sub>NO<sub>2</sub>PS

CAS Index Name:

**IUPAC name:**

Synonyms:

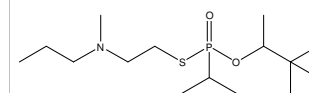

**Chemical name:** Pinacolyl S-2-dipropylaminoethyl isopropylphosphonothiolate

Schedule: 1A03

CAS RN: HS code: 2930.90

Key: (464-07-3)-I1A3-PP

Molecular formula: C<sub>17</sub>H<sub>38</sub>NO<sub>2</sub>PS

CAS Index Name:

**IUPAC name:**

Synonyms: 1,2,2-Trimethylpropyl S-2-dipropylaminoethyl isopropylphosphonothiolate

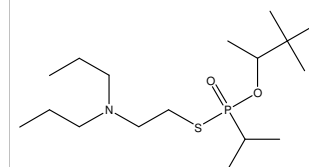

**Chemical name:** Pinacolyl S-2-N-ethyl-N-isopropylaminoethyl methylphosphonothiolate

Schedule: 1A03

CAS RN: HS code: 2930.90

Key: (464-07-3)-M1A3-EI

Molecular formula: C<sub>14</sub>H<sub>32</sub>NO<sub>2</sub>PS

CAS Index Name:

**IUPAC name:**

Synonyms:

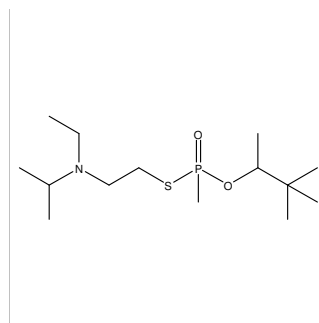

**Chemical name:** Pinacolyl S-2-N-ethyl-N-methylaminoethyl methylphosphonothiolate

Schedule: 1A03

CAS RN: HS code: 2930.90

Key: (464-07-3)-M1A3-EM

Molecular formula: C<sub>12</sub>H<sub>28</sub>NO<sub>2</sub>PS

CAS Index Name:

**IUPAC name:**

Synonyms:

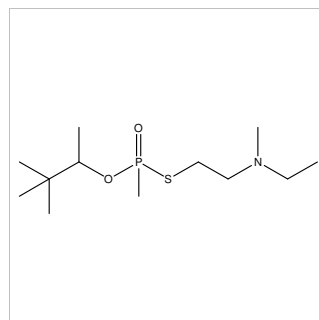

**Chemical name:** Pinacolyl S-2-N-ethyl-N-propylaminoethyl methylphosphonothiolate

Schedule: 1A03

CAS RN: HS code: 2930.90

Key: (464-07-3)-M1A3-EP

Molecular formula: C<sub>14</sub>H<sub>32</sub>NO<sub>2</sub>PS

CAS Index Name:

**IUPAC name:**

Synonyms:

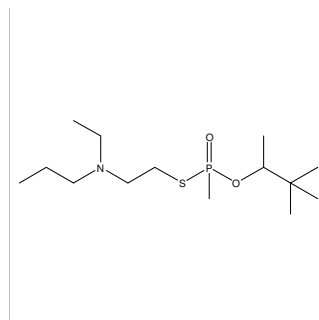

**Chemical name:** Pinacolyl S-2-N-isopropyl-N-methylaminoethyl methylphosphonothiolate

Schedule: 1A03

CAS RN: HS code: 2930.90

Key: (464-07-3)-M1A3-IM

Molecular formula: C<sub>13</sub>H<sub>30</sub>NO<sub>2</sub>PS

CAS Index Name:

**IUPAC name:**

Synonyms:

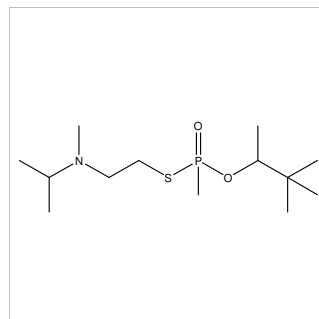

**Chemical name:** Pinacolyl S-2-N-isopropyl-N-propylaminoethyl methylphosphonothiolate

Schedule: 1A03

CAS RN: HS code: 2930.90

Key: (464-07-3)-M1A3-IP

Molecular formula: C<sub>15</sub>H<sub>34</sub>NO<sub>2</sub>PS

CAS Index Name:

**IUPAC name:**

Synonyms:

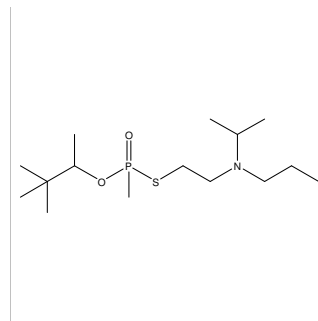

**Chemical name:** Pinacolyl S-2-N-methyl-N-propylaminoethyl methylphosphonothiolate

Schedule: 1A03

CAS RN: HS code: 2930.90

Key: (464-07-3)-M1A3-MP

Molecular formula: C<sub>13</sub>H<sub>30</sub>NO<sub>2</sub>PS

CAS Index Name:

**IUPAC name:**

Synonyms:

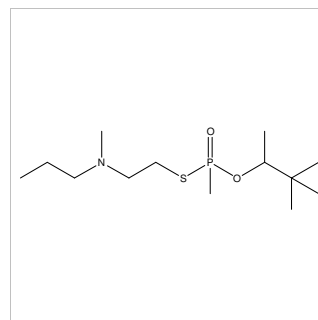

**Chemical name:** Pinacolyl S-2-dipropylaminoethyl methylphosphonothiolate

Schedule: 1A03

CAS RN: HS code: 2930.90

Key: (464-07-3)-M1A3-PP

Molecular formula: C<sub>15</sub>H<sub>34</sub>NO<sub>2</sub>PS

CAS Index Name: Phosphonothioic acid, methyl-, S-[2-(dipropylamino)ethyl] O-(1,2,2-trimethylpropyl) ester

**IUPAC name:** 1,2,2-Trimethylpropyl S-2-dipropylaminoethyl methylphosphonothioate

Synonyms: Phosphonothioic acid, methyl-, S-[2-(dipropylamino)ethyl] O-3,3-dimethylbut-2-yl ester  
 O-Pinacolyl S-2-dipropylaminoethyl methylphosphonothiolate  
 O-3,3-Dimethylbut-2-yl S-[2-(dipropylamino)ethyl] methylphosphonothiolate  
 O-1,2,2-Trimethylpropyl S-[2-(dipropylamino)ethyl] methylphosphonothiolate  
 3,3-Dimethylbutan-2-yl S-2-dipropylaminoethyl methylphosphonothiolate  
 3,3-Dimethylbut-2-yl S-2-dipropylaminoethyl methylphosphonothiolate

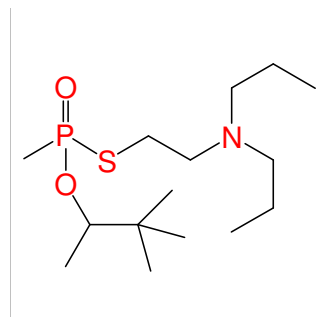

**Chemical name:** Pinacolyl S-2-N-isopropyl-N-ethylaminoethyl propylphosphonothiolate

Schedule: 1A03

CAS RN: HS code: 2930.90

Key: (464-07-3)-P1A3-EI

Molecular formula: C<sub>16</sub>H<sub>36</sub>NO<sub>2</sub>PS

CAS Index Name:

**IUPAC name:**

Synonyms:

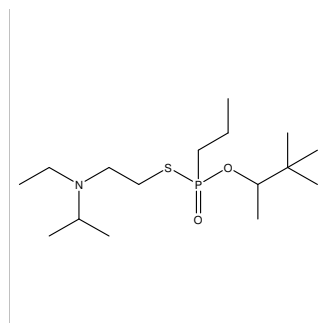

**Chemical name:** Pinacolyl S-2-N-ethyl-N-methylaminoethyl propylphosphonothiolate

Schedule: 1A03

CAS RN: HS code: 2930.90

Key: (464-07-3)-P1A3-EM

Molecular formula: C<sub>14</sub>H<sub>32</sub>NO<sub>2</sub>PS

CAS Index Name:

**IUPAC name:**

Synonyms:

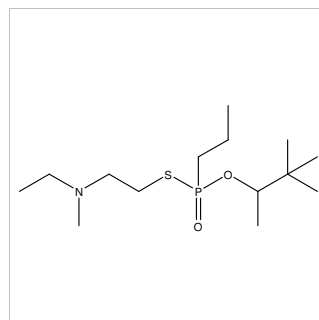

**Chemical name:** Pinacolyl S-2-N-ethyl-N-propylaminoethyl propylphosphonothiolate

Schedule: 1A03

CAS RN: HS code: 2930.90

Key: (464-07-3)-P1A3-EP

Molecular formula: C<sub>16</sub>H<sub>36</sub>NO<sub>2</sub>PS

CAS Index Name:

**IUPAC name:**

Synonyms:

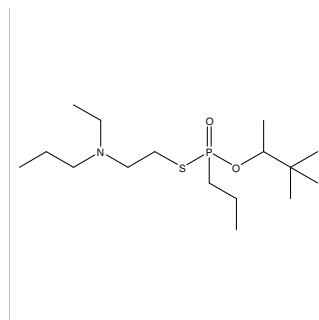

**Chemical name:** Pinacolyl S-2-N-isopropyl-N-methylaminoethyl propylphosphonothiolate

Schedule: 1A03

CAS RN: HS code: 2930.90

Key: (464-07-3)-P1A3-IM

Molecular formula: C<sub>15</sub>H<sub>34</sub>NO<sub>2</sub>PS

CAS Index Name:

**IUPAC name:**

Synonyms:

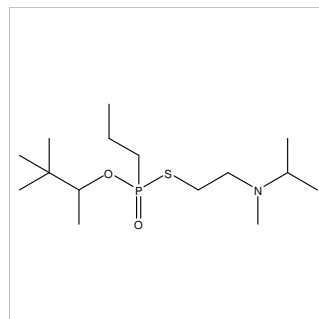

**Chemical name:** Pinacolyl S-2-N-isopropyl-N-propylaminoethyl propylphosphonothiolate

Schedule: 1A03

CAS RN: HS code: 2930.90

Key: (464-07-3)-P1A3-IP

Molecular formula: C<sub>17</sub>H<sub>38</sub>NO<sub>2</sub>PS

CAS Index Name:

**IUPAC name:**

Synonyms:

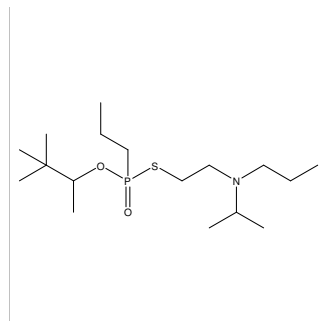

**Chemical name:** Pinacolyl S-2-N-methyl-N-propylaminoethyl propylphosphonothiolate

Schedule: 1A03

CAS RN: HS code: 2930.90

Key: (464-07-3)-P1A3-MP

Molecular formula: C<sub>15</sub>H<sub>34</sub>NO<sub>2</sub>PS

CAS Index Name:

**IUPAC name:**

Synonyms:

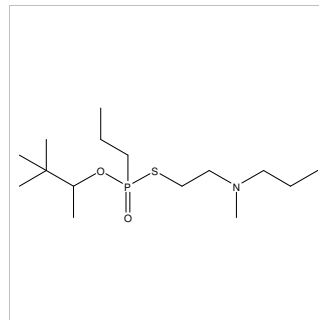

**Chemical name:** Pinacolyl S-2-dipropylaminoethyl propylphosphonothiolate

Schedule: 1A03

CAS RN: HS code: 2930.90

Key: (464-07-3)-P1A3-PP

Molecular formula: C<sub>17</sub>H<sub>38</sub>NO<sub>2</sub>PS

CAS Index Name:

**IUPAC name:**

Synonyms:

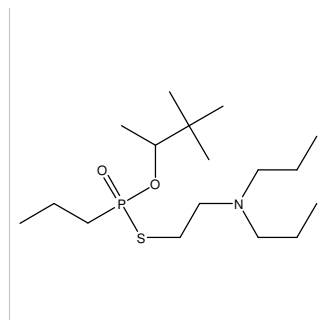

**Chemical name:** Cycloheptyl S-2-dimethylaminoethyl ethylphosphonothiolate

Schedule: 1A03

CAS RN: HS code: 2930.90

Key: (502-41-0)-E1A3-MM

Molecular formula: C<sub>13</sub>H<sub>28</sub>NO<sub>2</sub>PS

CAS Index Name:

**IUPAC name:**

Synonyms:

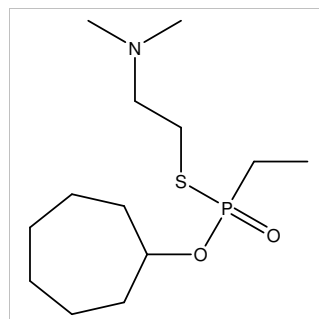

**Chemical name:** Cycloheptyl S-2-dimethylaminoethyl isopropylphosphonothiolate

Schedule: 1A03

CAS RN: HS code: 2930.90

Key: (502-41-0)-I1A3-MM

Molecular formula: C<sub>14</sub>H<sub>30</sub>NO<sub>2</sub>PS

CAS Index Name:

**IUPAC name:**

Synonyms:

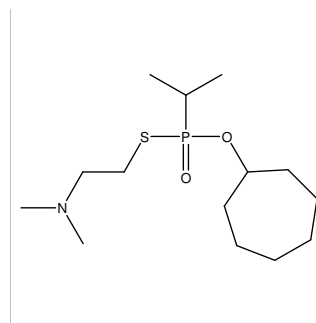

**Chemical name:** Cycloheptyl S-2-diethylaminoethyl methylphosphonothiolate

Schedule: 1A03

CAS RN: HS code: 2930.90

Key: (502-41-0)-M1A3-EE

Molecular formula: C<sub>14</sub>H<sub>30</sub>NO<sub>2</sub>PS

CAS Index Name:

**IUPAC name:**

Synonyms:

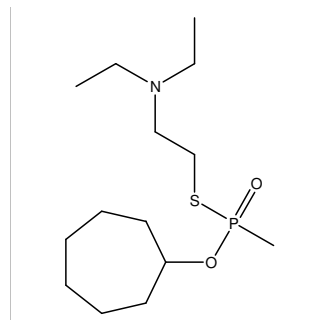

**Chemical name:** Cycloheptyl S-2-dipropylaminoethyl methylphosphonothiolate

Schedule: 1A03

CAS RN: HS code: 2930.90

Key: (502-41-0)-M1A3-PP

Molecular formula: C<sub>16</sub>H<sub>34</sub>NO<sub>2</sub>PS

CAS Index Name:

**IUPAC name:**

Synonyms:

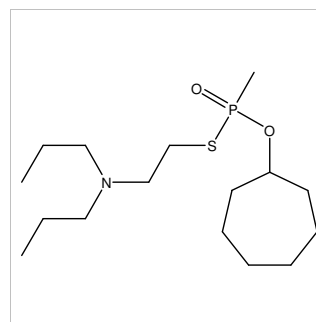

**Chemical name:** Cycloheptyl S-2-dimethylaminoethyl propylphosphonothiolate

Schedule: 1A03

CAS RN: HS code: 2930.90

Key: (502-41-0)-P1A3-MM

Molecular formula: C<sub>14</sub>H<sub>30</sub>NO<sub>2</sub>PS

CAS Index Name:

**IUPAC name:**

Synonyms:

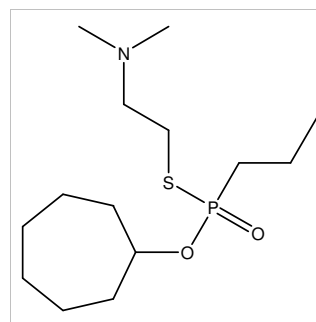

**Chemical name:** 2,6-Dimethylcyclohexyl S-2-diisopropylaminoethyl isopropylphosphonothiolate

Schedule: 1A03

CAS RN: HS code: 2930.90

Key: (5337-72-4)-I1A3-II

Molecular formula: C<sub>19</sub>H<sub>40</sub>NO<sub>2</sub>PS

CAS Index Name: Phosphonothioic acid, 1-methylethyl-, S-[2-(bis(1-methylethyl)amino)ethyl] O-(2,6-dimethylcyclohexyl) ester

**IUPAC name:** 2,6-Dimethylcyclohexyl S-2-diisopropylaminoethyl isopropylphosphonothioate

Synonyms: Phosphonothioic acid, 1-methylethyl-, S-[2-(bis(1-methylethyl)amino)ethyl] O-2,6-dimethylcyclohexyl ester

O-2,6-Dimethylcyclohexyl S-2-diisopropylaminoethyl isopropylphosphonothiolate

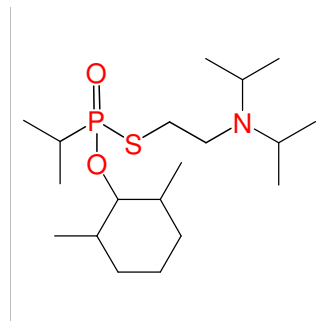

**Chemical name:** 1-Methylhexyl S-2-diethylaminoethyl methylphosphonothiolate

Schedule: 1A03

CAS RN: HS code: 2930.90

Key: (543-49-7)-M1A3-EE

Molecular formula: C<sub>14</sub>H<sub>32</sub>NO<sub>2</sub>PS

CAS Index Name:

**IUPAC name:**

Synonyms:

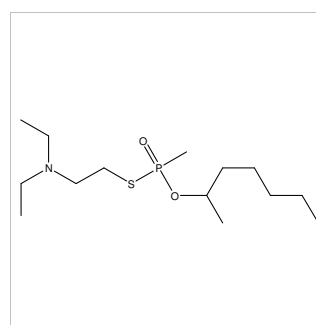

**Chemical name:** 1-Methylhexyl S-2-dipropylaminoethyl methylphosphonothiolate

Schedule: 1A03

CAS RN: HS code: 2930.90

Key: (543-49-7)-M1A3-PP

Molecular formula: C<sub>16</sub>H<sub>36</sub>NO<sub>2</sub>PS

CAS Index Name:

**IUPAC name:**

Synonyms:

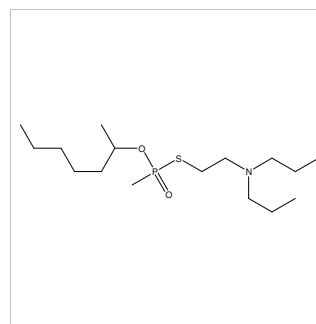



**Chemical name:** 3,5-Dimethylcyclohexyl S-2-diisopropylaminoethyl isopropylphosphonothiolate

Schedule: 1A03

CAS RN: HS code: 2930.90

Key: (5441-52-1)-I1A3-II

Molecular formula: C<sub>19</sub>H<sub>40</sub>NO<sub>2</sub>PS

CAS Index Name: Phosphonothioic acid, 1-methylethyl-, S-[2-(bis(1-methylethyl)amino)ethyl] O-(3,5-dimethylcyclohexyl) ester

**IUPAC name:** 3,5-Dimethylcyclohexyl S-2-diisopropylaminoethyl isopropylphosphonothioate

Synonyms: Phosphonothioic acid, 1-methylethyl-, S-[2-(bis(1-methylethyl)amino)ethyl] O-3,5-dimethylcyclohexyl ester

O-3,5-Dimethylcyclohexyl S-2-diisopropylaminoethyl isopropylphosphonothiolate

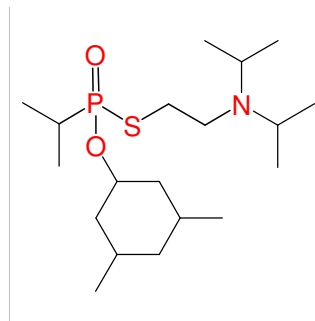

**Chemical name:** 1,2-Dimethylbutyl S-2-diethylaminoethyl isopropylphosphonothiolate

Schedule: 1A03

CAS RN: HS code: 2930.90

Key: (565-60-6)-I1A3-EE

Molecular formula: C<sub>15</sub>H<sub>34</sub>NO<sub>2</sub>PS

CAS Index Name:

**IUPAC name:**

Synonyms:

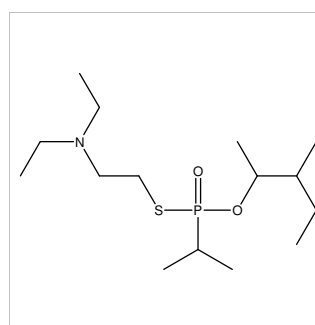

**Chemical name:** 1,2-Dimethylbutyl S-2-dipropylaminoethyl isopropylphosphonothiolate

Schedule: 1A03

CAS RN: HS code: 2930.90

Key: (565-60-6)-I1A3-PP

Molecular formula: C<sub>17</sub>H<sub>38</sub>NO<sub>2</sub>PS

CAS Index Name:

**IUPAC name:**

Synonyms:

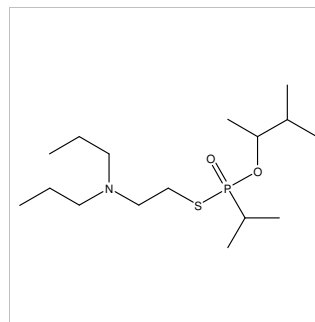

**Chemical name:** 1,2-Dimethylbutyl S-2-diethylaminoethyl propylphosphonothiolate

Schedule: 1A03

CAS RN: HS code: 2930.90

Key: (565-60-6)-P1A3-EE

Molecular formula: C<sub>15</sub>H<sub>34</sub>NO<sub>2</sub>PS

CAS Index Name:

**IUPAC name:**

Synonyms:

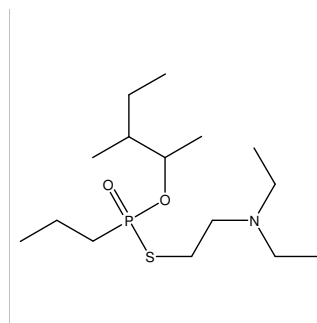

**Chemical name:** 1,2-Dimethylbutyl S-2-dipropylaminoethyl propylphosphonothiolate

Schedule: 1A03

CAS RN: HS code: 2930.90

Key: (565-60-6)-P1A3-PP

Molecular formula: C<sub>17</sub>H<sub>38</sub>NO<sub>2</sub>PS

CAS Index Name:

**IUPAC name:**

Synonyms:

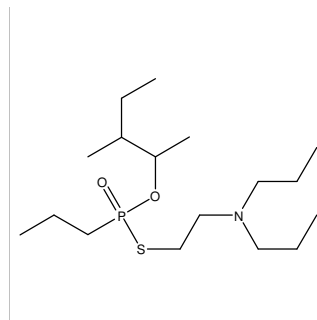

**Chemical name:** 2-Methylcyclohexyl S-2-diethylaminoethyl isopropylphosphonothiolate

Schedule: 1A03

CAS RN: HS code: 2930.90

Key: (583-59-5)-I1A3-EE

Molecular formula: C<sub>16</sub>H<sub>34</sub>NO<sub>2</sub>PS

CAS Index Name:

**IUPAC name:**

Synonyms:

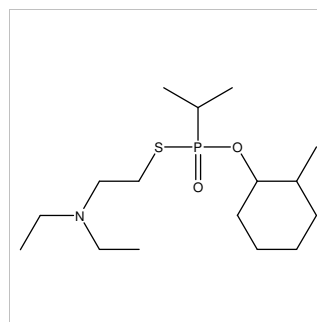

**Chemical name:** 2-Methylcyclohexyl S-2-diethylaminoethyl methylphosphonothiolate

Schedule: 1A03

CAS RN: HS code: 2930.90

Key: (583-59-5)-M1A3-EE

Molecular formula: C<sub>14</sub>H<sub>30</sub>NO<sub>2</sub>PS

CAS Index Name:

**IUPAC name:**

Synonyms:

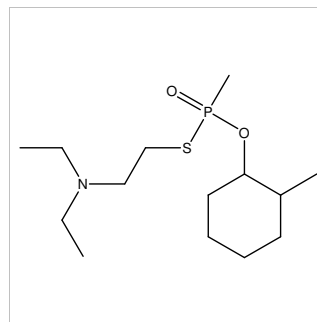

**Chemical name:** 2-Methylcyclohexyl S-2-dipropylaminoethyl methylphosphonothiolate

Schedule: 1A03

CAS RN: HS code: 2930.90

Key: (583-59-5)-M1A3-PP

Molecular formula: C<sub>16</sub>H<sub>34</sub>NO<sub>2</sub>PS

CAS Index Name:

**IUPAC name:**

Synonyms:

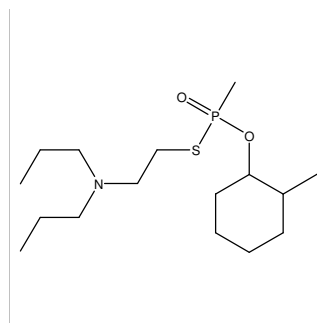

**Chemical name:** 2-Methylcyclohexyl S-2-diethylaminoethyl propylphosphonothiolate

Schedule: 1A03

CAS RN: HS code: 2930.90

Key: (583-59-5)-P1A3-EE

Molecular formula: C<sub>16</sub>H<sub>34</sub>NO<sub>2</sub>PS

CAS Index Name:

**IUPAC name:**

Synonyms:

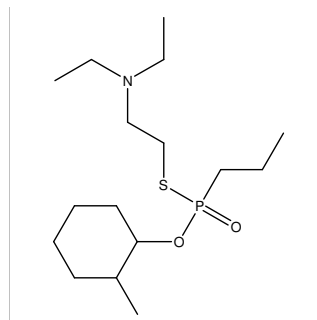

**Chemical name:** 1-Ethylpropyl S-2-dipropylaminoethyl isopropylphosphonothiolate

Schedule: 1A03

CAS RN: HS code: 2930.90

Key: (584-02-1)-I1A3-PP

Molecular formula: C<sub>16</sub>H<sub>36</sub>NO<sub>2</sub>PS

CAS Index Name:

**IUPAC name:**

Synonyms:

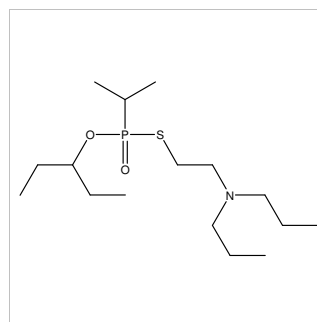

**Chemical name:** 1-Ethylpropyl S-2-dipropylaminoethyl propylphosphonothiolate

Schedule: 1A03

CAS RN: HS code: 2930.90

Key: (584-02-1)-P1A3-PP

Molecular formula: C<sub>16</sub>H<sub>36</sub>NO<sub>2</sub>PS

CAS Index Name:

**IUPAC name:**

Synonyms:

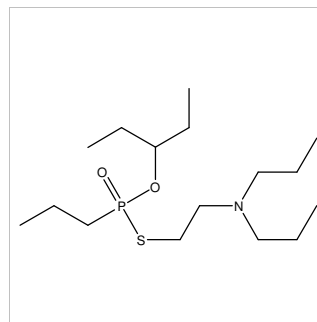

**Chemical name:** 3-Methylpentyl S-2-dipropylaminoethyl isopropylphosphonothiolate

Schedule: 1A03

CAS RN: HS code: 2930.90

Key: (589-35-5)-I1A3-PP

Molecular formula: C<sub>17</sub>H<sub>38</sub>NO<sub>2</sub>PS

CAS Index Name:

**IUPAC name:**

Synonyms:

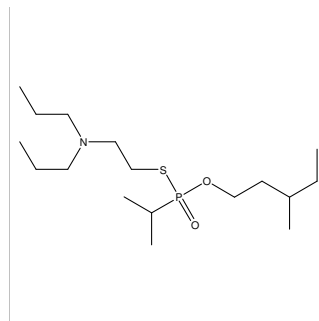

**Chemical name:** 3-Methylpentyl S-2-dipropylaminoethyl methylphosphonothiolate

Schedule: 1A03

CAS RN: HS code: 2930.90

Key: (589-35-5)-M1A3-PP

Molecular formula: C<sub>15</sub>H<sub>34</sub>NO<sub>2</sub>PS

CAS Index Name:

**IUPAC name:**

Synonyms:

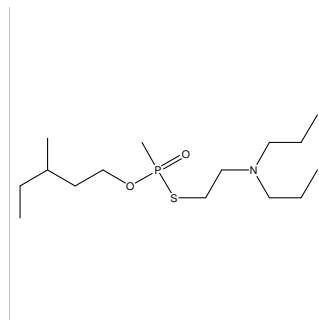

**Chemical name:** 3-Methylpentyl S-2-dipropylaminoethyl propylphosphonothiolate

Schedule: 1A03

CAS RN: HS code: 2930.90

Key: (589-35-5)-P1A3-PP

Molecular formula: C<sub>17</sub>H<sub>38</sub>NO<sub>2</sub>PS

CAS Index Name:

**IUPAC name:**

Synonyms:

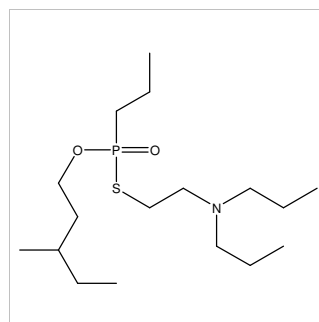

**Chemical name:** 1-Ethylpentyl S-2-dipropylaminoethyl isopropylphosphonothiolate

Schedule: 1A03

CAS RN: HS code: 2930.90

Key: (589-82-2)-I1A3-PP

Molecular formula: C<sub>18</sub>H<sub>40</sub>NO<sub>2</sub>PS

CAS Index Name:

**IUPAC name:**

Synonyms:

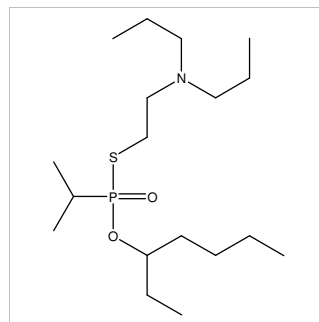

**Chemical name:** 1-Ethylpentyl S-2-dipropylaminoethyl methylphosphonothiolate

Schedule: 1A03

CAS RN: HS code: 2930.90

Key: (589-82-2)-M1A3-PP

Molecular formula: C<sub>16</sub>H<sub>36</sub>NO<sub>2</sub>PS

CAS Index Name:

**IUPAC name:**

Synonyms:

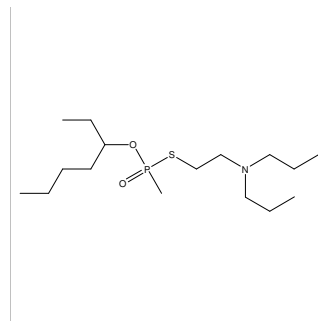

**Chemical name:** 4-Methylcyclohexyl S-2-dipropylaminoethyl isopropylphosphonothiolate

Schedule: 1A03

CAS RN: HS code: 2930.90

Key: (589-91-3)-I1A3-PP

Molecular formula: C<sub>18</sub>H<sub>38</sub>NO<sub>2</sub>PS

CAS Index Name:

**IUPAC name:**

Synonyms:

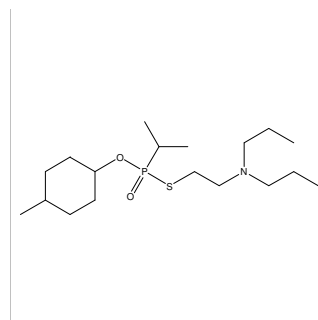

**Chemical name:** 4-Methylcyclohexyl S-2-diethylaminoethyl methylphosphonothiolate

Schedule: 1A03

CAS RN: HS code: 2930.90

Key: (589-91-3)-M1A3-EE

Molecular formula: C<sub>14</sub>H<sub>30</sub>NO<sub>2</sub>PS

CAS Index Name:

**IUPAC name:**

Synonyms:

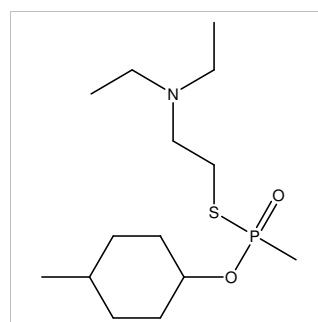

**Chemical name:** 4-Methylcyclohexyl S-2-diisopropylaminoethyl methylphosphonothiolate

Schedule: 1A03

CAS RN: HS code: 2930.90

Key: (589-91-3)-M1A3-II

Molecular formula: C<sub>16</sub>H<sub>34</sub>NO<sub>2</sub>PS

CAS Index Name:

**IUPAC name:**

Synonyms:

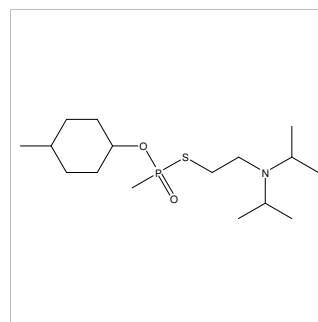

**Chemical name:** 4-Methylcyclohexyl S-2-dipropylaminoethyl methylphosphonothiolate

Schedule: 1A03

CAS RN: HS code: 2930.90

Key: (589-91-3)-M1A3-PP

Molecular formula: C<sub>16</sub>H<sub>34</sub>NO<sub>2</sub>PS

CAS Index Name:

**IUPAC name:**

Synonyms:

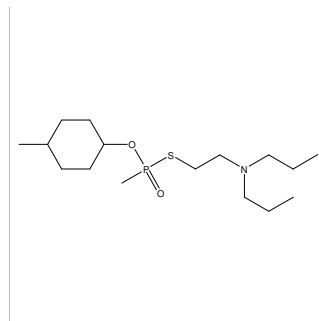

**Chemical name:** 3-Methylcyclohexyl S-2-diethylaminoethyl methylphosphonothiolate

Schedule: 1A03

CAS RN: HS code: 2930.90

Key: (591-23-1)-M1A3-EE

Molecular formula: C<sub>14</sub>H<sub>30</sub>NO<sub>2</sub>PS

CAS Index Name:

**IUPAC name:**

Synonyms:

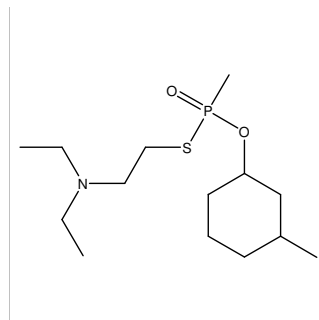

**Chemical name:** 3-Methylcyclohexyl S-2-dipropylaminoethyl methylphosphonothiolate

Schedule: 1A03

CAS RN: HS code: 2930.90

Key: (591-23-1)-M1A3-PP

Molecular formula: C<sub>16</sub>H<sub>34</sub>NO<sub>2</sub>PS

CAS Index Name:

**IUPAC name:**

Synonyms:

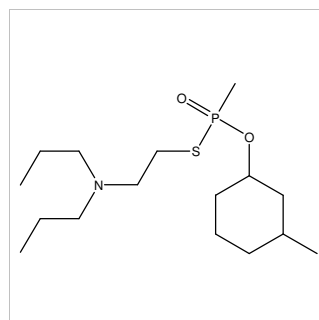

**Chemical name:** 1,2-Dimethylpropyl S-2-dipropylaminoethyl isopropylphosphonothiolate

Schedule: 1A03

CAS RN: HS code: 2930.90

Key: (598-75-4)-I1A3-PP

Molecular formula: C<sub>16</sub>H<sub>36</sub>NO<sub>2</sub>PS

CAS Index Name:

**IUPAC name:**

Synonyms:

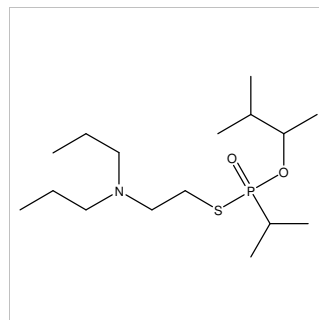

**Chemical name:** 1,2-Dimethylpropyl S-2-dipropylaminoethyl propylphosphonothiolate

Schedule: 1A03

CAS RN: HS code: 2930.90

Key: (598-75-4)-P1A3-PP

Molecular formula: C<sub>16</sub>H<sub>36</sub>NO<sub>2</sub>PS

CAS Index Name:

**IUPAC name:**

Synonyms:

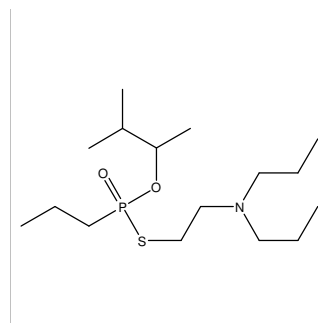

**Chemical name:** 5-Isopropyl-2-methylcyclohexyl S-2-dimethylaminoethyl ethylphosphonothiolate

Schedule: 1A03

CAS RN: HS code: 2930.90

Key: (60320-28-7)-E1A3-MM

Molecular formula: C<sub>16</sub>H<sub>34</sub>NO<sub>2</sub>PS

CAS Index Name: Phosphonothioic acid, ethyl-, S-[2-(dimethylamino)ethyl] O-5-isopropyl-2-methylcyclohexyl ester

**IUPAC name:** 5-Isopropyl-2-methylcyclohexyl S-2-dimethylaminoethyl ethylphosphonothioate

Synonyms: O-5-Isopropyl-2-methylcyclohexyl S-2-dimethylaminoethyl ethylphosphonothiolate

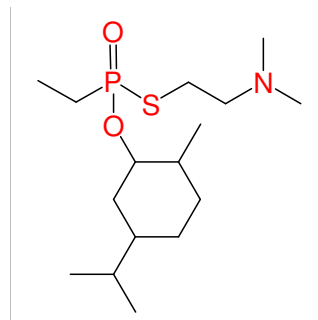

**Chemical name:** 1-Methylbutyl S-2-diethylaminoethyl isopropylphosphonothiolate

Schedule: 1A03

CAS RN: HS code: 2930.90

Key: (6032-29-7)-I1A3-EE

Molecular formula: C<sub>14</sub>H<sub>32</sub>NO<sub>2</sub>PS

CAS Index Name:

**IUPAC name:**

Synonyms:

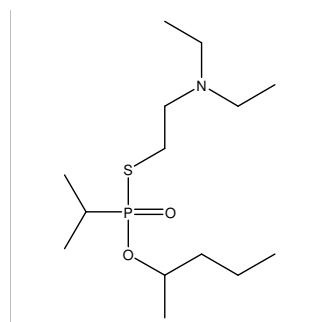

**Chemical name:** 1-Methylbutyl S-2-dipropylaminoethyl isopropylphosphonothiolate

Schedule: 1A03

CAS RN: HS code: 2930.90

Key: (6032-29-7)-I1A3-PP

Molecular formula: C<sub>16</sub>H<sub>36</sub>NO<sub>2</sub>PS

CAS Index Name:

**IUPAC name:**

Synonyms:

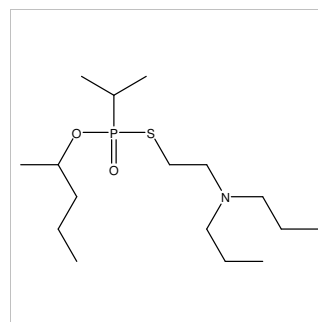

**Chemical name:** 1-Methylbutyl S-2-diethylaminoethyl  
propylphosphonothiolate

Schedule: 1A03

CAS RN: HS code: 2930.90

Key: (6032-29-7)-P1A3-EE

Molecular formula: C<sub>14</sub>H<sub>32</sub>NO<sub>2</sub>PS

CAS Index Name:

**IUPAC name:**

Synonyms:

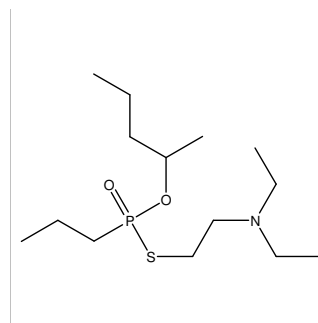

**Chemical name:** 1-Methylbutyl S-2-dipropylaminoethyl  
propylphosphonothiolate

Schedule: 1A03

CAS RN: HS code: 2930.90

Key: (6032-29-7)-P1A3-PP

Molecular formula: C<sub>16</sub>H<sub>36</sub>NO<sub>2</sub>PS

CAS Index Name:

**IUPAC name:**

Synonyms:

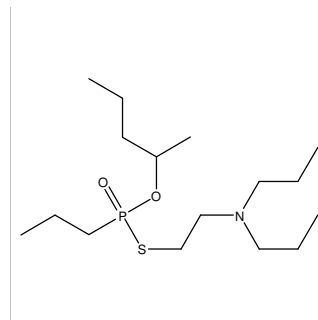

**Chemical name:** 1-Isopropylbutyl S-2-dipropylaminoethyl  
isopropylphosphonothiolate

Schedule: 1A03

CAS RN: HS code: 2930.90

Key: (617-29-8)-I1A3-PP

Molecular formula: C<sub>18</sub>H<sub>40</sub>NO<sub>2</sub>PS

CAS Index Name:

**IUPAC name:**

Synonyms:

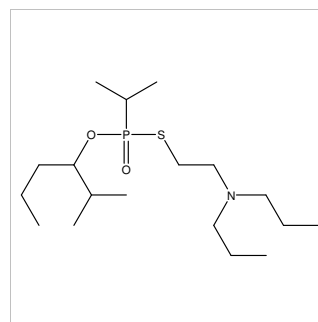

**Chemical name:** 1-Isopropylbutyl S-2-dipropylaminoethyl  
methylphosphonothiolate

Schedule: 1A03

CAS RN: HS code: 2930.90

Key: (617-29-8)-M1A3-PP

Molecular formula: C<sub>16</sub>H<sub>36</sub>NO<sub>2</sub>PS

CAS Index Name:

**IUPAC name:**

Synonyms:

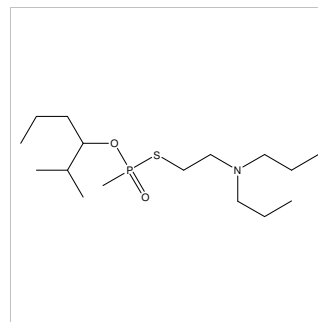



**Chemical name:** 1-Ethylbutyl S-2-dipropylaminoethyl  
isopropylphosphonothiolate

Schedule: 1A03

CAS RN: HS code: 2930.90

Key: (623-37-0)-I1A3-PP

Molecular formula: C<sub>17</sub>H<sub>38</sub>NO<sub>2</sub>PS

CAS Index Name:

**IUPAC name:**

Synonyms:

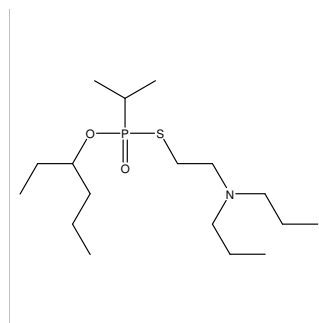

**Chemical name:** 1-Ethylbutyl S-2-dipropylaminoethyl  
methylphosphonothiolate

Schedule: 1A03

CAS RN: HS code: 2930.90

Key: (623-37-0)-M1A3-PP

Molecular formula: C<sub>15</sub>H<sub>34</sub>NO<sub>2</sub>PS

CAS Index Name: Phosphonothioic acid, methyl-, S-[2-(dipropylamino)ethyl] O-(1-ethylbutyl) ester

**IUPAC name:** 1-Ethylbutyl S-2-dipropylaminoethyl  
methylphosphonothioate

Synonyms: O-1-Ethylbutyl S-2-dipropylaminoethyl methylphosphonothiolate

Hexan-3-yl S-2-dipropylaminoethyl methylphosphonothiolate

Hex-3-yl S-2-dipropylaminoethyl methylphosphonothiolate

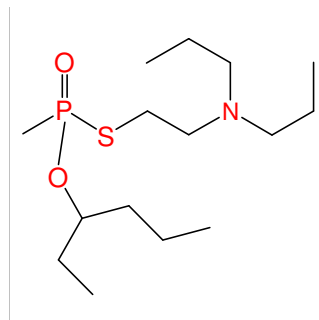

**Chemical name:** 3,3-Dimethylbutyl S-2-diethylaminoethyl  
ethylphosphonothiolate

Schedule: 1A03

CAS RN: HS code: 2930.90

Key: (624-95-3)-E1A3-EE

Molecular formula: C<sub>14</sub>H<sub>32</sub>NO<sub>2</sub>PS

CAS Index Name:

**IUPAC name:**

Synonyms:

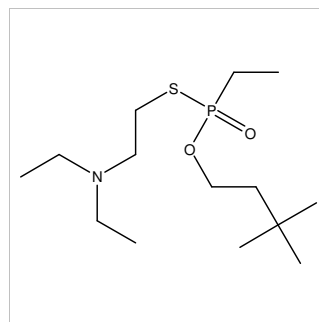

**Chemical name:** 3,3-Dimethylbutyl S-2-dipropylaminoethyl  
isopropylphosphonothiolate

Schedule: 1A03

CAS RN: HS code: 2930.90

Key: (624-95-3)-I1A3-PP

Molecular formula: C<sub>17</sub>H<sub>38</sub>NO<sub>2</sub>PS

CAS Index Name:

**IUPAC name:**

Synonyms:

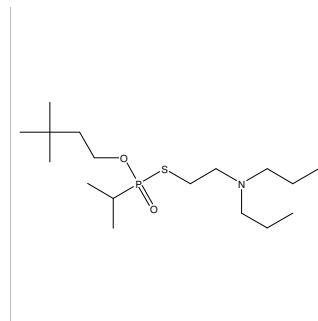

**Chemical name:** 3,3-Dimethylbutyl S-2-diethylaminoethyl  
methylphosphonothiolate

Schedule: 1A03

CAS RN: HS code: 2930.90

Key: (624-95-3)-M1A3-EE

Molecular formula: C<sub>13</sub>H<sub>30</sub>NO<sub>2</sub>PS

CAS Index Name:

**IUPAC name:**

Synonyms:

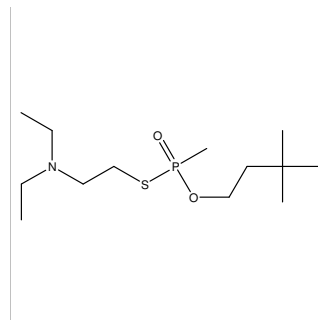

**Chemical name:** 3,3-Dimethylbutyl S-2-dipropylaminoethyl  
methylphosphonothiolate

Schedule: 1A03

CAS RN: HS code: 2930.90

Key: (624-95-3)-M1A3-PP

Molecular formula: C<sub>15</sub>H<sub>34</sub>NO<sub>2</sub>PS

CAS Index Name:

**IUPAC name:**

Synonyms:

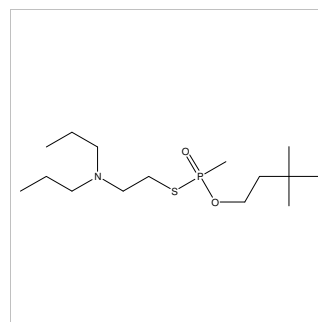

**Chemical name:** 3,3-Dimethylbutyl S-2-dipropylaminoethyl  
propylphosphonothiolate

Schedule: 1A03

CAS RN: HS code: 2930.90

Key: (624-95-3)-P1A3-PP

Molecular formula: C<sub>17</sub>H<sub>38</sub>NO<sub>2</sub>PS

CAS Index Name:

**IUPAC name:**

Synonyms:

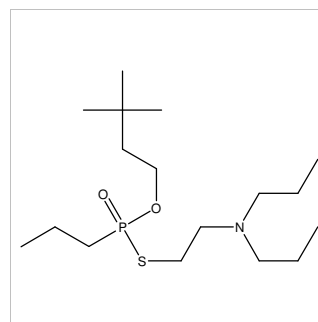

**Chemical name:** 4-Methylpentyl S-2-diethylaminoethyl ethylphosphonothiolate

Schedule: 1A03

CAS RN: HS code: 2930.90

Key: (626-89-1)-E1A3-EE

Molecular formula: C<sub>14</sub>H<sub>32</sub>NO<sub>2</sub>PS

CAS Index Name:

**IUPAC name:**

Synonyms:

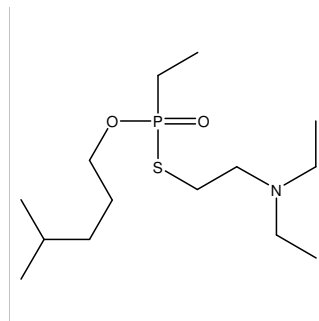

**Chemical name:** 4-Methylpentyl S-2-dipropylaminoethyl ethylphosphonothiolate

Schedule: 1A03

CAS RN: HS code: 2930.90

Key: (626-89-1)-E1A3-PP

Molecular formula: C<sub>16</sub>H<sub>36</sub>NO<sub>2</sub>PS

CAS Index Name:

**IUPAC name:**

Synonyms:

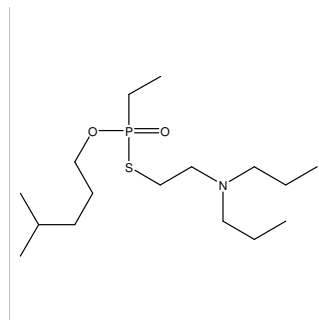

**Chemical name:** 4-Methylpentyl S-2-dipropylaminoethyl isopropylphosphonothiolate

Schedule: 1A03

CAS RN: HS code: 2930.90

Key: (626-89-1)-I1A3-PP

Molecular formula: C<sub>17</sub>H<sub>38</sub>NO<sub>2</sub>PS

CAS Index Name:

**IUPAC name:**

Synonyms:

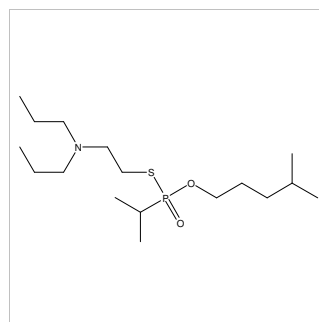

**Chemical name:** 4-Methylpentyl S-2-diethylaminoethyl methylphosphonothiolate

Schedule: 1A03

CAS RN: HS code: 2930.90

Key: (626-89-1)-M1A3-EE

Molecular formula: C<sub>13</sub>H<sub>30</sub>NO<sub>2</sub>PS

CAS Index Name:

**IUPAC name:**

Synonyms:

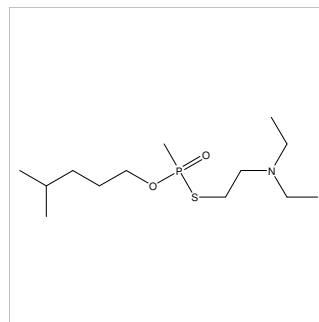

**Chemical name:** 4-Methylpentyl S-2-dipropylaminoethyl methylphosphonothiolate

Schedule: 1A03

CAS RN: HS code: 2930.90

Key: (626-89-1)-M1A3-PP

Molecular formula: C<sub>15</sub>H<sub>34</sub>NO<sub>2</sub>PS

CAS Index Name:

**IUPAC name:**

Synonyms:

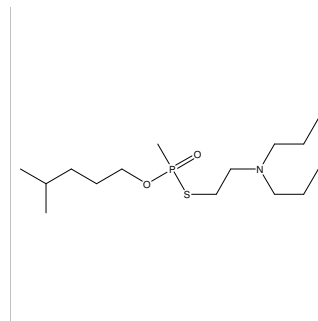

**Chemical name:** 4-Methylpentyl S-2-dipropylaminoethyl propylphosphonothiolate

Schedule: 1A03

CAS RN: HS code: 2930.90

Key: (626-89-1)-P1A3-PP

Molecular formula: C<sub>17</sub>H<sub>38</sub>NO<sub>2</sub>PS

CAS Index Name:

**IUPAC name:**

Synonyms:

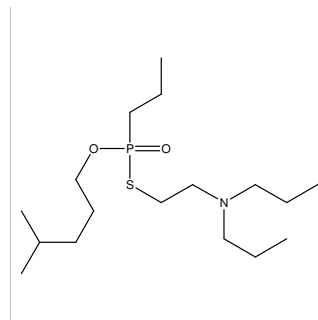

**Chemical name:** 1-Methylpentyl S-2-dipropylaminoethyl isopropylphosphonothiolate

Schedule: 1A03

CAS RN: HS code: 2930.90

Key: (626-93-7)-I1A3-PP

Molecular formula: C<sub>17</sub>H<sub>38</sub>NO<sub>2</sub>PS

CAS Index Name:

**IUPAC name:**

Synonyms:

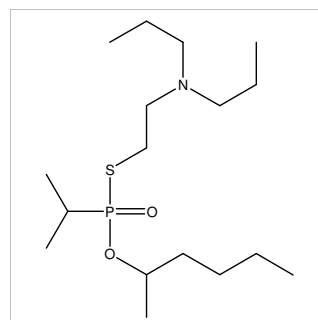

**Chemical name:** 1-Methylpentyl S-2-diisopropylaminoethyl methylphosphonothiolate

Schedule: 1A03

CAS RN: HS code: 2930.90

Key: (626-93-7)-M1A3-II

Molecular formula: C<sub>15</sub>H<sub>34</sub>NO<sub>2</sub>PS

CAS Index Name: Phosphonothioic acid, methyl-, S-[2-(bis(1-methylethyl)amino)ethyl] O-(1-methylpentyl) ester

**IUPAC name:** 1-Methylpentyl S-2-diisopropylaminoethyl methylphosphonothioate

Synonyms: Phosphonothioic acid, methyl-, S-[2-(bis(1-methylethyl)amino)ethyl] O-hex-2-yl ester

O-1-Methylpentyl S-2-diisopropylaminoethyl methylphosphonothiolate

Hexan-2-yl S-2-diisopropylaminoethyl methylphosphonothiolate

Hex-2-yl S-2-diisopropylaminoethyl methylphosphonothiolate

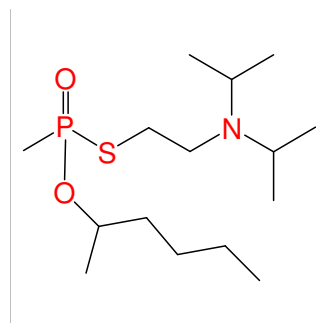

**Chemical name:** 1-Methylpentyl S-2-dipropylaminoethyl propylphosphonothiolate

Schedule: 1A03

CAS RN: HS code: 2930.90

Key: (626-93-7)-P1A3-PP

Molecular formula: C<sub>17</sub>H<sub>38</sub>NO<sub>2</sub>PS

CAS Index Name:

**IUPAC name:**

Synonyms:

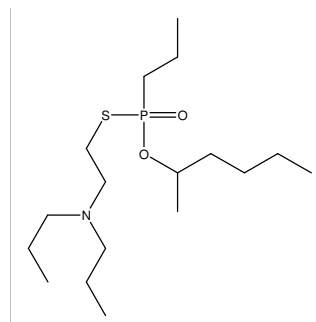

**Chemical name:** 1,4-Dimethylpentyl S-2-dipropylaminoethyl methylphosphonothiolate

Schedule: 1A03

CAS RN: HS code: 2930.90

Key: (627-59-8)-M1A3-PP

Molecular formula: C<sub>16</sub>H<sub>36</sub>NO<sub>2</sub>PS

CAS Index Name:

**IUPAC name:**

Synonyms:

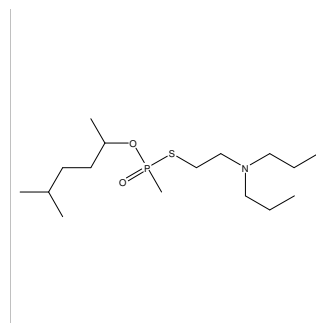

**Chemical name:** Ethyl S-2-N-ethyl-N-isopropylaminoethyl ethylphosphonothiolate

Schedule: 1A03

CAS RN: HS code: 2930.90

Key: (64-17-5)-E1A3-EI

Molecular formula: C<sub>11</sub>H<sub>26</sub>NO<sub>2</sub>PS

CAS Index Name: Phosphonothioic acid, ethyl-, S-[2-[[N-ethyl-N-(1-methylethyl)]amino]ethyl]-O-ethyl ester

**IUPAC name:**

Synonyms:

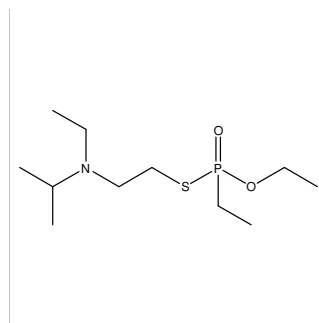

**Chemical name:** Ethyl S-2-N-ethyl-N-methylaminoethyl ethylphosphonothiolate

Schedule: 1A03

CAS RN: HS code: 2930.90

Key: (64-17-5)-E1A3-EM

Molecular formula: C<sub>9</sub>H<sub>22</sub>NO<sub>2</sub>PS

CAS Index Name:

**IUPAC name:**

Synonyms:

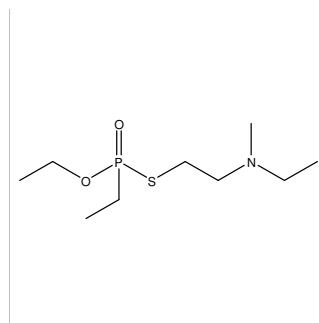

**Chemical name:** Ethyl S-2-N-ethyl-N-propylaminoethyl ethylphosphonothiolate

Schedule: 1A03

CAS RN: HS code: 2930.90

Key: (64-17-5)-E1A3-EP

Molecular formula: C<sub>11</sub>H<sub>26</sub>NO<sub>2</sub>PS

CAS Index Name:

**IUPAC name:**

Synonyms:

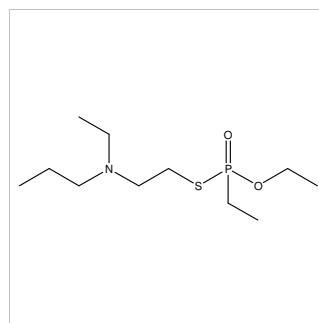

**Chemical name:** Ethyl S-2-N-methyl-N-isopropylaminoethyl ethylphosphonothiolate

Schedule: 1A03

CAS RN: HS code: 2930.90

Key: (64-17-5)-E1A3-IM

Molecular formula: C<sub>10</sub>H<sub>24</sub>NO<sub>2</sub>PS

CAS Index Name:

**IUPAC name:**

Synonyms:

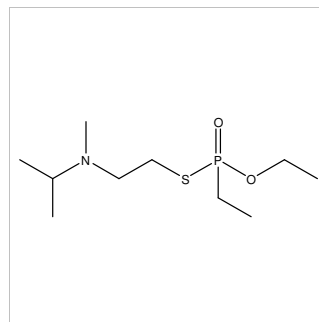

**Chemical name:** Ethyl S-2-N-isopropyl-N-propylaminoethyl ethylphosphonothiolate

Schedule: 1A03

CAS RN: HS code: 2930.90

Key: (64-17-5)-E1A3-IP

Molecular formula: C<sub>12</sub>H<sub>28</sub>NO<sub>2</sub>PS

CAS Index Name:

**IUPAC name:**

Synonyms:

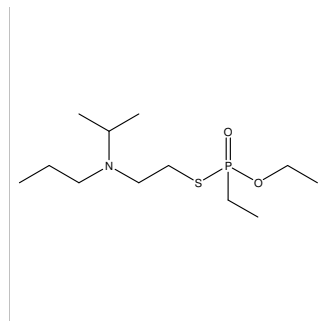

**Chemical name:** Ethyl S-2-N-methyl-N-propylaminoethyl ethylphosphonothiolate

Schedule: 1A03

CAS RN: HS code: 2930.90

Key: (64-17-5)-E1A3-MP

Molecular formula: C<sub>10</sub>H<sub>24</sub>NO<sub>2</sub>PS

CAS Index Name:

**IUPAC name:**

Synonyms:

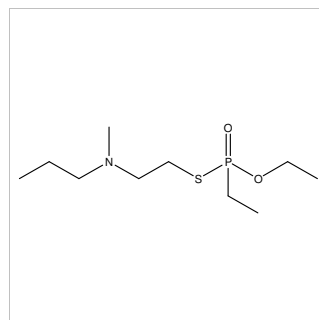

**Chemical name:** Ethyl S-2-dipropylaminoethyl ethylphosphonothiolate

Schedule: 1A03

CAS RN: HS code: 2930.90

Key: (64-17-5)-E1A3-PP

Molecular formula: C<sub>12</sub>H<sub>28</sub>NO<sub>2</sub>PS

CAS Index Name: Phosphonothioic acid, ethyl-, S-[2-(dipropylamino)ethyl] O-ethyl ester

**IUPAC name:** Ethyl S-2-dipropylaminoethyl ethylphosphonothioate

Synonyms: O-Ethyl S-2-dipropylaminoethyl ethylphosphonothiolate

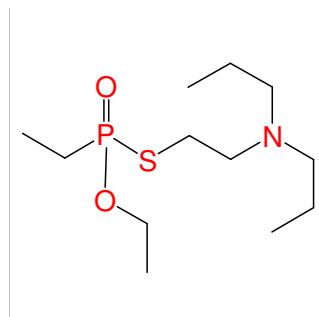

**Chemical name:** Ethyl S-2-N-ethyl-N-isopropylaminoethyl isopropylphosphonothiolate

Schedule: 1A03

CAS RN: HS code: 2930.90

Key: (64-17-5)-I1A3-EI

Molecular formula: C<sub>12</sub>H<sub>28</sub>NO<sub>2</sub>PS

CAS Index Name:

**IUPAC name:**

Synonyms:

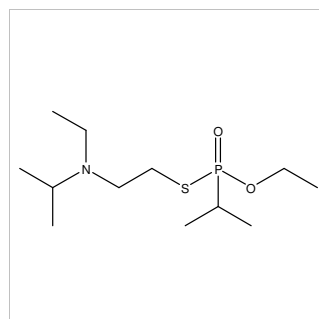

**Chemical name:** Ethyl S-2-N-ethyl-N-methylaminoethyl  
isopropylphosphonothiolate

Schedule: 1A03

CAS RN: HS code: 2930.90

Key: (64-17-5)-I1A3-EM

Molecular formula: C<sub>10</sub>H<sub>24</sub>NO<sub>2</sub>PS

CAS Index Name:

**IUPAC name:**

Synonyms:

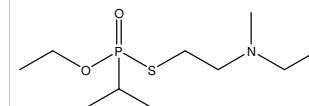

**Chemical name:** Ethyl S-2-N-ethyl-N-propylaminoethyl  
isopropylphosphonothiolate

Schedule: 1A03

CAS RN: HS code: 2930.90

Key: (64-17-5)-I1A3-EP

Molecular formula: C<sub>12</sub>H<sub>28</sub>NO<sub>2</sub>PS

CAS Index Name:

**IUPAC name:**

Synonyms:

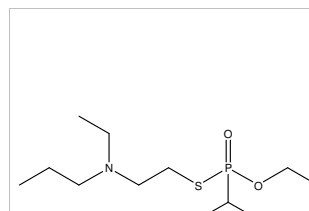

**Chemical name:** Ethyl S-2-N-isopropyl-N-methylaminoethyl  
isopropylphosphonothiolate

Schedule: 1A03

CAS RN: HS code: 2930.90

Key: (64-17-5)-I1A3-IM

Molecular formula: C<sub>11</sub>H<sub>26</sub>NO<sub>2</sub>PS

CAS Index Name:

**IUPAC name:**

Synonyms:

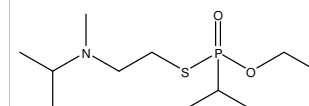

**Chemical name:** Ethyl S-2-N-isopropyl-N-propylaminoethyl  
isopropylphosphonothiolate

Schedule: 1A03

CAS RN: HS code: 2930.90

Key: (64-17-5)-I1A3-IP

Molecular formula: C<sub>13</sub>H<sub>30</sub>NO<sub>2</sub>PS

CAS Index Name:

**IUPAC name:**

Synonyms:

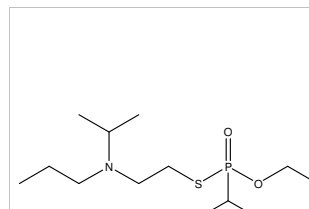



**Chemical name:** Ethyl S-2-N-methyl-N-propylaminoethyl isopropylphosphonothiolate

Schedule: 1A03

CAS RN: HS code: 2930.90

Key: (64-17-5)-I1A3-MP

Molecular formula: C<sub>11</sub>H<sub>26</sub>NO<sub>2</sub>PS

CAS Index Name:

**IUPAC name:**

Synonyms:

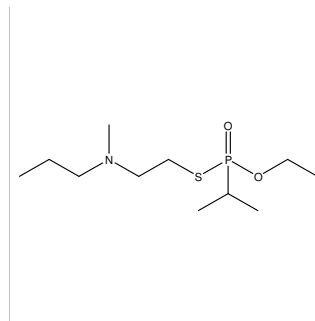

**Chemical name:** Ethyl S-2-dipropylaminoethyl isopropylphosphonothiolate

Schedule: 1A03

CAS RN: HS code: 2930.90

Key: (64-17-5)-I1A3-PP

Molecular formula: C<sub>13</sub>H<sub>30</sub>NO<sub>2</sub>PS

CAS Index Name: Phosphonothioic acid, 1-methylethyl-, S-[2-(dipropylamino)ethyl] O-ethyl ester

**IUPAC name:** Ethyl S-2-dipropylaminoethyl isopropylphosphonothioate

Synonyms: O-Ethyl S-2-dipropylaminoethyl isopropylphosphonothiolate

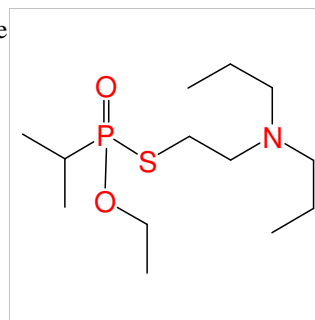

**Chemical name:** Ethyl S-2-diisopropylaminoethyl methyl-d<sub>3</sub>-phosphonothiolate

Schedule: 1A03

CAS RN: HS code: 2845.90

Key: (64-17-5)-M1A3(D3)-II

Molecular formula: C<sub>11</sub>H<sub>23</sub>D<sub>3</sub>NO<sub>2</sub>PS

CAS Index Name: Phosphonothioic acid, methyl-d<sub>3</sub>-, S-[2-(bis(1-methylethyl)amino)ethyl] O-ethyl ester

**IUPAC name:** Ethyl S-2-diisopropylaminoethyl methyl-d<sub>3</sub>-phosphonothioate

Synonyms: O-Ethyl S-2-diisopropylaminoethyl trideuteriomethylphosphonothiolate

O-Ethyl S-2-diisopropylaminoethyl methyl-d<sub>3</sub>-phosphonothiolate

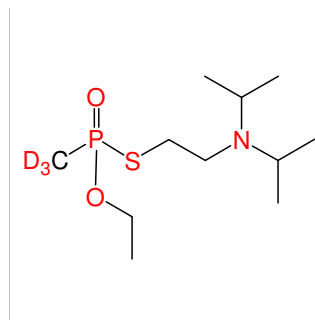

**Chemical name:** Ethyl S-2-N-ethyl-N-isopropylaminoethyl methylphosphonothiolate

Schedule: 1A03

CAS RN: HS code: 2930.90

Key: (64-17-5)-M1A3-EI

Molecular formula: C<sub>10</sub>H<sub>24</sub>NO<sub>2</sub>PS

CAS Index Name:

**IUPAC name:**

Synonyms:

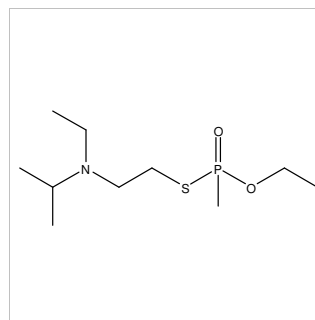

**Chemical name:** Ethyl S-2-N-ethyl-N-methylaminoethyl methylphosphonothiolate

Schedule: 1A03

CAS RN: HS code: 2930.90

Key: (64-17-5)-M1A3-EM

Molecular formula: C<sub>8</sub>H<sub>20</sub>NO<sub>2</sub>PS

CAS Index Name:

**IUPAC name:**

Synonyms:

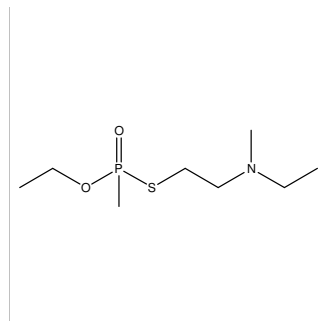

**Chemical name:** Ethyl S-2-N-ethyl-N-propylaminoethyl methylphosphonothiolate

Schedule: 1A03

CAS RN: HS code: 2930.90

Key: (64-17-5)-M1A3-EP

Molecular formula: C<sub>10</sub>H<sub>24</sub>NO<sub>2</sub>PS

CAS Index Name:

**IUPAC name:**

Synonyms:

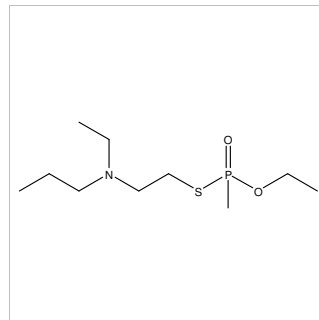

**Chemical name:** Ethyl S-2-isopropylmethylaminoethyl methylphosphonothiolate

Schedule: 1A03

CAS RN: HS code: 2930.90

Key: (64-17-5)-M1A3-IM

Molecular formula: C<sub>9</sub>H<sub>22</sub>NO<sub>2</sub>PS

CAS Index Name: Phosphonothioic acid, methyl-, S-[2-((1-methylethyl)methylamino)ethyl] O-ethyl ester

**IUPAC name:** Ethyl S-2-isopropylmethylaminoethyl methylphosphonothioate

Synonyms: O-Ethyl S-2-isopropylmethylaminoethyl methylphosphonothiolate

Ethyl S-2-(isopropylmethylamino)ethyl methylphosphonothiolate

Ethyl S-2-(isopropylmethyl)aminoethyl methylphosphonothiolate

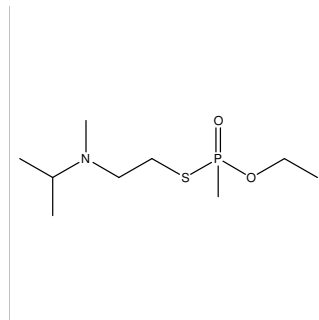

**Chemical name:** Ethyl S-2-N-isopropyl-N-propylaminoethyl methylphosphonothiolate

Schedule: 1A03

CAS RN: HS code: 2930.90

Key: (64-17-5)-M1A3-IP

Molecular formula: C<sub>11</sub>H<sub>26</sub>NO<sub>2</sub>PS

CAS Index Name:

**IUPAC name:**

Synonyms:

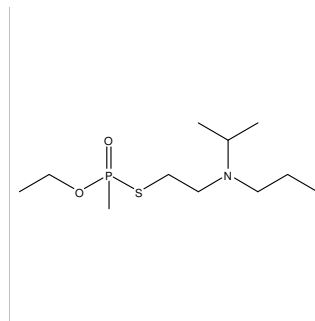

**Chemical name:** Ethyl S-2-diisopropylmethylammoniumethyl methylphosphonothiolate iodide (-)

Schedule: 1A03

CAS RN: HS code: 2930.90

Key: (64-17-5)-M1A3-MII(I)-(-)

Molecular formula: C<sub>12</sub>H<sub>29</sub>INO<sub>2</sub>PS

CAS Index Name: 2-Propanaminium, N-(2-[[ethoxy(methyl)phosphinyl]thio]ethyl)-N-(1-methylethyl)-N-methyl-, iodide (-)

**IUPAC name:** N-(2-[[Ethoxy(methyl)phosphoryl]thio]ethyl)-N-isopropyl-N-methylpropan-2-aminium iodide,(-)

Synonyms: O-Ethyl S-2-diisopropylmethylammoniumethyl methylphosphonothiolate iodide (-)

O-Ethyl S-2-(diisopropylmethylammonium) ethyl methylphosphonothiolate iodide (-)

N-(2-[[Ethoxy(methyl)phosphoryl]sulfanyl]ethyl)-N-isopropyl-N-methylpropan-2-aminium iodide,(-)

Ethanaminium, N,N-diisopropyl-N-methyl-2-[(ethoxymethylphosphinyl)thio]-, iodide (-)

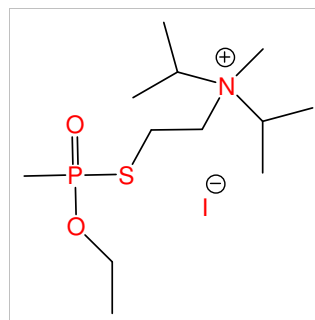

**Chemical name:** Ethyl S-2-dimethylisopropylammoniumethyl methylphosphonothiolate iodide

Schedule: 1A03

CAS RN: HS code: 2930.90

Key: (64-17-5)-M1A3-MMI(I)

Molecular formula: C<sub>10</sub>H<sub>25</sub>INO<sub>2</sub>PS

CAS Index Name: 2-Propanaminium, N-(2-[[ethoxy(methyl)phosphinyl]thio]ethyl)-N,N-dimethyl-, iodide

**IUPAC name:** N-(2-[[Ethoxy(methyl)phosphoryl]thio]ethyl)-N,N-dimethylpropan-2-aminium iodide

Synonyms: O-Ethyl S-2-dimethylisopropylammoniumethyl methylphosphonothiolate iodide

O-Ethyl S-2-(dimethylisopropylammonium)ethyl methylphosphonothiolate iodide

N-(2-[[Ethoxy(methyl)phosphoryl]sulfanyl]ethyl)-N,N-dimethylpropan-2-aminium iodide

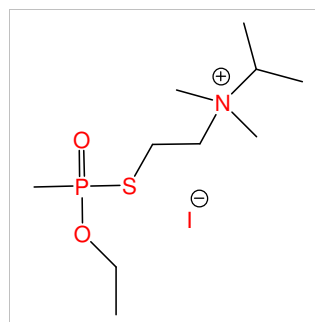

**Chemical name:** Ethyl S-2-N-methyl-N-propylaminoethyl methylphosphonothiolate

Schedule: 1A03

CAS RN: HS code: 2930.90

Key: (64-17-5)-M1A3-MP

Molecular formula: C<sub>9</sub>H<sub>22</sub>NO<sub>2</sub>PS

CAS Index Name:

**IUPAC name:**

Synonyms:

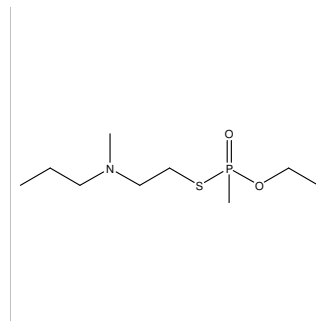

**Chemical name:** Ethyl S-2-dipropylmethylammoniumethyl methylphosphonothiolate iodide

Schedule: 1A03

CAS RN: HS code: 2930.90

Key: (64-17-5)-M1A3-MPP(I)

Molecular formula: C<sub>12</sub>H<sub>29</sub>INO<sub>2</sub>PS

CAS Index Name: 1-Propanaminium, N-{2-[Ethoxy(methyl)phosphorylthio]ethyl}-N-ethyl-N-propyl-, iodide

**IUPAC name:** N-{2-[Ethoxy(methyl)phosphorylthio]ethyl}-N-ethyl-N-propyl propan-1-aminium iodide

Synonyms: O-Ethyl S-2-dipropylmethylammoniumethyl methylphosphonothiolate iodide

N-{2-[Ethoxy(methyl)phosphorylsulfanyl]ethyl}-N-ethyl-N-propyl propan-1-aminium i

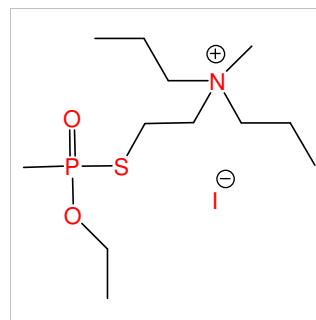

**Chemical name:** Ethyl S-2-N-ethyl-N-isopropylaminoethyl propylphosphonothiolate

Schedule: 1A03

CAS RN: HS code: 2930.90

Key: (64-17-5)-P1A3-EI

Molecular formula: C<sub>12</sub>H<sub>28</sub>NO<sub>2</sub>PS

CAS Index Name:

**IUPAC name:**

Synonyms:

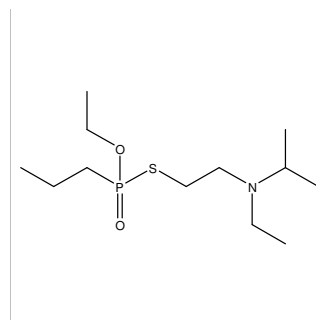

**Chemical name:** Ethyl S-2-N-ethyl-N-methylaminoethyl propylphosphonothiolate

Schedule: 1A03

CAS RN: HS code: 2930.90

Key: (64-17-5)-P1A3-EM

Molecular formula: C<sub>10</sub>H<sub>24</sub>NO<sub>2</sub>PS

CAS Index Name:

**IUPAC name:**

Synonyms:

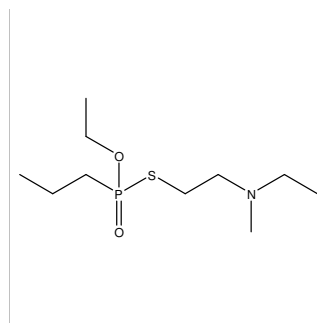

**Chemical name:** Ethyl S-2-N-ethyl-N-propylaminoethyl propylphosphonothiolate

Schedule: 1A03

CAS RN: HS code: 2930.90

Key: (64-17-5)-P1A3-EP

Molecular formula: C<sub>12</sub>H<sub>28</sub>NO<sub>2</sub>PS

CAS Index Name:

**IUPAC name:**

Synonyms:

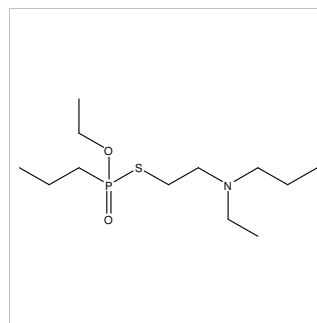

**Chemical name:** Ethyl S-2-N-isopropyl-N-methylaminoethyl propylphosphonothiolate

Schedule: 1A03

CAS RN: HS code: 2930.90

Key: (64-17-5)-P1A3-IM

Molecular formula: C<sub>11</sub>H<sub>26</sub>NO<sub>2</sub>PS

CAS Index Name:

**IUPAC name:**

Synonyms:

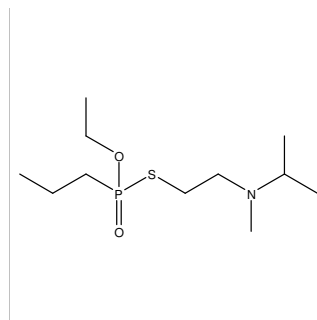

**Chemical name:** Ethyl S-2-isopropylpropylaminoethyl propylphosphonothiolate

Schedule: 1A03

CAS RN: HS code: 2930.90

Key: (64-17-5)-P1A3-IP

Molecular formula: C<sub>13</sub>H<sub>30</sub>NO<sub>2</sub>PS

CAS Index Name: Phosphonothioic acid, propyl-, S-[2-((1-methylethyl)propylamino)ethyl] O-ethyl ester

**IUPAC name:** Ethyl S-2-isopropylpropylaminoethyl propylphosphonothioate

Synonyms: O-Ethyl S-2-isopropylpropylaminoethyl propylphosphonothiolate

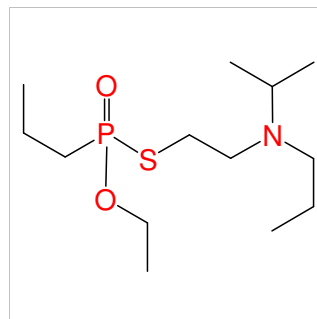

**Chemical name:** Ethyl S-2-N-methyl-N-propylaminoethyl propylphosphonothiolate

Schedule: 1A03

CAS RN: HS code: 2930.90

Key: (64-17-5)-P1A3-MP

Molecular formula: C<sub>11</sub>H<sub>26</sub>NO<sub>2</sub>PS

CAS Index Name:

**IUPAC name:**

Synonyms:

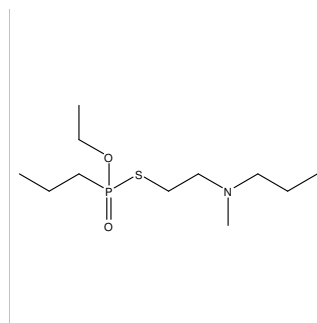

**Chemical name:** Methyl S-2-N-ethyl-N-isopropylaminoethyl ethylphosphonothiolate

Schedule: 1A03

CAS RN: HS code: 2930.90

Key: (67-56-1)-E1A3-EI

Molecular formula: C<sub>10</sub>H<sub>24</sub>NO<sub>2</sub>PS

CAS Index Name: Phosphonothioic acid, ethyl-, S-[2-[[N-ethyl-N-(1-methylethyl)]amino]ethyl]-O-methyl ester

**IUPAC name:**

Synonyms:

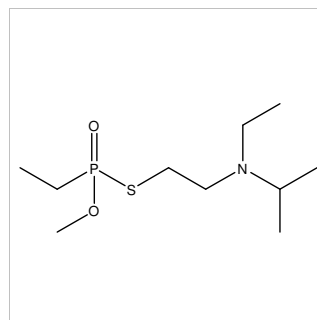

**Chemical name:** Methyl S-2-N-ethyl-N-methylaminoethyl ethylphosphonothiolate

Schedule: 1A03

CAS RN: HS code: 2930.90

Key: (67-56-1)-E1A3-EM

Molecular formula: C<sub>8</sub>H<sub>20</sub>NO<sub>2</sub>PS

CAS Index Name: Phosphonothioic acid, ethyl-, S-[2-[[N-ethyl-N-methyl]amino]ethyl]-O-methyl ester

**IUPAC name:**

Synonyms:

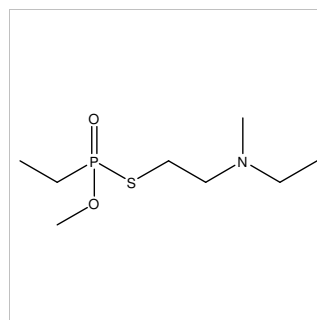

**Chemical name:** Methyl S-2-N-ethyl-N-propylaminoethyl ethylphosphonothiolate

Schedule: 1A03

CAS RN: HS code: 2930.90

Key: (67-56-1)-E1A3-EP

Molecular formula: C<sub>10</sub>H<sub>24</sub>NO<sub>2</sub>PS

CAS Index Name: Phosphonothioic acid, ethyl-, S-[2-[[N-ethyl-N-propyl]amino]ethyl]-O-methyl ester

**IUPAC name:**

Synonyms:

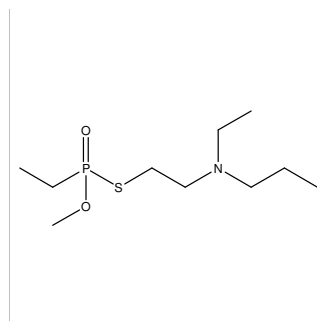

**Chemical name:** Methyl S-2-N-isopropyl-N-methylaminoethyl ethylphosphonothiolate

Schedule: 1A03

CAS RN: HS code: 2930.90

Key: (67-56-1)-E1A3-IM

Molecular formula: C<sub>9</sub>H<sub>22</sub>NO<sub>2</sub>PS

CAS Index Name: Phosphonothioic acid, ethyl-, S-[2-[[N-methyl-N-(1-methylethyl)]amino]ethyl]-O-methyl ester

**IUPAC name:**

Synonyms:

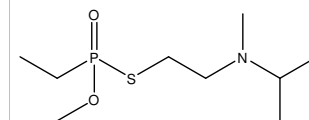

**Chemical name:** Methyl S-2-N-isopropyl-N-propyl ethylphosphonothiolate

Schedule: 1A03

CAS RN: HS code: 2930.90

Key: (67-56-1)-E1A3-IP

Molecular formula: C<sub>11</sub>H<sub>26</sub>NO<sub>2</sub>PS

CAS Index Name:

**IUPAC name:**

Synonyms:

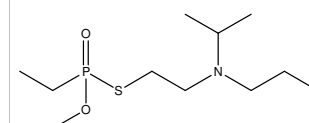

**Chemical name:** Methyl S-2-N-methyl-N-propylaminoethyl ethylphosphonothiolate

Schedule: 1A03

CAS RN: HS code: 2930.90

Key: (67-56-1)-E1A3-MP

Molecular formula: C<sub>9</sub>H<sub>22</sub>NO<sub>2</sub>PS

CAS Index Name:

**IUPAC name:**

Synonyms:

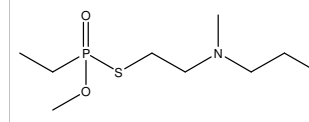

**Chemical name:** Methyl S-2-dipropylaminoethyl ethylphosphonothiolate

Schedule: 1A03

CAS RN: HS code: 2930.90

Key: (67-56-1)-E1A3-PP

Molecular formula: C<sub>11</sub>H<sub>26</sub>NO<sub>2</sub>PS

CAS Index Name: Phosphonothioic acid, ethyl-, S-[2-(dipropylamino)ethyl] O-methyl ester

**IUPAC name:** Methyl S-2-dipropylaminoethyl ethylphosphonothioate

Synonyms: O-Methyl S-2-dipropylaminoethyl ethylphosphonothiolate

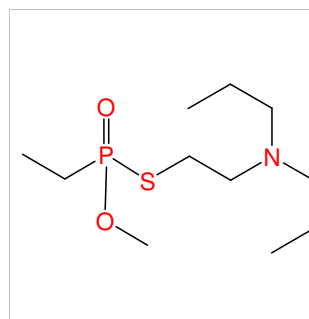

**Chemical name:** Methyl S-2-diethylaminoethyl  
isopropylphosphonothiolate

Schedule: 1A03

CAS RN: HS code: 2930.90

Key: (67-56-1)-I1A3-EE

Molecular formula: C<sub>10</sub>H<sub>24</sub>NO<sub>2</sub>PS

CAS Index Name: Phosphonothioic acid, 1-methylethyl-, S-[2-(diethylamino)ethyl] O-methyl ester

**IUPAC name:** Methyl S-2-diethylaminoethyl isopropylphosphonothioate

Synonyms: O-Methyl S-2-diethylaminoethyl isopropylphosphonothiolate

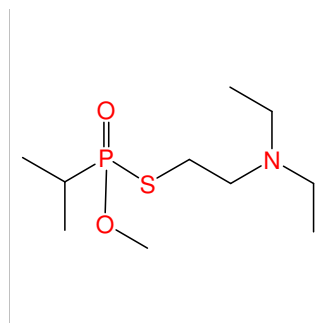

**Chemical name:** Methyl S-2-N-ethyl-N-isopropylaminoethyl  
isopropylphosphonothiolate

Schedule: 1A03

CAS RN: HS code: 2930.90

Key: (67-56-1)-I1A3-EI

Molecular formula: C<sub>11</sub>H<sub>26</sub>NO<sub>2</sub>PS

CAS Index Name: Phosphonothioic acid, 1-methylethyl-, S-[2-[[N-ethyl-N-(1-methylethyl)]amino]ethyl]-O-methyl ester

**IUPAC name:**

Synonyms:

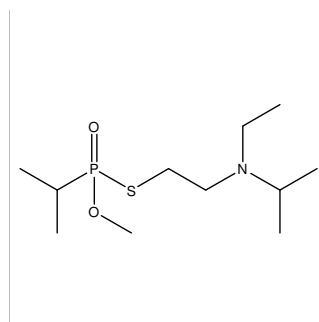

**Chemical name:** Methyl S-2-N-ethyl-N-methylaminoethyl  
isopropylphosphonothiolate

Schedule: 1A03

CAS RN: HS code: 2930.90

Key: (67-56-1)-I1A3-EM

Molecular formula: C<sub>9</sub>H<sub>22</sub>NO<sub>2</sub>PS

CAS Index Name: Phosphonothioic acid, 1-methylethyl-, S-[2-[[N-ethyl-N-methyl]amino]ethyl]-O-methyl ester

**IUPAC name:**

Synonyms:

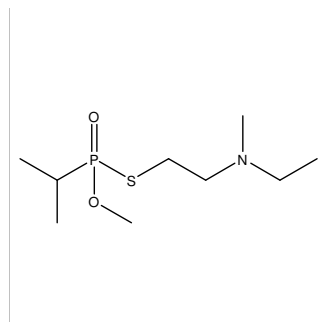

**Chemical name:** Methyl S-2-N-ethyl-N-propylaminoethyl  
isopropylphosphonothiolate

Schedule: 1A03

CAS RN: HS code: 2930.90

Key: (67-56-1)-I1A3-EP

Molecular formula: C<sub>11</sub>H<sub>26</sub>NO<sub>2</sub>PS

CAS Index Name:

**IUPAC name:**

Synonyms:

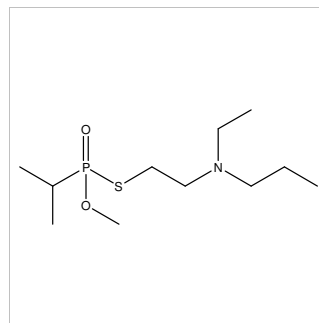



**Chemical name:** Methyl S-2-N-isopropyl-N-methylaminoethyl  
isopropylphosphonothiolate

Schedule: 1A03

CAS RN: HS code: 2930.90

Key: (67-56-1)-I1A3-IM

Molecular formula: C<sub>10</sub>H<sub>24</sub>NO<sub>2</sub>PS

CAS Index Name:

**IUPAC name:**

Synonyms:

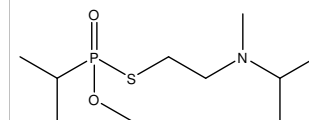

**Chemical name:** Methyl S-2-N-isopropyl-N-propylaminoethyl  
isopropylphosphonothiolate

Schedule: 1A03

CAS RN: HS code: 2930.90

Key: (67-56-1)-I1A3-IP

Molecular formula: C<sub>12</sub>H<sub>28</sub>NO<sub>2</sub>PS

CAS Index Name:

**IUPAC name:**

Synonyms:

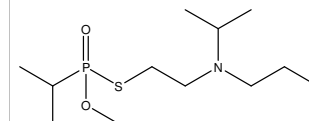

**Chemical name:** Methyl S-2-dimethylaminoethyl  
isopropylphosphonothiolate

Schedule: 1A03

CAS RN: HS code: 2930.90

Key: (67-56-1)-I1A3-MM

Molecular formula: C<sub>8</sub>H<sub>20</sub>NO<sub>2</sub>PS

CAS Index Name: Phosphonothioic acid, 1-methylethyl-, S-[2-(dimethylamino)ethyl] O-methyl ester

**IUPAC name:** Methyl S-2-dimethylaminoethyl  
isopropylphosphonothioate

Synonyms: O-Methyl S-2-dimethylaminoethyl isopropylphosphonothiolate

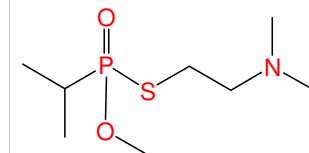

**Chemical name:** Methyl S-2-N-methyl-N-propylaminoethyl  
isopropylphosphonothiolate

Schedule: 1A03

CAS RN: HS code: 2930.90

Key: (67-56-1)-I1A3-MP

Molecular formula: C<sub>10</sub>H<sub>24</sub>NO<sub>2</sub>PS

CAS Index Name:

**IUPAC name:**

Synonyms:

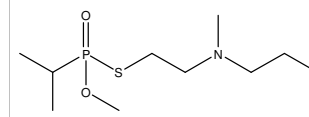

**Chemical name:** Methyl S-2-dipropylaminoethyl  
isopropylphosphonothiolate

Schedule: 1A03

CAS RN: HS code: 2930.90

Key: (67-56-1)-I1A3-PP

Molecular formula: C<sub>12</sub>H<sub>28</sub>NO<sub>2</sub>PS

CAS Index Name: Phosphonothioic acid, 1-methylethyl-, S-[2-(dipropylamino)ethyl] O-methyl ester

**IUPAC name:** Methyl S-2-dipropylaminoethyl  
isopropylphosphonothioate

Synonyms: O-Methyl S-2-dipropylaminoethyl isopropylphosphonothiolate

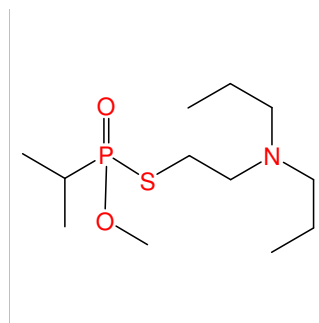

**Chemical name:** Methyl S-2-N-isopropyl-N-propylaminoethyl  
methylphosphonothiolate

Schedule: 1A03

CAS RN: HS code: 2930.90

Key: (67-56-1)-M1A3-EI

Molecular formula: C<sub>10</sub>H<sub>24</sub>NO<sub>2</sub>PS

CAS Index Name:

**IUPAC name:**

Synonyms:

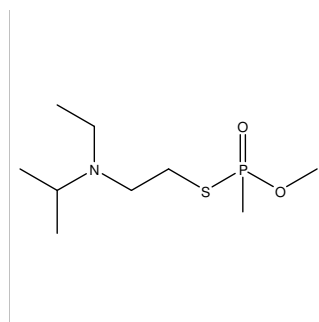

**Chemical name:** Methyl S-2-N-ethyl-N-methylaminoethyl  
methylphosphonothiolate

Schedule: 1A03

CAS RN: HS code: 2930.90

Key: (67-56-1)-M1A3-EM

Molecular formula: C<sub>7</sub>H<sub>18</sub>NO<sub>2</sub>PS

CAS Index Name:

**IUPAC name:**

Synonyms:

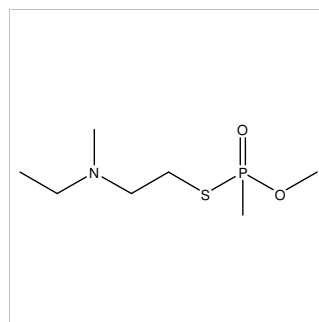

**Chemical name:** Methyl S-2-N-ethyl-N-propylaminoethyl  
methylphosphonothiolate

Schedule: 1A03

CAS RN: HS code: 2930.90

Key: (67-56-1)-M1A3-EP

Molecular formula: C<sub>9</sub>H<sub>22</sub>NO<sub>2</sub>PS

CAS Index Name:

**IUPAC name:**

Synonyms:

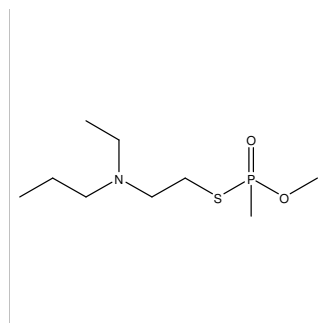

**Chemical name:** Methyl S-2-N-methyl-N-propylaminoethyl methylphosphonothiolate

Schedule: 1A03

CAS RN: HS code: 2930.90

Key: (67-56-1)-M1A3-MP

Molecular formula: C<sub>8</sub>H<sub>20</sub>NO<sub>2</sub>PS

CAS Index Name:

**IUPAC name:**

Synonyms:

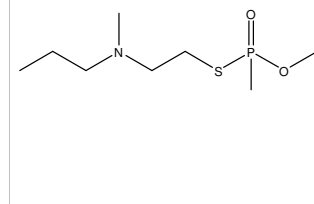

**Chemical name:** Methyl S-2-dipropylaminoethyl methylphosphonothiolate

Schedule: 1A03

CAS RN: HS code: 2930.90

Key: (67-56-1)-M1A3-PP

Molecular formula: C<sub>10</sub>H<sub>24</sub>NO<sub>2</sub>PS

CAS Index Name: Phosphonothioic acid, methy-, S-[2-(dipropylamino)ethyl] O-methyl ester

**IUPAC name:** Methyl S-2-dipropylaminoethyl methylphosphonothioate

Synonyms: O-Methyl S-2-dipropylaminoethyl methylphosphonothiolate

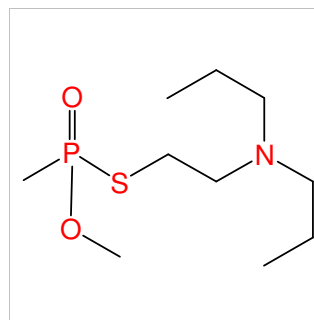

**Chemical name:** Methyl S-2-diethylaminoethyl propylphosphonothiolate

Schedule: 1A03

CAS RN: HS code: 2930.90

Key: (67-56-1)-P1A3-EE

Molecular formula: C<sub>10</sub>H<sub>24</sub>NO<sub>2</sub>PS

CAS Index Name: Phosphonothioic acid, propyl-, S-[2-(diethylamino)ethyl] O-methyl ester

**IUPAC name:** Methyl S-2-diethylaminoethyl propylphosphonothioate

Synonyms: O-Methyl S-2-diethylaminoethyl propylphosphonothiolate

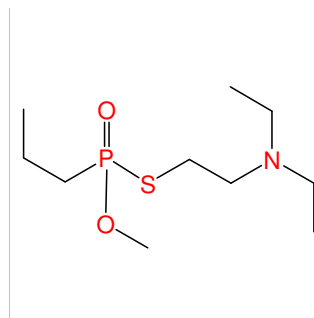

**Chemical name:** Methyl S-2-diethylmethylammoniummethyl propylphosphonothiolate iodide

Schedule: 1A03

CAS RN: HS code: 2930.90

Key: (67-56-1)-P1A3-EEM(I)

Molecular formula: C<sub>11</sub>H<sub>27</sub>INO<sub>2</sub>PS

CAS Index Name: Ethanaminium, N,N-diethyl-2-[[methoxy(propyl)phosphoryl]thio]-N-methyl-, iodide

**IUPAC name:** N,N-Diethyl-2-[[methoxy(propyl)phosphoryl]thio]-N-methylethanaminium iodide

Synonyms: O-Methyl S-2-diethylmethylammoniummethyl propylphosphonothiolate iodide

N,N-Diethyl-2-[[methoxy(propyl)phosphoryl]sulfanyl]-N-methylethanaminium iodide

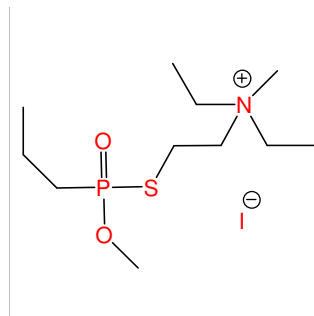

**Chemical name:** Methyl S-2-N-ethyl-N-isopropylaminoethyl propylphosphonothiolate

Schedule: 1A03

CAS RN: HS code: 2930.90

Key: (67-56-1)-P1A3-EI

Molecular formula: C<sub>11</sub>H<sub>26</sub>NO<sub>2</sub>PS

CAS Index Name:

**IUPAC name:**

Synonyms:

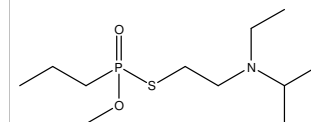

**Chemical name:** Methyl S-2-N-ethyl-N-methylaminoethyl propylphosphonothiolate

Schedule: 1A03

CAS RN: HS code: 2930.90

Key: (67-56-1)-P1A3-EM

Molecular formula: C<sub>9</sub>H<sub>22</sub>NO<sub>2</sub>PS

CAS Index Name:

**IUPAC name:**

Synonyms:

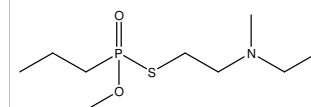

**Chemical name:** Methyl S-2-N-ethyl-N-propylaminoethyl propylphosphonothiolate

Schedule: 1A03

CAS RN: HS code: 2930.90

Key: (67-56-1)-P1A3-EP

Molecular formula: C<sub>11</sub>H<sub>26</sub>NO<sub>2</sub>PS

CAS Index Name:

**IUPAC name:**

Synonyms:

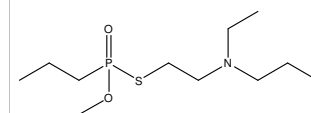

**Chemical name:** Methyl S-2-N-isopropyl-N-methylaminoethyl propylphosphonothiolate

Schedule: 1A03

CAS RN: HS code: 2930.90

Key: (67-56-1)-P1A3-IM

Molecular formula: C<sub>10</sub>H<sub>24</sub>NO<sub>2</sub>PS

CAS Index Name:

**IUPAC name:**

Synonyms:

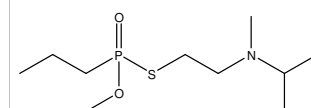

**Chemical name:** Methyl S-2-N-isopropyl-N-propylaminoethyl propylphosphonothiolate

Schedule: 1A03

CAS RN: HS code: 2930.90

Key: (67-56-1)-P1A3-IP

Molecular formula: C<sub>12</sub>H<sub>28</sub>NO<sub>2</sub>PS

CAS Index Name:

**IUPAC name:**

Synonyms:

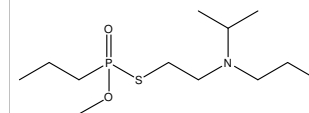

**Chemical name:** Methyl S-2-dimethylaminoethyl propylphosphonothiolate

Schedule: 1A03

CAS RN: HS code: 2930.90

Key: (67-56-1)-P1A3-MM

Molecular formula: C<sub>8</sub>H<sub>20</sub>NO<sub>2</sub>PS

CAS Index Name: Phosphonothioic acid, propyl-, S-[2-(dimethylamino)ethyl] O-methyl ester

**IUPAC name:** Methyl S-2-dimethylaminoethyl propylphosphonothioate

Synonyms: O-Methyl S-2-dimethylaminoethyl propylphosphonothiolate

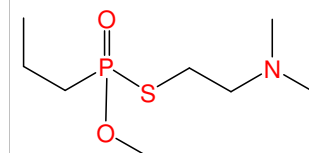

**Chemical name:** Methyl S-2-N-methyl-N-propylaminoethyl propylphosphonothiolate

Schedule: 1A03

CAS RN: HS code: 2930.90

Key: (67-56-1)-P1A3-MP

Molecular formula: C<sub>10</sub>H<sub>24</sub>NO<sub>2</sub>PS

CAS Index Name:

**IUPAC name:**

Synonyms:

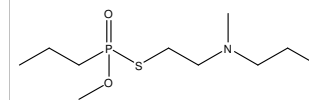

**Chemical name:** Methyl S-2-dipropylaminoethyl propylphosphonothiolate

Schedule: 1A03

CAS RN: HS code: 2930.90

Key: (67-56-1)-P1A3-PP

Molecular formula: C<sub>12</sub>H<sub>28</sub>NO<sub>2</sub>PS

CAS Index Name: Phosphonothioic acid, propyl-, S-[2-(dipropylamino)ethyl] O-methyl ester

**IUPAC name:** Methyl S-2-dipropylaminoethyl propylphosphonothioate

Synonyms: O-Methyl S-2-dipropylaminoethyl propylphosphonothiolate

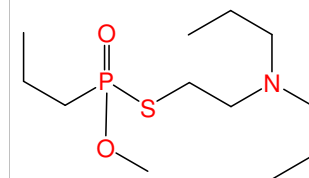

**Chemical name:** Isopropyl S-2-N-ethyl-N-isopropylaminoethyl ethylphosphonothiolate

Schedule: 1A03

CAS RN:

HS code: 2930.90

Key: (67-63-0)-E1A3-EI

Molecular formula: C<sub>12</sub>H<sub>28</sub>NO<sub>2</sub>PS

CAS Index Name:

**IUPAC name:**

Synonyms:

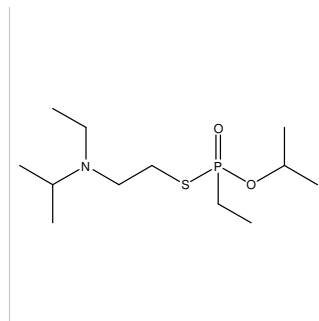

**Chemical name:** Isopropyl S-2-N-ethyl-N-methylaminoethyl ethylphosphonothiolate

Schedule: 1A03

CAS RN:

HS code: 2930.90

Key: (67-63-0)-E1A3-EM

Molecular formula: C<sub>10</sub>H<sub>24</sub>NO<sub>2</sub>PS

CAS Index Name:

**IUPAC name:**

Synonyms:

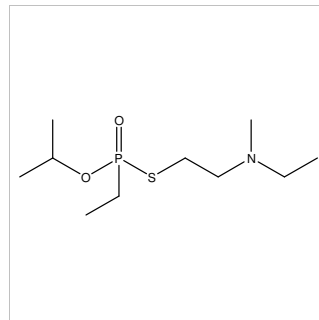

**Chemical name:** Isopropyl S-2-N-ethyl-N-propylaminoethyl ethylphosphonothiolate

Schedule: 1A03

CAS RN:

HS code: 2930.90

Key: (67-63-0)-E1A3-EP

Molecular formula: C<sub>12</sub>H<sub>28</sub>NO<sub>2</sub>PS

CAS Index Name:

**IUPAC name:**

Synonyms:

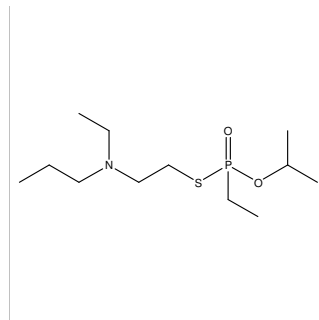

**Chemical name:** Isopropyl S-2-diisopropylmethylammoniummethyl ethylphosphonothiolate iodide

Schedule: 1A03

CAS RN: HS code: 2930.90

Key: (67-63-0)-E1A3-IIM(I)

Molecular formula: C<sub>14</sub>H<sub>33</sub>INO<sub>2</sub>PS

CAS Index Name: 2-Propanaminium, N-(2-[[ethyl(1-methylethoxy)phosphinyl]thio]ethyl)-N-(1-methylethyl)-N-methyl-, iodide

**IUPAC name:** N-(2-[[Ethyl(isopropoxy)phosphoryl]thio]ethyl)-N-isopropyl-N-methylpropan-2-aminium iodide

Synonyms: O-Isopropyl S-2-diisopropylmethylammoniummethyl ethylphosphonothiolate iodide

O-Isopropyl S-2-(diisopropylmethylammonium)ethyl ethylphosphonothiolate iodide

N-(2-[[Ethyl(1-methylethoxy)phosphoryl]sulfanyl]ethyl)-N-isopropyl-N-methylpropylaminium iodide

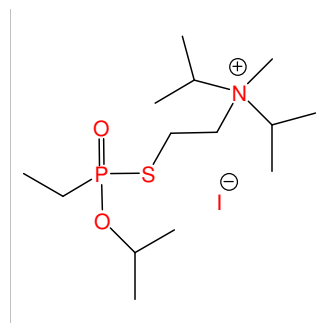

**Chemical name:** Isopropyl S-2-diisopropylmethylammoniummethyl ethylphosphonothiolate iodide (-)

Schedule: 1A03

CAS RN: HS code: 2930.90

Key: (67-63-0)-E1A3-IIM(I)(-)

Molecular formula: C<sub>14</sub>H<sub>33</sub>INO<sub>2</sub>PS

CAS Index Name: 2-Propanaminium, N-(2-[[ethyl(1-methylethoxy)phosphinyl]thio]ethyl)-N-(1-methylethyl)-N-methyl-, iodide (-)

**IUPAC name:** N-(2-[[Ethyl(1-methylethoxy)phosphoryl]thio]ethyl)-N-isopropyl-N-methylpropan-2-aminium iodide

Synonyms: O-Isopropyl S-2-diisopropylmethylammoniummethyl ethylphosphonothiolate iodide (-)

O-Isopropyl S-2 (diisopropylmethylammonium)ethyl ethylphosphonothiolate iodide (-)

N-(2-[[Ethyl(1-methylethoxy)phosphoryl]sulfanyl]ethyl)-N-isopropyl-N-methylpropylaminium iodide (-)

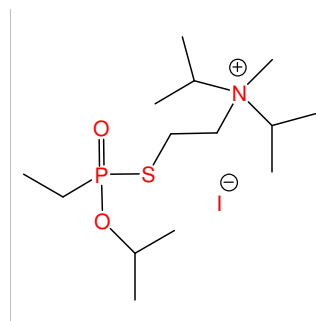

**Chemical name:** Isopropyl S-2-N-isopropyl-N-methylaminoethyl ethylphosphonothiolate

Schedule: 1A03

CAS RN: HS code: 2930.90

Key: (67-63-0)-E1A3-IM

Molecular formula: C<sub>11</sub>H<sub>26</sub>NO<sub>2</sub>PS

CAS Index Name:

**IUPAC name:**

Synonyms:

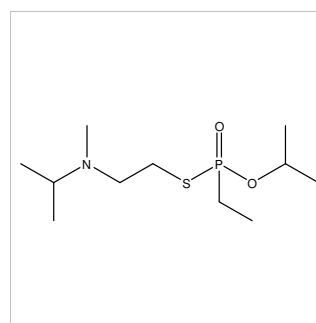

**Chemical name:** Isopropyl S-2-N-isopropyl-N-propylaminoethyl ethylphosphonothiolate

Schedule: 1A03

CAS RN: HS code: 2930.90

Key: (67-63-0)-E1A3-IP

Molecular formula: C<sub>13</sub>H<sub>30</sub>NO<sub>2</sub>PS

CAS Index Name:

**IUPAC name:**

Synonyms:

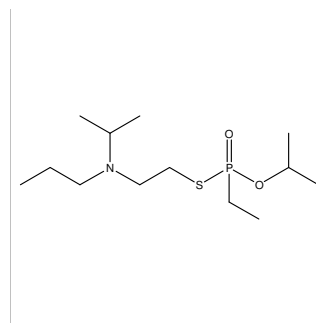

**Chemical name:** Isopropyl S-2-N-methyl-N-propylaminoethyl ethylphosphonothiolate

Schedule: 1A03

CAS RN: HS code: 2930.90

Key: (67-63-0)-E1A3-MP

Molecular formula: C<sub>11</sub>H<sub>26</sub>NO<sub>2</sub>PS

CAS Index Name:

**IUPAC name:**

Synonyms:

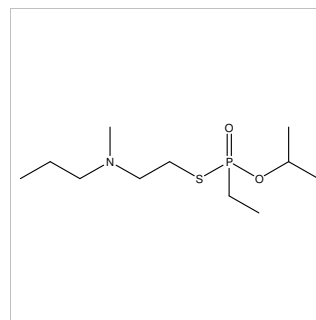

**Chemical name:** Isopropyl S-2-diethylaminoethyl isopropylphosphonothiolate

Schedule: 1A03

CAS RN: HS code: 2930.90

Key: (67-63-0)I1A3-EE

Molecular formula: C<sub>12</sub>H<sub>28</sub>NO<sub>2</sub>PS

CAS Index Name: Phosphonothioic acid, 1-methylethyl-, S-[2-(diethylamino)ethyl] O-(1-methylethyl) ester

**IUPAC name:** Isopropyl S-2-diethylaminoethyl isopropylphosphonothioate

Synonyms: Phosphonothioic acid, 1-methylethyl-, S-[2-(diethylamino)ethyl] O-1-methylethyl ester  
O-Isopropyl S-2-diethylaminoethyl isopropylphosphonothiolate

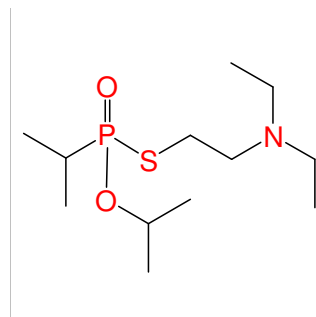

**Chemical name:** Isopropyl S-2-N-ethyl-N-isopropylaminoethyl isopropylphosphonothiolate

Schedule: 1A03

CAS RN: HS code: 2930.90

Key: (67-63-0)-I1A3-EI

Molecular formula: C<sub>13</sub>H<sub>30</sub>NO<sub>2</sub>PS

CAS Index Name:

**IUPAC name:**

Synonyms:

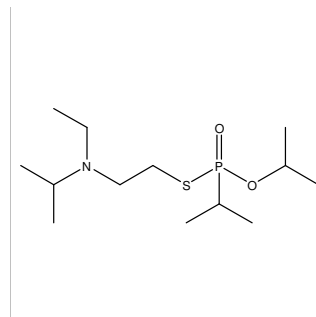



**Chemical name:** Isopropyl S-2-N-ethyl-N-methylaminoethyl  
isopropylphosphonothiolate

Schedule: 1A03

CAS RN: HS code: 2930.90

Key: (67-63-0)-I1A3-EM

Molecular formula: C<sub>11</sub>H<sub>26</sub>NO<sub>2</sub>PS

CAS Index Name:

**IUPAC name:**

Synonyms:

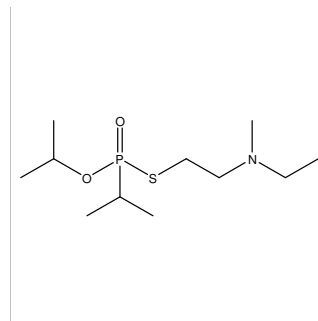

**Chemical name:** Isopropyl S-2-N-ethyl-N-propylaminoethyl  
isopropylphosphonothiolate

Schedule: 1A03

CAS RN: HS code: 2930.90

Key: (67-63-0)-I1A3-EP

Molecular formula: C<sub>13</sub>H<sub>30</sub>NO<sub>2</sub>PS

CAS Index Name:

**IUPAC name:**

Synonyms:

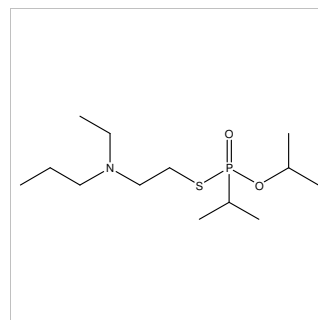

**Chemical name:** Isopropyl S-2-diisopropylmethylammoniummethyl  
isopropylphosphonothiolate iodide

Schedule: 1A03

CAS RN: HS code: 2930.90

Key: (67-63-0)-I1A3-IIM(I)

Molecular formula: C<sub>15</sub>H<sub>35</sub>INO<sub>2</sub>PS

CAS Index Name: 2-Propanaminium, N-{2-[isopropoxy(isopropyl)phosphorylthio]ethyl}-N-isopropyl-N-methyl-, iodide

**IUPAC name:** N-{2-[isopropoxy(isopropyl)phosphorylthio]ethyl}-N-isopropyl-N-methylpropan-2-aminium iodide

Synonyms: Phosphonothioic acid, 1-methylethyl, O-(1-methylethyl)-S-[2-[bis(1-methylethyl)methylammonium]ethyl] ester, iodide

O-Isopropyl S-2-diisopropylmethylammoniummethyl isopropylphosphonothiolate iodide

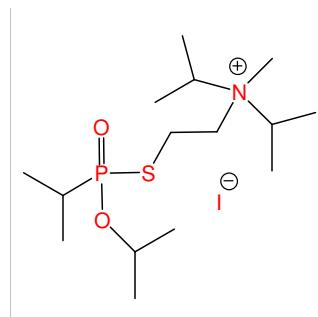

**Chemical name:** Isopropyl S-2-N-methyl-N-isopropylaminoethyl isopropylphosphonothiolate

Schedule: 1A03

CAS RN: HS code: 2930.90

Key: (67-63-0)-I1A3-IM

Molecular formula: C<sub>12</sub>H<sub>28</sub>NO<sub>2</sub>PS

CAS Index Name:

**IUPAC name:**

Synonyms:

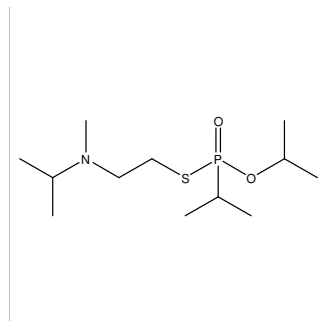

**Chemical name:** Isopropyl S-2-N-isopropyl-N-propylaminoethyl isopropylphosphonothiolate

Schedule: 1A03

CAS RN: HS code: 2930.90

Key: (67-63-0)-I1A3-IP

Molecular formula: C<sub>14</sub>H<sub>32</sub>NO<sub>2</sub>PS

CAS Index Name:

**IUPAC name:**

Synonyms:

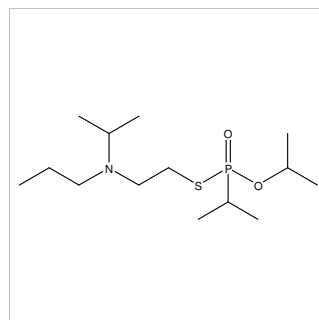

**Chemical name:** Isopropyl S-2-dimethylaminoethyl isopropylphosphonothiolate

Schedule: 1A03

CAS RN: HS code: 2930.90

Key: (67-63-0)-I1A3-MM

Molecular formula: C<sub>10</sub>H<sub>24</sub>NO<sub>2</sub>PS

CAS Index Name: Phosphonothioic acid, 1-methylethyl-, S-[2-(dimethylamino)ethyl] O-(1-methylethyl) ester

**IUPAC name:** Isopropyl S-2-dimethylaminoethyl isopropylphosphonothioate

Synonyms: Phosphonothioic acid, 1-methylethyl-, S-[2-(dimethylamino)ethyl] O-1-methylethyl est  
O-Isopropyl S-2-dimethylaminoethyl isopropylphosphonothiolate

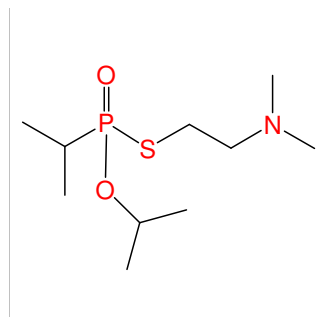

**Chemical name:** Isopropyl S-2-N-methyl-N-propylaminoethyl isopropylphosphonothiolate

Schedule: 1A03

CAS RN: HS code: 2930.90

Key: (67-63-0)-I1A3-MP

Molecular formula: C<sub>12</sub>H<sub>28</sub>NO<sub>2</sub>PS

CAS Index Name:

**IUPAC name:**

Synonyms:

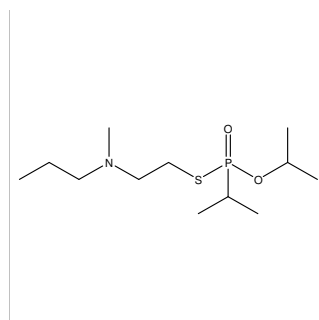

**Chemical name:** Isopropyl S-2-dipropylmethylammoniumethyl isopropylphosphonothiolate iodide

Schedule: 1A03

CAS RN: HS code: 2930.90

Key: (67-63-0)-I1A3-MPP(I)

Molecular formula: C<sub>15</sub>H<sub>35</sub>INO<sub>2</sub>PS

CAS Index Name: 1-Propanaminium, N-{2-[isopropoxy(isopropyl)phosphorylthio]ethyl}-N-methyl-N-propyl-, iodide

**IUPAC name:** N-(2-(isopropoxy(isopropyl)phosphorylthio)ethyl)-N-methyl-N-propylpropan-1-aminium iodide

Synonyms: O-Isopropyl S-2-dipropylmethylammoniumethyl isopropylphosphonothiolate iodide

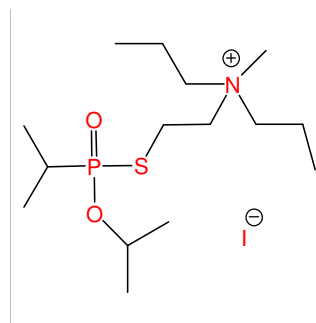

**Chemical name:** Isopropyl S-2-dipropylaminoethyl isopropylphosphonothiolate

Schedule: 1A03

CAS RN: HS code: 2930.90

Key: (67-63-0)-I1A3-PP

Molecular formula: C<sub>14</sub>H<sub>32</sub>NO<sub>2</sub>PS

CAS Index Name: Phosphonothioic acid, 1-methylethyl-, S-[2-(dipropylamino)ethyl] O-(1-methylethyl) ester

**IUPAC name:** Isopropyl S-2-dipropylaminoethyl isopropylphosphonothioate

Synonyms: Phosphonothioic acid, 1-methylethyl-, S-[2-(dipropylamino)ethyl] O-1-methylethyl ester  
O-Isopropyl S-2-dipropylaminoethyl isopropylphosphonothiolate

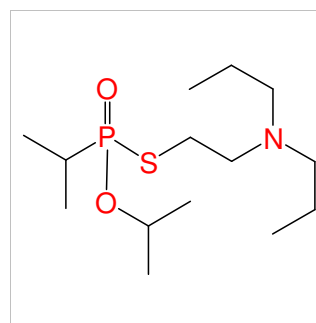

**Chemical name:** Isopropyl S-2-N-ethyl-N-isopropylaminoethyl methylphosphonothiolate

Schedule: 1A03

CAS RN: HS code: 2930.90

Key: (67-63-0)-M1A3-EI

Molecular formula: C<sub>11</sub>H<sub>26</sub>NO<sub>2</sub>PS

CAS Index Name:

**IUPAC name:**

Synonyms:

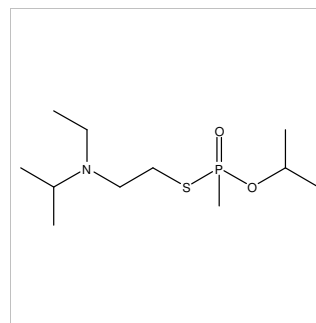

**Chemical name:** Isopropyl S-2-N-ethyl-N-methylaminoethyl methylphosphonothiolate

Schedule: 1A03

CAS RN: HS code: 2930.90

Key: (67-63-0)-M1A3-EM

Molecular formula: C<sub>9</sub>H<sub>22</sub>NO<sub>2</sub>PS

CAS Index Name:

**IUPAC name:**

Synonyms:

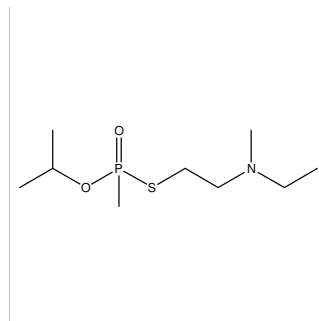

**Chemical name:** Isopropyl S-2-N-ethyl-N-propylaminoethyl methylphosphonothiolate

Schedule: 1A03

CAS RN: HS code: 2930.90

Key: (67-63-0)-M1A3-EP

Molecular formula: C<sub>11</sub>H<sub>26</sub>NO<sub>2</sub>PS

CAS Index Name:

**IUPAC name:**

Synonyms:

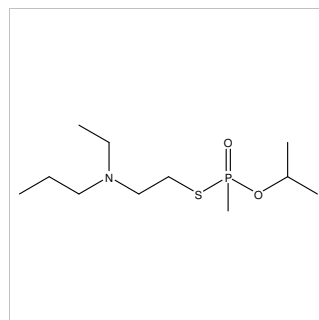

**Chemical name:** Isopropyl S-2-N-isopropyl-N-methylaminoethyl methylphosphonothiolate

Schedule: 1A03

CAS RN: HS code: 2930.90

Key: (67-63-0)-M1A3-IM

Molecular formula: C<sub>10</sub>H<sub>24</sub>NO<sub>2</sub>PS

CAS Index Name:

**IUPAC name:**

Synonyms:

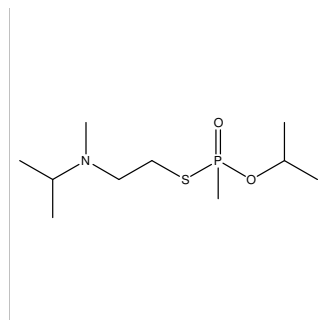

**Chemical name:** Isopropyl S-2-N-isopropyl-N-propylaminoethyl methylphosphonothiolate

Schedule: 1A03

CAS RN: HS code: 2930.90

Key: (67-63-0)-M1A3-IP

Molecular formula: C<sub>12</sub>H<sub>28</sub>NO<sub>2</sub>PS

CAS Index Name:

**IUPAC name:**

Synonyms:

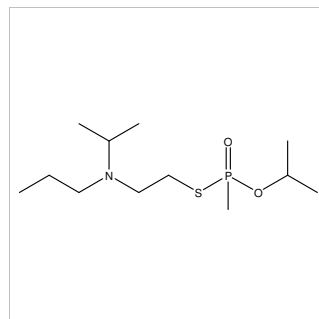

**Chemical name:** Isopropyl S-2-N-methyl-N-propylaminoethyl methylphosphonothiolate

Schedule: 1A03

CAS RN: HS code: 2930.90

Key: (67-63-0)-M1A3-MP

Molecular formula: C<sub>10</sub>H<sub>24</sub>NO<sub>2</sub>PS

CAS Index Name:

**IUPAC name:**

Synonyms:

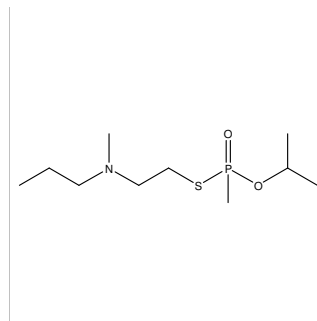

**Chemical name:** Isopropyl S-2-N-ethyl-N-isopropylaminoethyl propylphosphonothiolate

Schedule: 1A03

CAS RN: HS code: 2930.90

Key: (67-63-0)-P1A3-EI

Molecular formula: C<sub>13</sub>H<sub>30</sub>NO<sub>2</sub>PS

CAS Index Name:

**IUPAC name:**

Synonyms:

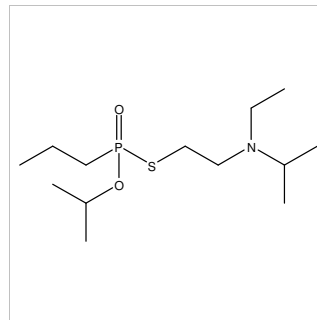

**Chemical name:** Isopropyl S-2-N-ethyl-N-methylaminoethyl propylphosphonothiolate

Schedule: 1A03

CAS RN: HS code: 2930.90

Key: (67-63-0)-P1A3-EM

Molecular formula: C<sub>11</sub>H<sub>26</sub>NO<sub>2</sub>PS

CAS Index Name:

**IUPAC name:**

Synonyms:

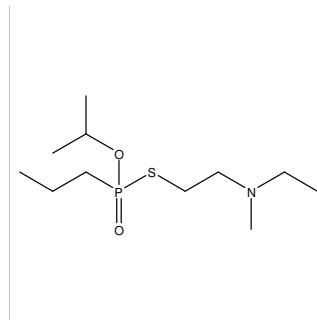

**Chemical name:** Isopropyl S-2-N-ethyl-N-propylaminoethyl propylphosphonothiolate

Schedule: 1A03

CAS RN: HS code: 2930.90

Key: (67-63-0)-P1A3-EP

Molecular formula: C<sub>13</sub>H<sub>30</sub>NO<sub>2</sub>PS

CAS Index Name:

**IUPAC name:**

Synonyms:

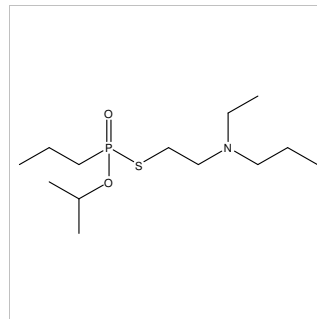

**Chemical name:** Isopropyl S-2-diisopropylaminoethyl propylphosphonothiolate

Schedule: 1A03

CAS RN: HS code: 2930.90

Key: (67-63-0)-P1A3-II

Molecular formula: C<sub>14</sub>H<sub>32</sub>NO<sub>2</sub>PS

CAS Index Name: Phosphonothioic acid, propyl-, S-[2-(bis(1-methylethyl)amino)ethyl] O-(1-methylethyl) ester

**IUPAC name:** Isopropyl S-2-diisopropylaminoethyl propylphosphonothioate

Synonyms: Phosphonothioic acid, propyl-, S-[2-(bis(1-methylethyl)amino)ethyl] O-1-methylethyl ester  
O-Isopropyl S-2-diisopropylaminoethyl propylphosphonothiolate

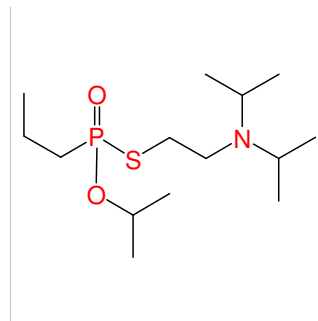

**Chemical name:** Isopropyl S-2-N-isopropyl-N-methylaminoethyl propylphosphonothiolate

Schedule: 1A03

CAS RN: HS code: 2930.90

Key: (67-63-0)-P1A3-IM

Molecular formula: C<sub>12</sub>H<sub>28</sub>NO<sub>2</sub>PS

CAS Index Name:

**IUPAC name:**

Synonyms:

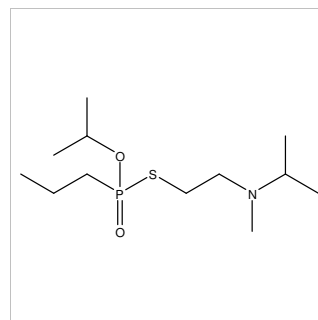

**Chemical name:** Isopropyl S-2-N-isopropyl-N-propylaminoethyl propylphosphonothiolate

Schedule: 1A03

CAS RN: HS code: 2930.90

Key: (67-63-0)-P1A3-IP

Molecular formula: C<sub>14</sub>H<sub>32</sub>NO<sub>2</sub>PS

CAS Index Name:

**IUPAC name:**

Synonyms:

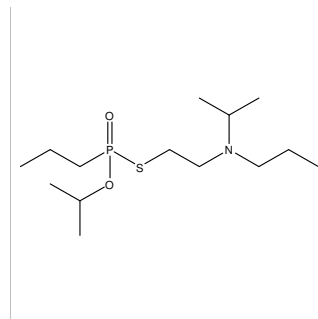

**Chemical name:** Isopropyl S-2-dimethylaminoethyl  
propylphosphonothiolate

Schedule: 1A03

CAS RN: HS code: 2930.90

Key: (67-63-0)-P1A3-MM

Molecular formula: C<sub>10</sub>H<sub>24</sub>NO<sub>2</sub>PS

CAS Index Name: Phosphonothioic acid, propyl-, S-[2-(dimethylamino)ethyl] O-(1-methylethyl) ester

**IUPAC name:** Isopropyl S-2-dimethylaminoethyl  
propylphosphonothioate

Synonyms: Phosphonothioic acid, propyl-, S-[2-(dimethylamino)ethyl] O-1-methylethyl ester  
O-Isopropyl S-2-dimethylaminoethyl propylphosphonothiolate

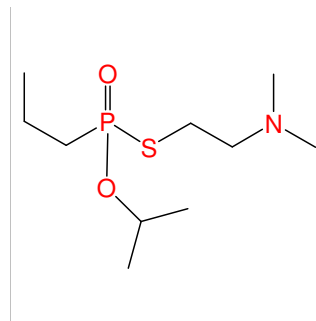

**Chemical name:** Isopropyl S-2-N-methyl-N-propylaminoethyl  
propylphosphonothiolate

Schedule: 1A03

CAS RN: HS code: 2930.90

Key: (67-63-0)-P1A3-MP

Molecular formula: C<sub>12</sub>H<sub>28</sub>NO<sub>2</sub>PS

CAS Index Name:

**IUPAC name:**

Synonyms:

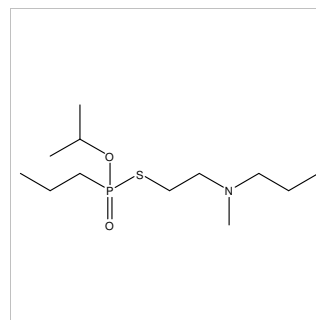

**Chemical name:** Isopropyl S-2-dipropylaminoethyl  
propylphosphonothiolate

Schedule: 1A03

CAS RN: HS code: 2930.90

Key: (67-63-0)-P1A3-PP

Molecular formula: C<sub>14</sub>H<sub>32</sub>NO<sub>2</sub>PS

CAS Index Name: Phosphonothioic acid, propyl-, S-[2-(dipropylamino)ethyl] O-(1-methylethyl) ester

**IUPAC name:** Isopropyl S-2-dipropylaminoethyl  
propylphosphonothioate

Synonyms: Phosphonothioic acid, propyl-, S-[2-(dipropylamino)ethyl] O-1-methylethyl ester  
O-Isopropyl S-2-dipropylaminoethyl propylphosphonothiolate

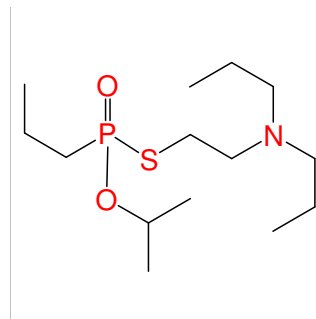

**Chemical name:** Cyclooctyl S-2-diisopropylaminoethyl isopropylphosphonothiolate

Schedule: 1A03

CAS RN: HS code: 2930.90

Key: (696-71-9)-I1A3-II

Molecular formula: C<sub>19</sub>H<sub>40</sub>NO<sub>2</sub>PS

CAS Index Name: Phosphonothioic acid, 1-methylethyl-, S-[2-(bis(1-methylethyl)amino)ethyl] O-cyclooctyl ester

**IUPAC name:** Cyclooctyl S-2-diisopropylaminoethyl isopropylphosphonothioate

Synonyms: O-Cyclooctyl S-2-diisopropylaminoethyl isopropylphosphonothiolate

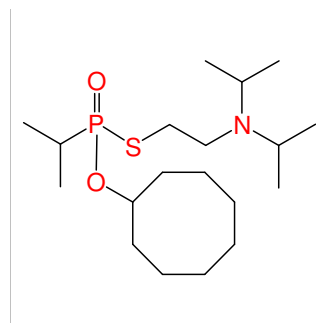

**Chemical name:** Propyl S-2-N-ethyl-N-isopropylaminoethyl ethylphosphonothiolate

Schedule: 1A03

CAS RN: HS code: 2930.90

Key: (71-23-8)-E1A3-EI

Molecular formula: C<sub>12</sub>H<sub>28</sub>NO<sub>2</sub>PS

CAS Index Name: Phosphonothioic acid, ethyl-, S-[2-[[N-ethyl-N-(1-methylethyl)]amino]ethyl]-O-propyl ester

**IUPAC name:**

Synonyms:

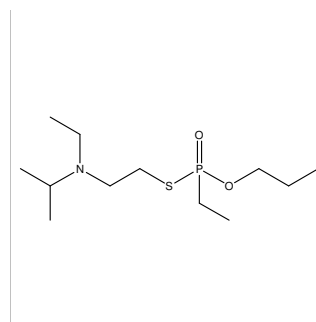

**Chemical name:** Propyl S-2-N-ethyl-N-methylaminoethyl ethylphosphonothiolate

Schedule: 1A03

CAS RN: HS code: 2930.90

Key: (71-23-8)-E1A3-EM

Molecular formula: C<sub>10</sub>H<sub>24</sub>NO<sub>2</sub>PS

CAS Index Name:

**IUPAC name:**

Synonyms:

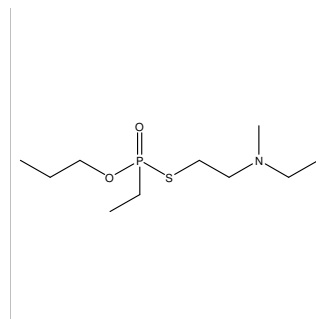

**Chemical name:** Propyl S-2-N-ethyl-N-propylaminoethyl ethylphosphonothiolate

Schedule: 1A03

CAS RN: HS code: 2930.90

Key: (71-23-8)-E1A3-EP

Molecular formula: C<sub>12</sub>H<sub>28</sub>NO<sub>2</sub>PS

CAS Index Name:

**IUPAC name:**

Synonyms:

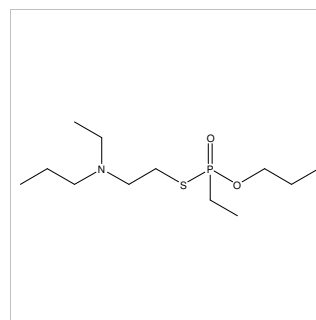



**Chemical name:** Propyl S-2-N-isopropyl-N-methylaminoethyl ethylphosphonothiolate

Schedule: 1A03

CAS RN: HS code: 2930.90

Key: (71-23-8)-E1A3-IM

Molecular formula: C<sub>11</sub>H<sub>26</sub>NO<sub>2</sub>PS

CAS Index Name:

**IUPAC name:**

Synonyms:

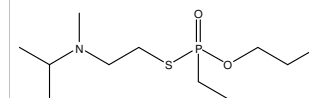

**Chemical name:** Propyl S-2-N-isopropyl-N-propylaminoethyl ethylphosphonothiolate

Schedule: 1A03

CAS RN: HS code: 2930.90

Key: (71-23-8)-E1A3-IP

Molecular formula: C<sub>13</sub>H<sub>30</sub>NO<sub>2</sub>PS

CAS Index Name:

**IUPAC name:**

Synonyms:

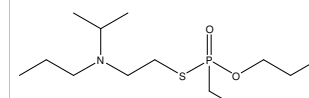

**Chemical name:** Propyl S-2-dimethylaminoethyl ethylphosphonothiolate

Schedule: 1A03

CAS RN: HS code: 2930.90

Key: (71-23-8)-E1A3-MM

Molecular formula: C<sub>9</sub>H<sub>22</sub>NO<sub>2</sub>PS

CAS Index Name: Phosphonothioic acid, ethyl-, S-[2-(dimethylamino)ethyl] O-propyl ester

**IUPAC name:** Propyl S-2-dimethylaminoethyl ethylphosphonothioate

Synonyms: O-Propyl S-2-dimethylaminoethyl ethylphosphonothiolate

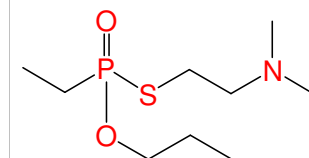

**Chemical name:** Propyl S-2-N-methyl-N-propylaminoethyl ethylphosphonothiolate

Schedule: 1A03

CAS RN: HS code: 2930.90

Key: (71-23-8)-E1A3-MP

Molecular formula: C<sub>11</sub>H<sub>26</sub>NO<sub>2</sub>PS

CAS Index Name:

**IUPAC name:**

Synonyms:

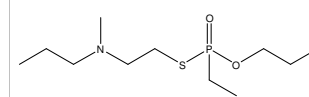

**Chemical name:** Propyl S-2-diethylaminoethyl isopropylphosphonothiolate

Schedule: 1A03

CAS RN: HS code: 2930.90

Key: (71-23-8)-I1A3-EE

Molecular formula: C<sub>12</sub>H<sub>28</sub>NO<sub>2</sub>PS

CAS Index Name: Phosphonothioic acid, 1-methylethyl-, S-[2-(diethylamino)ethyl] O-propyl ester

**IUPAC name:** Propyl S-2-diethylaminoethyl isopropylphosphonothioate

Synonyms: O-Propyl S-2-diethylaminoethyl isopropylphosphonothiolate

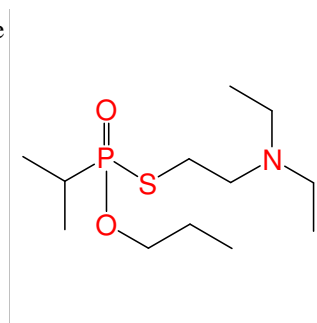

**Chemical name:** Propyl S-2-N-ethyl-N-isopropylaminoethyl isopropylphosphonothiolate

Schedule: 1A03

CAS RN: HS code: 2930.90

Key: (71-23-8)-I1A3-EI

Molecular formula: C<sub>13</sub>H<sub>30</sub>NO<sub>2</sub>PS

CAS Index Name:

**IUPAC name:**

Synonyms:

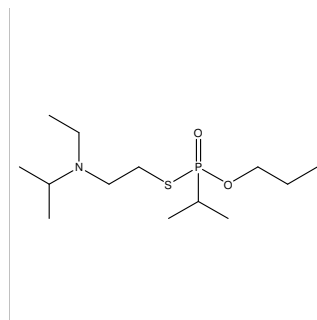

**Chemical name:** Propyl S-2-N-ethyl-N-methylaminoethyl isopropylphosphonothiolate

Schedule: 1A03

CAS RN: HS code: 2930.90

Key: (71-23-8)-I1A3-EM

Molecular formula: C<sub>11</sub>H<sub>26</sub>NO<sub>2</sub>PS

CAS Index Name:

**IUPAC name:**

Synonyms:

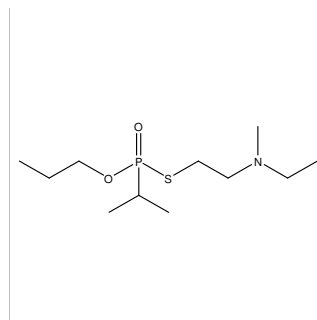

**Chemical name:** Propyl S-2-N-ethyl-N-propylaminoethyl isopropylphosphonothiolate

Schedule: 1A03

CAS RN: HS code: 2930.90

Key: (71-23-8)-I1A3-EP

Molecular formula: C<sub>13</sub>H<sub>30</sub>NO<sub>2</sub>PS

CAS Index Name:

**IUPAC name:**

Synonyms:

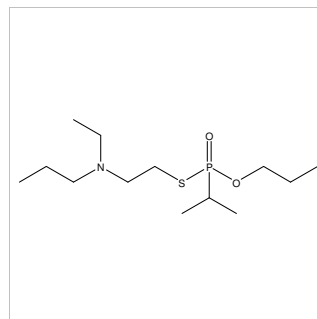

**Chemical name:** Propyl S-2-diisopropylaminoethyl  
isopropylphosphonothiolate

Schedule: 1A03

CAS RN: HS code: 2930.90

Key: (71-23-8)-I1A3-II

Molecular formula: C<sub>14</sub>H<sub>32</sub>NO<sub>2</sub>PS

CAS Index Name: Phosphonothioic acid, 1-methylethyl-, S-[2-(bis(1-methylethyl)amino)ethyl] O-propyl ester

**IUPAC name:** Propyl S-2-diisopropylaminoethyl  
isopropylphosphonothioate

Synonyms: O-Propyl S-2-diisopropylaminoethyl isopropylphosphonothiolate

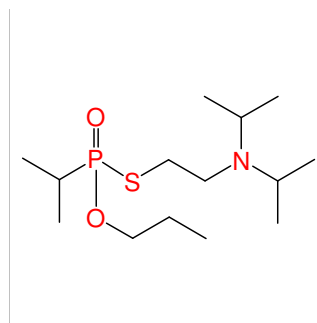

**Chemical name:** Propyl S-2-N-isopropyl-N-methylaminoethyl  
isopropylphosphonothiolate

Schedule: 1A03

CAS RN: HS code: 2930.90

Key: (71-23-8)-I1A3-IM

Molecular formula: C<sub>12</sub>H<sub>28</sub>NO<sub>2</sub>PS

CAS Index Name:

**IUPAC name:**

Synonyms:

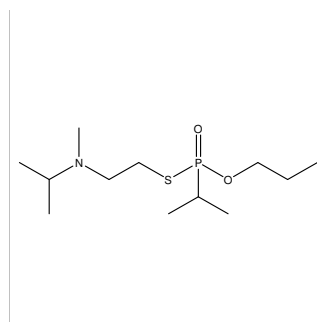

**Chemical name:** Propyl S-2-N-isopropyl-N-propylaminoethyl  
isopropylphosphonothiolate

Schedule: 1A03

CAS RN: HS code: 2930.90

Key: (71-23-8)-I1A3-IP

Molecular formula: C<sub>14</sub>H<sub>32</sub>NO<sub>2</sub>PS

CAS Index Name:

**IUPAC name:**

Synonyms:

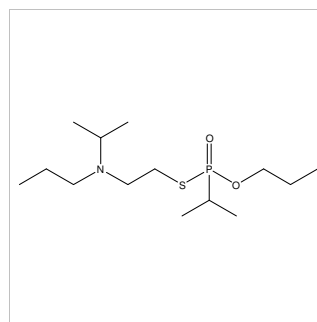

**Chemical name:** Propyl S-2-N-methyl-N-propylaminoethyl  
isopropylphosphonothiolate

Schedule: 1A03

CAS RN: HS code: 2930.90

Key: (71-23-8)-I1A3-MP

Molecular formula: C<sub>12</sub>H<sub>28</sub>NO<sub>2</sub>PS

CAS Index Name:

**IUPAC name:**

Synonyms:

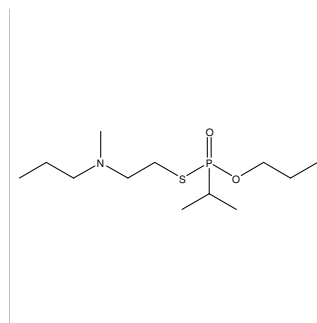

**Chemical name:** Propyl S-2-dipropylaminoethyl  
isopropylphosphonothiolate

Schedule: 1A03

CAS RN: HS code: 2930.90

Key: (71-23-8)-I1A3-PP

Molecular formula: C<sub>14</sub>H<sub>32</sub>NO<sub>2</sub>PS

CAS Index Name: Phosphonothioic acid, 1-methylethyl-, S-[2-(dipropylamino)ethyl] O-propyl ester

**IUPAC name:** Propyl S-2-dipropylaminoethyl  
isopropylphosphonothioate

Synonyms: O-Propyl S-2-dipropylaminoethyl isopropylphosphonothiolate

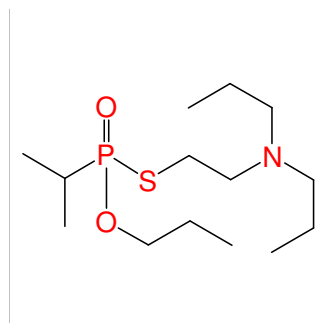

**Chemical name:** Propyl S-2-diethylaminoethyl methylphosphonothiolate

Schedule: 1A03

CAS RN: HS code: 2930.90

Key: (71-23-8)-M1A3-EE

Molecular formula: C<sub>10</sub>H<sub>24</sub>NO<sub>2</sub>PS

CAS Index Name: Phosphonothioic acid, methyl-, S-[2-(diethylamino)ethyl] O-propyl ester

**IUPAC name:** Propyl S-2-diethylaminoethyl methylphosphonothioate

Synonyms: O-Propyl S-2-diethylaminoethyl methylphosphonothiolate

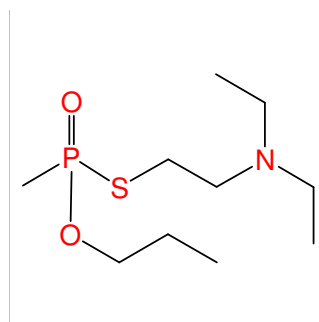

**Chemical name:** Propyl S-2-N-ethyl-N-isopropylaminoethyl  
methylphosphonothiolate

Schedule: 1A03

CAS RN: HS code: 2930.90

Key: (71-23-8)-M1A3-EI

Molecular formula: C<sub>11</sub>H<sub>26</sub>NO<sub>2</sub>PS

CAS Index Name:

**IUPAC name:**

Synonyms:

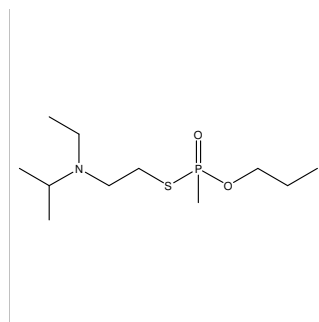

**Chemical name:** Propyl S-2-N-ethyl-N-methylaminoethyl  
methylphosphonothiolate

Schedule: 1A03

CAS RN: HS code: 2930.90

Key: (71-23-8)-M1A3-EM

Molecular formula: C<sub>9</sub>H<sub>22</sub>NO<sub>2</sub>PS

CAS Index Name:

**IUPAC name:**

Synonyms:

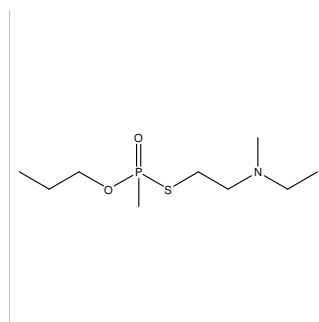

**Chemical name:** Propyl S-2-N-ethyl-N-propylaminoethyl methylphosphonothiolate

Schedule: 1A03

CAS RN: HS code: 2930.90

Key: (71-23-8)-M1A3-EP

Molecular formula: C<sub>11</sub>H<sub>26</sub>NO<sub>2</sub>PS

CAS Index Name:

**IUPAC name:**

Synonyms:

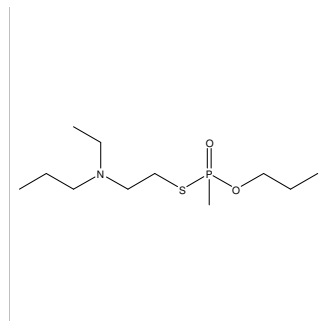

**Chemical name:** Propyl S-2-N-isopropyl-N-methylaminoethyl methylphosphonothiolate

Schedule: 1A03

CAS RN: HS code: 2930.90

Key: (71-23-8)-M1A3-IM

Molecular formula: C<sub>10</sub>H<sub>24</sub>NO<sub>2</sub>PS

CAS Index Name:

**IUPAC name:**

Synonyms:

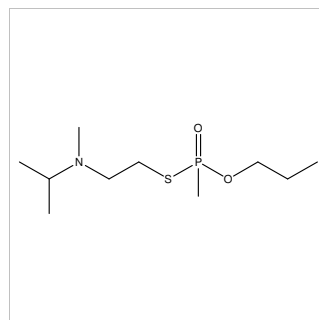

**Chemical name:** Propyl S-2-N-isopropyl-N-propylaminoethyl methylphosphonothiolate

Schedule: 1A03

CAS RN: HS code: 2930.90

Key: (71-23-8)-M1A3-IP

Molecular formula: C<sub>12</sub>H<sub>28</sub>NO<sub>2</sub>PS

CAS Index Name:

**IUPAC name:**

Synonyms:

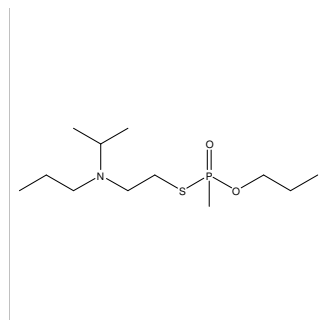

**Chemical name:** Propyl S-2-N-methyl-N-propylaminoethyl methylphosphonothiolate

Schedule: 1A03

CAS RN: HS code: 2930.90

Key: (71-23-8)-M1A3-MP

Molecular formula: C<sub>10</sub>H<sub>24</sub>NO<sub>2</sub>PS

CAS Index Name:

**IUPAC name:**

Synonyms:

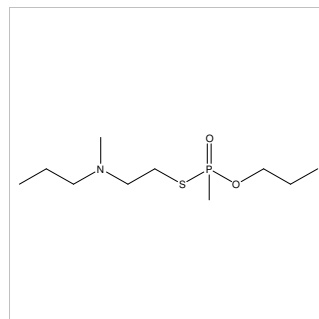

**Chemical name:** Propyl S-2-N-ethyl-N-isopropylaminoethyl  
propylphosphonothiolate

Schedule: 1A03

CAS RN: HS code: 2930.90

Key: (71-23-8)-P1A3-EI

Molecular formula: C<sub>13</sub>H<sub>30</sub>NO<sub>2</sub>PS

CAS Index Name:

**IUPAC name:**

Synonyms:

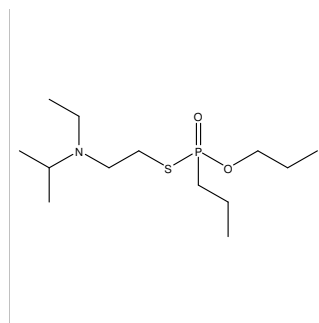

**Chemical name:** Propyl S-2-N-ethyl-N-methylaminoethyl  
propylphosphonothiolate

Schedule: 1A03

CAS RN: HS code: 2930.90

Key: (71-23-8)-P1A3-EM

Molecular formula: C<sub>11</sub>H<sub>26</sub>NO<sub>2</sub>PS

CAS Index Name:

**IUPAC name:**

Synonyms:

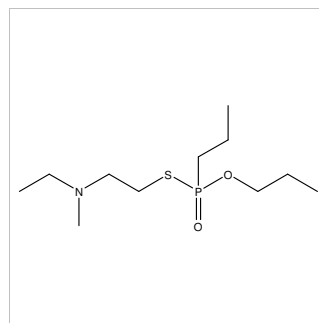

**Chemical name:** Propyl S-2-N-ethyl-N-propylaminoethyl  
propylphosphonothiolate

Schedule: 1A03

CAS RN: HS code: 2930.90

Key: (71-23-8)-P1A3-EP

Molecular formula: C<sub>13</sub>H<sub>30</sub>NO<sub>2</sub>PS

CAS Index Name:

**IUPAC name:**

Synonyms:

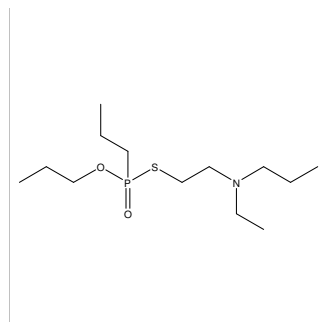

**Chemical name:** Propyl S-2-N-isopropyl-N-methylaminoethyl  
propylphosphonothiolate

Schedule: 1A03

CAS RN: HS code: 2930.90

Key: (71-23-8)-P1A3-IM

Molecular formula: C<sub>12</sub>H<sub>28</sub>NO<sub>2</sub>PS

CAS Index Name:

**IUPAC name:**

Synonyms:

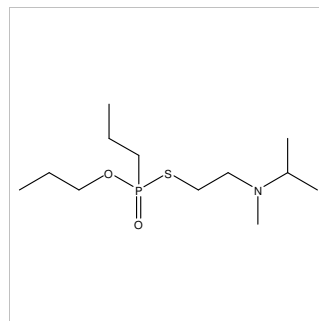

**Chemical name:** Propyl S-2-N-isopropyl-N-propylaminoethyl  
propylphosphonothiolate

Schedule: 1A03

CAS RN: HS code: 2930.90

Key: (71-23-8)-P1A3-IP

Molecular formula: C<sub>14</sub>H<sub>32</sub>NO<sub>2</sub>PS

CAS Index Name:

**IUPAC name:**

Synonyms:

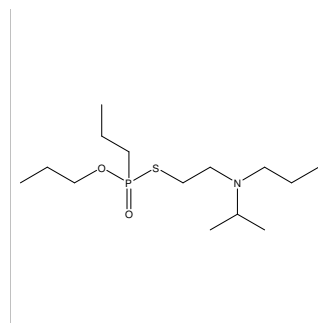

**Chemical name:** O-Propyl S-2-N-methyl-N-propylaminoethyl  
propylphosphonothiolate

Schedule: 1A03

CAS RN: HS code: 2930.90

Key: (71-23-8)-P1A3-MP

Molecular formula: C<sub>12</sub>H<sub>28</sub>NO<sub>2</sub>PS

CAS Index Name:

**IUPAC name:**

Synonyms:

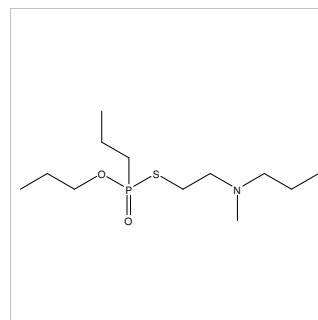

**Chemical name:** Butyl S-2-N-ethyl-N-isopropylaminoethyl  
ethylphosphonothiolate

Schedule: 1A03

CAS RN: HS code: 2930.90

Key: (71-36-3)-E1A3-EI

Molecular formula: C<sub>13</sub>H<sub>30</sub>NO<sub>2</sub>PS

CAS Index Name:

**IUPAC name:**

Synonyms:

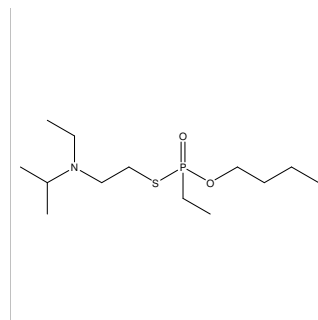

**Chemical name:** Butyl S-2-N-ethyl-N-methylaminoethyl  
ethylphosphonothiolate

Schedule: 1A03

CAS RN: HS code: 2930.90

Key: (71-36-3)-E1A3-EM

Molecular formula: C<sub>11</sub>H<sub>26</sub>NO<sub>2</sub>PS

CAS Index Name:

**IUPAC name:**

Synonyms:

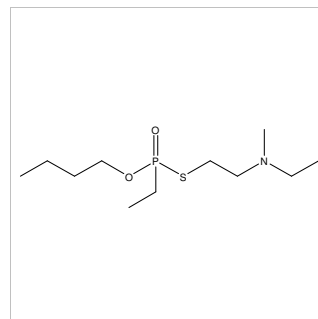

**Chemical name:** Butyl S-2-N-ethyl-N-propylaminoethyl  
ethylphosphonothiolate

Schedule: 1A03

CAS RN: HS code: 2930.90

Key: (71-36-3)-E1A3-EP

Molecular formula: C<sub>13</sub>H<sub>30</sub>NO<sub>2</sub>PS

CAS Index Name:

**IUPAC name:**

Synonyms:

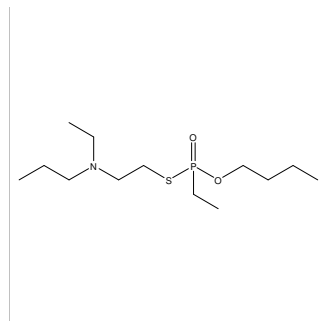

**Chemical name:** Butyl S-2-N-methyl-N-isopropylaminoethyl  
ethylphosphonothiolate

Schedule: 1A03

CAS RN: HS code: 2930.90

Key: (71-36-3)-E1A3-IM

Molecular formula: C<sub>12</sub>H<sub>28</sub>NO<sub>2</sub>PS

CAS Index Name:

**IUPAC name:**

Synonyms:

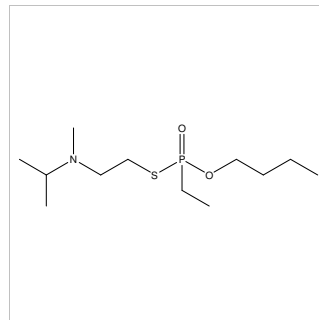

**Chemical name:** Butyl S-2-N-isopropyl-N-propylaminoethyl  
ethylphosphonothiolate

Schedule: 1A03

CAS RN: HS code: 2930.90

Key: (71-36-3)-E1A3-IP

Molecular formula: C<sub>14</sub>H<sub>32</sub>NO<sub>2</sub>PS

CAS Index Name:

**IUPAC name:**

Synonyms:

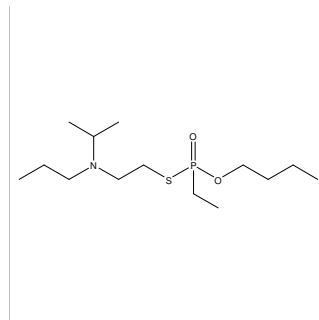

**Chemical name:** Butyl S-2-N-methyl-N-propylaminoethyl  
ethylphosphonothiolate

Schedule: 1A03

CAS RN: HS code: 2930.90

Key: (71-36-3)-E1A3-MP

Molecular formula: C<sub>12</sub>H<sub>28</sub>NO<sub>2</sub>PS

CAS Index Name:

**IUPAC name:**

Synonyms:

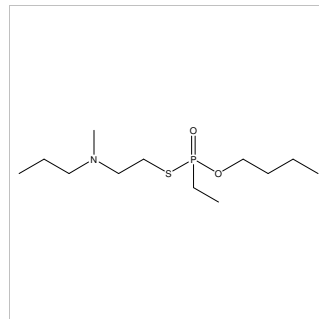



**Chemical name:** Butyl S-2-N-ethyl-N-isopropylaminoethyl  
isopropylphosphonothiolate

Schedule: 1A03

CAS RN: HS code: 2930.90

Key: (71-36-3)-I1A3-EI

Molecular formula: C<sub>14</sub>H<sub>32</sub>NO<sub>2</sub>PS

CAS Index Name:

**IUPAC name:**

Synonyms:

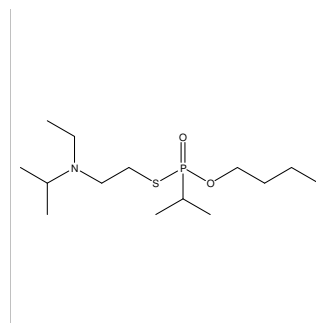

**Chemical name:** Butyl S-2-N-ethyl-N-methylaminoethyl  
isopropylphosphonothiolate

Schedule: 1A03

CAS RN: HS code: 2930.90

Key: (71-36-3)-I1A3-EM

Molecular formula: C<sub>12</sub>H<sub>28</sub>NO<sub>2</sub>PS

CAS Index Name:

**IUPAC name:**

Synonyms:

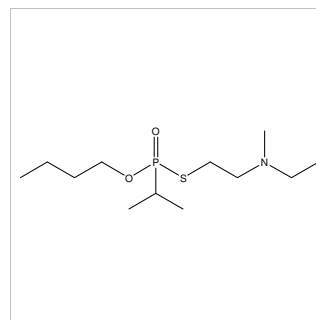

**Chemical name:** Butyl S-2-N-ethyl-N-propylaminoethyl  
isopropylphosphonothiolate

Schedule: 1A03

CAS RN: HS code: 2930.90

Key: (71-36-3)-I1A3-EP

Molecular formula: C<sub>14</sub>H<sub>32</sub>NO<sub>2</sub>PS

CAS Index Name: Phosphonothioic acid, 1-methylethyl-, S-[2-[[N-ethyl-N-propyl]amino]ethyl]-O-butyl ester

**IUPAC name:**

Synonyms:

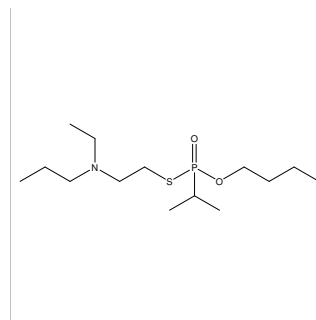

**Chemical name:** Butyl S-2-N-isopropyl-N-methylaminoethyl  
isopropylphosphonothiolate

Schedule: 1A03

CAS RN: HS code: 2930.90

Key: (71-36-3)-I1A3-IM

Molecular formula: C<sub>13</sub>H<sub>30</sub>NO<sub>2</sub>PS

CAS Index Name:

**IUPAC name:**

Synonyms:

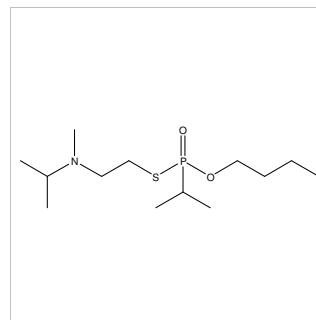

**Chemical name:** Butyl S-2-N-isopropyl-N-propylaminoethyl isopropylphosphonothiolate

Schedule: 1A03

CAS RN: HS code: 2930.90

Key: (71-36-3)-I1A3-IP

Molecular formula: C<sub>15</sub>H<sub>34</sub>NO<sub>2</sub>PS

CAS Index Name:

**IUPAC name:**

Synonyms:

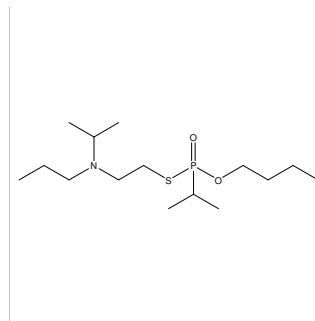

**Chemical name:** Butyl S-2-dimethylaminoethyl isopropylphosphonothiolate

Schedule: 1A03

CAS RN: HS code: 2930.90

Key: (71-36-3)-I1A3-MM

Molecular formula: C<sub>11</sub>H<sub>26</sub>NO<sub>2</sub>PS

CAS Index Name: Phosphonothioic acid, 1-methylethyl-, S-[2-(dimethylamino)ethyl] O-butyl ester

**IUPAC name:** Butyl S-2-dimethylaminoethyl isopropylphosphonothioate

Synonyms: O-Butyl S-2-dimethylaminoethyl isopropylphosphonothiolate

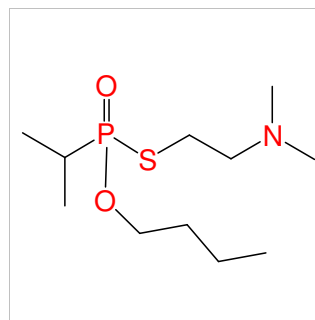

**Chemical name:** Butyl S-2-N-methyl-N-propylaminoethyl isopropylphosphonothiolate

Schedule: 1A03

CAS RN: HS code: 2930.90

Key: (71-36-3)-I1A3-MP

Molecular formula: C<sub>13</sub>H<sub>30</sub>NO<sub>2</sub>PS

CAS Index Name:

**IUPAC name:**

Synonyms:

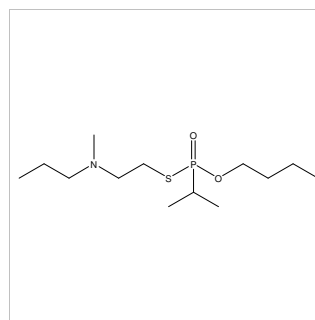

**Chemical name:** Butyl S-2-dipropylaminoethyl isopropylphosphonothiolate

Schedule: 1A03

CAS RN: HS code: 2930.90

Key: (71-36-3)-I1A3-PP

Molecular formula: C<sub>15</sub>H<sub>34</sub>NO<sub>2</sub>PS

CAS Index Name: Phosphonothioic acid, 1-methylethyl-, S-[2-(dipropylamino)ethyl] O-butyl ester

**IUPAC name:** Butyl S-2-dipropylaminoethyl isopropylphosphonothioate

Synonyms: O-Butyl S-2-dipropylaminoethyl isopropylphosphonothiolate

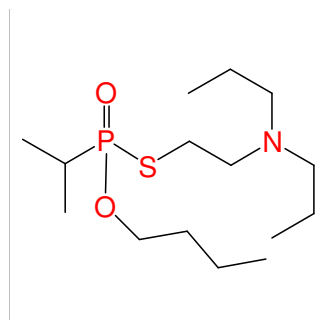

**Chemical name:** Butyl S-2-N-ethyl-N-isopropylaminoethyl methylphosphonothiolate

Schedule: 1A03

CAS RN: HS code: 2930.90

Key: (71-36-3)-M1A3-EI

Molecular formula: C<sub>12</sub>H<sub>28</sub>NO<sub>2</sub>PS

CAS Index Name:

**IUPAC name:**

Synonyms:

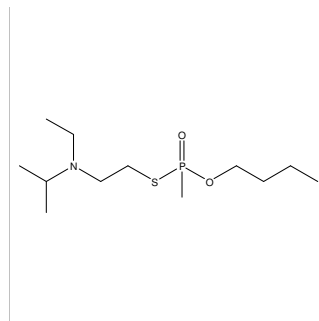

**Chemical name:** Butyl S-2-N-ethyl-N-methylaminoethyl methylphosphonothiolate

Schedule: 1A03

CAS RN: HS code: 2930.90

Key: (71-36-3)-M1A3-EM

Molecular formula: C<sub>10</sub>H<sub>24</sub>NO<sub>2</sub>PS

CAS Index Name:

**IUPAC name:**

Synonyms:

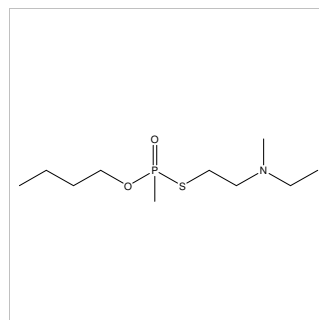

**Chemical name:** Butyl S-2-N-ethyl-N-propylaminoethyl methylphosphonothiolate

Schedule: 1A03

CAS RN: HS code: 2930.90

Key: (71-36-3)-M1A3-EP

Molecular formula: C<sub>12</sub>H<sub>28</sub>NO<sub>2</sub>PS

CAS Index Name:

**IUPAC name:**

Synonyms:

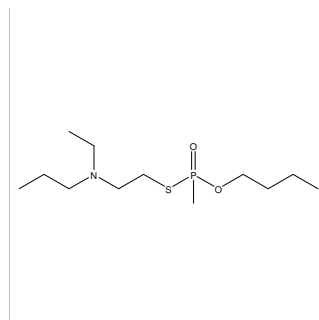

**Chemical name:** Butyl S-2-N-isopropyl-N-methylaminoethyl methylphosphonothiolate

Schedule: 1A03

CAS RN: HS code: 2930.90

Key: (71-36-3)-M1A3-IM

Molecular formula: C<sub>11</sub>H<sub>26</sub>NO<sub>2</sub>PS

CAS Index Name:

**IUPAC name:**

Synonyms:

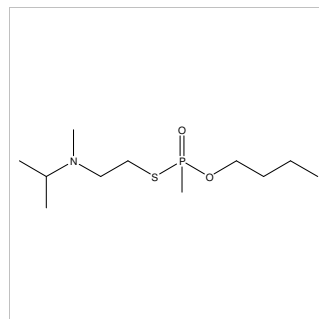

**Chemical name:** Butyl S-2-N-isopropyl-N-propylaminoethyl methylphosphonothiolate

Schedule: 1A03

CAS RN: HS code: 2930.90

Key: (71-36-3)-M1A3-IP

Molecular formula: C<sub>13</sub>H<sub>30</sub>NO<sub>2</sub>PS

CAS Index Name:

**IUPAC name:**

Synonyms:

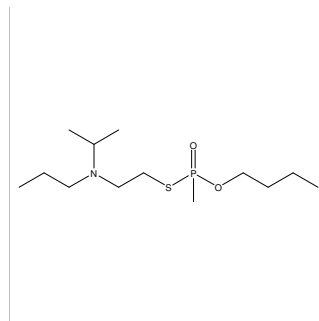

**Chemical name:** Butyl S-2-N-methyl-N-propylaminoethyl methylphosphonothiolate

Schedule: 1A03

CAS RN: HS code: 2930.90

Key: (71-36-3)-M1A3-MP

Molecular formula: C<sub>11</sub>H<sub>26</sub>NO<sub>2</sub>PS

CAS Index Name:

**IUPAC name:**

Synonyms:

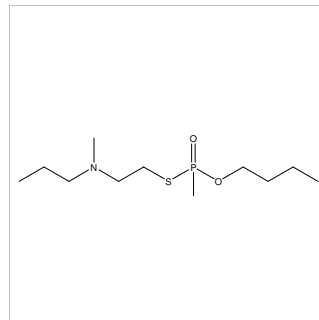

**Chemical name:** Butyl S-2-N-ethyl-N-isopropylaminoethyl propylphosphonothiolate

Schedule: 1A03

CAS RN: HS code: 2930.90

Key: (71-36-3)-P1A3-EI

Molecular formula: C<sub>14</sub>H<sub>32</sub>NO<sub>2</sub>PS

CAS Index Name:

**IUPAC name:**

Synonyms:

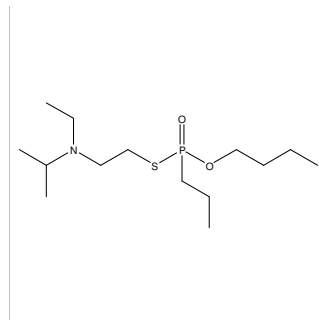

**Chemical name:** Butyl S-2-N-ethyl-N-methylaminoethyl propylphosphonothiolate

Schedule: 1A03

CAS RN: HS code: 2930.90

Key: (71-36-3)-P1A3-EM

Molecular formula: C<sub>12</sub>H<sub>28</sub>NO<sub>2</sub>PS

CAS Index Name:

**IUPAC name:**

Synonyms:

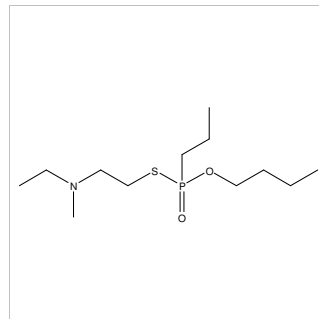

**Chemical name:** Butyl S-2-N-ethyl-N-propylaminoethyl propylphosphonothiolate

Schedule: 1A03

CAS RN: HS code: 2930.90

Key: (71-36-3)-P1A3-EP

Molecular formula: C<sub>14</sub>H<sub>32</sub>NO<sub>2</sub>PS

CAS Index Name:

**IUPAC name:**

Synonyms:

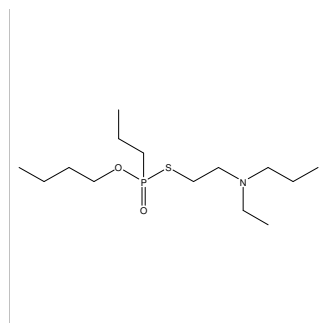

**Chemical name:** Butyl S-2-N-isopropyl-N-methylaminoethyl propylphosphonothiolate

Schedule: 1A03

CAS RN: HS code: 2930.90

Key: (71-36-3)-P1A3-IM

Molecular formula: C<sub>13</sub>H<sub>30</sub>NO<sub>2</sub>PS

CAS Index Name:

**IUPAC name:**

Synonyms:

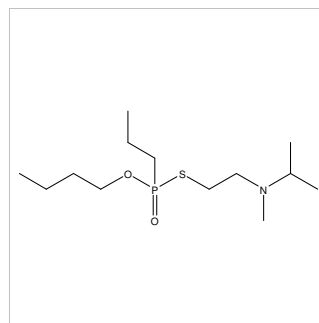

**Chemical name:** Butyl S-2-N-isopropyl-N-propylaminoethyl propylphosphonothiolate

Schedule: 1A03

CAS RN: HS code: 2930.90

Key: (71-36-3)-P1A3-IP

Molecular formula: C<sub>15</sub>H<sub>34</sub>NO<sub>2</sub>PS

CAS Index Name:

**IUPAC name:**

Synonyms:

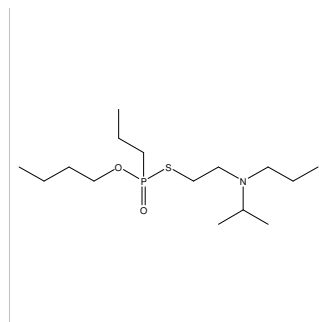

**Chemical name:** Butyl S-2-dimethylaminoethyl propylphosphonothiolate

Schedule: 1A03

CAS RN: HS code: 2930.90

Key: (71-36-3)-P1A3-MM

Molecular formula: C<sub>11</sub>H<sub>26</sub>NO<sub>2</sub>PS

CAS Index Name: Phosphonothioic acid, propyl-, S-[2-(dimethylamino)ethyl] O-butyl ester

**IUPAC name:** Butyl S-2-dimethylaminoethyl propylphosphonothioate

Synonyms: O-Butyl S-2-dimethylaminoethyl propylphosphonothiolate

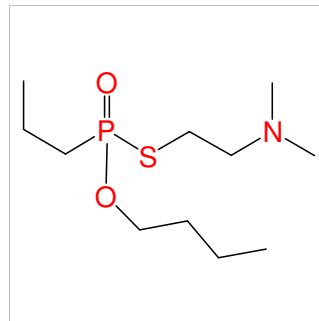

**Chemical name:** Butyl S-2-N-methyl-N-propylaminoethyl propylphosphonothiolate

Schedule: 1A03

CAS RN: HS code: 2930.90

Key: (71-36-3)-P1A3-MP

Molecular formula: C<sub>13</sub>H<sub>30</sub>NO<sub>2</sub>PS

CAS Index Name:

**IUPAC name:**

Synonyms:

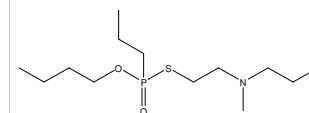

**Chemical name:** Butyl S-2-dipropylaminoethyl propylphosphonothiolate

Schedule: 1A03

CAS RN: HS code: 2930.90

Key: (71-36-3)-P1A3-PP

Molecular formula: C<sub>15</sub>H<sub>34</sub>NO<sub>2</sub>PS

CAS Index Name: Phosphonothioic acid, propyl-, S-[2-(dipropylamino)ethyl] O-butyl ester

**IUPAC name:** Butyl S-2-dipropylaminoethyl propylphosphonothioate

Synonyms: O-Butyl S-2-dipropylaminoethyl propylphosphonothiolate

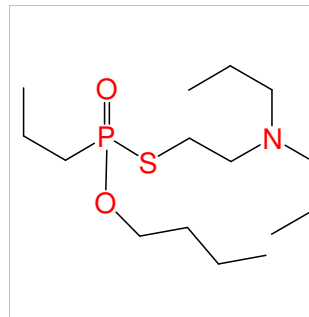

**Chemical name:** Pentyl S-2-dipropylaminoethyl propylphosphonothiolate

Schedule: 1A03

CAS RN: HS code: 2930.90

Key: (71-41-0)-P1A3-PP

Molecular formula: C<sub>16</sub>H<sub>36</sub>NO<sub>2</sub>PS

CAS Index Name:

**IUPAC name:**

Synonyms:

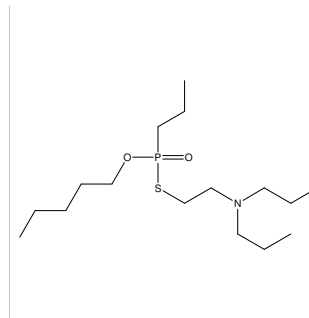

**Chemical name:** tert-Butyl S-2-diisopropylaminoethyl isopropylphosphonothiolate

Schedule: 1A03

CAS RN: HS code: 2930.90

Key: (75-65-0)-I1A3-II

Molecular formula: C<sub>15</sub>H<sub>34</sub>NO<sub>2</sub>PS

CAS Index Name: Phosphonothioic acid, 1-methylethyl-, S-[2-(bis(1-methylethyl)amino)ethyl] O-(1,1-dimethylethyl) ester

**IUPAC name:** tert-Butyl S-2-diisopropylaminoethyl isopropylphosphonothioate

Synonyms: O-tert-Butyl S-2-diisopropylaminoethyl isopropylphosphonothiolate

O-1,1-Dimethylethyl S-2-diisopropylaminoethyl isopropylphosphonothiolate

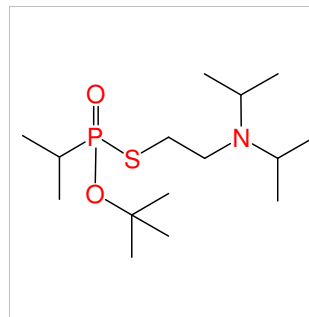

**Chemical name:** tert-Butyl S-2-diisopropylaminoethyl methylphosphonothiolate

Schedule: 1A03

CAS RN: HS code: 2930.90

Key: (75-65-0)-M1A3-II

Molecular formula: C<sub>13</sub>H<sub>30</sub>NO<sub>2</sub>PS

CAS Index Name: Phosphonothioic acid, methyl-, S-[2-(bis(1-methylethyl)amino)ethyl] O-(1,1-dimethylethyl) ester

**IUPAC name:** tert-Butyl S-2-diisopropylaminoethyl methylphosphonothioate

Synonyms: O-tert-Butyl S-2-diisopropylaminoethyl methylphosphonothiolate

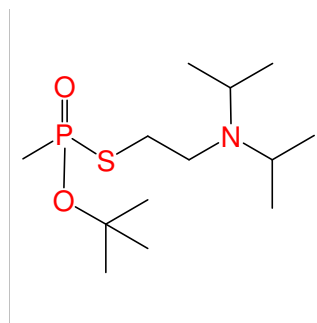

**Chemical name:** tert-Butyl S-2-dimethylaminoethyl methylphosphonothiolate

Schedule: 1A03

CAS RN: HS code: 2930.90

Key: (75-65-0)-M1A3-MM

Molecular formula: C<sub>9</sub>H<sub>22</sub>NO<sub>2</sub>PS

CAS Index Name: Phosphonothioic acid, methyl-, S-[2-(dimethylamino)ethyl] O-(1,1-dimethylethyl) ester

**IUPAC name:** tert-Butyl S-2-dimethylaminoethyl methylphosphonothioate

Synonyms: O-tert-Butyl S-2-dimethylaminoethyl methylphosphonothiolate

1,1-Dimethylethyl S-2-dimethylaminoethyl methylphosphonothiolate

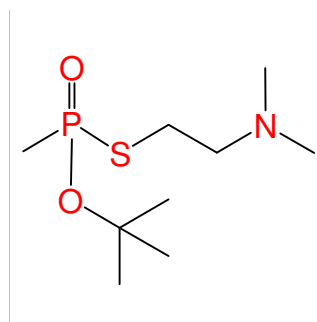

**Chemical name:** tert-Butyl S-2-dipropylaminoethyl methylphosphonothiolate

Schedule: 1A03

CAS RN: HS code: 2930.90

Key: (75-65-0)-M1A3-PP

Molecular formula: C<sub>13</sub>H<sub>30</sub>NO<sub>2</sub>PS

CAS Index Name: Phosphonothioic acid, methyl-, S-[2-(dipropylamino)ethyl] O-(1,1-dimethylethyl) ester

**IUPAC name:** tert-Butyl S-2-dipropylaminoethyl methylphosphonothioate

Synonyms: O-tert-Butyl S-2-dipropylaminoethyl methylphosphonothiolate

O-(1,1-dimethylethyl) S-2-dipropylaminoethyl methylphosphonothiolate

1,1-dimethylethyl S-2-dipropylaminoethyl methylphosphonothiolate

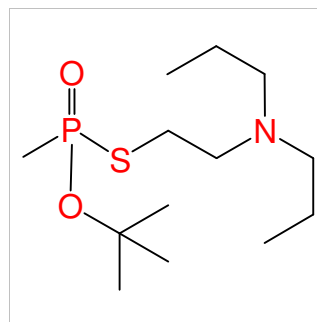

**Chemical name:** 2,2-Dimethylpropyl S-2-dipropylaminoethyl isopropylphosphonothiolate

Schedule: 1A03

CAS RN: HS code: 2930.90

Key: (75-84-3)-I1A3-PP

Molecular formula: C<sub>16</sub>H<sub>36</sub>NO<sub>2</sub>PS

CAS Index Name:

**IUPAC name:**

Synonyms:

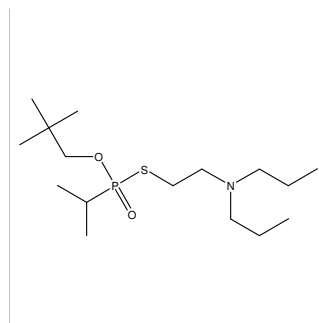

**Chemical name:** 2,2-Dimethylpropyl S-2-diisopropylaminoethyl methylphosphonothiolate (-)

Schedule: 1A03

CAS RN: HS code: 2930.90

Key: (75-84-3)-M1A3-II-(-)

Molecular formula: C<sub>14</sub>H<sub>32</sub>NO<sub>2</sub>PS

CAS Index Name: Phosphonothioic acid, methyl-, S-[2-(bis(1-methylethyl)amino)ethyl] O-(2,2-dimethylpropyl) ester, (-)

**IUPAC name:** 2,2-Dimethylpropyl S-2-diisopropylaminoethyl methylphosphonothioate (-)

Synonyms: O-2,2-Dimethylpropyl S-2-diisopropylaminoethyl methylphosphonothiolate (-)

O-(-)-2,2-Dimethylpropyl S-2-diisopropylaminoethyl methylphosphonothiolate

Neopentyl S-2-diisopropylaminoethyl methylphosphonothiolate (-)

(-)-O-2,2-Dimethylpropyl S-2-diisopropylaminoethyl methylphosphonothiolate

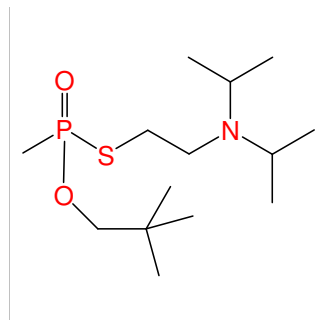

**Chemical name:** 2,2-Dimethylpropyl S-2-dipropylaminoethyl methylphosphonothiolate

Schedule: 1A03

CAS RN: HS code: 2930.90

Key: (75-84-3)-M1A3-PP

Molecular formula: C<sub>14</sub>H<sub>32</sub>NO<sub>2</sub>PS

CAS Index Name: Phosphonothioic acid, methyl-, S-[2-(dipropylamino)ethyl] O-(2,2-dimethylpropyl) ester

**IUPAC name:** 2,2-Dimethylpropyl S-2-dipropylaminoethyl methylphosphonothioate

Synonyms: O-2,2-Dimethylpropyl S-2-dipropylaminoethyl methylphosphonothiolate

Neopentyl S-2-dipropylaminoethyl methylphosphonothiolate

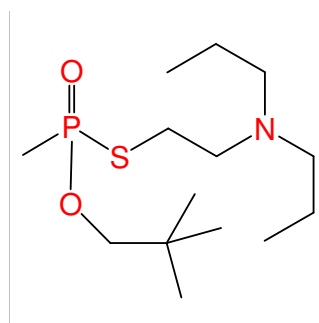



**Chemical name:** 2,2-Dimethylpropyl S-2-dipropylaminoethyl propylphosphonothiolate

Schedule: 1A03

CAS RN: HS code: 2930.90

Key: (75-84-3)-P1A3-PP

Molecular formula: C<sub>16</sub>H<sub>36</sub>NO<sub>2</sub>PS

CAS Index Name:

**IUPAC name:**

Synonyms:

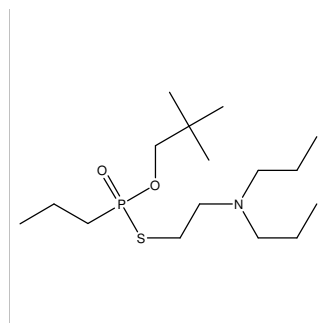

**Chemical name:** 3-Cyclopentylpropyl S-2-diethylaminoethyl methylphosphonothiolate

Schedule: 1A03

CAS RN: HS code: 2930.90

Key: (767-05-5)-M1A3-EE

Molecular formula: C<sub>15</sub>H<sub>32</sub>NO<sub>2</sub>PS

CAS Index Name:

**IUPAC name:**

Synonyms:

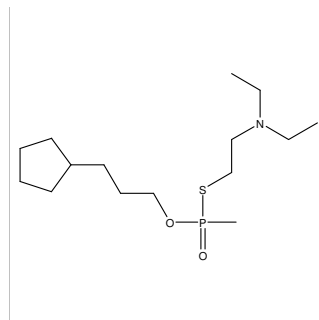

**Chemical name:** Isobutyl S-2-diethylmethylammoniummethyl ethylphosphonothiolate iodide

Schedule: 1A03

CAS RN: HS code: 2930.90

Key: (78-83-1)-E1A3-EEM(I)

Molecular formula: C<sub>13</sub>H<sub>31</sub>INO<sub>2</sub>PS

CAS Index Name: Ethanaminium, N,N-diethyl-N-methyl-2-[(isobutoxyethylphosphinyl)thio]-, iodide

**IUPAC name:** N,N-diethyl-2-[[ethyl(isobutoxy)phosphoryl]thio]-N-methylethanaminium iodide

Synonyms: O-Isobutyl S-2-diethylmethylammoniummethyl ethylphosphonothiolate iodide  
O-Isobutyl S-2-(diethylmethylammonium)ethyl ethylphosphonothiolate iodide  
O-2-Methylpropyl S-2-diethylmethylammoniummethyl ethylphosphonothiolate iodide

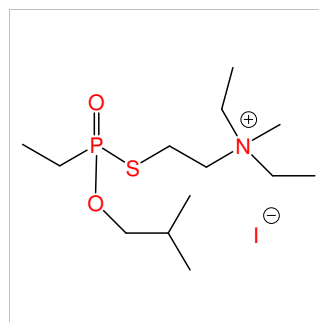

**Chemical name:** Isobutyl S-2-N-ethyl-N-isopropylaminoethyl  
ethylphosphonothiolate

Schedule: 1A03

CAS RN: HS code: 2930.90

Key: (78-83-1)-E1A3-EI

Molecular formula: C<sub>13</sub>H<sub>30</sub>NO<sub>2</sub>PS

CAS Index Name:

**IUPAC name:**

Synonyms:

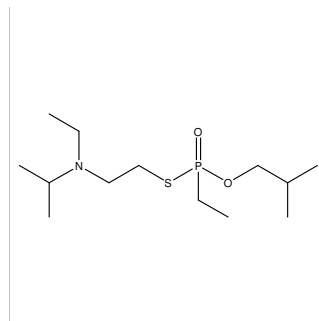

**Chemical name:** Isobutyl S-2 N-ethyl-N-methylaminoethyl  
ethylphosphonothiolate

Schedule: 1A03

CAS RN: HS code: 2930.90

Key: (78-83-1)-E1A3-EM

Molecular formula: C<sub>11</sub>H<sub>26</sub>NO<sub>2</sub>PS

CAS Index Name:

**IUPAC name:**

Synonyms:

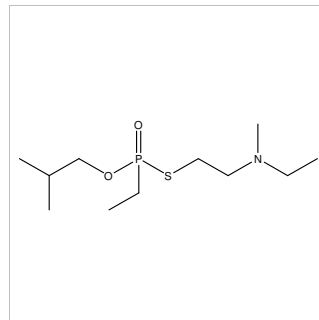

**Chemical name:** Isobutyl S-2-N-ethyl-N-propylaminoethyl  
ethylphosphonothiolate

Schedule: 1A03

CAS RN: HS code: 2930.90

Key: (78-83-1)-E1A3-EP

Molecular formula: C<sub>13</sub>H<sub>30</sub>NO<sub>2</sub>PS

CAS Index Name:

**IUPAC name:**

Synonyms:

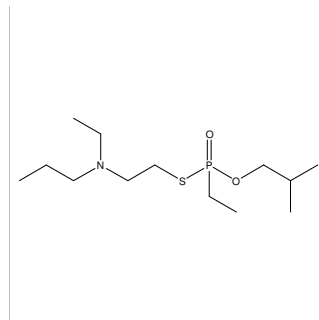

**Chemical name:** Isobutyl S-2-N-methyl-N-isopropylaminoethyl  
ethylphosphonothiolate

Schedule: 1A03

CAS RN: HS code: 2930.90

Key: (78-83-1)-E1A3-IM

Molecular formula: C<sub>12</sub>H<sub>28</sub>NO<sub>2</sub>PS

CAS Index Name:

**IUPAC name:**

Synonyms:

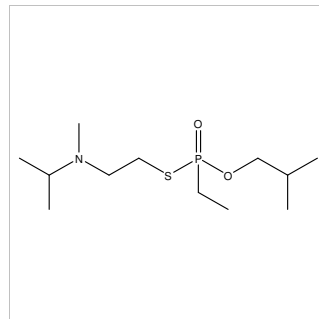

**Chemical name:** Isobutyl S-2-N-isopropyl-N-propylaminoethyl ethylphosphonothiolate

Schedule: 1A03

CAS RN: HS code: 2930.90

Key: (78-83-1)-E1A3-IP

Molecular formula: C<sub>14</sub>H<sub>32</sub>NO<sub>2</sub>PS

CAS Index Name:

**IUPAC name:**

Synonyms:

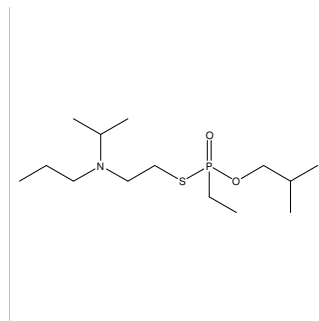

**Chemical name:** Isobutyl S-2-N-methyl-N-propylaminoethyl ethylphosphonothiolate

Schedule: 1A03

CAS RN: HS code: 2930.90

Key: (78-83-1)-E1A3-MP

Molecular formula: C<sub>12</sub>H<sub>28</sub>NO<sub>2</sub>PS

CAS Index Name:

**IUPAC name:**

Synonyms:

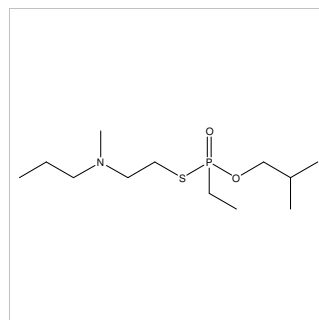

**Chemical name:** Isobutyl S-2-N-ethyl-N-isopropylaminoethyl isopropylphosphonothiolate

Schedule: 1A03

CAS RN: HS code: 2930.90

Key: (78-83-1)-I1A3-EI

Molecular formula: C<sub>14</sub>H<sub>32</sub>NO<sub>2</sub>PS

CAS Index Name:

**IUPAC name:**

Synonyms:

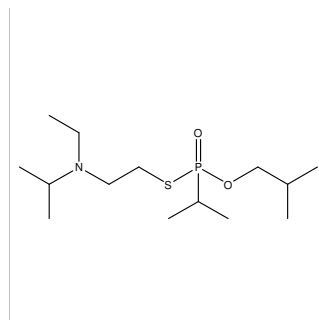

**Chemical name:** Isobutyl S-2-N-ethyl-N-methylaminoethyl isopropylphosphonothiolate

Schedule: 1A03

CAS RN: HS code: 2930.90

Key: (78-83-1)-I1A3-EM

Molecular formula: C<sub>12</sub>H<sub>28</sub>NO<sub>2</sub>PS

CAS Index Name:

**IUPAC name:**

Synonyms:

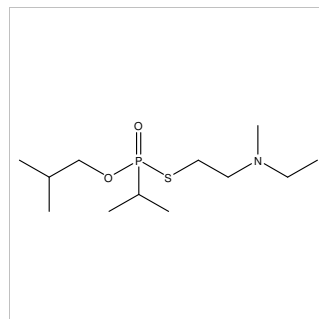

**Chemical name:** Isobutyl S-2-N-ethyl-N-propylaminoethyl isopropylphosphonothiolate

Schedule: 1A03

CAS RN: HS code: 2930.90

Key: (78-83-1)-I1A3-EP

Molecular formula: C<sub>14</sub>H<sub>32</sub>NO<sub>2</sub>PS

CAS Index Name:

**IUPAC name:**

Synonyms:

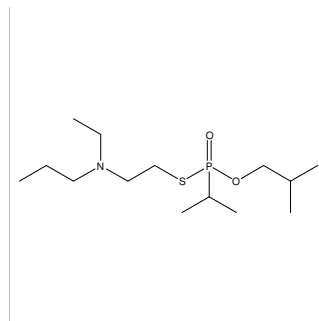

**Chemical name:** Isobutyl S-2-diisopropylaminoethyl isopropylphosphonothiolate

Schedule: 1A03

CAS RN: HS code: 2930.90

Key: (78-83-1)-I1A3-II

Molecular formula: C<sub>15</sub>H<sub>34</sub>NO<sub>2</sub>PS

CAS Index Name: Phosphonothioic acid, 1-methylethyl-, S-[2-(bis(1-methylethyl)amino)ethyl] O-(2-methylpropyl) ester

**IUPAC name:** Isobutyl S-2-diisopropylaminoethyl isopropylphosphonothioate

Synonyms: Phosphonothioic acid, 1-methylethyl-, S-[2-(bis(1-methylethyl)amino)ethyl] O-2-methyl ester

O-Isobutyl S-2-diisopropylaminoethyl isopropylphosphonothiolate

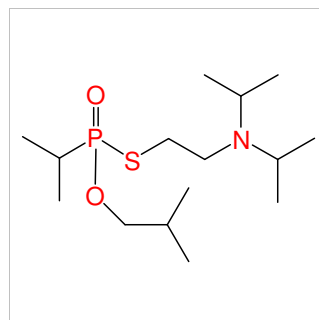

**Chemical name:** Isobutyl S-2-N-isopropyl-N-methylaminoethyl isopropyl phosphonothiolate

Schedule: 1A03

CAS RN: HS code: 2930.90

Key: (78-83-1)-I1A3-IM

Molecular formula: C<sub>13</sub>H<sub>30</sub>NO<sub>2</sub>PS

CAS Index Name:

**IUPAC name:**

Synonyms:

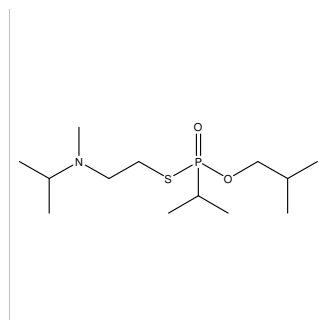

**Chemical name:** Isobutyl S-2-N-isopropyl-N-propylaminoethyl  
isopropylphosphonothiolate

Schedule: 1A03

CAS RN: HS code: 2930.90

Key: (78-83-1)-I1A3-IP

Molecular formula: C<sub>15</sub>H<sub>34</sub>NO<sub>2</sub>PS

CAS Index Name:

**IUPAC name:**

Synonyms:

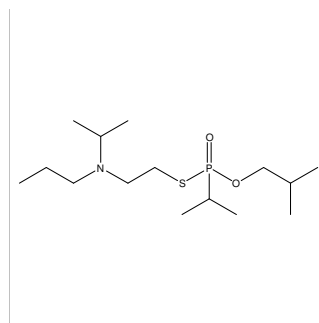

**Chemical name:** Isobutyl S-2-dimethylaminoethyl  
isopropylphosphonothiolate

Schedule: 1A03

CAS RN: HS code: 2930.90

Key: (78-83-1)-I1A3-MM

Molecular formula: C<sub>11</sub>H<sub>26</sub>NO<sub>2</sub>PS

CAS Index Name: Phosphonothioic acid, 1-methylethyl-, S-[2-(dimethylamino)ethyl] O-(2-methylpropyl) ester

**IUPAC name:** Isobutyl S-2-dimethylaminoethyl  
isopropylphosphonothioate

Synonyms: Phosphonothioic acid, 1-methylethyl-, S-[2-(dimethylamino)ethyl] O-2-methylpropyl e:

O-Isobutyl S-2-dimethylaminoethyl isopropylphosphonothiolate

O-2-Methylpropyl S-2-dimethylaminoethyl isopropylphosphonothiolate

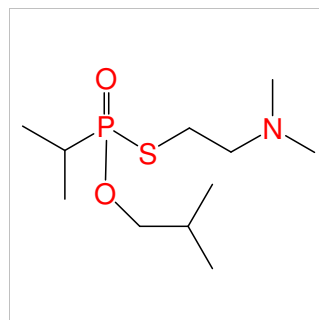

**Chemical name:** Isobutyl S-2-N-methyl-N-propylaminoethyl  
isopropylphosphonothiolate

Schedule: 1A03

CAS RN: HS code: 2930.90

Key: (78-83-1)-I1A3-MP

Molecular formula: C<sub>13</sub>H<sub>30</sub>NO<sub>2</sub>PS

CAS Index Name:

**IUPAC name:**

Synonyms:

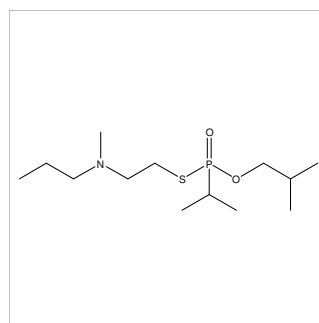

**Chemical name:** Isobutyl S-2-dipropylaminoethyl  
isopropylphosphonothiolate

Schedule: 1A03

CAS RN: HS code: 2930.90

Key: (78-83-1)-I1A3-PP

Molecular formula: C<sub>15</sub>H<sub>34</sub>NO<sub>2</sub>PS

CAS Index Name: Phosphonothioic acid, 1-methylethyl-, S-[2-(dipropylamino)ethyl] O-(2-methylpropyl) ester

**IUPAC name:** Isobutyl S-2-dipropylaminoethyl  
isopropylphosphonothioate

Synonyms: Phosphonothioic acid, 1-methylethyl-, S-[2-(dipropylamino)ethyl] O-2-methylpropyl ester  
O-Isobutyl S-2-dipropylaminoethyl isopropylphosphonothiolate  
O-2-Methylpropyl S-2-dipropylaminoethyl isopropylphosphonothiolate

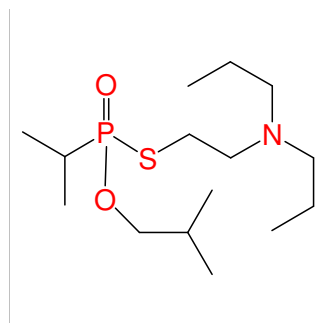

**Chemical name:** Isobutyl S-2-diethylammoniummethyl  
methylphosphonothiolate chloride

Schedule: 1A03

CAS RN: HS code: 2930.90

Key: (78-83-1)-M1A3-EEH(Cl)

Molecular formula: C<sub>11</sub>H<sub>27</sub>ClNO<sub>2</sub>PS

CAS Index Name: Ethanaminium, N,N-diethyl-2-{{methyl(2-methylpropoxy)phosphoryl}thio}-, chloride

**IUPAC name:** N,N-Diethyl-2-{{methyl(2-methylpropoxy)phosphoryl}sulfanyl}ethanaminium

Synonyms: O-Isobutyl S-2-diethylammoniummethyl methylphosphonothiolate chloride  
O-Isobutyl S-2-diethylaminoethyl methylphosphonothiolate hydrochloride  
N,N-Diethyl-2-[isobutoxy(methyl)phosphorylthio]ethanaminium chloride  
Isobutyl S-2-diethylaminoethyl methylphosphonothiolate hydrochloride

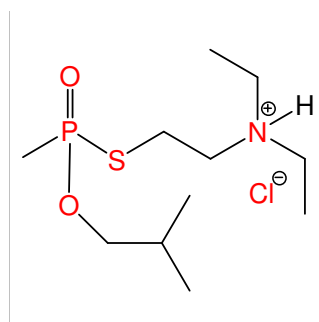

**Chemical name:** Isobutyl S-2-diethylmethylammoniummethyl  
methylphosphonothiolate iodide

Schedule: 1A03

CAS RN: HS code: 2930.90

Key: (78-83-1)-M1A3-EEM(I)

Molecular formula: C<sub>12</sub>H<sub>29</sub>I NO<sub>2</sub>PS

CAS Index Name: Ethanaminium, N,N-diethyl-2-{{methyl(2-methylpropoxy)phosphoryl}thio}-N-methyl-, iodide

**IUPAC name:** N,N-Diethyl-N-methyl-2-{{methyl(2-methylpropoxy)phosphoryl}thio}ethanaminium iodide

Synonyms: O-Isobutyl S-2-diethylmethylammoniummethyl methylphosphonothiolate iodide  
N,N-diethyl-N-methyl-2-{{methyl(2-methylpropoxy)phosphoryl}sulfanyl}ethanaminium iodide

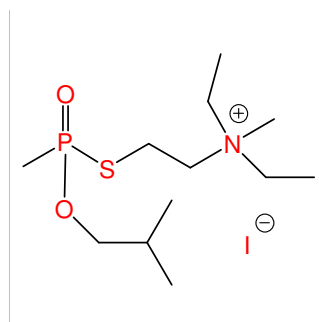

**Chemical name:** Isobutyl S-2-N-ethyl-N-isopropylaminoethyl methylphosphonothiolate

Schedule: 1A03

CAS RN: HS code: 2930.90

Key: (78-83-1)-M1A3-EI

Molecular formula: C<sub>12</sub>H<sub>28</sub>NO<sub>2</sub>PS

CAS Index Name:

**IUPAC name:**

Synonyms:

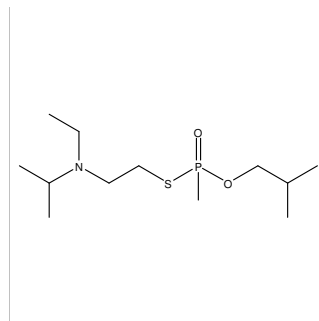

**Chemical name:** Isobutyl S-2-N-ethyl-N-propylaminoethyl methylphosphonothiolate

Schedule: 1A03

CAS RN: HS code: 2930.90

Key: (78-83-1)-M1A3-EP

Molecular formula: C<sub>12</sub>H<sub>28</sub>NO<sub>2</sub>PS

CAS Index Name:

**IUPAC name:**

Synonyms:

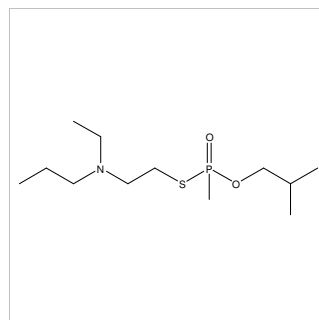

**Chemical name:** Isobutyl S-2-N-isopropyl-N-methylaminoethyl methylphosphonothiolate

Schedule: 1A03

CAS RN: HS code: 2930.90

Key: (78-83-1)-M1A3-IM

Molecular formula: C<sub>11</sub>H<sub>26</sub>NO<sub>2</sub>PS

CAS Index Name:

**IUPAC name:**

Synonyms:

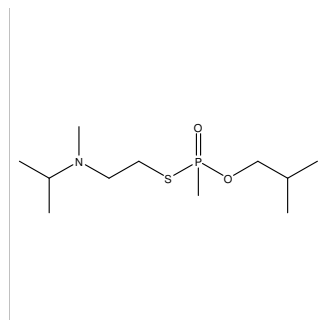

**Chemical name:** Isobutyl S-2-N-isopropyl-N-propylaminoethyl methylphosphonothiolate

Schedule: 1A03

CAS RN: HS code: 2930.90

Key: (78-83-1)-M1A3-IP

Molecular formula: C<sub>13</sub>H<sub>30</sub>NO<sub>2</sub>PS

CAS Index Name:

**IUPAC name:**

Synonyms:

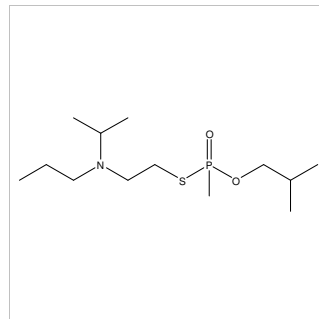

**Chemical name:** Isobutyl S-2-N-methyl-N-propylaminoethyl methylphosphonothiolate

Schedule: 1A03

CAS RN: HS code: 2930.90

Key: (78-83-1)-M1A3-MP

Molecular formula: C<sub>11</sub>H<sub>26</sub>NO<sub>2</sub>PS

CAS Index Name:

**IUPAC name:**

Synonyms:

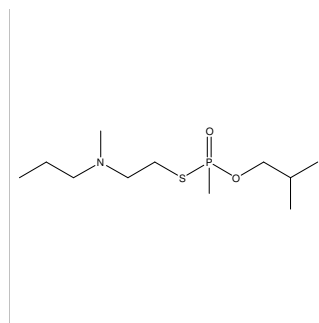

**Chemical name:** Isobutyl S-2-N-ethyl-N-isopropylaminoethyl propylphosphonothiolate

Schedule: 1A03

CAS RN: HS code: 2930.90

Key: (78-83-1)-P1A3-EI

Molecular formula: C<sub>14</sub>H<sub>32</sub>NO<sub>2</sub>PS

CAS Index Name:

**IUPAC name:**

Synonyms:

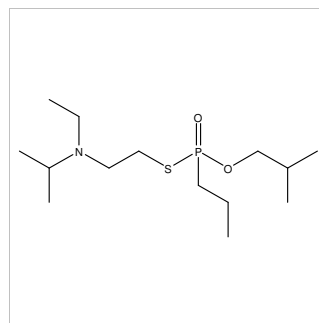

**Chemical name:** Isobutyl S-2-N-ethyl-N-methylaminoethyl propylphosphonothiolate

Schedule: 1A03

CAS RN: HS code: 2930.90

Key: (78-83-1)-P1A3-EM

Molecular formula: C<sub>12</sub>H<sub>28</sub>NO<sub>2</sub>PS

CAS Index Name:

**IUPAC name:**

Synonyms:

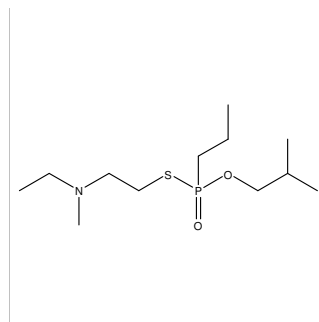

**Chemical name:** Isobutyl S-2-N-ethyl-N-propylaminoethyl propylphosphonothiolate

Schedule: 1A03

CAS RN: HS code: 2930.90

Key: (78-83-1)-P1A3-EP

Molecular formula: C<sub>14</sub>H<sub>32</sub>NO<sub>2</sub>PS

CAS Index Name:

**IUPAC name:**

Synonyms:

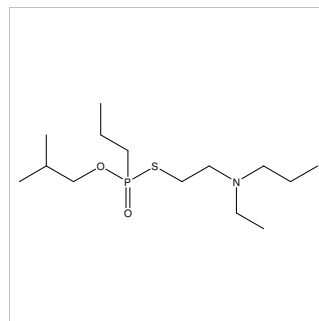



**Chemical name:** Isobutyl S-2-diisopropylaminoethyl propylphosphonothiolate

Schedule: 1A03

CAS RN: HS code: 2930.90

Key: (78-83-1)-P1A3-II

Molecular formula: C<sub>15</sub>H<sub>34</sub>NO<sub>2</sub>PS

CAS Index Name: Phosphonothioic acid, propyl-, S-[2-(bis(1-methylethyl)amino)ethyl] O-(2-methylpropyl) ester

**IUPAC name:** Isobutyl S-2-diisopropylaminoethyl propylphosphonothioate

Synonyms: Phosphonothioic acid, propyl-, S-[2-(bis(1-methylethyl)amino)ethyl] O-2-methylpropyl O-Isobutyl S-2-diisopropylaminoethyl propylphosphonothiolate

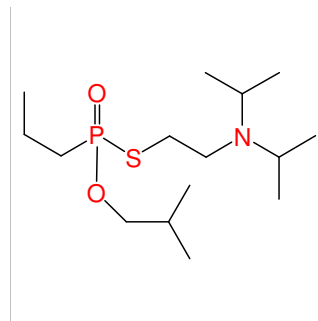

**Chemical name:** Isobutyl S-2-N-isopropyl-N-methylaminoethyl propylphosphonothiolate

Schedule: 1A03

CAS RN: HS code: 2930.90

Key: (78-83-1)-P1A3-IM

Molecular formula: C<sub>13</sub>H<sub>30</sub>NO<sub>2</sub>PS

CAS Index Name:

**IUPAC name:**

Synonyms:

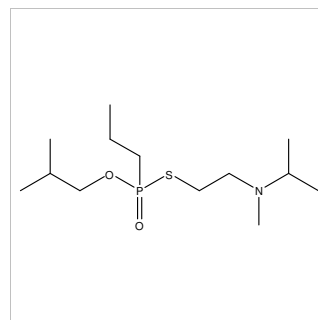

**Chemical name:** Isobutyl S-2-N-isopropyl-N-propylaminoethyl propylphosphonothiolate

Schedule: 1A03

CAS RN: HS code: 2930.90

Key: (78-83-1)-P1A3-IP

Molecular formula: C<sub>15</sub>H<sub>34</sub>NO<sub>2</sub>PS

CAS Index Name:

**IUPAC name:**

Synonyms:

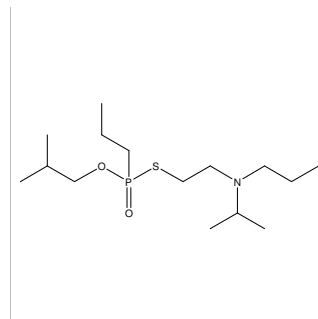

**Chemical name:** Isobutyl S-2-dimethylaminoethyl propylphosphonothiolate

Schedule: 1A03

CAS RN: HS code: 2930.90

Key: (78-83-1)-P1A3-MM

Molecular formula: C<sub>11</sub>H<sub>26</sub>NO<sub>2</sub>PS

CAS Index Name: Phosphonothioic acid, propyl-, S-[2-(dimethylamino)ethyl] O-(2-methylpropyl) ester

**IUPAC name:** Isobutyl S-2-dimethylaminoethyl propylphosphonothioate

Synonyms: O-Isobutyl S-2-dimethylaminoethyl propylphosphonothiolate

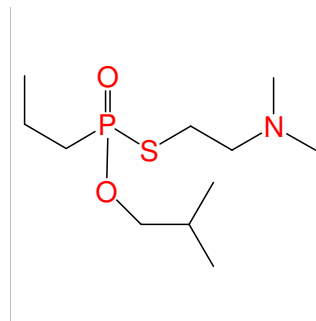

**Chemical name:** Isobutyl S-2-N-methyl-N-propylaminoethyl propylphosphonothiolate

Schedule: 1A03

CAS RN: HS code: 2930.90

Key: (78-83-1)-P1A3-MP

Molecular formula: C<sub>13</sub>H<sub>30</sub>NO<sub>2</sub>PS

CAS Index Name:

**IUPAC name:**

Synonyms:

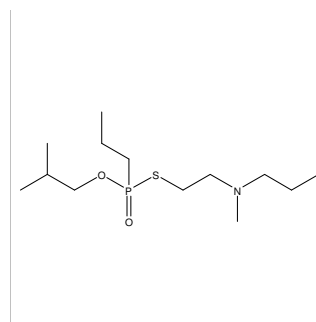

**Chemical name:** Isobutyl S-2-dipropylaminoethyl propylphosphonothiolate

Schedule: 1A03

CAS RN: HS code: 2930.90

Key: (78-83-1)-P1A3-PP

Molecular formula: C<sub>15</sub>H<sub>34</sub>NO<sub>2</sub>PS

CAS Index Name: Phosphonothioic acid, propyl-, S-[2-(dipropylamino)ethyl] O-(2-methylpropyl) ester

**IUPAC name:** Isobutyl S-2-dipropylaminoethyl propylphosphonothioate

Synonyms: Phosphonothioic acid, propyl-, S-[2-(dipropylamino)ethyl] O-2-methylpropyl ester

O-Isobutyl S-2-dipropylaminoethyl propylphosphonothiolate

O-2-Methylpropyl S-2-dipropylaminoethyl propylphosphonothiolate

2-Methylpropyl S-2-dipropylaminoethyl propylphosphonothiolate

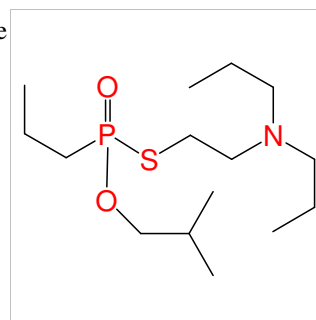

**Chemical name:** sec-Butyl S-2-N-ethyl-N-isopropylaminoethyl ethylphosphonothiolate

Schedule: 1A03

CAS RN: HS code: 2930.90

Key: (78-92-2)-E1A3-EI

Molecular formula: C<sub>13</sub>H<sub>30</sub>NO<sub>2</sub>PS

CAS Index Name:

**IUPAC name:**

Synonyms:

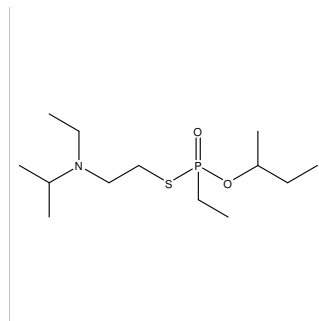

**Chemical name:** sec-Butyl S-2-N-ethyl-N-methylaminoethyl ethylphosphonothiolate

Schedule: 1A03

CAS RN: HS code: 2930.90

Key: (78-92-2)-E1A3-EM

Molecular formula: C<sub>11</sub>H<sub>26</sub>NO<sub>2</sub>PS

CAS Index Name:

**IUPAC name:**

Synonyms:

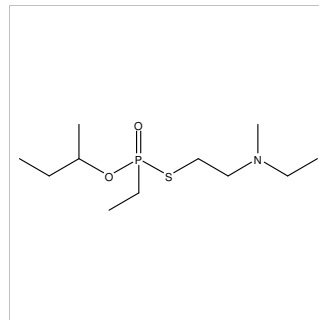

**Chemical name:** sec-Butyl S-2-N-ethyl-N-propylaminoethyl ethylphosphonothiolate

Schedule: 1A03

CAS RN: HS code: 2930.90

Key: (78-92-2)-E1A3-EP

Molecular formula: C<sub>13</sub>H<sub>30</sub>NO<sub>2</sub>PS

CAS Index Name:

**IUPAC name:**

Synonyms:

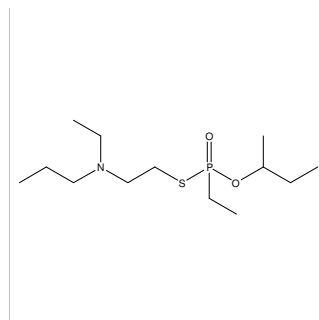

**Chemical name:** sec-Butyl S-2-N-isopropyl-N-methylaminoethyl ethylphosphonothiolate

Schedule: 1A03

CAS RN: HS code: 2930.90

Key: (78-92-2)-E1A3-IM

Molecular formula: C<sub>12</sub>H<sub>28</sub>NO<sub>2</sub>PS

CAS Index Name:

**IUPAC name:**

Synonyms:

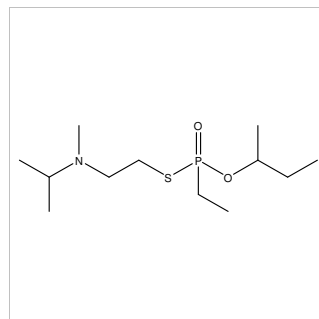

**Chemical name:** sec-Butyl S-2-N-isopropyl-N-propylaminoethyl ethylphosphonothiolate

Schedule: 1A03

CAS RN: HS code: 2930.90

Key: (78-92-2)-E1A3-IP

Molecular formula: C<sub>14</sub>H<sub>32</sub>NO<sub>2</sub>PS

CAS Index Name:

**IUPAC name:**

Synonyms:

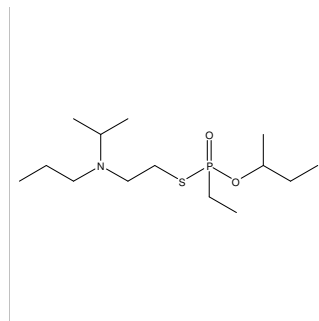

**Chemical name:** sec-Butyl S-2-N-methyl-N-propylaminoethyl ethylphosphonothiolate

Schedule: 1A03

CAS RN: HS code: 2930.90

Key: (78-92-2)-E1A3-MP

Molecular formula: C<sub>12</sub>H<sub>28</sub>NO<sub>2</sub>PS

CAS Index Name:

**IUPAC name:**

Synonyms:

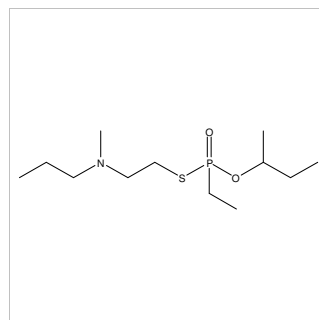

**Chemical name:** sec-butyl S-2-N-ethyl-N-isopropylaminoethyl isopropylphosphonothiolate

Schedule: 1A03

CAS RN: HS code: 2930.90

Key: (78-92-2)-I1A3-EI

Molecular formula: C<sub>14</sub>H<sub>32</sub>NO<sub>2</sub>PS

CAS Index Name:

**IUPAC name:**

Synonyms:

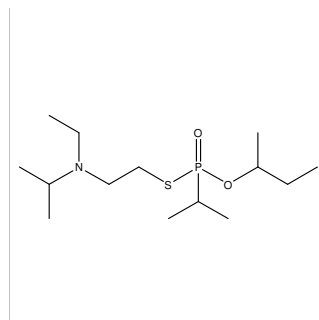

**Chemical name:** sec-Butyl S-2-N-ethyl-N-methylaminoethyl isopropylphosphonothiolate

Schedule: 1A03

CAS RN: HS code: 2930.90

Key: (78-92-2)-I1A3-EM

Molecular formula: C<sub>12</sub>H<sub>28</sub>NO<sub>2</sub>PS

CAS Index Name:

**IUPAC name:**

Synonyms:

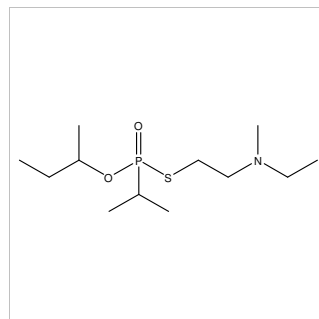

**Chemical name:** sec-Butyl S-2-N-ethyl-N-propylaminoethyl  
isopropylphosphonothiolate

Schedule: 1A03

CAS RN: HS code: 2930.90

Key: (78-92-2)-I1A3-EP

Molecular formula: C<sub>14</sub>H<sub>32</sub>NO<sub>2</sub>PS

CAS Index Name:

**IUPAC name:**

Synonyms:

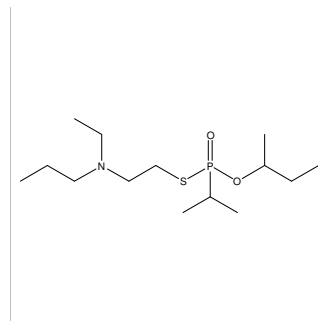

**Chemical name:** sec-Butyl S-2-N-isopropyl-N-methylaminoethyl  
isopropylphosphonothiolate

Schedule: 1A03

CAS RN: HS code: 2930.90

Key: (78-92-2)-I1A3-IM

Molecular formula: C<sub>13</sub>H<sub>30</sub>NO<sub>2</sub>PS

CAS Index Name:

**IUPAC name:**

Synonyms:

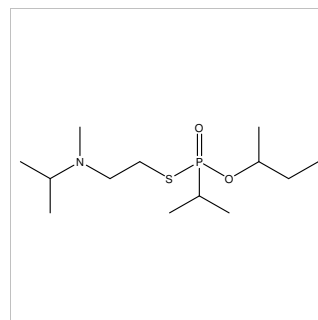

**Chemical name:** sec-Butyl S-2-N-isopropyl-N-propylaminoethyl  
isopropylphosphonothiolate

Schedule: 1A03

CAS RN: HS code: 2930.90

Key: (78-92-2)-I1A3-IP

Molecular formula: C<sub>15</sub>H<sub>34</sub>NO<sub>2</sub>PS

CAS Index Name:

**IUPAC name:**

Synonyms:

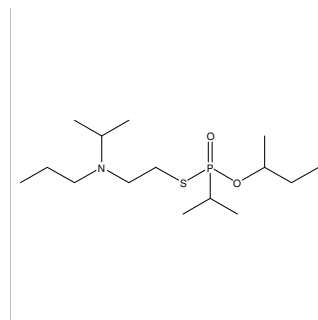

**Chemical name:** sec-Butyl S-2-dimethylaminoethyl  
isopropylphosphonothiolate

Schedule: 1A03

CAS RN: HS code: 2930.90

Key: (78-92-2)-I1A3-MM

Molecular formula: C<sub>11</sub>H<sub>26</sub>NO<sub>2</sub>PS

CAS Index Name: Phosphonothioic acid, 1-methylethyl-, S-[2-(dimethylamino)ethyl] O-(1-methylpropyl) ester

**IUPAC name:** sec-Butyl S-2-dimethylaminoethyl  
isopropylphosphonothioate

Synonyms: Phosphonothioic acid, 1-methylethyl-, S-[2-(dimethylamino)ethyl] O-1-methylpropyl ester  
O-sec-Butyl S-2-dimethylaminoethyl isopropylphosphonothiolate  
O-1-Methylpropyl S-2-dimethylaminoethyl isopropylphosphonothiolate  
Butan-2-yl S-2-dimethylaminoethyl isopropylphosphonothiolate  
But-2-yl S-2-dimethylaminoethyl isopropylphosphonothiolate  
1-Methylpropyl S-2-dimethylaminoethyl isopropylphosphonothiolate

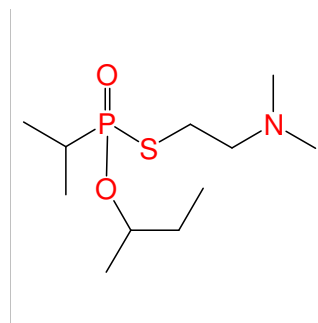

**Chemical name:** sec-Butyl S-2-N-methyl-N-propylaminoethyl  
isopropylphosphonothiolate

Schedule: 1A03

CAS RN: HS code: 2930.90

Key: (78-92-2)-I1A3-MP

Molecular formula: C<sub>13</sub>H<sub>30</sub>NO<sub>2</sub>PS

CAS Index Name:

**IUPAC name:**

Synonyms:

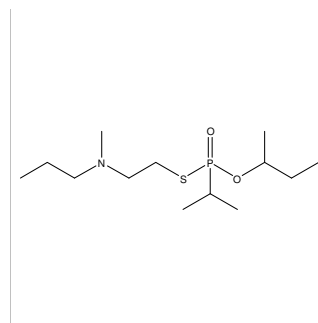

**Chemical name:** sec-Butyl S-2-dipropylaminoethyl  
isopropylphosphonothiolate

Schedule: 1A03

CAS RN: HS code: 2930.90

Key: (78-92-2)-I1A3-PP

Molecular formula: C<sub>15</sub>H<sub>34</sub>NO<sub>2</sub>PS

CAS Index Name: Phosphonothioic acid, 1-methylethyl-, S-[2-(dipropylamino)ethyl] O-(1-methylpropyl) ester

**IUPAC name:** sec-Butyl S-2-dipropylaminoethyl  
isopropylphosphonothioate

Synonyms: Phosphonothioic acid, 1-methylethyl-, S-[2-(dipropylamino)ethyl] O-1-methylpropyl ester  
O-sec-Butyl S-2-dipropylaminoethyl isopropylphosphonothiolate  
O-1-Methylpropyl S-2-dipropylaminoethyl isopropylphosphonothiolate  
1-Methylpropyl S-2-dipropylaminoethyl isopropylphosphonothiolate

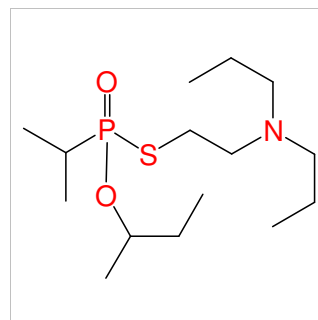

**Chemical name:** Sec-Butyl S-2-N-ethyl-N-isopropylaminoethyl methylphosphonothiolate

Schedule: 1A03

CAS RN: HS code: 2930.90

Key: (78-92-2)-M1A3-EI

Molecular formula: C<sub>12</sub>H<sub>28</sub>NO<sub>2</sub>PS

CAS Index Name:

**IUPAC name:**

Synonyms:

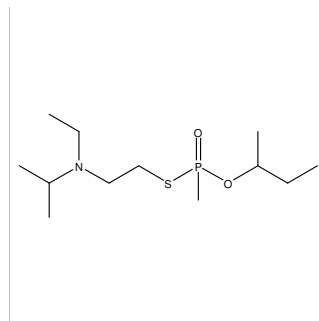

**Chemical name:** sec-Butyl S-2-N-ethyl-N-methylaminoethyl methylphosphonothiolate

Schedule: 1A03

CAS RN: HS code: 2930.90

Key: (78-92-2)-M1A3-EM

Molecular formula: C<sub>10</sub>H<sub>24</sub>NO<sub>2</sub>PS

CAS Index Name:

**IUPAC name:**

Synonyms:

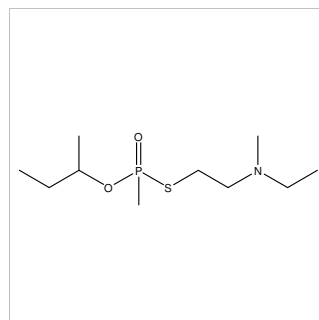

**Chemical name:** sec-Butyl S-2-N-ethyl-N-propylaminoethyl methylphosphonothiolate

Schedule: 1A03

CAS RN: HS code: 2930.90

Key: (78-92-2)-M1A3-EP

Molecular formula: C<sub>12</sub>H<sub>28</sub>NO<sub>2</sub>PS

CAS Index Name:

**IUPAC name:**

Synonyms:

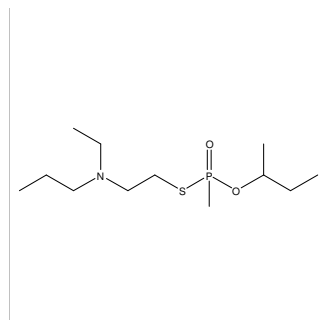

**Chemical name:** sec-Butyl S-2-N-isopropyl-N-methylaminoethyl methylphosphonothiolate

Schedule: 1A03

CAS RN: HS code: 2930.90

Key: (78-92-2)-M1A3-IM

Molecular formula: C<sub>11</sub>H<sub>26</sub>NO<sub>2</sub>PS

CAS Index Name:

**IUPAC name:**

Synonyms:

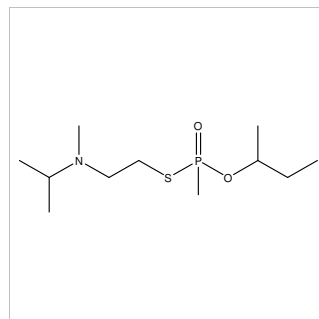

**Chemical name:** sec-Butyl S-2-N-isopropyl-N-propylaminoethyl methylphosphonothiolate

Schedule: 1A03

CAS RN: HS code: 2930.90

Key: (78-92-2)-M1A3-IP

Molecular formula: C<sub>13</sub>H<sub>30</sub>NO<sub>2</sub>PS

CAS Index Name:

**IUPAC name:**

Synonyms:

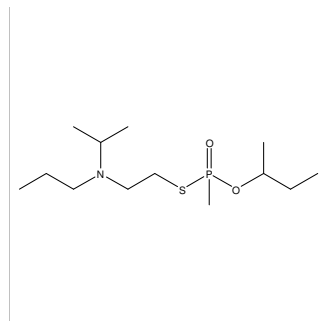

**Chemical name:** sec-Butyl S-2-N-methyl-N-propylaminoethyl methylphosphonothiolate

Schedule: 1A03

CAS RN: HS code: 2930.90

Key: (78-92-2)-M1A3-MP

Molecular formula: C<sub>11</sub>H<sub>26</sub>NO<sub>2</sub>PS

CAS Index Name:

**IUPAC name:**

Synonyms:

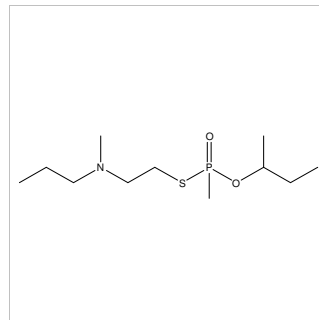

**Chemical name:** sec-Butyl S-2-dipropylaminoethyl methylphosphonothiolate

Schedule: 1A03

CAS RN: HS code: 2930.90

Key: (78-92-2)-M1A3-PP

Molecular formula: C<sub>13</sub>H<sub>30</sub>NO<sub>2</sub>PS

CAS Index Name: Phosphonothioic acid, methyl-, S-[2-(dipropylamino)ethyl] O-(1-methylpropyl) ester

**IUPAC name:** sec-Butyl S-2-dipropylaminoethyl methylphosphonothioate

Synonyms: Phosphonothioic acid, methyl-, S-[2-(dipropylamino)ethyl] O-1-methylpropyl ester

O-sec-Butyl S-2-dipropylaminoethyl methylphosphonothiolate

Butan-2-yl S-2-dipropylaminoethyl methylphosphonothiolate

But-2-yl S-2-dipropylaminoethyl methylphosphonothiolate

1-Methylpropyl S-2-dipropylaminoethyl methylphosphonothiolate

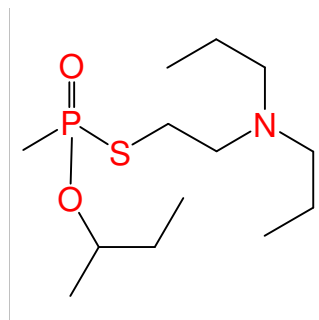



**Chemical name:** sec-Butyl S-2-N-ethyl-N-isopropylaminoethyl propylphosphonothiolate

Schedule: 1A03

CAS RN: HS code: 2930.90

Key: (78-92-2)-P1A3-EI

Molecular formula: C<sub>14</sub>H<sub>32</sub>NO<sub>2</sub>PS

CAS Index Name:

**IUPAC name:**

Synonyms:

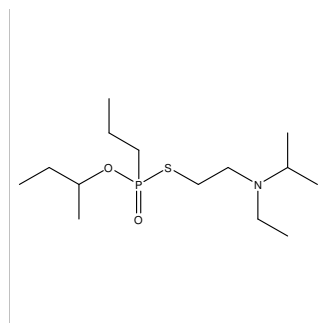

**Chemical name:** Sec-Butyl S-2-N-ethyl-N-methylaminoethyl propylphosphonothiolate

Schedule: 1A03

CAS RN: HS code: 2930.90

Key: (78-92-2)-P1A3-EM

Molecular formula: C<sub>12</sub>H<sub>28</sub>NO<sub>2</sub>PS

CAS Index Name:

**IUPAC name:**

Synonyms:

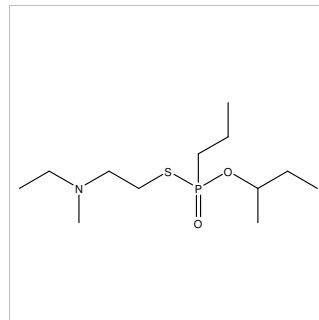

**Chemical name:** Sec-butyl S-2-N-ethyl-N-propylaminoethyl propylphosphonothiolate

Schedule: 1A03

CAS RN: HS code: 2930.90

Key: (78-92-2)-P1A3-EP

Molecular formula: C<sub>14</sub>H<sub>32</sub>NO<sub>2</sub>PS

CAS Index Name:

**IUPAC name:**

Synonyms:

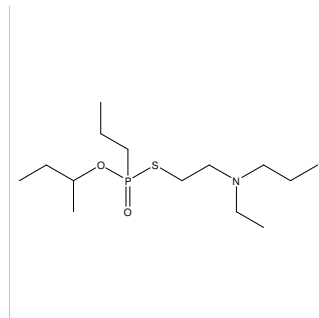

**Chemical name:** sec-Butyl S-2-N-isopropyl-N-methylaminoethyl propylphosphonothiolate

Schedule: 1A03

CAS RN: HS code: 2930.90

Key: (78-92-2)-P1A3-IM

Molecular formula: C<sub>13</sub>H<sub>30</sub>NO<sub>2</sub>PS

CAS Index Name:

**IUPAC name:**

Synonyms:

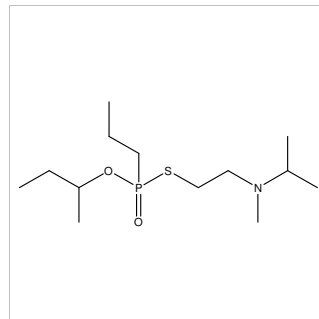

**Chemical name:** sec-Butyl S-2-N-isopropyl-N-propylaminoethyl propylphosphonothiolate

Schedule: 1A03

CAS RN: HS code: 2930.90

Key: (78-92-2)-P1A3-IP

Molecular formula: C<sub>15</sub>H<sub>34</sub>NO<sub>2</sub>PS

CAS Index Name:

**IUPAC name:**

Synonyms:

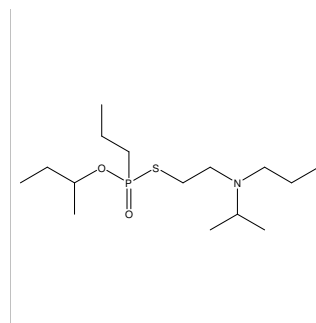

**Chemical name:** sec-Butyl S-2-dimethylaminoethyl propylphosphonothiolate

Schedule: 1A03

CAS RN: HS code: 2930.90

Key: (78-92-2)-P1A3-MM

Molecular formula: C<sub>11</sub>H<sub>26</sub>NO<sub>2</sub>PS

CAS Index Name: Phosphonothioic acid, propyl-, S-[2-(dimethylamino)ethyl] O-(1-methylpropyl) ester

**IUPAC name:** sec-Butyl S-2-dimethylaminoethyl propylphosphonothioate

Synonyms: Phosphonothioic acid, propyl-, S-[2-(dimethylamino)ethyl] O-1-methylpropyl ester

O-sec-Butyl S-2-dimethylaminoethyl propylphosphonothiolate

Butan-2-yl S-2-dimethylaminoethyl propylphosphonothiolate

But-2-yl S-2-dimethylaminoethyl propylphosphonothiolate

1-Methylpropyl S-2-dimethylaminoethyl propylphosphonothiolate

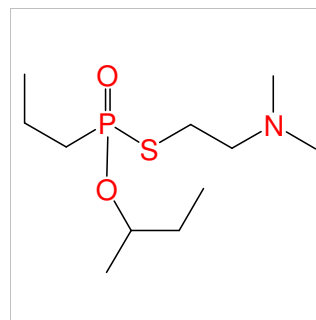

**Chemical name:** sec-Butyl S-2-N-methyl-N-propylaminoethyl propylphosphonothiolate

Schedule: 1A03

CAS RN: HS code: 2930.90

Key: (78-92-2)-P1A3-MP

Molecular formula: C<sub>13</sub>H<sub>30</sub>NO<sub>2</sub>PS

CAS Index Name:

**IUPAC name:**

Synonyms:

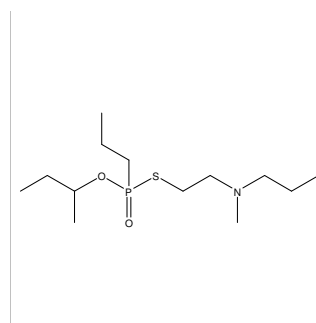

**Chemical name:** sec-Butyl S-2-dipropylaminoethyl propylphosphonothiolate

Schedule: 1A03

CAS RN: HS code: 2930.90

Key: (78-92-2)-P1A3-PP

Molecular formula: C<sub>15</sub>H<sub>34</sub>NO<sub>2</sub>PS

CAS Index Name: Phosphonothioic acid, propyl-, S-[2-(dipropylamino)ethyl] O-(1-methylpropyl) ester

**IUPAC name:** sec-Butyl S-2-dipropylaminoethyl propylphosphonothioate

Synonyms: Phosphonothioic acid, propyl-, S-[2-(dipropylamino)ethyl] O-1-methylpropyl ester

O-sec-Butyl S-2-dipropylaminoethyl propylphosphonothiolate

1-Methylpropyl S-2-dipropylaminoethyl propylphosphonothiolate

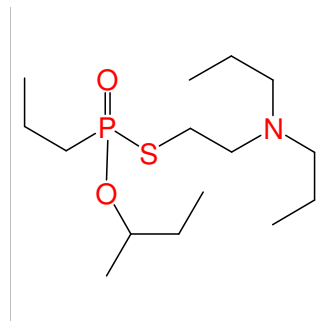

**Chemical name:** Cyclopentyl S-2-dimethylaminoethyl isopropylphosphonothiolate

Schedule: 1A03

CAS RN: HS code: 2930.90

Key: (96-41-3)-I1A3-MM

Molecular formula: C<sub>12</sub>H<sub>26</sub>NO<sub>2</sub>PS

CAS Index Name:

**IUPAC name:**

Synonyms:

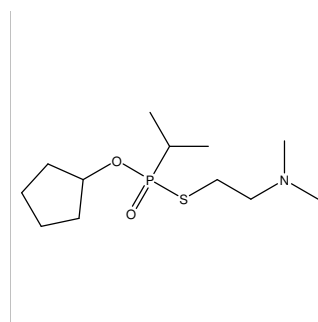

**Chemical name:** Cyclopentyl S-2-dipropylaminoethyl isopropylphosphonothiolate

Schedule: 1A03

CAS RN: HS code: 2930.90

Key: (96-41-3)-I1A3-PP

Molecular formula: C<sub>16</sub>H<sub>34</sub>NO<sub>2</sub>PS

CAS Index Name:

**IUPAC name:**

Synonyms:

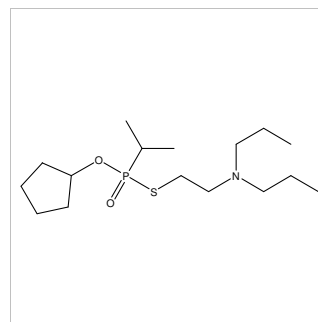

**Chemical name:** Cyclopentyl S-2-dimethylaminoethyl propylphosphonothiolate

Schedule: 1A03

CAS RN: HS code: 2930.90

Key: (96-41-3)-P1A3-MM

Molecular formula: C<sub>12</sub>H<sub>26</sub>NO<sub>2</sub>PS

CAS Index Name:

**IUPAC name:**

Synonyms:

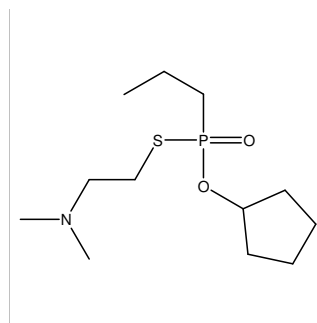

**Chemical name:** Cyclopentyl S-2-dipropylaminoethyl propylphosphonothiolate

Schedule: 1A03

CAS RN: HS code: 2930.90

Key: (96-41-3)-P1A3-PP

Molecular formula: C<sub>16</sub>H<sub>34</sub>NO<sub>2</sub>PS

CAS Index Name:

**IUPAC name:**

Synonyms:

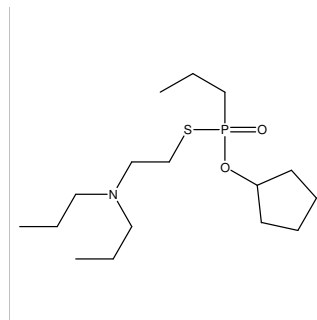

**Chemical name:** 4-tert-Butylcyclohexyl S-2-dimethylaminoethyl methylphosphonothiolate

Schedule: 1A03

CAS RN: HS code: 2930.90

Key: (98-52-2)-M1A3-MM

Molecular formula: C<sub>15</sub>H<sub>32</sub>NO<sub>2</sub>PS

CAS Index Name: Phosphonothioic acid, methyl-, S-[2-(dimethylamino)ethyl] O-(4-tert-butylcyclohexyl) ester

**IUPAC name:** 4-tert-Butylcyclohexyl S-2-dimethylaminoethyl methylphosphonothioate

Synonyms: O-4-tert-Butylcyclohexyl S-2-dimethylaminoethyl methylphosphonothiolate

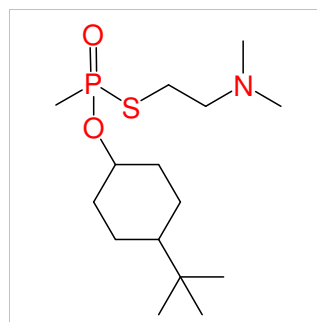

**Chemical name:** (R)-Cyclopentyl S-2-diisopropylaminoethyl methylphosphonothiolate

Schedule: 1A03

CAS RN: 102490-57-3 HS code: 2930.90

Key: 102490-57-3

Molecular formula: C<sub>14</sub>H<sub>30</sub>NO<sub>2</sub>PS

CAS Index Name: Phosphonothioic acid, methyl-, S-[2-(bis(1-methylethyl)amino)ethyl] O-cyclopentyl ester, (R)-

**IUPAC name:** (R)-Cyclopentyl S-2-diisopropylaminoethyl methylphosphonothioate

Synonyms: (R)-O-Cyclopentyl S-2-diisopropylaminoethyl methylphosphonothiolate

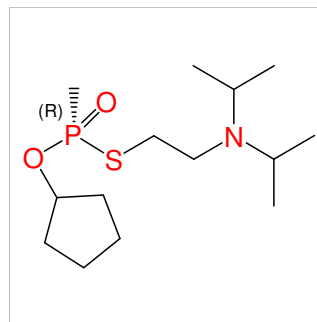

**Chemical name:** (S)-Cyclopentyl S-2-diisopropylaminoethyl methylphosphonothiolate

Schedule: 1A03

CAS RN: 102490-59-5

HS code: 2930.90

Key: 102490-59-5

Molecular formula: C<sub>14</sub>H<sub>30</sub>NO<sub>2</sub>PS

CAS Index Name: Phosphonothioic acid, methyl-, S-[2-(bis(1-methylethyl)amino)ethyl] O-cyclopentyl ester, (S)-

**IUPAC name:** (S)-Cyclopentyl S-2-diisopropylaminoethyl methylphosphonothioate

Synonyms: (S)-O-Cyclopentyl S-2-diisopropylaminoethyl methylphosphonothiolate

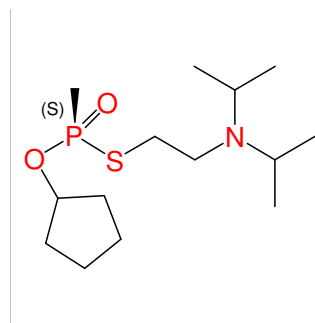

**Chemical name:** Ethyl S-2-diethylaminoethyl ethylphosphonothiolate oxalate

Schedule: 1A03

CAS RN: 108302-04-1

HS code: 2930.90

Key: 108302-04-1

Molecular formula: C<sub>10</sub>H<sub>24</sub>NO<sub>2</sub>PS.C<sub>2</sub>H<sub>2</sub>O<sub>4</sub>

CAS Index Name: Phosphonothioic acid, ethyl-, S-(2-diethylaminoethyl) O-ethyl ester, oxalate

**IUPAC name:** Ethyl S-2-diethylaminoethyl ethylphosphonothioate oxalate

Synonyms: O-Ethyl S-2-diethylaminoethyl ethylphosphonothiolate oxalate

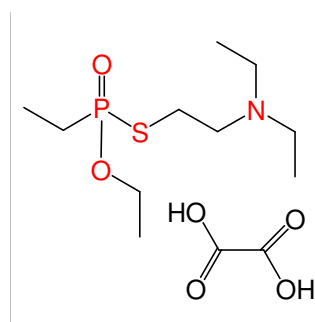

**Chemical name:** Methyl S-2-dimethylaminoethyl methylphosphonothiolate

Schedule: 1A03

CAS RN: 108490-92-2

HS code: 2930.90

Key: 108490-92-2

Molecular formula: C<sub>6</sub>H<sub>16</sub>NO<sub>2</sub>PS

CAS Index Name: Phosphonothioic acid, methyl-, S-[2-(dimethylamino)ethyl] O-methyl ester

**IUPAC name:** Methyl S-2-dimethylaminoethyl methylphosphonothioate

Synonyms: O-Methyl S-2-dimethylaminoethyl methylphosphonothiolate

O-Methyl S-2-(dimethylamino)ethyl methylphosphonothiolate

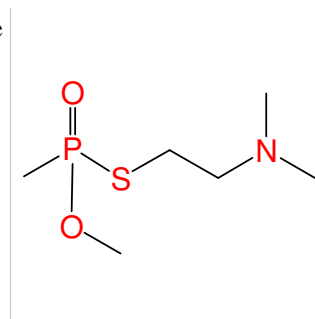

**Chemical name:** (S)-Cyclohexyl S-2-dimethylaminoethyl methylphosphonothiolate

Schedule: 1A03

CAS RN: 1186330-22-2

HS code: 2930.90

Key: 1186330-22-2

Molecular formula: C<sub>11</sub>H<sub>26</sub>NO<sub>2</sub>PS

CAS Index Name: Phosphonothioic acid, P-methyl-, S-[2-(dimethylamino)ethyl] O-(1,2,2-trimethylpropyl) ester, [P(S)]-

**IUPAC name:**

Synonyms:

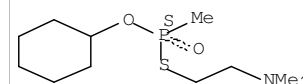

**Chemical name:** (R)-Ethyl S-2-diethylaminoethyl ethylphosphonothiolate

Schedule: 1A03

CAS RN: 1187548-77-1

HS code: 2930.90

Key: 1187548-77-1

Molecular formula: C<sub>10</sub>H<sub>24</sub>NO<sub>2</sub>PS

CAS Index Name: Phosphonothioic acid, P-ethyl-, S-[2-(diethylamino)ethyl] O-ethyl ester, [P(R)]-

**IUPAC name:**

Synonyms:

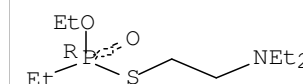

**Chemical name:** (S)-Ethyl S-2-diethylaminoethyl ethylphosphonothiolate

Schedule: 1A03

CAS RN: 1187548-79-3

HS code: 2930.90

Key: 1187548-79-3

Molecular formula: C<sub>10</sub>H<sub>24</sub>NO<sub>2</sub>PS

CAS Index Name: Phosphonothioic acid, P-ethyl-, S-[2-(diethylamino)ethyl] O-ethyl ester, [P(S)]-

**IUPAC name:**

Synonyms:

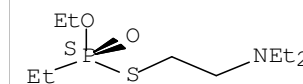

**Chemical name:** (R)-Ethyl S-2-diethylaminoethyl methylphosphonothiolate

Schedule: 1A03

CAS RN: 1187548-81-7

HS code: 2930.90

Key: 1187548-81-7

Molecular formula: C<sub>9</sub>H<sub>22</sub>NO<sub>2</sub>PS

CAS Index Name: Phosphonothioic acid, P-methyl-, S-[2-(diethylamino)ethyl] O-ethyl ester, [P(R)]-

**IUPAC name:**

Synonyms:

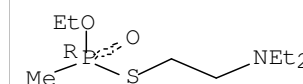

**Chemical name:** (S)-Ethyl S-2-diethylaminoethyl methylphosphonothiolate

Schedule: 1A03

CAS RN: 1187548-82-8

HS code: 2930.90

Key: 1187548-82-8

Molecular formula: C<sub>9</sub>H<sub>22</sub>NO<sub>2</sub>PS

CAS Index Name: Phosphonothioic acid, P-methyl-, S-[2-(diethylamino)ethyl] O-ethyl ester, [P(S)]-

**IUPAC name:**

Synonyms:

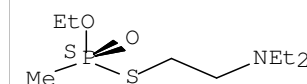

**Chemical name:** (R)-Cyclohexyl S-2-dimethylaminoethyl methylphosphonothiolate

Schedule: 1A03

CAS RN: 1220982-69-3

HS code: 2930.90

Key: 1220982-69-3

Molecular formula: C<sub>11</sub>H<sub>24</sub>NO<sub>2</sub>PS

CAS Index Name: Phosphonothioic acid, P-methyl-, O-cyclohexyl S-[2-(dimethylamino)ethyl] ester, [P(R)]-

**IUPAC name:**

Synonyms:

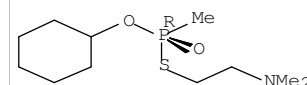

**Chemical name:** S-2-Dimethylaminoethyl ethylphosphonothiolate

Schedule: 1A03

CAS RN: 1253735-44-2

HS code: 2930.90

Key: 1253735-44-2

Molecular formula: C<sub>6</sub>H<sub>16</sub>NO<sub>2</sub>PS

CAS Index Name: Phosphonothioic acid, ethyl-, S-[2-(dimethylamino)ethyl] ester

**IUPAC name:** S-2-Dimethylaminoethyl ethylphosphonothioate

Synonyms: O-Hydrogen S-2-dimethylaminoethyl ethylphosphonothiolate

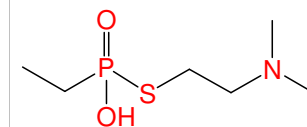

**Chemical name:** S-2-Dimethylaminoethyl propylphosphonothiolate

Schedule: 1A03

CAS RN: 1253735-61-3

HS code: 2930.90

Key: 1253735-61-3

Molecular formula: C<sub>7</sub>H<sub>18</sub>NO<sub>2</sub>PS

CAS Index Name: Phosphonothioic acid, propyl-, S-[2-(dimethylamino)ethyl] ester

**IUPAC name:** S-2-Dimethylaminoethyl propylphosphonothioate

Synonyms: O-Hydrogen S-2-dimethylaminoethyl propylphosphonothiolate

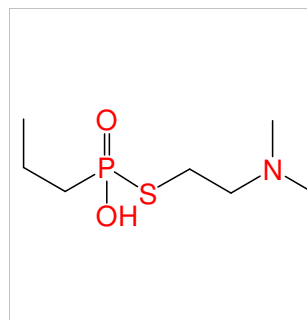

**Chemical name:** Decyl S-2-dimethylaminoethyl methylphosphonothiolate

Schedule: 1A03

CAS RN: 1253735-72-6

HS code: 2930.90

Key: 1253735-72-6

Molecular formula: C<sub>15</sub>H<sub>34</sub>NO<sub>2</sub>PS

CAS Index Name: Phosphonothioic acid, methyl-, S-[2-(dimethylamino)ethyl] O-decyl ester

**IUPAC name:** Decyl S-2-dimethylaminoethyl methylphosphonothioate

Synonyms: O-Decyl S-2-dimethylaminoethyl methylphosphonothiolate

Decyl S-[2-(dimethylamino)ethyl] methylphosphonothiolate

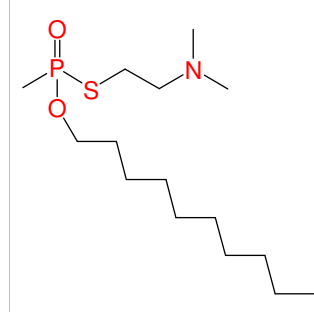

**Chemical name:** 3-Methylbutyl S-2-dipropylaminoethyl ethylphosphonothiolate

Schedule: 1A03

CAS RN: 1253735-73-7

HS code: 2930.90

Key: 1253735-73-7

Molecular formula: C<sub>15</sub>H<sub>34</sub>NO<sub>2</sub>PS

CAS Index Name: Phosphonothioic acid, ethyl-, S-[2-(dipropylamino)ethyl] O-(3-methylbutyl) ester

**IUPAC name:** 3-Methylbutyl S-2-dipropylaminoethyl ethylphosphonothioate

Synonyms: O-3-Methylbutyl S-2-dipropylaminoethyl ethylphosphonothiolate

Isopentyl S-2-dipropylaminoethyl ethylphosphonothiolate

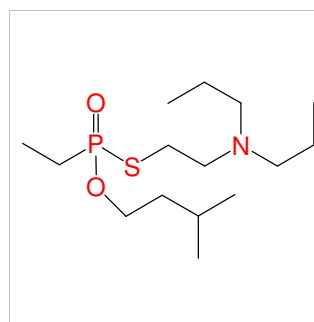

**Chemical name:** 3-Methylbutyl S-2-dipropylaminoethyl methylphosphonothiolate

Schedule: 1A03

CAS RN: 1253735-78-2

HS code: 2930.90

Key: 1253735-78-2

Molecular formula: C<sub>14</sub>H<sub>32</sub>NO<sub>2</sub>PS

CAS Index Name: Phosphonothioic acid, methyl-, S-[2-(dipropylamino)ethyl] O-(3-methylbutyl) ester

**IUPAC name:** 3-Methylbutyl S-2-dipropylaminoethyl methylphosphonothioate

Synonyms: O-3-Methylbutyl S-2-dipropylaminoethyl methylphosphonothiolate

Isopentyl S-2-dipropylaminoethyl methylphosphonothiolate

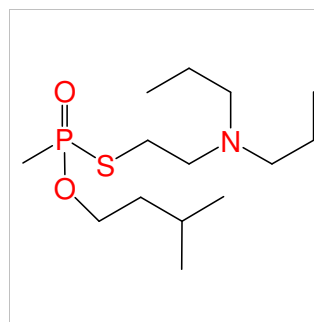



**Chemical name:** 2-Methylbutyl S-2-dipropylaminoethyl ethylphosphonothiolate

Schedule: 1A03

CAS RN: 1253735-81-7

HS code: 2930.90

Key: 1253735-81-7

Molecular formula: C<sub>15</sub>H<sub>34</sub>NO<sub>2</sub>PS

CAS Index Name: Phosphonothioic acid, ethyl-, S-[2-(dipropylamino)ethyl] O-(2-methylbutyl) ester

**IUPAC name:** 2-Methylbutyl S-2-dipropylaminoethyl ethylphosphonothioate

Synonyms: Phosphonothioic acid, ethyl-, S-[2-(dipropylamino)ethyl] O-(2-methylbutyl) ester  
O-2-Methylbutyl S-2-dipropylaminoethyl ethylphosphonothiolate

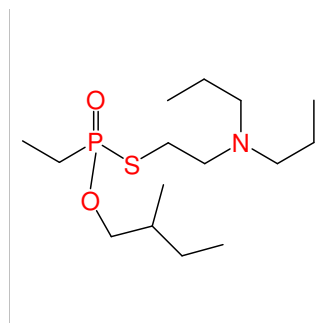

**Chemical name:** 2-Methylbutyl S-2-dipropylaminoethyl methylphosphonothiolate

Schedule: 1A03

CAS RN: 1253735-83-9

HS code: 2930.90

Key: 1253735-83-9

Molecular formula: C<sub>14</sub>H<sub>32</sub>NO<sub>2</sub>PS

CAS Index Name: Phosphonothioic acid, methyl-, S-[2-(dipropylamino)ethyl] O-(2-methylbutyl) ester

**IUPAC name:** 2-Methylbutyl S-2-dipropylaminoethyl methylphosphonothioate

Synonyms: Phosphonothioic acid, methyl-, S-[2-(dipropylamino)ethyl] O-2-methylbutyl ester  
O-2-Methylbutyl S-2-dipropylaminoethyl methylphosphonothiolate

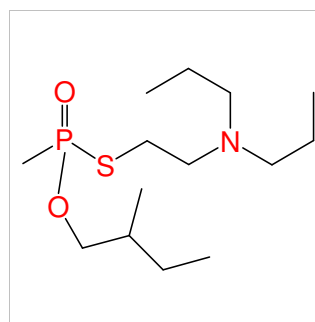

**Chemical name:** Nonyl S-2-dipropylaminoethyl ethylphosphonothiolate

Schedule: 1A03

CAS RN: 1253735-84-0

HS code: 2930.90

Key: 1253735-84-0

Molecular formula: C<sub>19</sub>H<sub>42</sub>NO<sub>2</sub>PS

CAS Index Name: Phosphonothioic acid, ethyl-, S-[2-(dipropylamino)ethyl] O-nonyl ester

**IUPAC name:** Nonyl S-2-dipropylaminoethyl ethylphosphonothioate

Synonyms: O-Nonyl S-2-dipropylaminoethyl ethylphosphonothiolate  
Nonyl S-[2-(dipropylamino)ethyl] ethylphosphonothiolate

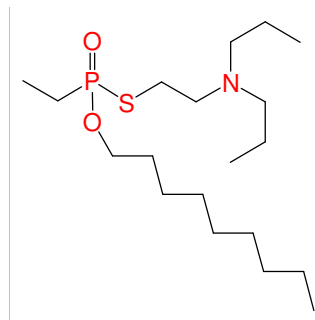

**Chemical name:** Nonyl S-2-dipropylaminoethyl methylphosphonothiolate

Schedule: 1A03

CAS RN: 1253736-10-5

HS code: 2930.90

Key: 1253736-10-5

Molecular formula: C<sub>18</sub>H<sub>40</sub>NO<sub>2</sub>PS

CAS Index Name: Phosphonothioic acid, methyl-, S-[2-(dipropylamino)ethyl] O-nonyl ester

**IUPAC name:** Nonyl S-2-dipropylaminoethyl methylphosphonothioate

Synonyms: O-Nonyl S-2-dipropylaminoethyl methylphosphonothiolate

Nonyl S-[2-(dipropylamino)ethyl] methylphosphonothiolate

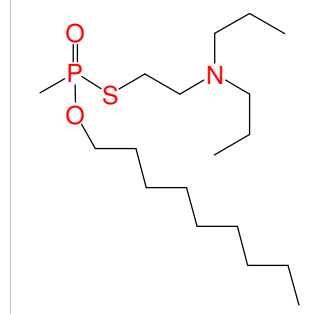

**Chemical name:** 2-Methylcyclopentyl S-2-dimethylaminoethyl ethylphosphonothiolate

Schedule: 1A03

CAS RN: 1253736-58-1

HS code: 2930.90

Key: 1253736-58-1

Molecular formula: C<sub>12</sub>H<sub>26</sub>NO<sub>2</sub>PS

CAS Index Name: Phosphonothioic acid, ethyl-, S-[2-(dimethylamino)ethyl] O-(2-methylcyclopentyl) ester

**IUPAC name:** 2-Methylcyclopentyl S-2-dimethylaminoethyl ethylphosphonothioate

Synonyms: O-2-Methylcyclopentyl S-2-dimethylaminoethyl ethylphosphonothiolate

2-Methylcyclopentyl S-[2-(dimethylamino)ethyl] ethylphosphonothiolate

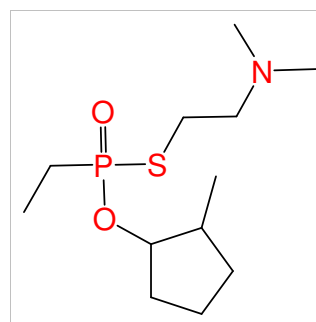

**Chemical name:** 2-Methylcyclopentyl S-2-dimethylaminoethyl methylphosphonothiolate

Schedule: 1A03

CAS RN: 1253736-59-2

HS code: 2930.90

Key: 1253736-59-2

Molecular formula: C<sub>11</sub>H<sub>24</sub>NO<sub>2</sub>PS

CAS Index Name: Phosphonothioic acid, methyl-, S-[2-(dimethylamino)ethyl] O-(2-methylcyclopentyl) ester

**IUPAC name:** 2-Methylcyclopentyl S-2-dimethylaminoethyl methylphosphonothioate

Synonyms: O-2-Methylcyclopentyl S-2-dimethylaminoethyl methylphosphonothiolate

2-Methylcyclopentyl S-[2-(dimethylamino)ethyl] methylphosphonothiolate

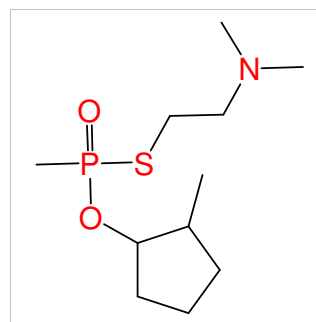

**Chemical name:** 1,2-Dimethylbutyl S-2-dimethylaminoethyl ethylphosphonothiolate

Schedule: 1A03

CAS RN: 1253739-43-3

HS code: 2930.90

Key: 1253739-43-3

Molecular formula: C<sub>12</sub>H<sub>28</sub>NO<sub>2</sub>PS

CAS Index Name: Phosphonothioic acid, ethyl-, S-[2-(dimethylamino)ethyl] O-(1,2-dimethylbutyl) ester

**IUPAC name:** 1,2-Dimethylbutyl S-2-dimethylaminoethyl ethylphosphonothioate

Synonyms: Phosphonothioic acid, ethyl-, S-[2-(dimethylamino)ethyl] O-3-methylpent-2-yl ester

O-1,2-Dimethylbutyl S-2-dimethylaminoethyl ethylphosphonothiolate

3-Methylpentan-2-yl S-2-dimethylaminoethyl ethylphosphonothiolate

3-Methylpent-2-yl S-2-dimethylaminoethyl ethylphosphonothiolate

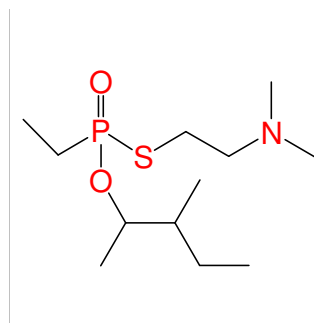

**Chemical name:** 1-Ethylpropyl S-2-dimethylaminoethyl ethylphosphonothiolate

Schedule: 1A03

CAS RN: 1253739-92-2

HS code: 2930.90

Key: 1253739-92-2

Molecular formula: C<sub>11</sub>H<sub>26</sub>NO<sub>2</sub>PS

CAS Index Name: Phosphonothioic acid, ethyl-, S-[2-(dimethylamino)ethyl] O-(1-ethylpropyl) ester

**IUPAC name:** 1-Ethylpropyl S-2-dimethylaminoethyl ethylphosphonothioate

Synonyms: S-[2-(dimethylamino)ethyl] O-pent-3-yl ethylphosphonothiolate

Phosphonothioic acid, ethyl-, S-[2-(dimethylamino)ethyl] O-(1-ethylpropyl) ester

Pentan-3-yl S-2-dimethylaminoethyl ethylphosphonothiolate

Pent-3-yl S-2-dimethylaminoethyl ethylphosphonothiolate

O-1-Ethylpropyl S-2-dimethylaminoethyl ethylphosphonothiolate

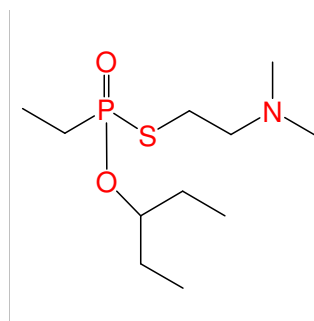

**Chemical name:** 1-Methylpentyl S-2-dimethylaminoethyl ethylphosphonothiolate

Schedule: 1A03

CAS RN: 1253739-96-6

HS code: 2930.90

Key: 1253739-96-6

Molecular formula: C<sub>12</sub>H<sub>28</sub>NO<sub>2</sub>PS

CAS Index Name: Phosphonothioic acid, ethyl-, S-[2-(dimethylamino)ethyl] O-(1-methylpentyl) ester

**IUPAC name:** 1-Methylpentyl S-2-dimethylaminoethyl ethylphosphonothioate

Synonyms: Phosphonothioic acid, ethyl-, S-[2-(dimethylamino)ethyl] O-hex-2-yl ester

O-1-Methylpentyl S-2-dimethylaminoethyl ethylphosphonothiolate

Hexan-2-yl S-2-dimethylaminoethyl ethylphosphonothiolate

Hex-2-yl S-2-dimethylaminoethyl ethylphosphonothiolate

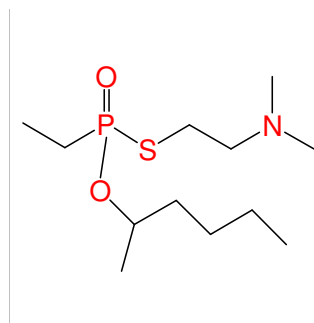

**Chemical name:** 1-Methylpentyl S-2-dipropylaminoethyl methylphosphonothiolate

Schedule: 1A03

CAS RN: 1253740-08-7

HS code: 2930.90

Key: 1253740-08-7

Molecular formula: C<sub>15</sub>H<sub>34</sub>NO<sub>2</sub>PS

CAS Index Name: Phosphonothioic acid, methyl-, S-[2-(dipropylamino)ethyl] O-(1-methylpentyl) ester

**IUPAC name:** 1-Methylpentyl S-2-dipropylaminoethyl methylphosphonothioate

Synonyms: Phosphonothioic acid, methyl-, S-[2-(dipropylamino)ethyl] O-hex-2-yl ester

O-1-Methylpentyl S-2-dipropylaminoethyl methylphosphonothiolate

Hexan-2-yl S-2-dipropylaminoethyl methylphosphonothiolate

Hex-2-yl S-2-dipropylaminoethyl methylphosphonothiolate

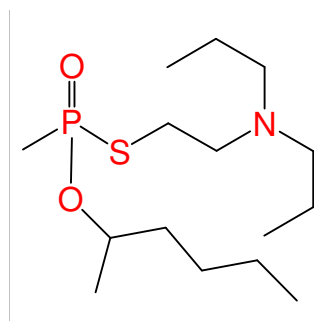

**Chemical name:** Ethyl S-2-diisopropylmethylammoniumethyl ethylphosphonothiolate iodide

Schedule: 1A03

CAS RN: 1253742-77-6

HS code: 2930.90

Key: 1253742-77-6

Molecular formula: C<sub>13</sub>H<sub>31</sub>INO<sub>2</sub>PS

CAS Index Name: 2-Propanaminium, N-(2-[[ethoxy(ethyl)phosphinyl]thio]ethyl)-N-(1-methylethyl)-N-methyl-, iodide

**IUPAC name:** N-(2-[[Ethoxy(ethyl)phosphoryl]thio]ethyl)-N-isopropyl-N-methylpropan-2-aminium iodide

Synonyms: O-Ethyl S-2-diisopropylmethylammoniumethyl ethylphosphonothiolate iodide

O-Ethyl S-2-(diisopropylmethylammonium)ethyl ethylphosphonothiolate iodide

N-(2-[[Ethoxy(ethyl)phosphoryl]sulfanyl]ethyl)-N-isopropyl-N-methylpropan-2-aminium iodide

Ethanaminium, N,N-diisopropyl-N-methyl-2-[(ethoxyethylphosphinyl)thio]-, iodide

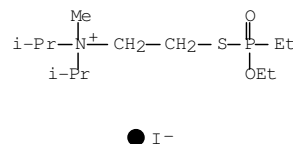

**Chemical name:** Ethyl S-2-dimethylaminoethyl isopropylphosphonothiolate

Schedule: 1A03

CAS RN: 1253744-32-9

HS code: 2930.90

Key: 1253744-32-9

Molecular formula: C<sub>9</sub>H<sub>22</sub>NO<sub>2</sub>PS

CAS Index Name: Phosphonothioic acid, 1-methylethyl-, S-[2-(dimethylamino)ethyl] O-ethyl ester

**IUPAC name:** Ethyl S-2-dimethylaminoethyl isopropylphosphonothioate

Synonyms: O-Ethyl S-2-dimethylaminoethyl isopropylphosphonothiolate

O-Ethyl S-2-(dimethylamino)ethyl isopropylphosphonothiolate

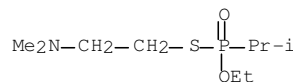

**Chemical name:** Ethyl S-2-diisopropylammoniumethyl methylphosphonothiolate chloride

Schedule: 1A03

CAS RN: 1253746-35-8

HS code: 2930.90

Key: 1253746-35-8

Molecular formula: C<sub>11</sub>H<sub>27</sub>ClNO<sub>2</sub>PS

CAS Index Name: 2-Propanaminium, N-(2-[[ethoxy(methyl)phosphinyl]thio]ethyl)-N-(1-methylethyl)-, chloride

**IUPAC name:** N-(2-[[Ethoxy(methyl)phosphoryl]thio]ethyl)-N-isopropylpropan-2-aminium chloride

Synonyms: O-Ethyl S-2-diisopropylammoniumethyl methylphosphonothiolate chloride

N-(2-[[Ethoxy(methyl)phosphoryl]sulfanyl]ethyl)-N-isopropylpropan-2-aminium chloride

Ethyl S-2-diisopropylaminoethyl methylphosphonothiolate, hydrochloride

O-Ethyl S-2-diisopropylaminoethyl methylphosphonothiolate hydrochloride

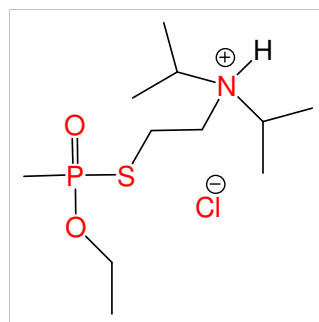

**Chemical name:** Isopropyl S-2-diethylpropylammoniumethyl ethylphosphonothiolate iodide

Schedule: 1A03

CAS RN: 1253752-57-6

HS code: 2930.90

Key: 1253752-57-6

Molecular formula: C<sub>14</sub>H<sub>33</sub>INO<sub>2</sub>PS

CAS Index Name: 1-Propanaminium, N-(2-[[[(ethyl)(1-methylethoxy)phosphinyl]thio]ethyl]-N,N-diethyl-, iodide

**IUPAC name:** N-(2-[[[(Ethyl)(1-methylethoxy)phosphoryl]thio]ethyl]-N,N-diethylpropan-1-aminium iodide

Synonyms: O-Isopropyl S-2-diethylpropylammoniumethyl ethylphosphonothiolate iodide  
O-Isopropyl S-2-(diethylpropylammonium)ethyl ethylphosphonothiolate iodide

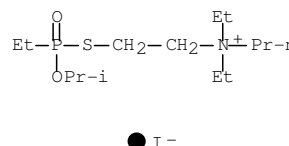

**Chemical name:** Isopropyl S-2-dimethylpropylammoniumethyl ethylphosphonothiolate iodide

Schedule: 1A03

CAS RN: 1253753-51-3

HS code: 2930.90

Key: 1253753-51-3

Molecular formula: C<sub>12</sub>H<sub>29</sub>INO<sub>2</sub>PS

CAS Index Name: Propanaminium, N-(2-[[[ethyl(isopropoxy)phosphinyl]thio]ethyl]-N,N-dimethyl-, iodide

**IUPAC name:** N-(2-[[[Ethyl(isopropoxy)phosphoryl]thio]ethyl]-N,N-dimethylpropan-1-aminium iodide

Synonyms: O-Isopropyl S-2-dimethylpropylammoniumethyl ethylphosphonothiolate iodide  
O-Isopropyl S-2-(dimethylpropylammonium)ethyl ethylphosphonothiolate iodide  
N-(2-[[[Ethyl(isopropoxy)phosphoryl]sulfanyl]ethyl]-N,N-dimethylpropan-1-aminium iodide

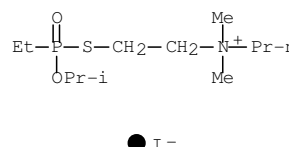

**Chemical name:** Propyl S-2-diisopropylaminoethyl ethylphosphonothiolate

Schedule: 1A03

CAS RN: 1253755-29-1

HS code: 2930.90

Key: 1253755-29-1

Molecular formula: C<sub>13</sub>H<sub>30</sub>NO<sub>2</sub>PS

CAS Index Name: Phosphonothioic acid, ethyl-, S-[2-(bis(1-methylethyl)amino)ethyl] O-propyl ester

**IUPAC name:** Propyl S-2-diisopropylaminoethyl ethylphosphonothioate

Synonyms: O-Propyl S-2-diisopropylaminoethyl ethylphosphonothiolate

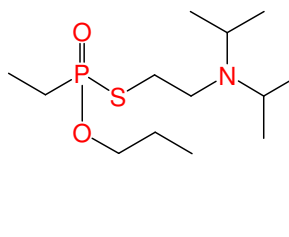

**Chemical name:** Propyl S-2-dipropylaminoethyl methylphosphonothiolate

Schedule: 1A03

CAS RN: 1253756-54-5

HS code: 2930.90

Key: 1253756-54-5

Molecular formula: C<sub>12</sub>H<sub>28</sub>NO<sub>2</sub>PS

CAS Index Name: Phosphonothioic acid, methyl-, S-[2-(dipropylamino)ethyl] O-propyl ester

**IUPAC name:** Propyl S-2-dipropylaminoethyl methylphosphonothioate

Synonyms: O-Propyl S-2-dipropylaminoethyl methylphosphonothiolate

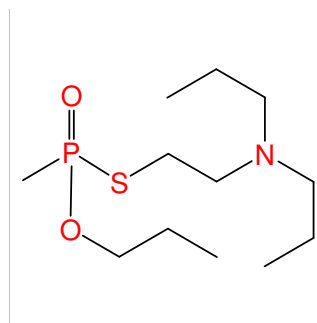

**Chemical name:** Butyl S-2-diisopropylaminoethyl ethylphosphonothiolate

Schedule: 1A03

CAS RN: 1253757-48-0

HS code: 2930.90

Key: 1253757-48-0

Molecular formula: C<sub>14</sub>H<sub>32</sub>NO<sub>2</sub>PS

CAS Index Name: Phosphonothioic acid, ethyl-, S-[2-(bis(1-methylethyl)amino)ethyl] O-butyl ester

**IUPAC name:** Butyl S-2-diisopropylaminoethyl ethylphosphonothioate

Synonyms: O-Butyl S-2-diisopropylaminoethyl ethylphosphonothiolate

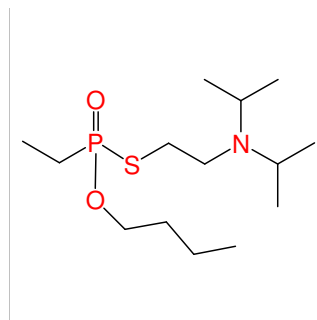

**Chemical name:** Butyl S-2-dipropylaminoethyl methylphosphonothiolate

Schedule: 1A03

CAS RN: 1253759-45-3

HS code: 2930.90

Key: 1253759-45-3

Molecular formula: C<sub>13</sub>H<sub>30</sub>NO<sub>2</sub>PS

CAS Index Name: Phosphonothioic acid, methyl-, S-[2-(dipropylamino)ethyl] O-butyl ester

**IUPAC name:** Butyl S-2-dipropylaminoethyl methylphosphonothioate

Synonyms: O-Butyl S-2-dipropylaminoethyl methylphosphonothiolate

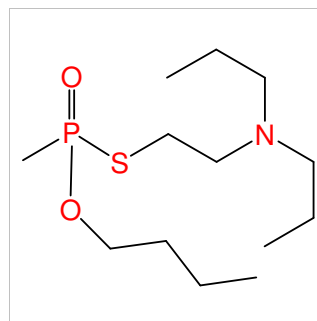

**Chemical name:** Pentyl S-2-diethylaminoethyl ethylphosphonothiolate

Schedule: 1A03

CAS RN: 1253761-22-6

HS code: 2930.90

Key: 1253761-22-6

Molecular formula: C<sub>13</sub>H<sub>30</sub>NO<sub>2</sub>PS

CAS Index Name: Phosphonothioic acid, ethyl-, S-[2-(diethylamino)ethyl] O-pentyl ester

**IUPAC name:** Pentyl S-2-diethylaminoethyl ethylphosphonothioate

Synonyms: O-Pentyl S-2-diethylaminoethyl ethylphosphonothiolate

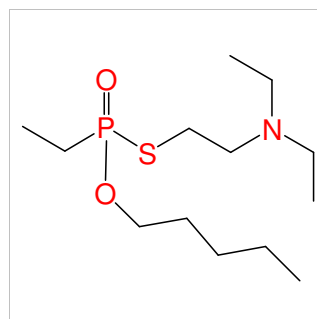

**Chemical name:** Pentyl S-2-dimethylaminoethyl ethylphosphonothiolate

Schedule: 1A03

CAS RN: 1253762-74-1

HS code: 2930.90

Key: 1253762-74-1

Molecular formula: C<sub>11</sub>H<sub>26</sub>NO<sub>2</sub>PS

CAS Index Name: Phosphonothioic acid, ethyl-, S-[2-(dimethylamino)ethyl] O-pentyl ester

**IUPAC name:** Pentyl S-2-dimethylaminoethyl ethylphosphonothioate

Synonyms: O-Pentyl S-2-dimethylaminoethyl ethylphosphonothiolate

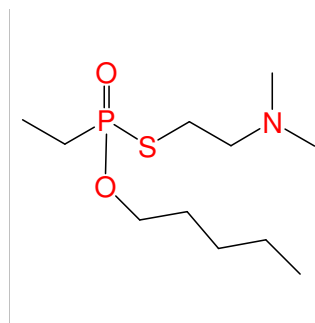

**Chemical name:** Pentyl S-2-dipropylaminoethyl ethylphosphonothiolate

Schedule: 1A03

CAS RN: 1253763-58-4

HS code: 2930.90

Key: 1253763-58-4

Molecular formula: C<sub>15</sub>H<sub>34</sub>NO<sub>2</sub>PS

CAS Index Name: Phosphonothioic acid, ethyl-, S-[2-(dipropylamino)ethyl] O-pentyl ester

**IUPAC name:** Pentyl S-2-dipropylaminoethyl ethylphosphonothioate

Synonyms: O-Pentyl S-2-dipropylaminoethyl ethylphosphonothiolate

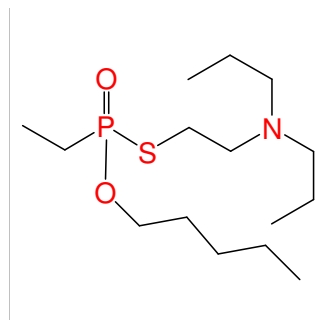

**Chemical name:** Pentyl S-2-diethylaminoethyl methylphosphonothiolate

Schedule: 1A03

CAS RN: 1253764-67-8

HS code: 2930.90

Key: 1253764-67-8

Molecular formula: C<sub>12</sub>H<sub>28</sub>NO<sub>2</sub>PS

CAS Index Name: Phosphonothioic acid, methyl-, S-[2-(diethylamino)ethyl] O-pentyl ester

**IUPAC name:** Pentyl S-2-diethylaminoethyl methylphosphonothioate

Synonyms: O-Pentyl S-2-diethylaminoethyl methylphosphonothiolate

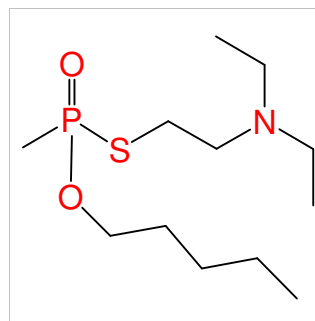

**Chemical name:** Pentyl S-2-dipropylaminoethyl methylphosphonothiolate

Schedule: 1A03

CAS RN: 1253765-64-8

HS code: 2930.90

Key: 1253765-64-8

Molecular formula: C<sub>14</sub>H<sub>32</sub>NO<sub>2</sub>PS

CAS Index Name: Phosphonothioic acid, methyl-, S-[2-(dipropylamino)ethyl] O-pentyl ester

**IUPAC name:** Pentyl S-2-dipropylaminoethyl methylphosphonothioate

Synonyms: O-Pentyl S-2-dipropylaminoethyl methylphosphonothiolate

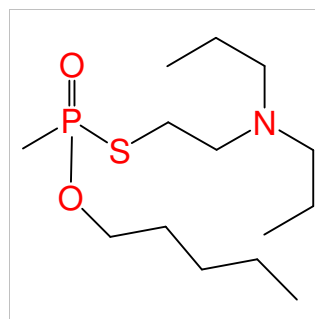



**Chemical name:** 2,2-Dimethylpropyl S-2-diethylaminoethyl ethylphosphonothiolate

Schedule: 1A03

CAS RN: 1253766-83-4

HS code: 2930.90

Key: 1253766-83-4

Molecular formula: C<sub>13</sub>H<sub>30</sub>NO<sub>2</sub>PS

CAS Index Name: Phosphonothioic acid, ethyl-, S-[2-(diethylamino)ethyl] O-(2,2-dimethylpropyl) ester

**IUPAC name:** 2,2-Dimethylpropyl S-2-diethylaminoethyl ethylphosphonothioate

Synonyms: O-2,2-Dimethylpropyl S-2-diethylaminoethyl ethylphosphonothiolate  
Neopentyl S-2-diethylaminoethyl ethylphosphonothiolate

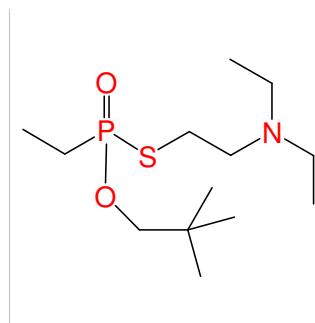

**Chemical name:** 2,2-Dimethylpropyl S-2-diisopropylaminoethyl ethylphosphonothiolate

Schedule: 1A03

CAS RN: 1253767-73-5

HS code: 2930.90

Key: 1253767-73-5

Molecular formula: C<sub>15</sub>H<sub>34</sub>NO<sub>2</sub>PS

CAS Index Name: Phosphonothioic acid, ethyl-, S-[2-(bis(1-methylethyl)amino)ethyl] O-(2,2-dimethylpropyl) ester

**IUPAC name:** 2,2-Dimethylpropyl S-2-diisopropylaminoethyl ethylphosphonothioate

Synonyms: O-2,2-Dimethylpropyl S-2-diisopropylaminoethyl ethylphosphonothiolate  
Neopentyl S-2-diisopropylaminoethyl ethylphosphonothiolate

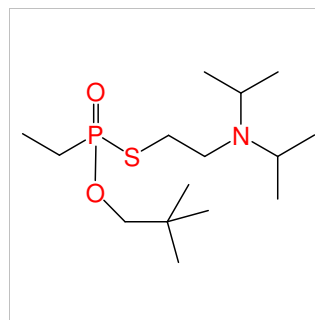

**Chemical name:** 2,2-Dimethylpropyl S-2-dimethylaminoethyl ethylphosphonothiolate

Schedule: 1A03

CAS RN: 1253768-73-8

HS code: 2930.90

Key: 1253768-73-8

Molecular formula: C<sub>11</sub>H<sub>26</sub>NO<sub>2</sub>PS

CAS Index Name: Phosphonothioic acid, ethyl-, S-[2-(dimethylamino)ethyl] O-(2,2-dimethylpropyl) ester

**IUPAC name:** 2,2-Dimethylpropyl S-2-dimethylaminoethyl ethylphosphonothioate

Synonyms: O-2,2-Dimethylpropyl S-2-dimethylaminoethyl ethylphosphonothiolate  
Neopentyl S-2-dimethylaminoethyl ethylphosphonothiolate

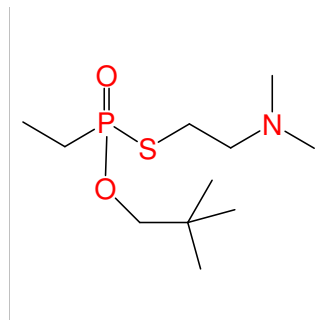

**Chemical name:** Isobutyl S-2-dimethylaminoethyl ethylphosphonothiolate

Schedule: 1A03

CAS RN: 1253771-21-9

HS code: 2930.90

Key: 1253771-21-9

Molecular formula: C<sub>10</sub>H<sub>24</sub>NO<sub>2</sub>PS

CAS Index Name: Phosphonothioic acid, ethyl-, S-[2-(dimethylamino)ethyl] O-(2-methylpropyl) ester

**IUPAC name:** Isobutyl S-2-dimethylaminoethyl ethylphosphonothioate

Synonyms: Phosphonothioic acid, ethyl-, S-[2-(dimethylamino)ethyl] O-2-methylpropyl ester

O-Isobutyl S-2-dimethylaminoethyl ethylphosphonothiolate

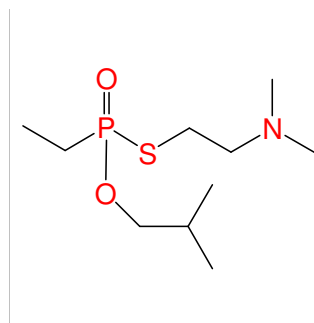

**Chemical name:** Isobutyl S-2-dipropylaminoethyl methylphosphonothiolate

Schedule: 1A03

CAS RN: 1253772-23-4

HS code: 2930.90

Key: 1253772-23-4

Molecular formula: C<sub>13</sub>H<sub>30</sub>NO<sub>2</sub>PS

CAS Index Name: Phosphonothioic acid, methyl-, S-[2-(dipropylamino)ethyl] O-(2-methylpropyl) ester

**IUPAC name:** Isobutyl S-2-dipropylaminoethyl methylphosphonothioate

Synonyms: Phosphonothioic acid, methyl-, S-[2-(dipropylamino)ethyl] O-2-methylpropyl ester

O-Isobutyl S-2-dipropylaminoethyl methylphosphonothiolate

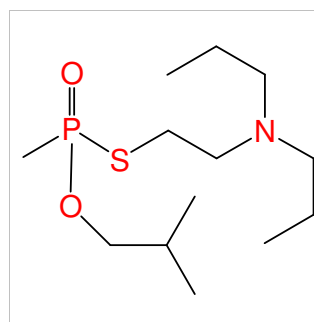

**Chemical name:** sec-Butyl S-2-diisopropylaminoethyl methylphosphonothiolate

Schedule: 1A03

CAS RN: 1253773-82-8

HS code: 2930.90

Key: 1253773-82-8

Molecular formula: C<sub>13</sub>H<sub>30</sub>NO<sub>2</sub>PS

CAS Index Name: Phosphonothioic acid, methyl-, S-[2-(bis(1-methylethyl)amino)ethyl] O-(1-methylpropyl) ester

**IUPAC name:** sec-Butyl S-2-diisopropylaminoethyl methylphosphonothioate

Synonyms: Phosphonothioic acid, methyl-, S-[2-(bis(1-methylethyl)amino)ethyl] O-1-methylpropyl

O-sec-Butyl S-2-diisopropylaminoethyl methylphosphonothiolate

Butan-2-yl S-2-diisopropylaminoethyl methylphosphonothiolate

But-2-yl S-2-diisopropylaminoethyl methylphosphonothiolate

1-Methylpropyl S-2-diisopropylaminoethyl methylphosphonothiolate

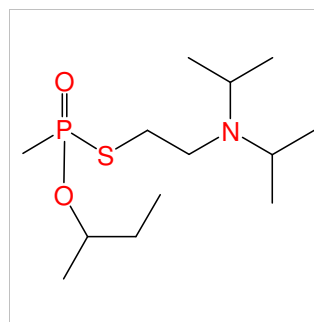

**Chemical name:** Cyclopentyl S-2-diisopropylaminoethyl ethylphosphonothiolate

Schedule: 1A03

CAS RN: 1253776-24-7

HS code: 2930.90

Key: 1253776-24-7

Molecular formula: C<sub>15</sub>H<sub>32</sub>NO<sub>2</sub>PS

CAS Index Name: Phosphonothioic acid, ethyl-, S-[2-(bis(1-methylethyl)amino)ethyl] O-cyclopentyl ester

**IUPAC name:** Cyclopentyl S-2-diisopropylaminoethyl ethylphosphonothioate

Synonyms: O-Cyclopentyl S-2-diisopropylaminoethyl ethylphosphonothiolate

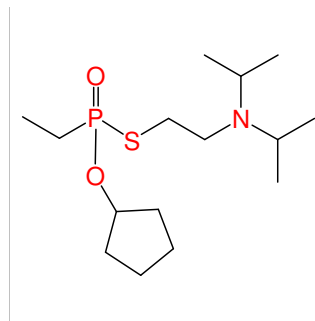

**Chemical name:** 1,2-Dimethylbutyl S-2-dimethylaminoethyl methylphosphonothiolate

Schedule: 1A03

CAS RN: 1253782-87-4

HS code: 2930.90

Key: 1253782-87-4

Molecular formula: C<sub>11</sub>H<sub>26</sub>NO<sub>2</sub>PS

CAS Index Name: Phosphonothioic acid, methyl-, S-[2-(dimethylamino)ethyl] O-(1,2-dimethylbutyl) ester

**IUPAC name:** 1,2-Dimethylbutyl S-2-dimethylaminoethyl methylphosphonothioate

Synonyms: Phosphonothioic acid, methyl-, S-[2-(dimethylamino)ethyl] O-3-methylpent-2-yl ester

O-1,2-Dimethylbutyl S-2-dimethylaminoethyl methylphosphonothiolate

3-Methylpentan-2-yl S-2-dimethylaminoethyl methylphosphonothiolate

3-Methylpent-2-yl S-2-dimethylaminoethyl methylphosphonothiolate

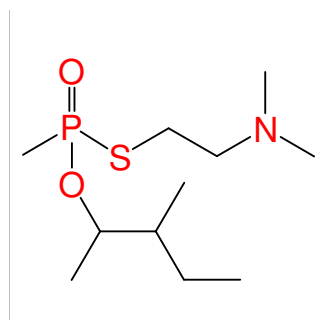

**Chemical name:** Methyl S-2-diisopropylaminoethyl isopropylphosphonothiolate

Schedule: 1A03

CAS RN: 1253782-88-5

HS code: 2930.90

Key: 1253782-88-5

Molecular formula: C<sub>12</sub>H<sub>28</sub>NO<sub>2</sub>PS

CAS Index Name: Phosphonothioic acid, 1-methylethyl-, S-[2-(bis(1-methylethyl)amino)ethyl] O-methyl ester

**IUPAC name:** Methyl S-2-diisopropylaminoethyl isopropylphosphonothioate

Synonyms: O-Methyl S-2-diisopropylaminoethyl isopropylphosphonothiolate

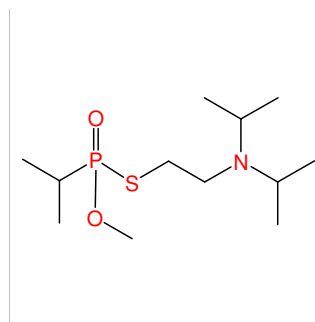

**Chemical name:** Pentyl S-2-diisopropylaminoethyl ethylphosphonothiolate

Schedule: 1A03

CAS RN: 1253782-89-6

HS code: 2930.90

Key: 1253782-89-6

Molecular formula: C<sub>15</sub>H<sub>34</sub>NO<sub>2</sub>PS

CAS Index Name: Phosphonothioic acid, ethyl-, S-[2-(bis(1-methylethyl)amino)ethyl] O-pentyl ester

**IUPAC name:** Pentyl S-2-diisopropylaminoethyl ethylphosphonothioate

Synonyms: O-Pentyl S-2-diisopropylaminoethyl ethylphosphonothiolate

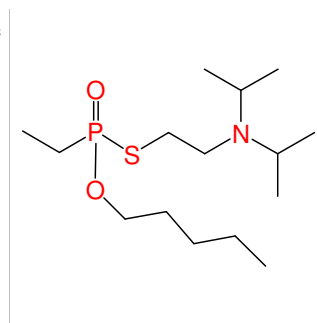

**Chemical name:** 1,2-Dimethylpropyl S-2-diisopropylaminoethyl methylphosphonothiolate

Schedule: 1A03

CAS RN: 1256554-56-9

HS code: 2930.90

Key: 1256554-56-9

Molecular formula: C<sub>14</sub>H<sub>32</sub>NO<sub>2</sub>PS

CAS Index Name: Phosphonothioic acid, methyl-, S-[2-(bis(1-methylethyl)amino)ethyl] O-(1,2-dimethylpropyl) ester

**IUPAC name:** 1,2-Dimethylpropyl S-2-diisopropylaminoethyl methylphosphonothioate

Synonyms: S-[2-(diisopropylamino)ethyl] O-3-Methylbut-2-yl methylphosphonothiolate

O-1,2-Dimethylpropyl S-2-diisopropylaminoethyl methylphosphonothiolate

3-Methylbutan-2-yl S-2-diisopropylaminoethyl methylphosphonothiolate

3-Methylbut-2-yl S-2-diisopropylaminoethyl methylphosphonothiolate

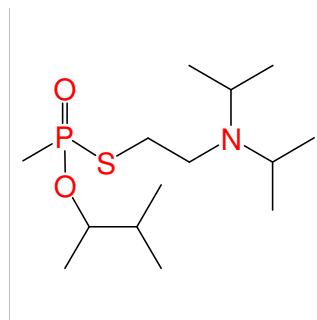

**Chemical name:** 1,2-Dimethylpropyl S-2-dipropylaminoethyl methylphosphonothiolate

Schedule: 1A03

CAS RN: 1256554-57-0

HS code: 2930.90

Key: 1256554-57-0

Molecular formula: C<sub>14</sub>H<sub>32</sub>NO<sub>2</sub>PS

CAS Index Name: Phosphonothioic acid, methyl-, S-[2-(dipropylamino)ethyl] O-(1,2-dimethylpropyl) ester

**IUPAC name:** 1,2-Dimethylpropyl S-2-dipropylaminoethyl methylphosphonothioate

Synonyms: S-[2-(dipropylamino)ethyl] O-3-methylbut-2-yl methylphosphonothiolate

O-1,2-Dimethylpropyl S-2-dipropylaminoethyl methylphosphonothiolate

3-Methylbutan-2-yl S-2-dipropylaminoethyl methylphosphonothiolate

3-Methylbut-2-yl S-2-dipropylaminoethyl methylphosphonothiolate

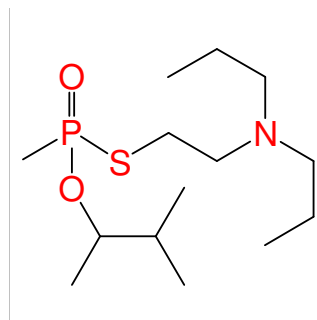

**Chemical name:** 1-Methylbutyl S-2-diethylaminoethyl ethylphosphonothiolate

Schedule: 1A03

CAS RN: 1256554-58-1

HS code: 2930.90

Key: 1256554-58-1

Molecular formula: C<sub>13</sub>H<sub>30</sub>NO<sub>2</sub>PS

CAS Index Name: Phosphonothioic acid, ethyl-, S-[2-(diethylamino)ethyl] O-(1-methylbutyl) ester

**IUPAC name:** 1-Methylbutyl S-2-diethylaminoethyl ethylphosphonothioate

Synonyms: S-[2-(Diethylamino)ethyl] O-pent-2-yl ethylphosphonothiolate

Pentan-2-yl S-2-diethylaminoethyl ethylphosphonothiolate

Pent-2-yl S-2-diethylaminoethyl ethylphosphonothiolate

O-1-Methylbutyl S-2-diethylaminoethyl ethylphosphonothiolate

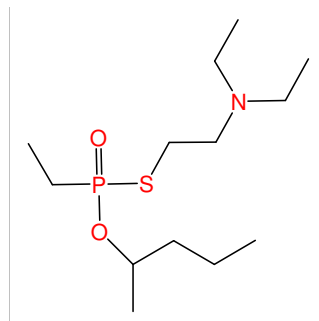

**Chemical name:** 1-Methylbutyl S-2-dimethylaminoethyl ethylphosphonothiolate

Schedule: 1A03

CAS RN: 1256554-59-2

HS code: 2930.90

Key: 1256554-59-2

Molecular formula: C<sub>11</sub>H<sub>26</sub>NO<sub>2</sub>PS

CAS Index Name: Phosphonothioic acid, ethyl-, S-[2-(dimethylamino)ethyl] O-(1-methylbutyl) ester

**IUPAC name:** 1-Methylbutyl S-2-dimethylaminoethyl ethylphosphonothioate

Synonyms: S-[2-(Dimethylamino)ethyl] O-pent-2-yl ethylphosphonothiolate

Pentan-2-yl S-2-dimethylaminoethyl ethylphosphonothiolate

Pent-2-yl S-2-dimethylaminoethyl ethylphosphonothiolate

O-1-Methylbutyl S-2-dimethylaminoethyl ethylphosphonothiolate

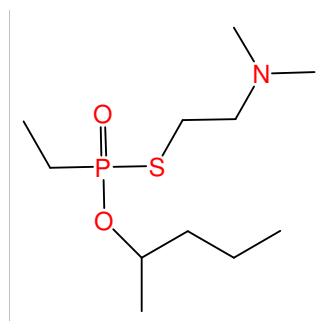

**Chemical name:** 1-Methylbutyl S-2-dipropylaminoethyl ethylphosphonothiolate

Schedule: 1A03

CAS RN: 1256554-60-5

HS code: 2930.90

Key: 1256554-60-5

Molecular formula: C<sub>15</sub>H<sub>34</sub>NO<sub>2</sub>PS

CAS Index Name: Phosphonothioic acid, ethyl-, S-[2-(dipropylamino)ethyl] O-(1-methylbutyl) ester

**IUPAC name:** 1-Methylbutyl S-2-dipropylaminoethyl ethylphosphonothioate

Synonyms: S-[2-(Dipropylamino)ethyl] O-pent-2-yl ethylphosphonothiolate

Pentan-2-yl S-2-dipropylaminoethyl ethylphosphonothiolate

Pent-2-yl S-2-dipropylaminoethyl ethylphosphonothiolate

O-1-Methylbutyl S-2-dipropylaminoethyl ethylphosphonothiolate

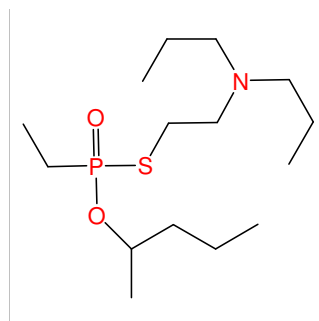

**Chemical name:** 1-Methylbutyl S-2-diethylaminoethyl methylphosphonothiolate

Schedule: 1A03

CAS RN: 1256554-61-6

HS code: 2930.90

Key: 1256554-61-6

Molecular formula: C<sub>12</sub>H<sub>28</sub>NO<sub>2</sub>PS

CAS Index Name: Phosphonothioic acid, methyl-, S-[2-(diethylamino)ethyl] O-(1-methylbutyl) ester

**IUPAC name:** 1-Methylbutyl S-2-diethylaminoethyl methylphosphonothioate

Synonyms: S-[2-(Diethylamino)ethyl] O-pent-2-yl methylphosphonothiolate

Pentan-2-yl S-2-diethylaminoethyl methylphosphonothiolate

Pent-2-yl S-2-diethylaminoethyl methylphosphonothiolate

O-1-Methylbutyl S-2-diethylaminoethyl methylphosphonothiolate

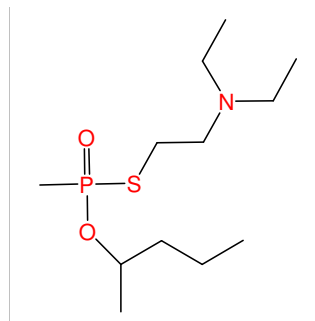

**Chemical name:** 1-Methylbutyl S-2-dimethylaminoethyl methylphosphonothiolate

Schedule: 1A03

CAS RN: 1256554-62-7

HS code: 2930.90

Key: 1256554-62-7

Molecular formula: C<sub>10</sub>H<sub>24</sub>NO<sub>2</sub>PS

CAS Index Name: Phosphonothioic acid, methyl-, S-[2-(dimethylamino)ethyl] O-(1-methylbutyl) ester

**IUPAC name:** 1-Methylbutyl S-2-dimethylaminoethyl methylphosphonothioate

Synonyms: S-[2-(Dimethylamino)ethyl] O-pent-2-yl methylphosphonothiolate

Pentan-2-yl S-2-dimethylaminoethyl methylphosphonothiolate

Pent-2-yl S-2-dimethylaminoethyl methylphosphonothiolate

O-1-Methylbutyl S-2-dimethylaminoethyl methylphosphonothiolate

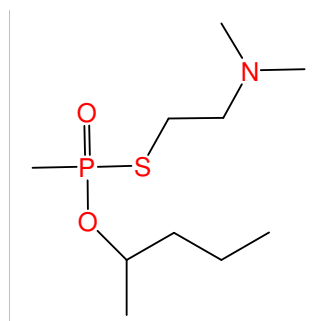

**Chemical name:** 1-Methylbutyl S-2-dipropylaminoethyl methylphosphonothiolate

Schedule: 1A03

CAS RN: 1256554-63-8

HS code: 2930.90

Key: 1256554-63-8

Molecular formula: C<sub>14</sub>H<sub>32</sub>NO<sub>2</sub>PS

CAS Index Name: Phosphonothioic acid, methyl-, S-[2-(dipropylamino)ethyl] O-(1-methylbutyl) ester

**IUPAC name:** 1-Methylbutyl S-2-dipropylaminoethyl methylphosphonothioate

Synonyms: S-[2-(Dipropylamino)ethyl] O-pent-2-yl methylphosphonothiolate

Pentan-2-yl S-2-dipropylaminoethyl methylphosphonothiolate

Pent-2-yl S-2-dipropylaminoethyl methylphosphonothiolate

O-1-Methylbutyl S-2-dipropylaminoethyl methylphosphonothiolate

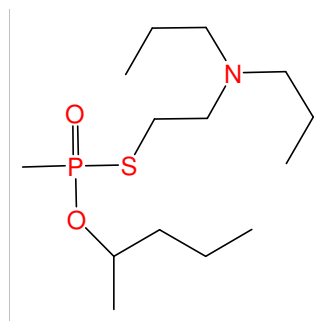

**Chemical name:** 1,3-Dimethylbutyl S-2-diisopropylaminoethyl methylphosphonothiolate

Schedule: 1A03

CAS RN: 1256572-04-9

HS code: 2930.90

Key: 1256572-04-9

Molecular formula: C<sub>15</sub>H<sub>34</sub>NO<sub>2</sub>PS

CAS Index Name: Phosphonothioic acid, methyl-, S-[2-(bis(1-methylethyl)amino)ethyl] O-(1,3-dimethylbutyl) ester

**IUPAC name:** 1,3-Dimethylbutyl S-2-diisopropylaminoethyl methylphosphonothioate

Synonyms: O-1,3-Dimethylbutyl S-2-diisopropylaminoethyl methylphosphonothiolate

4-Methylpentan-2-yl S-2-diisopropylaminoethyl methylphosphonothiolate

4-Methylpent-2-yl S-2-diisopropylaminoethyl methylphosphonothiolate

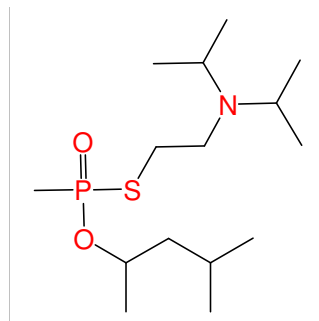

**Chemical name:** Cyclohexyl S-2-diisopropylaminoethyl ethylphosphonothiolate

Schedule: 1A03

CAS RN: 1256572-05-0

HS code: 2930.90

Key: 1256572-05-0

Molecular formula: C<sub>16</sub>H<sub>34</sub>NO<sub>2</sub>PS

CAS Index Name: Phosphonothioic acid, ethyl-, S-[2-(bis(1-methylethyl)amino)ethyl] O-cyclohexyl ester

**IUPAC name:** Cyclohexyl S-2-diisopropylaminoethyl ethylphosphonothioate

Synonyms: O-Cyclohexyl S-2-diisopropylaminoethyl ethylphosphonothiolate

Cyclohexyl S-[2-bis-(1-methylethyl)amino)ethyl] ethylphosphonothiolate

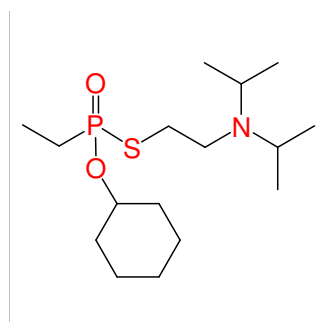

**Chemical name:** Cyclohexyl S-2-dimethylaminoethyl ethylphosphonothiolate

Schedule: 1A03

CAS RN: 1256572-06-1

HS code: 2930.90

Key: 1256572-06-1

Molecular formula: C<sub>12</sub>H<sub>26</sub>NO<sub>2</sub>PS

CAS Index Name: Phosphonothioic acid, ethyl-, S-[2-(dimethylamino)ethyl] O-cyclohexyl ester

**IUPAC name:** Cyclohexyl S-2-dimethylaminoethyl ethylphosphonothioate

Synonyms: O-Cyclohexyl S-2-dimethylaminoethyl ethylphosphonothiolate

Cyclohexyl S-[2-(dimethylamino)ethyl] ethylphosphonothiolate

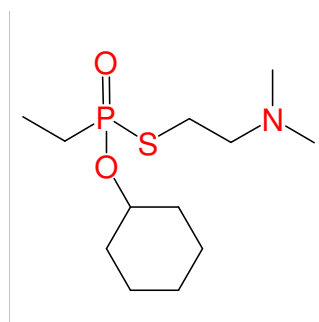

**Chemical name:** Cyclohexyl S-2-diisopropylaminoethyl methylphosphonothiolate

Schedule: 1A03

CAS RN: 1256572-07-2

HS code: 2930.90

Key: 1256572-07-2

Molecular formula: C<sub>15</sub>H<sub>32</sub>NO<sub>2</sub>PS

CAS Index Name: Phosphonothioic acid, methyl-, S-[2-(bis(1-methylethyl)amino)ethyl] O-cyclohexyl ester

**IUPAC name:** Cyclohexyl S-2-diisopropylaminoethyl methylphosphonothioate

Synonyms: O-Cyclohexyl S-2-diisopropylaminoethyl methylphosphonothiolate

Cyclohexyl S-[2-[bis-(1-methylethyl)amino]-ethyl] methylphosphonothiolate

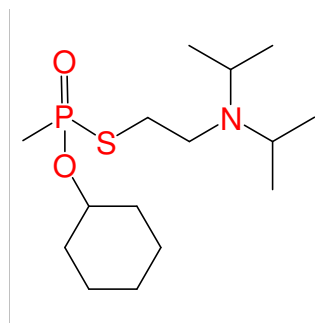

**Chemical name:** Cyclohexyl S-2-dipropylaminoethyl methylphosphonothiolate

Schedule: 1A03

CAS RN: 1256572-08-3

HS code: 2930.90

Key: 1256572-08-3

Molecular formula: C<sub>15</sub>H<sub>32</sub>NO<sub>2</sub>PS

CAS Index Name: Phosphonothioic acid, methyl-, S-[2-(dipropylamino)ethyl] O-cyclohexyl ester

**IUPAC name:** Cyclohexyl S-2-dipropylaminoethyl methylphosphonothioate

Synonyms: O-Cyclohexyl S-2-dipropylaminoethyl methylphosphonothiolate

Cyclohexyl S-[2-(dipropylamino)ethyl] methylphosphonothiolate

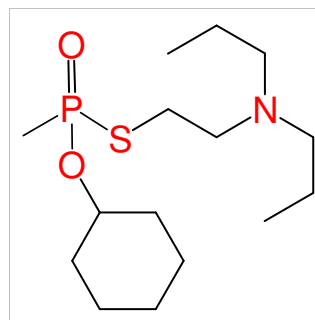

**Chemical name:** Hexyl S-2-dimethylaminoethyl ethylphosphonothiolate

Schedule: 1A03

CAS RN: 1256572-09-4

HS code: 2930.90

Key: 1256572-09-4

Molecular formula: C<sub>12</sub>H<sub>28</sub>NO<sub>2</sub>PS

CAS Index Name: Phosphonothioic acid, ethyl-, S-[2-(dimethylamino)ethyl] O-hexyl ester

**IUPAC name:** Hexyl S-2-dimethylaminoethyl ethylphosphonothioate

Synonyms: O-Hexyl S-2-dimethylaminoethyl ethylphosphonothiolate

Hexyl S-[2-(dimethylamino)ethyl] ethylphosphonothiolate

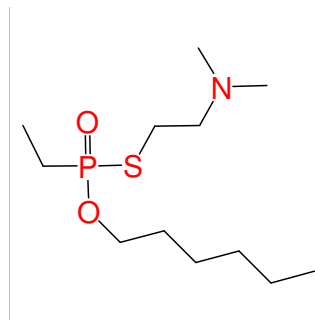



**Chemical name:** 2-Methylpentyl S-2-dimethylaminoethyl ethylphosphonothiolate

Schedule: 1A03

CAS RN: 1256572-26-5

HS code: 2930.90

Key: 1256572-26-5

Molecular formula: C<sub>12</sub>H<sub>28</sub>NO<sub>2</sub>PS

CAS Index Name: Phosphonothioic acid, ethyl-, S-[2-(dimethylamino)ethyl] O-(2-methylpentyl) ester

**IUPAC name:** 2-Methylpentyl S-2-dimethylaminoethyl ethylphosphonothioate

Synonyms: O-2-Methylpentyl S-2-dimethylaminoethyl ethylphosphonothiolate

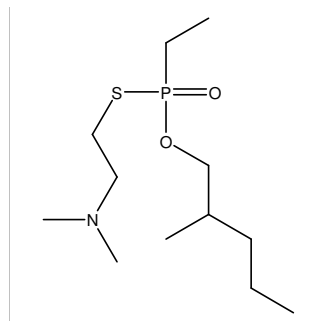

**Chemical name:** 2-Methylpentyl S-2-diisopropylaminoethyl methylphosphonothiolate

Schedule: 1A03

CAS RN: 1256572-27-6

HS code: 2930.90

Key: 1256572-27-6

Molecular formula: C<sub>15</sub>H<sub>34</sub>NO<sub>2</sub>PS

CAS Index Name: Phosphonothioic acid, methyl-, S-[2-(bis(1-methylethyl)amino)ethyl] O-(2-methylpentyl) ester

**IUPAC name:** 2-Methylpentyl S-2-diisopropylaminoethyl methylphosphonothioate

Synonyms: O-2-Methylpentyl S-2-diisopropylaminoethyl methylphosphonothiolate

2-Methylpentyl S-[2-(diisopropylamino)ethyl] methylphosphonothiolate

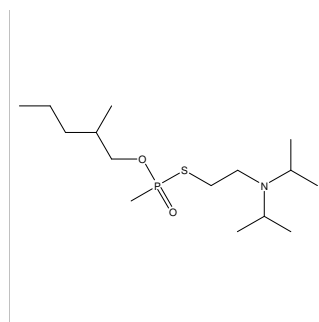

**Chemical name:** 2-Methylpentyl S-2-dimethylaminoethyl methylphosphonothiolate

Schedule: 1A03

CAS RN: 1256572-28-7

HS code: 2930.90

Key: 1256572-28-7

Molecular formula: C<sub>11</sub>H<sub>26</sub>NO<sub>2</sub>PS

CAS Index Name: Phosphonothioic acid, methyl-, S-[2-(dimethylamino)ethyl] O-(2-methylpentyl) ester

**IUPAC name:** 2-Methylpentyl S-2-dimethylaminoethyl methylphosphonothioate

Synonyms: O-2-Methylpentyl S-2-dimethylaminoethyl methylphosphonothiolate

2-Methylpentyl S-[2-(dimethylamino)ethyl] methylphosphonothiolate

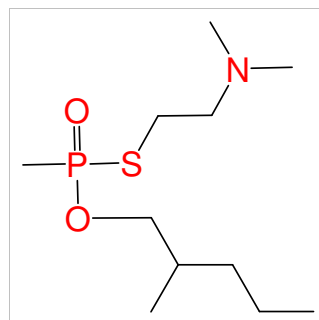

**Chemical name:** 2-Methylpentyl S-2-dipropylaminoethyl methylphosphonothiolate

Schedule: 1A03

CAS RN: 1256572-29-8

HS code: 2930.90

Key: 1256572-29-8

Molecular formula: C<sub>15</sub>H<sub>34</sub>NO<sub>2</sub>PS

CAS Index Name: Phosphonothioic acid, methyl-, S-[2-(dipropylamino)ethyl] O-(2-methylpentyl) ester

**IUPAC name:** 2-Methylpentyl S-2-dipropylaminoethyl methylphosphonothioate

Synonyms: O-2-Methylpentyl S-2-dipropylaminoethyl methylphosphonothiolate

2-Methylpentyl S-[2-(dipropylamino)ethyl] methylphosphonothiolate

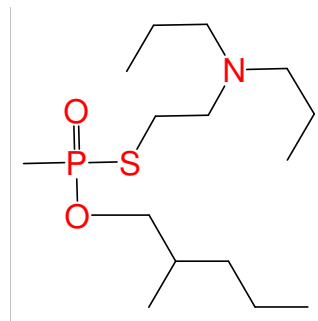

**Chemical name:** 1-Ethylpropyl S-2-diethylaminoethyl methylphosphonothiolate

Schedule: 1A03

CAS RN: 1256572-30-1

HS code: 2930.90

Key: 1256572-30-1

Molecular formula: C<sub>12</sub>H<sub>28</sub>NO<sub>2</sub>PS

CAS Index Name: Phosphonothioic acid, methyl-, S-[2-(diethylamino)ethyl] O-(1-ethylpropyl) ester

**IUPAC name:** 1-Ethylpropyl S-2-diethylaminoethyl methylphosphonothioate

Synonyms: S-[2-(diethylamino)ethyl] O-pent-3-yl methylphosphonothiolate

Phosphonothioic acid, methyl-, S-[2-(diethylamino)ethyl] O-(1-ethylpropyl) ester

Pentan-3-yl S-2-diethylaminoethyl methylphosphonothiolate

Pent-3-yl S-2-diethylaminoethyl methylphosphonothiolate

O-1-Ethylpropyl S-2-diethylaminoethyl methylphosphonothiolate

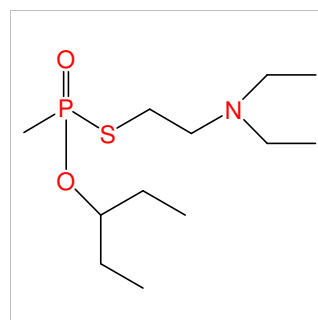

**Chemical name:** 1-Ethylpropyl S-2-diisopropylaminoethyl methylphosphonothiolate

Schedule: 1A03

CAS RN: 1256572-31-2

HS code: 2930.90

Key: 1256572-31-2

Molecular formula: C<sub>14</sub>H<sub>32</sub>NO<sub>2</sub>PS

CAS Index Name: Phosphonothioic acid, methyl-, S-[2-(bis(1-methylethyl)amino)ethyl] O-(1-ethylpropyl) ester

**IUPAC name:** 1-Ethylpropyl S-2-diisopropylaminoethyl methylphosphonothioate

Synonyms: S-[2-(diisopropylamino)ethyl] O-pent-3-yl methylphosphonothiolate

Phosphonothioic acid, methyl-, S-[2-(bis(1-methylethyl)amino)ethyl] O-(1-ethylpropyl)

Pentan-3-yl S-2-diisopropylaminoethyl methylphosphonothiolate

Pent-3-yl S-2-diisopropylaminoethyl methylphosphonothiolate

O-1-Ethylpropyl S-2-diisopropylaminoethyl methylphosphonothiolate

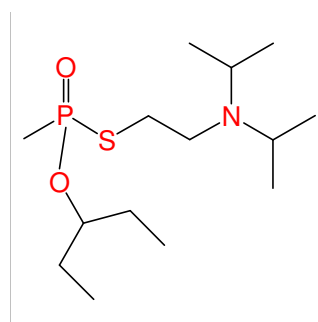

**Chemical name:** 1-Ethylpropyl S-2-dipropylaminoethyl methylphosphonothiolate

Schedule: 1A03

CAS RN: 1256572-32-3

HS code: 2930.90

Key: 1256572-32-3

Molecular formula: C<sub>14</sub>H<sub>32</sub>NO<sub>2</sub>PS

CAS Index Name: Phosphonothioic acid, methyl-, S-[2-(dipropylamino)ethyl] O-(1-ethylpropyl) ester

**IUPAC name:** 1-Ethylpropyl S-2-dipropylaminoethyl methylphosphonothioate

Synonyms: S-[2-(dipropylamino)ethyl] O-pent-3-yl methylphosphonothiolate

Phosphonothioic acid, methyl-, S-[2-(dipropylamino)ethyl] O-(1-ethylpropyl) ester

Pentan-3-yl S-2-dipropylaminoethyl methylphosphonothiolate

Pent-3-yl S-2-dipropylaminoethyl methylphosphonothiolate

O-1-Ethylpropyl S-2-dipropylaminoethyl methylphosphonothiolate

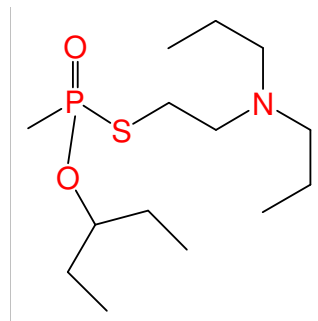

**Chemical name:** 1,2-Dimethylpropyl S-2-diethylaminoethyl ethylphosphonothiolate

Schedule: 1A03

CAS RN: 1256572-33-4

HS code: 2930.90

Key: 1256572-33-4

Molecular formula: C<sub>13</sub>H<sub>30</sub>NO<sub>2</sub>PS

CAS Index Name: Phosphonothioic acid, ethyl-, S-[2-(diethylamino)ethyl] O-(1,2-dimethylpropyl) ester

**IUPAC name:** 1,2-Dimethylpropyl S-2-diethylaminoethyl ethylphosphonothioate

Synonyms: S-[2-(Diethylamino)ethyl] O-3-methylbut-2-yl ethylphosphonothiolate

Phosphonothioic acid, ethyl-, S-[2-(diethylamino)ethyl] O-3-methylbut-2-yl ester

Phosphonothioic acid, ethyl-, S-[2-(diethylamino)ethyl] O-(1,2-dimethylpropyl) ester

O-1,2-Dimethylpropyl S-2-diethylaminoethyl ethylphosphonothiolate

3-Methylbutan-2-yl S-2-diethylaminoethyl ethylphosphonothiolate

3-Methylbut-2-yl S-2-diethylaminoethyl ethylphosphonothiolate

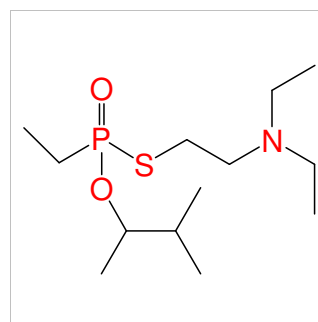

**Chemical name:** 1,2-Dimethylpropyl S-2-dimethylaminoethyl ethylphosphonothiolate

Schedule: 1A03

CAS RN: 1256572-34-5

HS code: 2930.90

Key: 1256572-34-5

Molecular formula: C<sub>11</sub>H<sub>26</sub>NO<sub>2</sub>PS

CAS Index Name: Phosphonothioic acid, ethyl-, S-[2-(dimethylamino)ethyl] O-(1,2-dimethylpropyl) ester

**IUPAC name:** 1,2-Dimethylpropyl S-2-dimethylaminoethyl ethylphosphonothioate

Synonyms: S-[2-(Dimethylamino)ethyl] O-3-methylbut-2-yl ethylphosphonothiolate

O-1,2-Dimethylpropyl S-2-dimethylaminoethyl ethylphosphonothiolate

3-Methylbutan-2-yl S-2-dimethylaminoethyl ethylphosphonothiolate

3-Methylbut-2-yl S-2-dimethylaminoethyl ethylphosphonothiolate

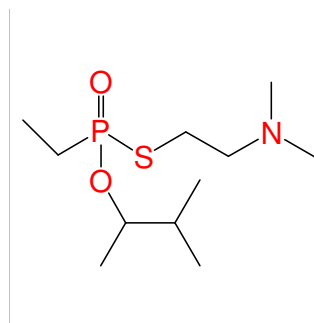

**Chemical name:** 1,2-Dimethylpropyl S-2-dipropylaminoethyl ethylphosphonothiolate

Schedule: 1A03

CAS RN: 1256572-35-6

HS code: 2930.90

Key: 1256572-35-6

Molecular formula: C<sub>15</sub>H<sub>34</sub>NO<sub>2</sub>PS

CAS Index Name: Phosphonothioic acid, ethyl-, S-[2-(dipropylamino)ethyl] O-(1,2-dimethylpropyl) ester

**IUPAC name:** 1,2-Dimethylpropyl S-2-dipropylaminoethyl ethylphosphonothioate

Synonyms: S-[2-(Dipropylamino)ethyl] O-3-methylbut-2-yl ethylphosphonothiolate

O-1,2-Dimethylpropyl S-2-dipropylaminoethyl ethylphosphonothiolate

3-Methylbutan-2-yl S-2-dipropylaminoethyl ethylphosphonothiolate

3-Methylbut-2-yl S-2-dipropylaminoethyl ethylphosphonothiolate

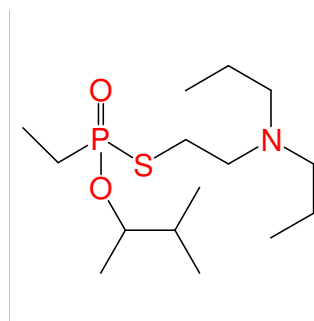

**Chemical name:** 1,2-Dimethylpropyl S-2-diethylaminoethyl methylphosphonothiolate

Schedule: 1A03

CAS RN: 1256572-36-7

HS code: 2930.90

Key: 1256572-36-7

Molecular formula: C<sub>12</sub>H<sub>28</sub>NO<sub>2</sub>PS

CAS Index Name: Phosphonothioic acid, methyl-, S-[2-(diethylamino)ethyl] O-(1,2-dimethylpropyl) ester

**IUPAC name:** 1,2-Dimethylpropyl S-2-diethylaminoethyl methylphosphonothioate

Synonyms: S-[2-(diethylamino)ethyl] O-3-methylbut-2-yl methylphosphonothiolate

O-1,2-Dimethylpropyl S-2-diethylaminoethyl methylphosphonothiolate

3-Methylbutan-2-yl S-2-diethylaminoethyl methylphosphonothiolate

3-Methylbut-2-yl S-2-diethylaminoethyl methylphosphonothiolate

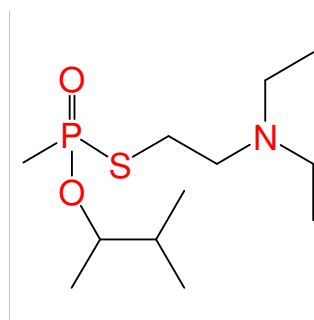

**Chemical name:** 2-Ethylhexyl S-2-dipropylaminoethyl ethylphosphonothiolate

Schedule: 1A03

CAS RN: 1256634-48-6

HS code: 2930.90

Key: 1256634-48-6

Molecular formula: C<sub>18</sub>H<sub>40</sub>NO<sub>2</sub>PS

CAS Index Name: Phosphonothioic acid, P-ethyl-, S-[2-(dipropylamino)ethyl] O-(2-ethylhexyl) ester

**IUPAC name:**

Synonyms:

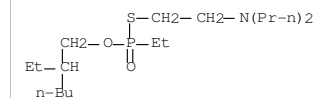

**Chemical name:** 2-Ethylhexyl S-2-diisopropylaminoethyl ethylphosphonothiolate

Schedule: 1A03

CAS RN: 1256634-49-7

HS code: 2930.90

Key: 1256634-49-7

Molecular formula: C<sub>18</sub>H<sub>40</sub>NO<sub>2</sub>PS

CAS Index Name: Phosphonothioic acid, P-ethyl-, S-[2-[bis(1-methylethyl)amino]ethyl] O-(2-ethylhexyl) ester

**IUPAC name:**

Synonyms:

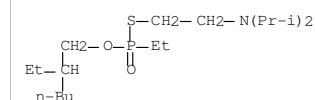

**Chemical name:** 2-Ethylhexyl S-2-dimethylaminoethyl ethylphosphonothiolate

Schedule: 1A03

CAS RN: 1256634-50-0

HS code: 2930.90

Key: 1256634-50-0

Molecular formula: C<sub>14</sub>H<sub>32</sub>NO<sub>2</sub>PS

CAS Index Name: Phosphonothioic acid, P-ethyl-, S-[2-(dimethylamino)ethyl] O-(2-ethylhexyl) ester

**IUPAC name:**

Synonyms:

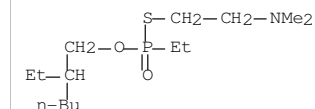

**Chemical name:** Heptyl S-2-dipropylaminoethyl ethylphosphonothiolate

Schedule: 1A03

CAS RN: 1256634-51-1

HS code: 2930.90

Key: 1256634-51-1

Molecular formula: C<sub>17</sub>H<sub>38</sub>NO<sub>2</sub>PS

CAS Index Name: Phosphonothioic acid, ethyl-, S-[2-(dipropylamino)ethyl] O-heptyl ester

**IUPAC name:** Heptyl S-2-dipropylaminoethyl ethylphosphonothioate

Synonyms: O-Heptyl S-2-dipropylaminoethyl ethylphosphonothiolate

Heptyl S-[2-(dipropylamino)ethyl] ethylphosphonothiolate

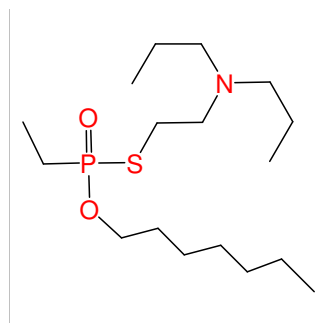

**Chemical name:** 2-Ethylhexyl S-2-diisopropylaminoethyl methylphosphonothiolate

Schedule: 1A03

CAS RN: 1256634-52-2

HS code: 2930.90

Key: 1256634-52-2

Molecular formula: C<sub>17</sub>H<sub>38</sub>NO<sub>2</sub>PS

CAS Index Name: Phosphonothioic acid, P-methyl-, S-[2-[bis(1-methylethyl)amino]ethyl] O-(2-ethylhexyl) ester

**IUPAC name:**

Synonyms:

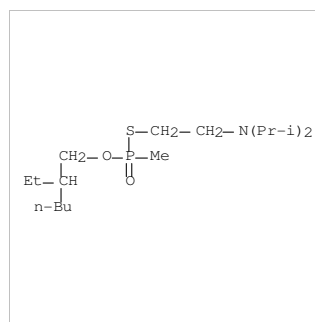

**Chemical name:** Heptyl S-2-dimethylaminoethyl methylphosphonothiolate

Schedule: 1A03

CAS RN: 1256634-53-3

HS code: 2930.90

Key: 1256634-53-3

Molecular formula: C<sub>12</sub>H<sub>28</sub>NO<sub>2</sub>PS

CAS Index Name: Phosphonothioic acid, methyl-, S-[2-(dimethylamino)ethyl] O-heptyl ester

**IUPAC name:** Heptyl S-2-dimethylaminoethyl methylphosphonothioate

Synonyms: O-Heptyl S-2-dimethylaminoethyl methylphosphonothiolate

Heptyl S-[2-(dimethylamino)ethyl] methylphosphonothiolate

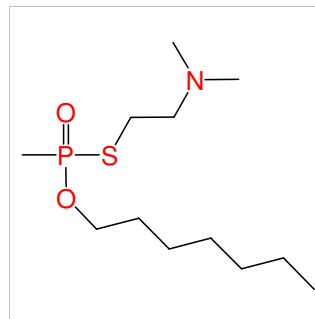

**Chemical name:** Octyl S-2-diisopropylaminoethyl ethylphosphonothiolate

Schedule: 1A03

CAS RN: 1256634-54-4

HS code: 2930.90

Key: 1256634-54-4

Molecular formula: C<sub>18</sub>H<sub>40</sub>NO<sub>2</sub>PS

CAS Index Name: Phosphonothioic acid, ethyl-, S-[2-(bis(1-methylethyl)amino)ethyl] O-octyl ester

**IUPAC name:** Octyl S-2-diisopropylaminoethyl ethylphosphonothioate

Synonyms: Octyl S-[2-(diisopropylamino)ethyl] ethylphosphonothiolate

O-Octyl S-2-diisopropylaminoethyl ethylphosphonothiolate

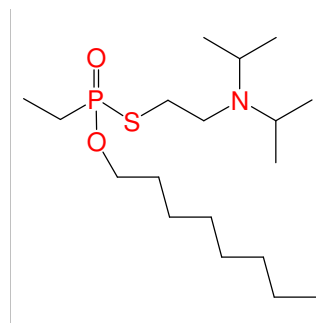

**Chemical name:** Octyl S-2-dipropylaminoethyl ethylphosphonothiolate

Schedule: 1A03

CAS RN: 1256634-55-5

HS code: 2930.90

Key: 1256634-55-5

Molecular formula: C<sub>18</sub>H<sub>40</sub>NO<sub>2</sub>PS

CAS Index Name: Phosphonothioic acid, ethyl-, S-[2-(dipropylamino)ethyl] O-octyl ester

**IUPAC name:** Octyl S-2-dipropylaminoethyl ethylphosphonothioate

Synonyms: Octyl S-[2-(dipropylamino)ethyl] ethylphosphonothiolate

O-Octyl S-2-dipropylaminoethyl ethylphosphonothiolate

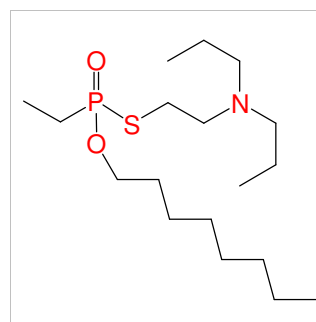

**Chemical name:** Octyl S-2-diethylaminoethyl methylphosphonothiolate

Schedule: 1A03

CAS RN: 1256634-56-6

HS code: 2930.90

Key: 1256634-56-6

Molecular formula: C<sub>15</sub>H<sub>34</sub>NO<sub>2</sub>PS

CAS Index Name: Phosphonothioic acid, methyl-, S-[2-(diethylamino)ethyl] O-octyl ester

**IUPAC name:** Octyl S-2-diethylaminoethyl methylphosphonothioate

Synonyms: Octyl S-[2-(diethylamino)ethyl] methylphosphonothiolate

O-Octyl S-2-diethylaminoethyl methylphosphonothiolate

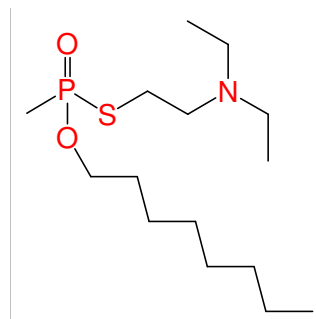

**Chemical name:** Octyl S-2-dimethylaminoethyl ethylphosphonothiolate

Schedule: 1A03

CAS RN: 1256634-57-7

HS code: 2930.90

Key: 1256634-57-7

Molecular formula: C<sub>14</sub>H<sub>32</sub>NO<sub>2</sub>PS

CAS Index Name: Phosphonothioic acid, ethyl-, S-[2-(dimethylamino)ethyl] O-octyl ester

**IUPAC name:** Octyl S-2-dimethylaminoethyl ethylphosphonothioate

Synonyms: O-Octyl S-2-dimethylaminoethyl ethylphosphonothiolate

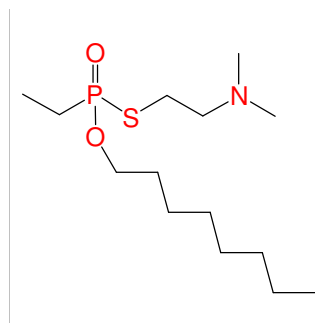

**Chemical name:** Octyl S-2-dipropylaminoethyl methylphosphonothiolate

Schedule: 1A03

CAS RN: 1256634-58-8

HS code: 2930.90

Key: 1256634-58-8

Molecular formula: C<sub>17</sub>H<sub>38</sub>NO<sub>2</sub>PS

CAS Index Name: Phosphonothioic acid, methyl-, S-[2-(dipropylamino)ethyl] O-octyl ester

**IUPAC name:** Octyl S-2-dipropylaminoethyl methylphosphonothioate

Synonyms: Octyl S-[2-(dipropylamino)ethyl] methylphosphonothiolate

O-Octyl S-2-dipropylaminoethyl methylphosphonothiolate

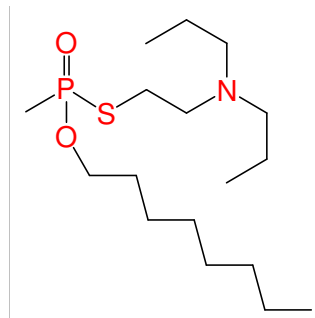

**Chemical name:** Decyl S-2-diisopropylaminoethyl ethylphosphonothiolate

Schedule: 1A03

CAS RN: 1256634-59-9

HS code: 2930.90

Key: 1256634-59-9

Molecular formula: C<sub>20</sub>H<sub>44</sub>NO<sub>2</sub>PS

CAS Index Name: Phosphonothioic acid, ethyl-, S-[2-(bis(1-methylethyl)amino)ethyl] O-decyl ester

**IUPAC name:** Decyl S-2-diisopropylaminoethyl ethylphosphonothioate

Synonyms: O-Decyl S-2-diisopropylaminoethyl ethylphosphonothiolate

Decyl S-[2-(diisopropylamino)ethyl] ethylphosphonothiolate

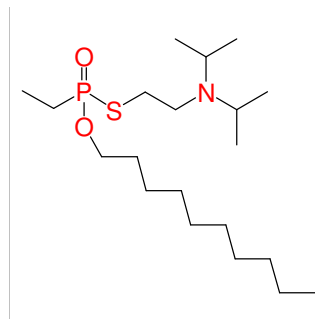



**Chemical name:** Decyl S-2-dimethylaminoethyl ethylphosphonothiolate

Schedule: 1A03

CAS RN: 1256634-60-2

HS code: 2930.90

Key: 1256634-60-2

Molecular formula: C<sub>16</sub>H<sub>36</sub>NO<sub>2</sub>PS

CAS Index Name: Phosphonothioic acid, ethyl-, S-[2-(dimethylamino)ethyl] O-decyl ester

**IUPAC name:** Decyl S-2-dimethylaminoethyl ethylphosphonothioate

Synonyms: O-Decyl S-2-dimethylaminoethyl ethylphosphonothiolate

Decyl S-[2-(dimethylamino)ethyl] ethylphosphonothiolate

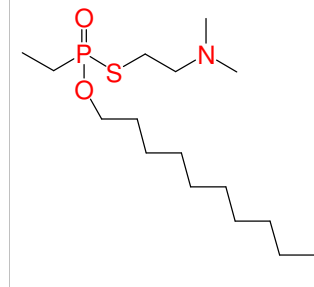

**Chemical name:** Decyl S-2-dipropylaminoethyl ethylphosphonothiolate

Schedule: 1A03

CAS RN: 1256634-61-3

HS code: 2930.90

Key: 1256634-61-3

Molecular formula: C<sub>20</sub>H<sub>44</sub>NO<sub>2</sub>PS

CAS Index Name: Phosphonothioic acid, ethyl-, S-[2-(dipropylamino)ethyl] O-decyl ester

**IUPAC name:** Decyl S-2-dipropylaminoethyl ethylphosphonothioate

Synonyms: O-Decyl S-2-dipropylaminoethyl ethylphosphonothiolate

Decyl S-[2-(dipropylamino)ethyl] ethylphosphonothiolate

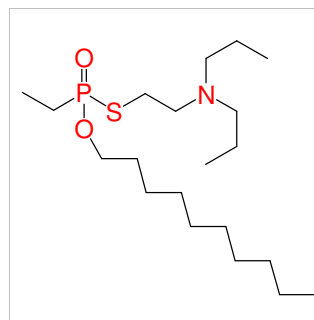

**Chemical name:** Decyl S-2-diisopropylaminoethyl methylphosphonothiolate

Schedule: 1A03

CAS RN: 1256634-62-4

HS code: 2930.90

Key: 1256634-62-4

Molecular formula: C<sub>19</sub>H<sub>42</sub>NO<sub>2</sub>PS

CAS Index Name: Phosphonothioic acid, methyl-, S-[2-(bis(1-methylethyl)amino)ethyl] O-decyl ester

**IUPAC name:** Decyl S-2-diisopropylaminoethyl methylphosphonothioate

Synonyms: O-Decyl S-2-diisopropylaminoethyl methylphosphonothiolate

Decyl S-[2-[bis-(1-methylethyl)amino]-ethyl] methylphosphonothiolate

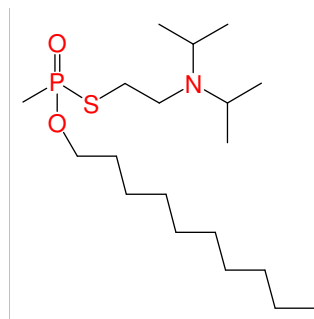

**Chemical name:** Decyl S-2-dipropylaminoethyl methylphosphonothiolate

Schedule: 1A03

CAS RN: 1256634-63-5

HS code: 2930.90

Key: 1256634-63-5

Molecular formula: C<sub>19</sub>H<sub>42</sub>NO<sub>2</sub>PS

CAS Index Name: Phosphonothioic acid, methyl-, S-[2-(dipropylamino)ethyl] O-decyl ester

**IUPAC name:** Decyl S-2-dipropylaminoethyl methylphosphonothioate

Synonyms: O-Decyl S-2-dipropylaminoethyl methylphosphonothiolate

Decyl S-[2-(dipropylamino)ethyl] methylphosphonothiolate

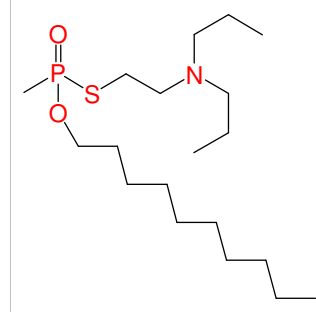

**Chemical name:** 3-Methylbutyl S-2-diisopropylaminoethyl ethylphosphonothiolate

Schedule: 1A03

CAS RN: 1256634-64-6

HS code: 2930.90

Key: 1256634-64-6

Molecular formula: C<sub>15</sub>H<sub>34</sub>NO<sub>2</sub>PS

CAS Index Name: Phosphonothioic acid, ethyl-, S-[2-(bis(1-methylethyl)amino)ethyl] O-(3-methylbutyl) ester

**IUPAC name:** 3-Methylbutyl S-2-diisopropylaminoethyl ethylphosphonothioate

Synonyms: O-Isopentyl S-2-diisopropylaminoethyl ethylphosphonothiolate

O-3-Methylbutyl S-2-diisopropylaminoethyl ethylphosphonothiolate

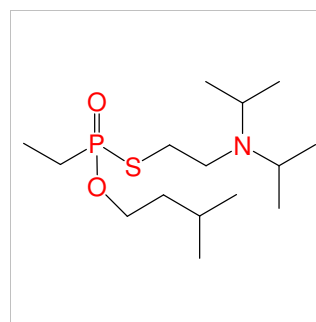

**Chemical name:** 3-Methylbutyl S-2-dimethylaminoethyl ethylphosphonothiolate

Schedule: 1A03

CAS RN: 1256634-65-7

HS code: 2930.90

Key: 1256634-65-7

Molecular formula: C<sub>11</sub>H<sub>26</sub>NO<sub>2</sub>PS

CAS Index Name: Phosphonothioic acid, ethyl-, S-[2-(dimethylamino)ethyl] O-(3-methylbutyl) ester

**IUPAC name:** 3-Methylbutyl S-2-dimethylaminoethyl ethylphosphonothioate

Synonyms: O-3-Methylbutyl S-2-dimethylaminoethyl ethylphosphonothiolate

Isopentyl S-2-dimethylaminoethyl ethylphosphonothiolate

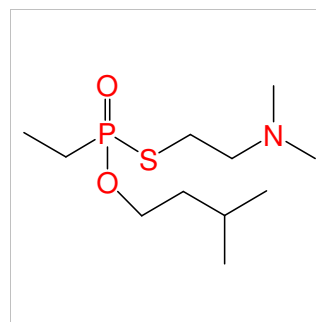

**Chemical name:** 3-Methylbutyl S-2-diisopropylaminoethyl methylphosphonothiolate

Schedule: 1A03

CAS RN: 1256634-66-8

HS code: 2930.90

Key: 1256634-66-8

Molecular formula: C<sub>14</sub>H<sub>32</sub>NO<sub>2</sub>PS

CAS Index Name: Phosphonothioic acid, methyl-, S-[2-(bis(1-methylethyl)amino)ethyl] O-(3-methylbutyl) ester

**IUPAC name:** 3-Methylbutyl S-2-diisopropylaminoethyl methylphosphonothioate

Synonyms: O-3-Methylbutyl S-2-diisopropylaminoethyl methylphosphonothiolate  
Isopentyl S-2-diisopropylaminoethyl methylphosphonothiolate

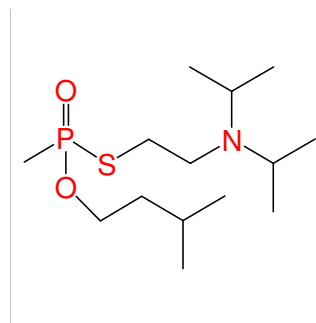

**Chemical name:** 3-Methylbutyl S-2-dimethylaminoethyl methylphosphonothiolate

Schedule: 1A03

CAS RN: 1256634-67-9

HS code: 2930.90

Key: 1256634-67-9

Molecular formula: C<sub>10</sub>H<sub>24</sub>NO<sub>2</sub>PS

CAS Index Name: Phosphonothioic acid, methyl-, S-[2-(dimethylamino)ethyl] O-(3-methylbutyl) ester

**IUPAC name:** 3-Methylbutyl S-2-dimethylaminoethyl methylphosphonothiolate

Synonyms: O-3-Methylbutyl S-2-dimethylaminoethyl methylphosphonothiolate  
Isopentyl S-2-dimethylaminoethyl methylphosphonothiolate

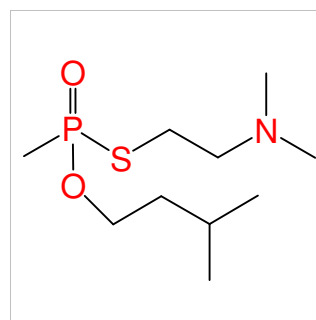

**Chemical name:** 2-Methylbutyl S-2-diethylaminoethyl ethylphosphonothiolate

Schedule: 1A03

CAS RN: 1256634-68-0

HS code: 2930.90

Key: 1256634-68-0

Molecular formula: C<sub>13</sub>H<sub>30</sub>NO<sub>2</sub>PS

CAS Index Name: Phosphonothioic acid, ethyl-, S-[2-(diethylamino)ethyl] O-(2-methylbutyl) ester

**IUPAC name:** 2-Methylbutyl S-2-diethylaminoethyl ethylphosphonothioate

Synonyms: Phosphonothioic acid, ethyl-, S-[2-(diethylamino)ethyl] O-(2-methylbutyl) ester  
O-2-Methylbutyl S-2-diethylaminoethyl ethylphosphonothiolate

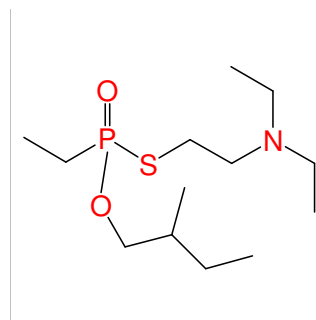

**Chemical name:** 2-Methylbutyl S-2-diisopropylaminoethyl ethylphosphonothiolate

Schedule: 1A03

CAS RN: 1256634-69-1

HS code: 2930.90

Key: 1256634-69-1

Molecular formula: C<sub>15</sub>H<sub>34</sub>NO<sub>2</sub>PS

CAS Index Name: Phosphonothioic acid, ethyl-, S-[2-(bis(1-methylethyl)amino)ethyl] O-(2-methylbutyl) ester

**IUPAC name:** 2-Methylbutyl S-2-diisopropylaminoethyl ethylphosphonothioate

Synonyms: Phosphonothioic acid, ethyl-, S-[2-(bis(1-methylethyl)amino)ethyl] O-(2-methylbutyl) ester  
O-2-Methylbutyl S-2-diisopropylaminoethyl ethylphosphonothiolate

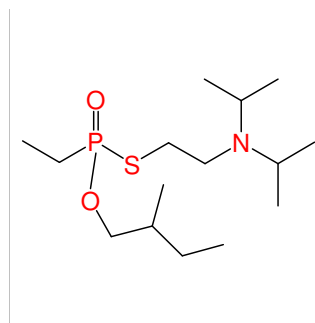

**Chemical name:** 2-Methylbutyl S-2-dimethylaminoethyl ethylphosphonothiolate

Schedule: 1A03

CAS RN: 1256634-70-4

HS code: 2930.90

Key: 1256634-70-4

Molecular formula: C<sub>11</sub>H<sub>26</sub>NO<sub>2</sub>PS

CAS Index Name: Phosphonothioic acid, ethyl-, S-[2-(dimethylamino)ethyl] O-(2-methylbutyl) ester

**IUPAC name:** 2-Methylbutyl S-2-dimethylaminoethyl ethylphosphonothioate

Synonyms: S-[2-(Dimethylamino)ethyl] O-(2-methylbutyl) ethylphosphonothiolate  
Phosphonothioic acid, ethyl-, S-[2-(dimethylamino)ethyl] O-(2-methylbutyl) ester  
O-2-Methylbutyl S-2-dimethylaminoethyl ethylphosphonothiolate

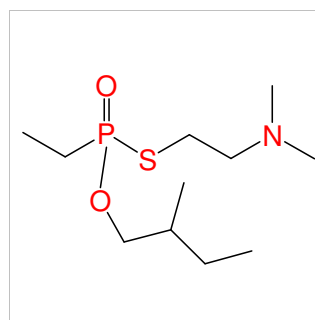

**Chemical name:** 2-Methylbutyl S-2-diethylaminoethyl methylphosphonothiolate

Schedule: 1A03

CAS RN: 1256634-71-5

HS code: 2930.90

Key: 1256634-71-5

Molecular formula: C<sub>12</sub>H<sub>28</sub>NO<sub>2</sub>PS

CAS Index Name: Phosphonothioic acid, methyl-, S-[2-(diethylamino)ethyl] O-(2-methylbutyl) ester

**IUPAC name:** 2-Methylbutyl S-2-diethylaminoethyl methylphosphonothioate

Synonyms: S-[2-(Diethylamino)ethyl] O-(2-methylbutyl) methylphosphonothioate  
O-2-Methylbutyl S-2-diethylaminoethyl methylphosphonothiolate

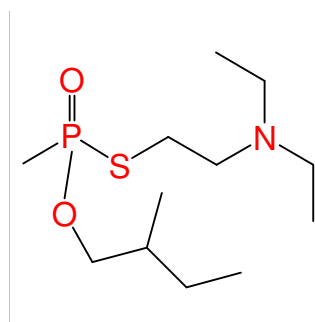

**Chemical name:** 2-Methylbutyl S-2-dimethylaminoethyl methylphosphonothiolate

Schedule: 1A03

CAS RN: 1256634-72-6

HS code: 2930.90

Key: 1256634-72-6

Molecular formula: C<sub>10</sub>H<sub>24</sub>NO<sub>2</sub>PS

CAS Index Name: Phosphonothioic acid, methyl-, S-[2-(dimethylamino)ethyl] O-(2-methylbutyl) ester

**IUPAC name:** 2-Methylbutyl S-2-dimethylaminoethyl methylphosphonothioate

Synonyms: Phosphonothioic acid, methyl-, S-[2-(dimethylamino)ethyl] O-2-methylbutyl ester  
O-2-Methylbutyl S-2-dimethylaminoethyl methylphosphonothiolate

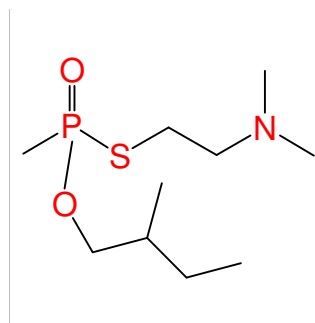

**Chemical name:** Nonyl S-2-diisopropylaminoethyl ethylphosphonothiolate

Schedule: 1A03

CAS RN: 1256634-73-7

HS code: 2930.90

Key: 1256634-73-7

Molecular formula: C<sub>19</sub>H<sub>42</sub>NO<sub>2</sub>PS

CAS Index Name: Phosphonothioic acid, ethyl-, S-[2-(bis(1-methylethyl)amino)ethyl] O-nonyl ester

**IUPAC name:** Nonyl S-2-diisopropylaminoethyl ethylphosphonothioate

Synonyms: Phosphonothioic acid, ethyl-, S-[2-(diisopropylamino)ethyl] O-nonyl ester  
O-Nonyl S-2-diisopropylaminoethyl ethylphosphonothiolate  
Nonyl S-[2-(diisopropylamino)ethyl] ethylphosphonothiolate

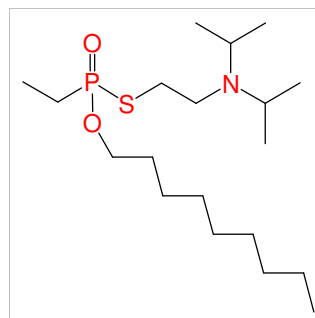

**Chemical name:** Nonyl S-2-dimethylaminoethyl ethylphosphonothiolate

Schedule: 1A03

CAS RN: 1256634-74-8

HS code: 2930.90

Key: 1256634-74-8

Molecular formula: C<sub>15</sub>H<sub>34</sub>NO<sub>2</sub>PS

CAS Index Name: Phosphonothioic acid, ethyl-, S-[2-(dimethylamino)ethyl] O-nonyl ester

**IUPAC name:** Nonyl S-2-dimethylaminoethyl ethylphosphonothioate

Synonyms: O-Nonyl S-2-dimethylaminoethyl ethylphosphonothiolate  
Nonyl S-[2-(dimethylamino)ethyl] ethylphosphonothiolate

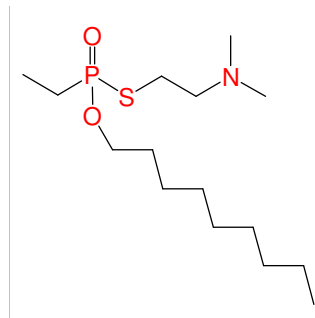

**Chemical name:** 2-Methylbutyl S-2-diisopropylaminoethyl methylphosphonothiolate

Schedule: 1A03

CAS RN: 1256635-47-8

HS code: 2930.90

Key: 1256635-47-8

Molecular formula: C<sub>14</sub>H<sub>32</sub>NO<sub>2</sub>PS

CAS Index Name: Phosphonothioic acid, methyl-, S-[2-(bis(1-methylethyl)amino)ethyl] O-(2-methylbutyl) ester

**IUPAC name:** 2-Methylbutyl S-2-diisopropylaminoethyl methylphosphonothioate

Synonyms: Phosphonothioic acid, methyl-, S-[2-(bis(1-methylethyl)amino)ethyl] O-2-methylbutyl  
O-2-Methylbutyl S-2-diisopropylaminoethyl methylphosphonothiolate

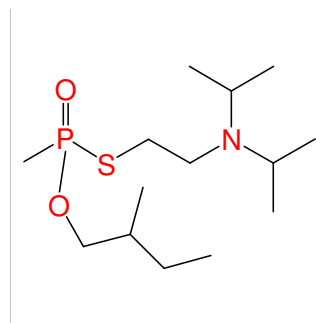

**Chemical name:** Ethyl-d<sub>5</sub> S-2-diisopropylaminoethyl methylphosphonothiolate

Schedule: 1A03

CAS RN: 1276665-26-9

HS code: 2845.90

Key: 1276665-26-9

Molecular formula: C<sub>11</sub>H<sub>21</sub>D<sub>5</sub>NO<sub>2</sub>PS

CAS Index Name: Phosphonothioic acid, P-methyl-, S-[2-[bis(1-methylethyl)amino]ethyl] O-(ethyl-1,1,2,2,2-d<sub>5</sub>) ester

**IUPAC name:** Ethyl-d<sub>5</sub> S-2-diisopropylaminoethyl methylphosphonothioate

Synonyms: O-Pentadeuterioethyl S-2-diisopropylaminoethyl methylphosphonothiolate  
O-Ethyl-d<sub>5</sub> S-2-diisopropylaminoethyl methylphosphonothiolate

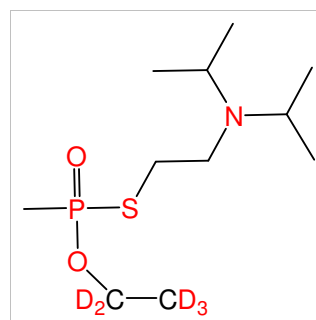

**Chemical name:** Hexyl S-2-dipropylaminoethyl methylphosphonothiolate

Schedule: 1A03

CAS RN: 1280105-80-7

HS code: 2930.90

Key: 1280105-80-7

Molecular formula: C<sub>15</sub>H<sub>34</sub>NO<sub>2</sub>PS

CAS Index Name: Phosphonothioic acid, methyl-, S-[2-(dipropylamino)ethyl] O-hexyl ester

**IUPAC name:** Hexyl S-2-dipropylaminoethyl methylphosphonothioate

Synonyms: O-Hexyl S-2-dipropylaminoethyl methylphosphonothiolate  
Hexyl S-[2-(dipropylamino)ethyl] methylphosphonothiolate

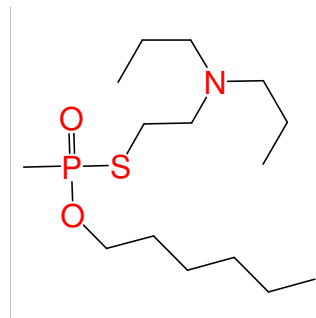

**Chemical name:** Heptyl S-2-dipropylaminoethyl methylphosphonothiolate

Schedule: 1A03

CAS RN: 1280105-83-0

HS code: 2930.90

Key: 1280105-83-0

Molecular formula: C<sub>16</sub>H<sub>36</sub>NO<sub>2</sub>PS

CAS Index Name: Phosphonothioic acid, methyl-, S-[2-(dipropylamino)ethyl] O-heptyl ester

**IUPAC name:** Heptyl S-2-dipropylaminoethyl methylphosphonothioate

Synonyms: O-Heptyl S-2-dipropylaminoethyl methylphosphonothiolate

Heptyl S-[2-(dipropylamino)ethyl] methylphosphonothiolate

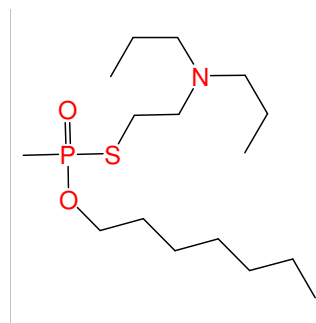

**Chemical name:** Octyl S-2-diisopropylaminoethyl methylphosphonothiolate

Schedule: 1A03

CAS RN: 1280105-84-1

HS code: 2930.90

Key: 1280105-84-1

Molecular formula: C<sub>17</sub>H<sub>38</sub>NO<sub>2</sub>PS

CAS Index Name: Phosphonothioic acid, methyl-, S-[2-(bis(1-methylethyl)amino)ethyl] O-octyl ester

**IUPAC name:** Octyl S-2-diisopropylaminoethyl methylphosphonothioate

Synonyms: Octyl S-[2-[bis-(1-methylethyl)amino]ethyl] methylphosphonothiolate

O-Octyl S-2-diisopropylaminoethyl methylphosphonothiolate

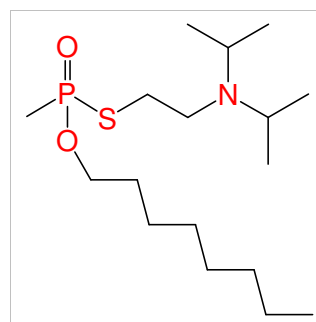

**Chemical name:** 2-Methylpentyl S-2-dipropylaminoethyl ethylphosphonothiolate

Schedule: 1A03

CAS RN: 1280105-87-4

HS code: 2930.90

Key: 1280105-87-4

Molecular formula: C<sub>16</sub>H<sub>36</sub>NO<sub>2</sub>PS

CAS Index Name: Phosphonothioic acid, ethyl-, S-[2-(dipropylamino)ethyl] O-(2-methylpentyl) ester

**IUPAC name:** 2-Methylpentyl S-2-dipropylaminoethyl ethylphosphonothioate

Synonyms: O-2-Methylpentyl S-2-dipropylaminoethyl ethylphosphonothiolate

2-Methylpentyl S-[2-(dipropylamino)ethyl] ethylphosphonothiolate

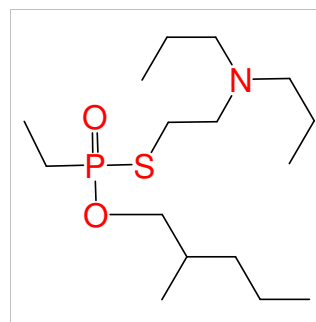

**Chemical name:** 1-Ethylpropyl S-2-dipropylaminoethyl ethylphosphonothiolate

Schedule: 1A03

CAS RN: 1280105-88-5

HS code: 2930.90

Key: 1280105-88-5

Molecular formula: C<sub>15</sub>H<sub>34</sub>NO<sub>2</sub>PS

CAS Index Name: Phosphonothioic acid, ethyl-, S-[2-(dipropylamino)ethyl] O-(1-ethylpropyl) ester

**IUPAC name:** 1-Ethylpropyl S-2-dipropylaminoethyl ethylphosphonothioate

Synonyms: S-[2-(dipropylamino)ethyl] O-pent-3-yl ethylphosphonothiolate

Phosphonothioic acid, ethyl-, S-[2-(dipropylamino)ethyl] O-pent-3-yl ester

Phosphonothioic acid, ethyl-, S-[2-(dipropylamino)ethyl] O-(1-ethylpropyl) ester

Pentan-3-yl S-2-dipropylaminoethyl ethylphosphonothiolate

Pent-3-yl S-2-dipropylaminoethyl ethylphosphonothiolate

O-1-Ethylpropyl S-2-dipropylaminoethyl ethylphosphonothiolate

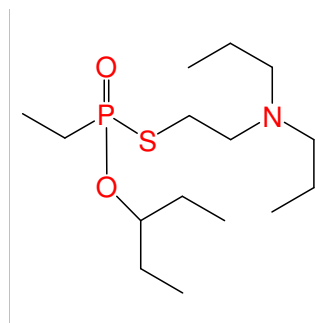

**Chemical name:** 1-Ethylpropyl S-2-dimethylaminoethyl methylphosphonothiolate

Schedule: 1A03

CAS RN: 1280105-90-9

HS code: 2930.90

Key: 1280105-90-9

Molecular formula: C<sub>10</sub>H<sub>24</sub>NO<sub>2</sub>PS

CAS Index Name: Phosphonothioic acid, methyl-, S-[2-(dimethylamino)ethyl] O-(1-ethylpropyl) ester

**IUPAC name:** 1-Ethylpropyl S-2-dimethylaminoethyl methylphosphonothioate

Synonyms: S-[2-(dimethylamino)ethyl] O-pent-3-yl methylphosphonothiolate

Phosphonothioic acid, methyl-, S-[2-(dimethylamino)ethyl] O-(1-ethylpropyl) ester

Pentan-3-yl S-2-dimethylaminoethyl methylphosphonothiolate

Pent-3-yl S-2-dimethylaminoethyl methylphosphonothiolate

O-1-Ethylpropyl S-2-dimethylaminoethyl methylphosphonothiolate

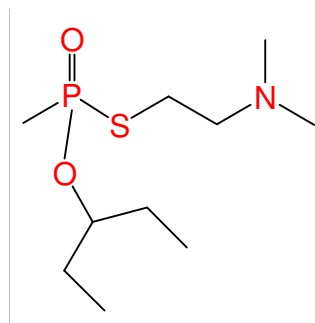



**Chemical name:** 1,2-Dimethylpropyl S-2-diisopropylaminoethyl ethylphosphonothiolate

Schedule: 1A03

CAS RN: 1280105-92-1

HS code: 2930.90

Key: 1280105-92-1

Molecular formula: C<sub>15</sub>H<sub>34</sub>NO<sub>2</sub>PS

CAS Index Name: Phosphonothioic acid, ethyl-, S-[2-(bis(1-methylethyl)amino)ethyl] O-(1,2-dimethylpropyl) ester

**IUPAC name:** 1,2-Dimethylpropyl S-2-diisopropylaminoethyl ethylphosphonothioate

Synonyms: S-[2-(Diisopropylamino)ethyl] O-3-methylbut-2-yl ethylphosphonothiolate

O-1,2-Dimethylpropyl S-2-diisopropylaminoethyl ethylphosphonothiolate

3-Methylbutan-2-yl S-2-diisopropylaminoethyl ethylphosphonothiolate

3-Methylbut-2-yl S-2-diisopropylaminoethyl ethylphosphonothiolate

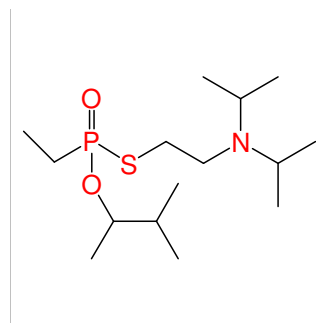

**Chemical name:** 1,2-Dimethylpropyl S-2-dimethylaminoethyl methylphosphonothiolate

Schedule: 1A03

CAS RN: 1280105-93-2

HS code: 2930.90

Key: 1280105-93-2

Molecular formula: C<sub>10</sub>H<sub>24</sub>NO<sub>2</sub>PS

CAS Index Name: Phosphonothioic acid, methyl-, S-[2-(dimethylamino)ethyl] O-(1,2-dimethylpropyl) ester

**IUPAC name:** 1,2-Dimethylpropyl S-2-dimethylaminoethyl methylphosphonothioate

Synonyms: S-[2-(dimethylamino)ethyl] O-3-methylbut-2-yl methylphosphonothiolate

O-1,2-Dimethylpropyl S-2-dimethylaminoethyl methylphosphonothiolate

3-Methylbutan-2-yl S-2-dimethylaminoethyl methylphosphonothiolate

3-Methylbut-2-yl S-2-dimethylaminoethyl methylphosphonothiolate

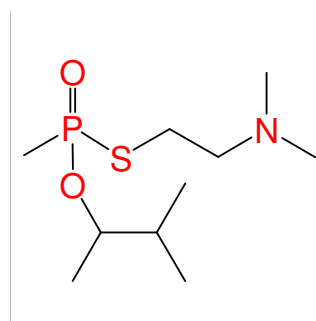

**Chemical name:** 1-Methylbutyl S-2-diisopropylaminoethyl ethylphosphonothiolate

Schedule: 1A03

CAS RN: 1280105-94-3

HS code: 2930.90

Key: 1280105-94-3

Molecular formula: C<sub>15</sub>H<sub>34</sub>NO<sub>2</sub>PS

CAS Index Name: Phosphonothioic acid, ethyl-, S-[2-(bis(1-methylethyl)amino)ethyl] O-(1-methylbutyl) ester

**IUPAC name:** 1-Methylbutyl S-2-diisopropylaminoethyl ethylphosphonothioate

Synonyms: S-[2-(Diisopropylamino)ethyl] O-pent-2-yl ethylphosphonothiolate

Pentan-2-yl S-2-diisopropylaminoethyl ethylphosphonothiolate

Pent-2-yl S-2-diisopropylaminoethyl ethylphosphonothiolate

O-1-Methylbutyl S-2-diisopropylaminoethyl ethylphosphonothiolate

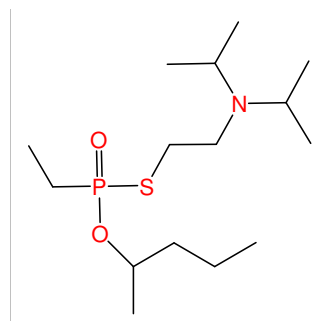

**Chemical name:** 1-Methylbutyl S-2-diisopropylaminoethyl methylphosphonothiolate

Schedule: 1A03

CAS RN: 1280105-95-4

HS code: 2930.90

Key: 1280105-95-4

Molecular formula: C<sub>14</sub>H<sub>32</sub>NO<sub>2</sub>PS

CAS Index Name: Phosphonothioic acid, methyl-, S-[2-(bis(1-methylethyl)amino)ethyl] O-(1-methylbutyl) ester

**IUPAC name:** 1-Methylbutyl S-2-diisopropylaminoethyl methylphosphonothioate

Synonyms: S-[2-(Diisopropylamino)ethyl] O-pent-2-yl methylphosphonothiolate

Phosphonothioic acid, methyl-, S-[2-(bis(1-methylethyl)amino)ethyl] O-pent-2-yl ester

Pentan-2-yl S-2-diisopropylaminoethyl methylphosphonothiolate

Pent-2-yl S-2-diisopropylaminoethyl methylphosphonothiolate

O-1-Methylbutyl S-2-diisopropylaminoethyl methylphosphonothiolate

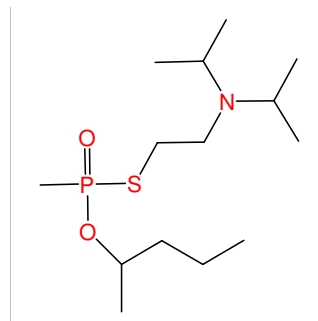

**Chemical name:** 1-Ethylbutyl S-2-diethylaminoethyl ethylphosphonothiolate

Schedule: 1A03

CAS RN: 1280105-96-5

HS code: 2930.90

Key: 1280105-96-5

Molecular formula: C<sub>14</sub>H<sub>32</sub>NO<sub>2</sub>PS

CAS Index Name: Phosphonothioic acid, ethyl-, S-[2-(diethylamino)ethyl] O-(1-ethylbutyl) ester

**IUPAC name:** 1-Ethylbutyl S-2-diethylaminoethyl ethylphosphonothioate

Synonyms: Phosphonothioic acid, ethyl-, S-[2-(diethylamino)ethyl] O-hex-3-yl ester

O-1-Ethylbutyl S-2-diethylaminoethyl ethylphosphonothiolate

Hexan-3-yl S-2-diethylaminoethyl ethylphosphonothiolate

Hex-3-yl S-2-diethylaminoethyl ethylphosphonothiolate

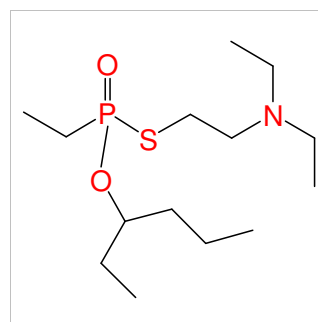

**Chemical name:** 1-Ethylbutyl S-2-diisopropylaminoethyl ethylphosphonothiolate

Schedule: 1A03

CAS RN: 1280105-97-6 HS code: 2930.90

Key: 1280105-97-6

Molecular formula: C<sub>16</sub>H<sub>36</sub>NO<sub>2</sub>PS

CAS Index Name: Phosphonothioic acid, ethyl-, S-[2-(bis(1-methylethyl)amino)ethyl] O-(1-ethylbutyl) ester

**IUPAC name:** 1-Ethylbutyl S-2-diisopropylaminoethyl ethylphosphonothioate

Synonyms: Phosphonothioic acid, ethyl-, S-[2-(bis(1-methylethyl)amino)ethyl] O-hex-3-yl ester  
O-1-Ethylbutyl S-2-diisopropylaminoethyl ethylphosphonothiolate  
Hexan-3-yl S-2-diisopropylaminoethyl ethylphosphonothiolate  
Hex-3-yl S-2-diisopropylaminoethyl ethylphosphonothiolate

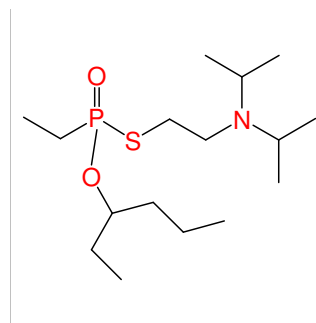

**Chemical name:** 1-Ethylbutyl S-2-dimethylaminoethyl ethylphosphonothiolate

Schedule: 1A03

CAS RN: 1280105-98-7 HS code: 2930.90

Key: 1280105-98-7

Molecular formula: C<sub>12</sub>H<sub>28</sub>NO<sub>2</sub>PS

CAS Index Name: Phosphonothioic acid, ethyl-, S-[2-(dimethylamino)ethyl] O-(1-ethylbutyl) ester

**IUPAC name:** 1-Ethylbutyl S-2-dimethylaminoethyl ethylphosphonothioate

Synonyms: Phosphonothioic acid, ethyl-, S-[2-(dimethylamino)ethyl] O-hex-3-yl ester  
O-1-Ethylbutyl S-2-dimethylaminoethyl ethylphosphonothiolate  
Hexan-3-yl S-2-dimethylaminoethyl ethylphosphonothiolate  
Hex-3-yl S-2-dimethylaminoethyl ethylphosphonothiolate

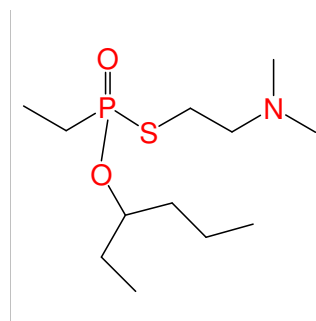

**Chemical name:** 1-Ethylbutyl S-2-dipropylaminoethyl ethylphosphonothiolate

Schedule: 1A03

CAS RN: 1280105-99-8 HS code: 2930.90

Key: 1280105-99-8

Molecular formula: C<sub>16</sub>H<sub>36</sub>NO<sub>2</sub>PS

CAS Index Name: Phosphonothioic acid, ethyl-, S-[2-(dipropylamino)ethyl] O-(1-ethylbutyl) ester

**IUPAC name:** 1-Ethylbutyl S-2-dipropylaminoethyl ethylphosphonothioate

Synonyms: Phosphonothioic acid, ethyl-, S-[2-(dipropylamino)ethyl] O-hex-3-yl ester  
O-1-Ethylbutyl S-2-dipropylaminoethyl ethylphosphonothiolate  
Hexan-3-yl S-2-dipropylaminoethyl ethylphosphonothiolate  
Hex-3-yl S-2-dipropylaminoethyl ethylphosphonothiolate

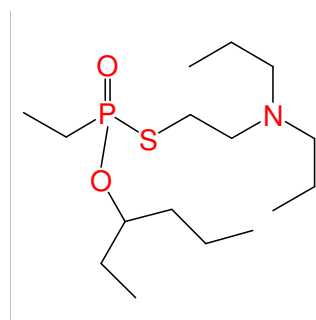

**Chemical name:** 1-Ethylbutyl S-2-diethylaminoethyl methylphosphonothiolate

Schedule: 1A03

CAS RN: 1280106-01-5

HS code: 2930.90

Key: 1280106-01-5

Molecular formula: C<sub>13</sub>H<sub>30</sub>NO<sub>2</sub>PS

CAS Index Name: Phosphonothioic acid, methyl-, S-[2-(diethylamino)ethyl] O-(1-ethylbutyl) ester

**IUPAC name:** 1-Ethylbutyl S-2-diethylaminoethyl methylphosphonothioate

Synonyms: Phosphonothioic acid, methyl-, S-[2-(diethylamino)ethyl] O-hex-3-yl ester

O-1-Ethylbutyl S-2-diethylaminoethyl methylphosphonothiolate

Hexan-3-yl S-2-diethylaminoethyl methylphosphonothiolate

Hex-3-yl S-2-diethylaminoethyl methylphosphonothiolate

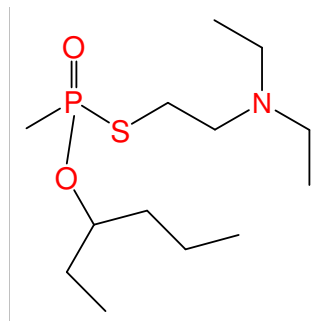

**Chemical name:** 1-Ethylbutyl S-2-diisopropylaminoethyl methylphosphonothiolate

Schedule: 1A03

CAS RN: 1280106-04-8

HS code: 2930.90

Key: 1280106-04-8

Molecular formula: C<sub>15</sub>H<sub>34</sub>NO<sub>2</sub>PS

CAS Index Name: Phosphonothioic acid, methyl-, S-[2-(bis(1-methylethyl)amino)ethyl] O-(1-ethylbutyl) ester

**IUPAC name:** 1-Ethylbutyl S-2-diisopropylaminoethyl methylphosphonothioate

Synonyms: Phosphonothioic acid, methyl-, S-[2-(bis(1-methylethyl)amino)ethyl] O-hex-3-yl ester

O-1-Ethylbutyl S-2-diisopropylaminoethyl methylphosphonothiolate

Hexan-3-yl S-2-diisopropylaminoethyl methylphosphonothiolate

Hex-3-yl S-2-diisopropylaminoethyl methylphosphonothiolate

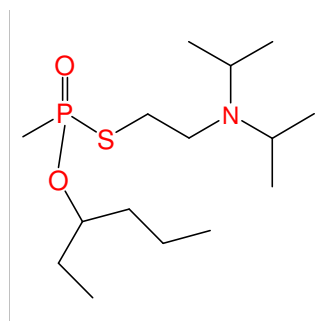

**Chemical name:** 1-Ethylbutyl S-2-dimethylaminoethyl methylphosphonothiolate

Schedule: 1A03

CAS RN: 1280106-06-0

HS code: 2930.90

Key: 1280106-06-0

Molecular formula: C<sub>11</sub>H<sub>26</sub>NO<sub>2</sub>PS

CAS Index Name: Phosphonothioic acid, methyl-, S-[2-(dimethylamino)ethyl] O-(1-ethylbutyl) ester

**IUPAC name:** 1-Ethylbutyl S-2-dimethylaminoethyl methylphosphonothioate

Synonyms: Phosphonothioic acid, methyl-, S-[2-(dimethylamino)ethyl] O-hex-3-yl ester

O-1-Ethylbutyl S-2-dimethylaminoethyl methylphosphonothiolate

Hexan-3-yl S-2-dimethylaminoethyl methylphosphonothiolate

Hex-3-yl S-2-dimethylaminoethyl methylphosphonothiolate

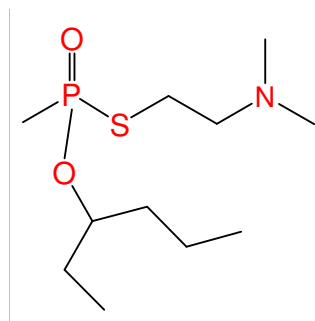

**Chemical name:** Cyclohexyl S-2-dipropylaminoethyl ethylphosphonothiolate

Schedule: 1A03

CAS RN: 1280106-23-1

HS code: 2930.90

Key: 1280106-23-1

Molecular formula: C<sub>16</sub>H<sub>34</sub>NO<sub>2</sub>PS

CAS Index Name: Phosphonothioic acid, ethyl-, S-[2-(dipropylamino)ethyl] O-cyclohexyl ester

**IUPAC name:** Cyclohexyl S-2-dipropylaminoethyl ethylphosphonothioate

Synonyms: O-Cyclohexyl S-2-dipropylaminoethyl ethylphosphonothiolate

Cyclohexyl S-[2-(dipropylamino)ethyl] ethylphosphonothiolate

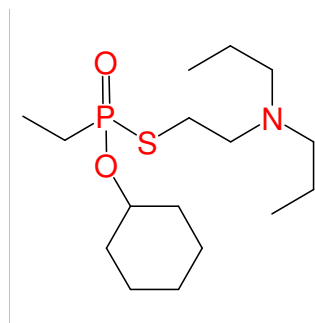

**Chemical name:** Hexyl S-2-diisopropylaminoethyl ethylphosphonothiolate

Schedule: 1A03

CAS RN: 1280106-24-2

HS code: 2930.90

Key: 1280106-24-2

Molecular formula: C<sub>16</sub>H<sub>36</sub>NO<sub>2</sub>PS

CAS Index Name: Phosphonothioic acid, ethyl-, S-[2-(bis(1-methylethyl)amino)ethyl] O-hexyl ester

**IUPAC name:** Hexyl S-2-diisopropylaminoethyl ethylphosphonothioate

Synonyms: O-Hexyl S-2-diisopropylaminoethyl ethylphosphonothiolate

Hexyl S-[2-[bis(1-methylethyl)amino]ethyl] ethylphosphonothiolate

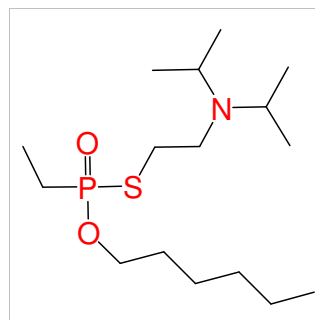

**Chemical name:** 1-Methylpentyl S-2-diisopropylaminoethyl ethylphosphonothiolate

Schedule: 1A03

CAS RN: 1281955-43-8

HS code: 2930.90

Key: 1281955-43-8

Molecular formula: C<sub>16</sub>H<sub>36</sub>NO<sub>2</sub>PS

CAS Index Name: Phosphonothioic acid, ethyl-, S-[2-(bis(1-methylethyl)amino)ethyl] O-(1-methylpentyl) ester

**IUPAC name:** 1-Methylpentyl S-2-diisopropylaminoethyl ethylphosphonothioate

Synonyms: Phosphonothioic acid, ethyl-, S-[2-(bis(1-methylethyl)amino)ethyl] O-hex-2-yl ester

Phosphonothioic acid, ethyl-, S-[2-(bis(1-methylethyl)amino)ethyl] O-(1-methylpentyl)

O-1-Methylpentyl S-2-diisopropylaminoethyl ethylphosphonothiolate

Hexan-2-yl S-2-diisopropylaminoethyl ethylphosphonothiolate

Hex-2-yl S-2-diisopropylaminoethyl ethylphosphonothiolate

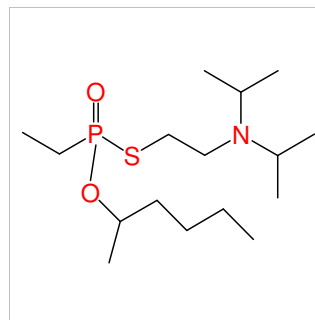

**Chemical name:** 1-Methylpentyl S-2-dipropylaminoethyl ethylphosphonothiolate

Schedule: 1A03

CAS RN: 1281955-45-0

HS code: 2930.90

Key: 1281955-45-0

Molecular formula: C<sub>16</sub>H<sub>36</sub>NO<sub>2</sub>PS

CAS Index Name: Phosphonothioic acid, ethyl-, S-[2-(dipropylamino)ethyl] O-(1-methylpentyl) ester

**IUPAC name:** 1-Methylpentyl S-2-dipropylaminoethyl ethylphosphonothioate

Synonyms: Phosphonothioic acid, ethyl-, S-[2-(dipropylamino)ethyl] O-hex-2-yl ester

O-1-Methylpentyl S-2-dipropylaminoethyl ethylphosphonothiolate

Hexan-2-yl S-2-dipropylaminoethyl ethylphosphonothiolate

Hex-2-yl S-2-dipropylaminoethyl ethylphosphonothiolate

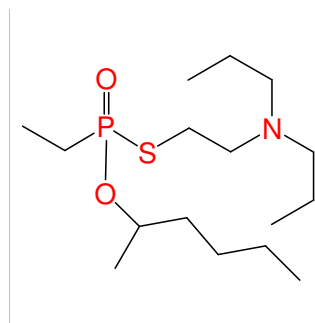

**Chemical name:** 1-Methylpentyl S-2-diethylaminoethyl methylphosphonothiolate

Schedule: 1A03

CAS RN: 1281955-46-1

HS code: 2930.90

Key: 1281955-46-1

Molecular formula: C<sub>13</sub>H<sub>30</sub>NO<sub>2</sub>PS

CAS Index Name: Phosphonothioic acid, methyl-, S-[2-(diethylamino)ethyl] O-(1-methylpentyl) ester

**IUPAC name:** 1-Methylpentyl S-2-diethylaminoethyl methylphosphonothioate

Synonyms: Phosphonothioic acid, methyl-, S-[2-(diethylamino)ethyl] O-hex-2-yl ester

O-1-Methylpentyl S-2-diethylaminoethyl methylphosphonothiolate

Hexan-2-yl S-2-diethylaminoethyl methylphosphonothiolate

Hex-2-yl S-2-diethylaminoethyl methylphosphonothiolate

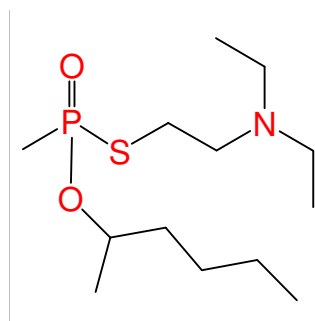

**Chemical name:** Ethyl S-2-diethylpropylammoniummethyl ethylphosphonothiolate iodide

Schedule: 1A03

CAS RN: 1281955-48-3

HS code: 2930.90

Key: 1281955-48-3

Molecular formula: C<sub>13</sub>H<sub>31</sub>INO<sub>2</sub>PS

CAS Index Name: 1-Propanaminium, N-[2-[(ethoxyethylphosphinyl)thio]ethyl]-N,N-diethyl-, iodide

**IUPAC name:** N-(2-[[Ethoxy(ethyl)phosphoryl]thio]ethyl)-N,N-diethylpropan-1-aminium iodide

Synonyms: O-Ethyl S-2-diethylpropylammoniummethyl ethylphosphonothiolate iodide

O-Ethyl S-2-(diethylpropylammonium)ethyl ethylphosphonothiolate iodide

N-(2-[[Ethoxy(ethyl)phosphoryl]sulfanyl]ethyl)-N,N-diethylpropan-1-aminium iodide

Ethanaminium, N,N-diethyl-N-propyl-2-[(ethoxyethylphosphinyl)thio]-, iodide

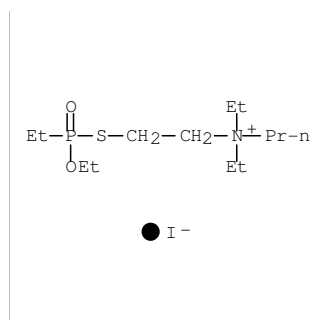

**Chemical name:** Ethyl S-2-dimethylethylammoniummethyl ethylphosphonothiolate iodide

Schedule: 1A03

CAS RN: 1281955-49-4

HS code: 2930.90

Key: 1281955-49-4

Molecular formula: C<sub>10</sub>H<sub>25</sub>INO<sub>2</sub>PS

CAS Index Name: Ethanaminium, 2-[(ethoxyethylphosphinyl)thio]-N-ethyl-N,N-dimethyl-, iodide

**IUPAC name:** 2-[[Ethoxy(ethyl)phosphoryl]thio]-N-ethyl-N,N-dimethylethanaminium iodide

Synonyms: O-Ethyl S-2-dimethylethylammoniummethyl ethylphosphonothiolate iodide

O-Ethyl S-2-(dimethylethylammonium)ethyl ethylphosphonothiolate iodide

Ethanaminium, N,N-dimethyl-N-ethyl-2-[(ethoxyethylphosphinyl)thio]-, iodide

2-[[Ethoxy(ethyl)phosphoryl]sulfanyl]-N-ethyl-N,N-dimethylethanaminium iodide

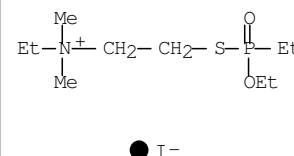

**Chemical name:** Ethyl S-2-diethylmethylammoniummethyl ethylphosphonothiolate iodide

Schedule: 1A03

CAS RN: 1281955-51-8

HS code: 2930.90

Key: 1281955-51-8

Molecular formula: C<sub>11</sub>H<sub>27</sub>INO<sub>2</sub>PS

CAS Index Name: Ethanaminium, 2-[[ethoxy(ethyl)phosphinyl]thio]-N,N-diethyl-N-methyl-, iodide

**IUPAC name:** 2-[[Ethoxy(ethyl)phosphoryl]thio]-N,N-diethyl-N-methylethanaminium iodide

Synonyms: O-Ethyl S-2-diethylmethylammoniummethyl ethylphosphonothiolate iodide

O-Ethyl S-2-(diethylmethylammonium)ethyl ethylphosphonothiolate iodide

Ethanaminium, N,N-diethyl-N-methyl-2-[(ethoxyethylphosphinyl)thio]-, iodide

2-[[Ethoxy(ethyl)phosphoryl]sulfanyl]-N,N-diethyl-N-methylethanaminium iodide

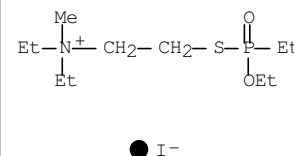

**Chemical name:** Ethyl S-2-dimethylpropylammoniummethyl ethylphosphonothiolate iodide

Schedule: 1A03

CAS RN: 1281955-53-0

HS code: 2930.90

Key: 1281955-53-0

Molecular formula: C<sub>11</sub>H<sub>27</sub>INO<sub>2</sub>PS

CAS Index Name: 1-Propanaminium, N-(2-[[ethoxy(ethyl)phosphinyl]thio]ethyl)-N,N-dimethyl-, iodide

**IUPAC name:** N-(2-[[Ethoxy(ethyl)phosphoryl]thio]ethyl)-N,N-dimethylpropan-1-aminium iodide

Synonyms: O-Ethyl S-2-dimethylpropylammoniummethyl ethylphosphonothiolate iodide

O-Ethyl S-2-(dimethylpropylammonium)ethyl ethylphosphonothiolate iodide

N-(2-[[Ethoxy(ethyl)phosphoryl]sulfanyl]ethyl)-N,N-dimethylpropan-1-aminium iodide

Ethanaminium, N,N-dimethyl-N-propyl-2-[(ethoxyethylphosphinyl)thio]-, iodide

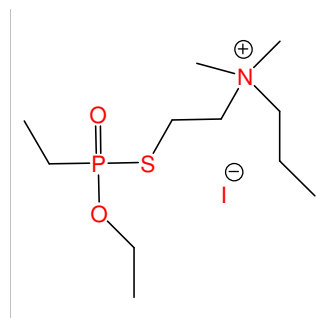

**Chemical name:** Ethyl S-2-diisopropylaminoethyl  
isopropylphosphonothiolate

Schedule: 1A03

CAS RN: 1281955-55-2

HS code: 2930.90

Key: 1281955-55-2

Molecular formula: C<sub>13</sub>H<sub>30</sub>NO<sub>2</sub>PS

CAS Index Name: Phosphonothioic acid, 1-methylethyl-, S-[2-(bis(1-methylethyl)amino)ethyl] O-ethyl ester

**IUPAC name:** Ethyl S-2-diisopropylaminoethyl  
isopropylphosphonothioate

Synonyms: O-Ethyl S-2-diisopropylaminoethyl isopropylphosphonothiolate

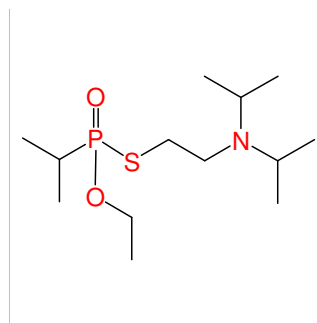

**Chemical name:** Ethyl S-2-trimethylammoniummethyl  
isopropylphosphonothiolate iodide

Schedule: 1A03

CAS RN: 1281955-56-3

HS code: 2930.90

Key: 1281955-56-3

Molecular formula: C<sub>10</sub>H<sub>25</sub>INO<sub>2</sub>PS

CAS Index Name: Ethanaminium, 2-[[ethoxy(1-methylethyl)phosphinyl]thio]-N,N,N-trimethyl-, iodide

**IUPAC name:** 2-[[Ethoxy(isopropyl)phosphoryl]thio]-N,N,N-trimethylethanaminium iodide

Synonyms: O-Ethyl S-2-trimethylammoniummethyl isopropylphosphonothiolate iodide

O-Ethyl S-2 (trimethylammonium)ethyl isopropylphosphonothiolate iodide

Ethanaminium, N,N,N-trimethyl-2-[(ethoxyisopropylphosphinyl)thio]-, iodide

2-[[Ethoxy(isopropyl)phosphoryl]sulfanyl]-N,N,N-trimethylethanaminium iodide

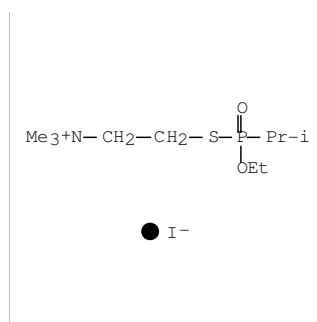

**Chemical name:** Ethyl S-2-triethylammoniummethyl  
methylphosphonothiolate iodide

Schedule: 1A03

CAS RN: 1281955-58-5

HS code: 2930.90

Key: 1281955-58-5

Molecular formula: C<sub>11</sub>H<sub>27</sub>INO<sub>2</sub>PS

CAS Index Name: Ethanaminium, 2-[(ethoxymethylphosphinyl)thio]-N,N,N-triethyl-, iodide

**IUPAC name:** 2-[[Ethoxy(methyl)phosphoryl]thio]-N,N,N-triethylethanaminium iodide

Synonyms: O-Ethyl S-2-triethylammoniummethyl methylphosphonothiolate iodide

O-Ethyl S-2-(triethylammonium)ethyl methylphosphonothiolate iodide

Ethanaminium, N,N,N-triethyl-2-[(ethoxymethylphosphinyl)thio]-, iodide

2-[[Ethoxy(methyl)phosphoryl]sulfanyl]-N,N,N-triethylethanaminium iodide

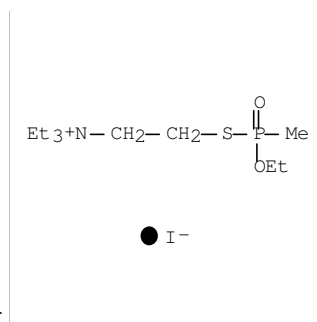



**Chemical name:** Ethyl S-2-dimethylethylammoniummethyl methylphosphonothiolate iodide

Schedule: 1A03

CAS RN: 1281955-59-6

HS code: 2930.90

Key: 1281955-59-6

Molecular formula: C<sub>9</sub>H<sub>23</sub>INO<sub>2</sub>PS

CAS Index Name: Ethanaminium, 2-[(ethoxy)methylphosphinyl]thio}-N-ethyl-N,N-dimethyl-, iodide

**IUPAC name:** 2-{[Ethoxy(methyl)phosphoryl]thio}-N-ethyl-N,N-dimethylethanaminium iodide

Synonyms: O-Ethyl S-2-dimethylethylammoniummethyl methylphosphonothiolate iodide

O-Ethyl S-2-(dimethylethylammonium)ethyl methylphosphonothiolate iodide

Ethanaminium, N-ethyl-N,N-dimethyl-2-[(ethoxymethylphosphinyl)thio]-, iodide

2-{[Ethoxy(methyl)phosphoryl]sulfanyl}-N-ethyl-N,N-dimethylethanaminium iodide

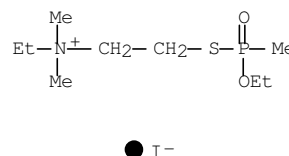

**Chemical name:** Ethyl S-2-dimethylpropylammoniummethyl methylphosphonothiolate iodide

Schedule: 1A03

CAS RN: 1281955-64-3

HS code: 2930.90

Key: 1281955-64-3

Molecular formula: C<sub>10</sub>H<sub>25</sub>INO<sub>2</sub>PS

CAS Index Name: 1-Propanaminium, N-(2-[[ethoxy(methyl)phosphinyl]thio]ethyl)-N,N-dimethyl-, iodide

**IUPAC name:** N-(2-{[Ethoxy(methyl)phosphoryl]thio}ethyl)-N,N-dimethylpropan-1-aminium iodide

Synonyms: O-Ethyl S-2-dimethylpropylammoniummethyl methylphosphonothiolate iodide

O-Ethyl S-2-(dimethylpropylammonium)ethyl methylphosphonothiolate iodide

O-Ethyl S-2-(dimethylpropyl)ammoniummethyl methylphosphonothiolate iodide

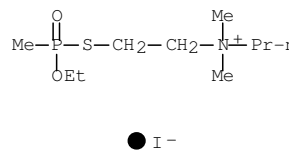

**Chemical name:** Ethyl S-2-dipropylaminoethyl propylphosphonothiolate

Schedule: 1A03

CAS RN: 1281955-65-4

HS code: 2930.90

Key: 1281955-65-4

Molecular formula: C<sub>13</sub>H<sub>30</sub>NO<sub>2</sub>PS

CAS Index Name: Phosphonothioic acid, P-propyl-, S-[2-(dipropylamino)ethyl] O-ethyl ester

**IUPAC name:** Ethyl S-2-dipropylaminoethyl propylphosphonothioate

Synonyms: O-Ethyl S-2-dipropylaminoethyl propylphosphonothiolate

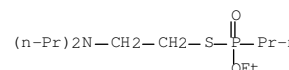

**Chemical name:** Methyl S-2-diethylmethylammoniummethyl ethylphosphonothiolate iodide

Schedule: 1A03

CAS RN: 1281955-67-6

HS code: 2930.90

Key: 1281955-67-6

Molecular formula: C<sub>10</sub>H<sub>25</sub>INO<sub>2</sub>PS

CAS Index Name: Ethanaminium, N,N-diethyl-2-[(ethylmethoxyphosphinyl)thio]-N-methyl-, iodide

**IUPAC name:** N,N-Diethyl-2-{[ethyl(methoxy)phosphoryl]thio}-N-methylethanaminium iodide

Synonyms: O-Methyl S-2-diethylmethylammoniummethyl ethylphosphonothiolate iodide

O-Methyl S-2-(diethylmethylammonium)ethyl ethylphosphonothiolate iodide

N,N-Diethyl-2-{[ethyl(methoxy)phosphoryl]sulfanyl}-N-methylethanaminium iodide

Ethanaminium, N,N-diethyl-N-methyl-2-[(methoxyethylphosphinyl)thio]-, iodide

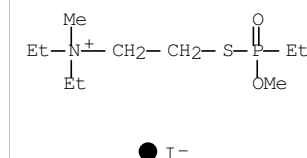

**Chemical name:** Methyl S-2-trimethylammoniummethyl methylphosphonothiolate iodide

Schedule: 1A03

CAS RN: 1281955-68-7

HS code: 2930.90

Key: 1281955-68-7

Molecular formula: C<sub>7</sub>H<sub>19</sub>INO<sub>2</sub>PS

CAS Index Name: Ethanaminium, 2-[(methoxymethylphosphinyl)thio]-N,N,N-trimethyl-, iodide

**IUPAC name:** 2-{[Methoxy(methyl)phosphoryl]thio}-N,N,N-trimethylethanaminium iodide

Synonyms: O-Methyl S-2-trimethylammoniummethyl methylphosphonothiolate iodide

O-Methyl S-2-(trimethylammonium)ethyl methylphosphonothiolate iodide

2-{[Methoxy(methyl)phosphoryl]sulfanyl}-N,N,N-trimethylethanaminium iodide

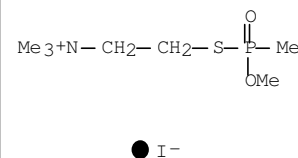

**Chemical name:** Methyl S-2-diisopropylaminoethyl propylphosphonothiolate

Schedule: 1A03

CAS RN: 1281955-69-8

HS code: 2930.90

Key: 1281955-69-8

Molecular formula: C<sub>12</sub>H<sub>28</sub>NO<sub>2</sub>PS

CAS Index Name: Phosphonothioic acid, propyl-, S-[2-(bis(1-methylethyl)amino)ethyl] O-methyl ester

**IUPAC name:** Methyl S-2-diisopropylaminoethyl propylphosphonothioate

Synonyms: O-Methyl S-2-diisopropylaminoethyl propylphosphonothiolate

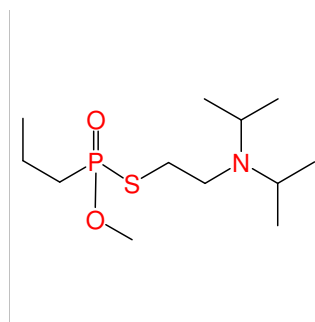

**Chemical name:** Isopropyl S-2-triethylammoniumethyl ethylphosphonothiolate iodide

Schedule: 1A03

CAS RN: 1281955-70-1

HS code: 2930.90

Key: 1281955-70-1

Molecular formula: C<sub>13</sub>H<sub>31</sub>INO<sub>2</sub>PS

CAS Index Name: Ethanaminium, N,N,N-triethyl-2-[[ethyl(1-methylethoxy)phosphinyl]thio]-, iodide

**IUPAC name:** N,N,N-Triethyl-2-[[ethyl(isopropoxy)phosphoryl]thio]ethanaminium iodide

Synonyms: O-Isopropyl S-2-triethylammoniumethyl ethylphosphonothiolate iodide

O-Isopropyl S-2 (triethylammonium)ethyl ethylphosphonothiolate iodide

Ethanaminium, N,N,N-triethyl-2-[(ethylisopropoxyphosphinyl)thio]-, iodide

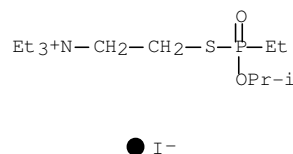

**Chemical name:** Isopropyl S-2-diethylmethylammoniumethyl ethylphosphonothiolate iodide

Schedule: 1A03

CAS RN: 1281955-71-2

HS code: 2930.90

Key: 1281955-71-2

Molecular formula: C<sub>12</sub>H<sub>29</sub>INO<sub>2</sub>PS

CAS Index Name: Ethanaminium, N,N-diethyl-2-[[ethyl(1-methylethoxy)phosphinyl]thio]-N-methyl-, iodide

**IUPAC name:** N,N-Diethyl-2-[[ethyl(isopropoxy)phosphoryl]thio]-N-methylethanaminium iodide

Synonyms: O-Isopropyl S-2-diethylmethylammoniumethyl ethylphosphonothiolate iodide

O-Isopropyl S-2-(diethylmethylammonium)ethyl ethylphosphonothiolate iodide

O-Isopropyl S-2-(diethylmethyl)ammoniumethyl ethylphosphonothiolate iodide

Ethanaminium, N,N-diethyl-N-methyl-2-[(ethylisopropoxyphosphinyl)thio]-, iodide

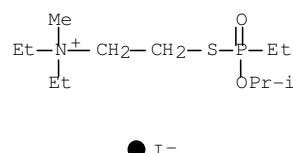

**Chemical name:** Isopropyl S-2-dimethylethylammoniumethyl ethylphosphonothiolate iodide

Schedule: 1A03

CAS RN: 1281955-72-3

HS code: 2930.90

Key: 1281955-72-3

Molecular formula: C<sub>11</sub>H<sub>27</sub>INO<sub>2</sub>PS

CAS Index Name: Ethanaminium, N-ethyl-2-[[ethyl(1-methylethoxy)phosphinyl]thio]-N,N-dimethyl-, iodide

**IUPAC name:** N-Ethyl-2-[[ethyl(isopropoxy)phosphoryl]thio]-N,N-dimethylethanaminium iodide

Synonyms: O-Isopropyl S-2-dimethylethylammoniumethyl ethylphosphonothiolate iodide

O-Isopropyl S-2-(dimethylethylammonium)ethyl ethylphosphonothiolate iodide

Ethanaminium, N-ethyl-N,N-dimethyl-2-[(ethylisopropoxyphosphinyl)thio]-, iodide

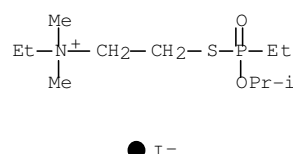

**Chemical name:** Isopropyl S-2-dipropylaminoethyl ethylphosphonothiolate

Schedule: 1A03

CAS RN: 1281955-78-9

HS code: 2930.90

Key: 1281955-78-9

Molecular formula: C<sub>13</sub>H<sub>30</sub>NO<sub>2</sub>PS

CAS Index Name: Phosphonothioic acid, ethyl-, S-[2-(dipropylamino)ethyl] O-(1-methylethyl) ester

**IUPAC name:** Isopropyl S-2-dipropylaminoethyl ethylphosphonothioate

Synonyms: Phosphonothioic acid, ethyl-, S-[2-(dipropylamino)ethyl] O-1-methylethyl ester

O-Isopropyl S-2-dipropylaminoethyl ethylphosphonothiolate

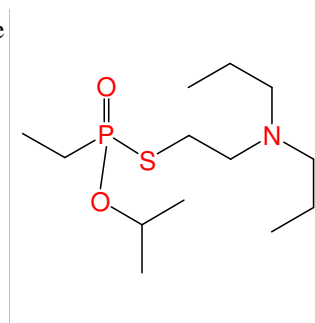

**Chemical name:** Isopropyl S-2-dipropylaminoethyl methylphosphonothiolate

Schedule: 1A03

CAS RN: 1281955-79-0

HS code: 2930.90

Key: 1281955-79-0

Molecular formula: C<sub>12</sub>H<sub>28</sub>NO<sub>2</sub>PS

CAS Index Name: Phosphonothioic acid, methyl-, S-[2-(dipropylamino)ethyl] O-(1-methylethyl) ester

**IUPAC name:** Isopropyl S-2-dipropylaminoethyl methylphosphonothioate

Synonyms: Phosphonothioic acid, methyl-, S-[2-(dipropylamino)ethyl] O-1-methylethyl ester

O-Isopropyl S-2-dipropylaminoethyl methylphosphonothiolate

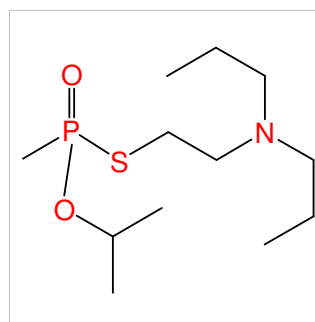

**Chemical name:** Propyl S-2-dipropylaminoethyl ethylphosphonothiolate

Schedule: 1A03

CAS RN: 1281955-80-3

HS code: 2930.90

Key: 1281955-80-3

Molecular formula: C<sub>13</sub>H<sub>30</sub>NO<sub>2</sub>PS

CAS Index Name: Phosphonothioic acid, ethyl-, S-[2-(dipropylamino)ethyl] O-propyl ester

**IUPAC name:** Propyl S-2-dipropylaminoethyl ethylphosphonothioate

Synonyms: O-Propyl S-2-dipropylaminoethyl ethylphosphonothiolate

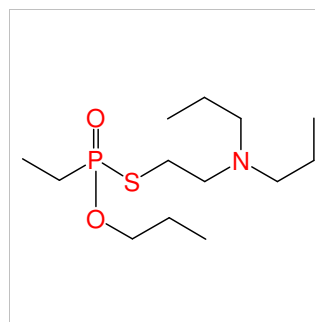

**Chemical name:** Propyl S-2-dimethylaminoethyl isopropylphosphonothiolate

Schedule: 1A03

CAS RN: 1281955-81-4

HS code: 2930.90

Key: 1281955-81-4

Molecular formula: C<sub>10</sub>H<sub>24</sub>NO<sub>2</sub>PS

CAS Index Name: Phosphonothioic acid, 1-methylethyl-, S-[2-(dimethylamino)ethyl] O-propyl ester

**IUPAC name:** Propyl S-2-dimethylaminoethyl isopropylphosphonothioate

Synonyms: O-Propyl S-2-dimethylaminoethyl isopropylphosphonothiolate

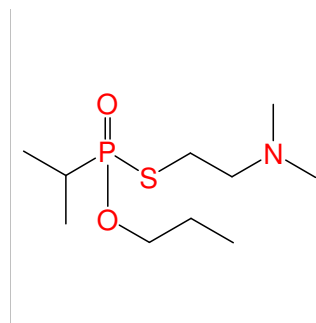

**Chemical name:** Propyl S-2-trimethylammoniummethyl methylphosphonothiolate iodide

Schedule: 1A03

CAS RN: 1281955-82-5

HS code: 2930.90

Key: 1281955-82-5

Molecular formula: C<sub>9</sub>H<sub>23</sub>INO<sub>2</sub>PS

CAS Index Name: Ethanaminium, 2-[[methyl(propoxy)phosphinyl]thio]-N,N,N-trimethyl-, iodide

**IUPAC name:** N,N,N-Trimethyl-2-[[methyl(propoxy)phosphoryl]thio]ethanaminium iodide

Synonyms: O-Propyl S-2-trimethylammoniummethyl methylphosphonothiolate iodide

O-Propyl S-2-(trimethylammonium)ethyl methylphosphonothiolate iodide

Ethanaminium, N,N,N-trimethyl-2-[(methylpropoxyphosphinyl)thio]-, iodide

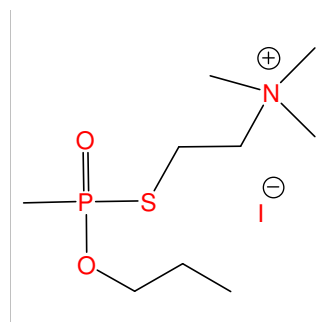

**Chemical name:** Butyl S-2-dimethylaminoethyl ethylphosphonothiolate

Schedule: 1A03

CAS RN: 1281955-85-8

HS code: 2930.90

Key: 1281955-85-8

Molecular formula: C<sub>10</sub>H<sub>24</sub>NO<sub>2</sub>PS

CAS Index Name: Phosphonothioic acid, ethyl-, S-[2-(dimethylamino)ethyl] O-butyl ester

**IUPAC name:** Butyl S-2-dimethylaminoethyl ethylphosphonothioate

Synonyms: O-Butyl S-2-dimethylaminoethyl ethylphosphonothiolate

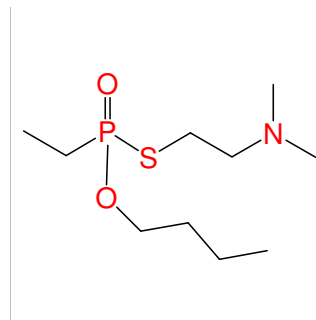

**Chemical name:** Butyl S-2-dipropylaminoethyl ethylphosphonothiolate

Schedule: 1A03

CAS RN: 1281955-86-9

HS code: 2930.90

Key: 1281955-86-9

Molecular formula: C<sub>14</sub>H<sub>32</sub>NO<sub>2</sub>PS

CAS Index Name: Phosphonothioic acid, ethyl-, S-[2-(dipropylamino)ethyl] O-butyl ester

**IUPAC name:** Butyl S-2-dipropylaminoethyl ethylphosphonothioate

Synonyms: O-Butyl S-2-dipropylaminoethyl ethylphosphonothiolate

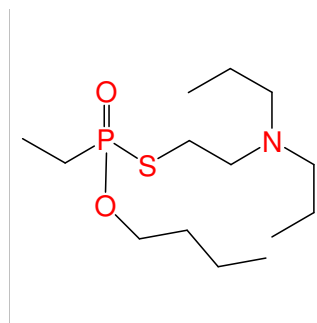

**Chemical name:** 2-Methylpentyl S-2-diisopropylaminoethyl ethylphosphonothiolate

Schedule: 1A03

CAS RN: 1281956-02-2

HS code: 2930.90

Key: 1281956-02-2

Molecular formula: C<sub>16</sub>H<sub>36</sub>NO<sub>2</sub>PS

CAS Index Name: Phosphonothioic acid, ethyl-, S-[2-(bis(1-methylethyl)amino)ethyl] O-(2-methylpentyl) ester

**IUPAC name:** 2-Methylpentyl S-2-diisopropylaminoethyl ethylphosphonothioate

Synonyms: O-2-Methylpentyl S-2-diisopropylaminoethyl ethylphosphonothiolate

2-Methylpentyl S-[2-[bis-(1-methylethyl)amino]ethyl] ethylphosphonothiolate

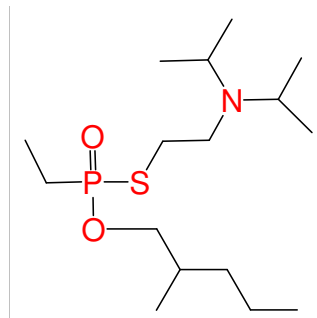

**Chemical name:** S-2-Dimethylaminoethyl isopropylphosphonothiolate

Schedule: 1A03

CAS RN: 1282026-46-3

HS code: 2930.90

Key: 1282026-46-3

Molecular formula: C<sub>7</sub>H<sub>18</sub>NO<sub>2</sub>PS

CAS Index Name: Phosphonothioic acid, 1-methylethyl-, S-[2-(dimethylamino)ethyl] ester

**IUPAC name:** S-2-Dimethylaminoethyl isopropylphosphonothioate

Synonyms: O-Hydrogen S-2-dimethylaminoethyl isopropylphosphonothiolate

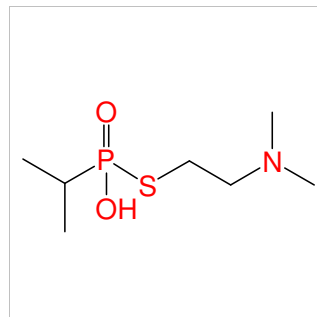

**Chemical name:** S-2-Diethylaminoethyl propylphosphonothiolate

Schedule: 1A03

CAS RN: 1282026-49-6

HS code: 2930.90

Key: 1282026-49-6

Molecular formula: C<sub>9</sub>H<sub>22</sub>NO<sub>2</sub>PS

CAS Index Name: Phosphonothioic acid, propyl-, S-[2-(diethylamino)ethyl] ester

**IUPAC name:** S-2-Diethylaminoethyl propylphosphonothioate

Synonyms: O-Hydrogen S-2-diethylaminoethyl propylphosphonothiolate

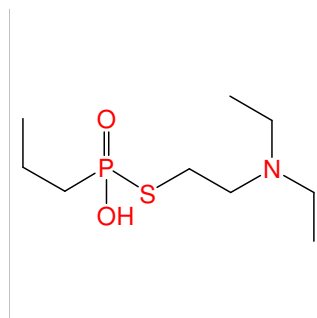

**Chemical name:** S-2-Diisopropylaminoethyl propylphosphonothiolate

Schedule: 1A03

CAS RN: 1282026-50-9

HS code: 2930.90

Key: 1282026-50-9

Molecular formula: C<sub>11</sub>H<sub>26</sub>NO<sub>2</sub>PS

CAS Index Name: Phosphonothioic acid, propyl-, S-[2-(bis(1-methylethyl)amino)ethyl] ester

**IUPAC name:** S-2-Diisopropylaminoethyl propylphosphonothioate

Synonyms: O-Hydrogen S-2-diisopropylaminoethyl propylphosphonothiolate

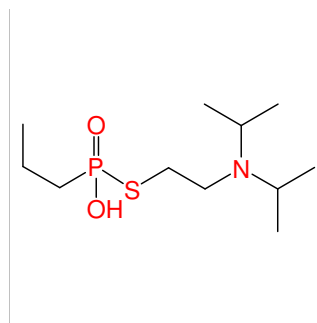

**Chemical name:** 2,2-Dimethylpropyl S-2-dipropylaminoethyl ethylphosphonothiolate

Schedule: 1A03

CAS RN: 1282026-60-1

HS code: 2930.90

Key: 1282026-60-1

Molecular formula: C<sub>15</sub>H<sub>34</sub>NO<sub>2</sub>PS

CAS Index Name: Phosphonothioic acid, ethyl-, S-[2-(dipropylamino)ethyl] O-(2,2-dimethylpropyl) ester

**IUPAC name:** 2,2-Dimethylpropyl S-2-dipropylaminoethyl ethylphosphonothioate

Synonyms: O-2,2-Dimethylpropyl S-2-dipropylaminoethyl ethylphosphonothiolate  
Neopentyl S-2-dipropylaminoethyl ethylphosphonothiolate

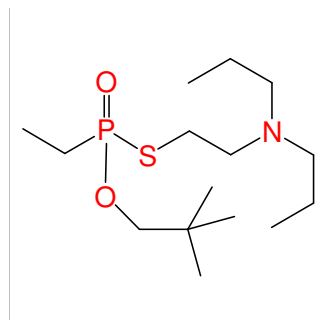

**Chemical name:** 2,2-Dimethylpropyl S-2-diethylaminoethyl methylphosphonothiolate

Schedule: 1A03

CAS RN: 1282026-61-2

HS code: 2930.90

Key: 1282026-61-2

Molecular formula: C<sub>12</sub>H<sub>28</sub>NO<sub>2</sub>PS

CAS Index Name: Phosphonothioic acid, methyl-, S-[2-(diethylamino)ethyl] O-(2,2-dimethylpropyl) ester

**IUPAC name:** 2,2-Dimethylpropyl S-2-diethylaminoethyl methylphosphonothioate

Synonyms: O-2,2-Dimethylpropyl S-2-diethylaminoethyl methylphosphonothiolate  
Neopentyl S-2-diethylaminoethyl methylphosphonothiolate

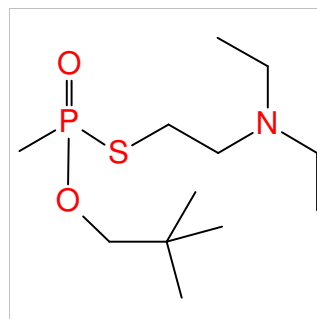

**Chemical name:** 2,2-Dimethylpropyl S-2-diisopropylaminoethyl methylphosphonothiolate

Schedule: 1A03

CAS RN: 1282026-63-4

HS code: 2930.90

Key: 1282026-63-4

Molecular formula: C<sub>14</sub>H<sub>32</sub>NO<sub>2</sub>PS

CAS Index Name: Phosphonothioic acid, methyl-, S-[2-(bis(1-methylethyl)amino)ethyl] O-(2,2-dimethylpropyl) ester

**IUPAC name:** 2,2-Dimethylpropyl S-2-diisopropylaminoethyl methylphosphonothioate

Synonyms: O-2,2-Dimethylpropyl S-2-diisopropylaminoethyl methylphosphonothiolate  
Neopentyl S-2-diisopropylaminoethyl methylphosphonothiolate

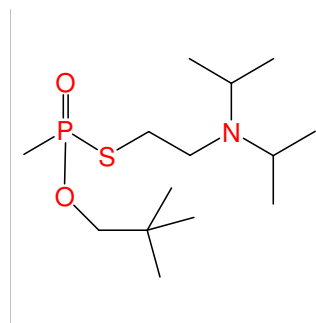

**Chemical name:** Isobutyl S-2-diisopropylaminoethyl ethylphosphonothiolate

Schedule: 1A03

CAS RN: 1282026-64-5

HS code: 2930.90

Key: 1282026-64-5

Molecular formula: C<sub>14</sub>H<sub>32</sub>NO<sub>2</sub>PS

CAS Index Name: Phosphonothioic acid, ethyl-, S-[2-(bis(1-methylethyl)amino)ethyl] O-(2-methylpropyl) ester

**IUPAC name:** Isobutyl S-2-diisopropylaminoethyl ethylphosphonothioate

Synonyms: Phosphonothioic acid, ethyl-, S-[2-(bis(1-methylethyl)amino)ethyl] O-2-methylpropyl ester  
O-Isobutyl S-2-diisopropylaminoethyl ethylphosphonothiolate

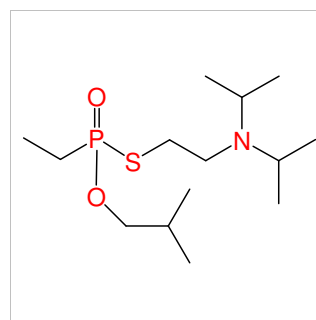

**Chemical name:** Isobutyl S-2-dipropylaminoethyl ethylphosphonothiolate

Schedule: 1A03

CAS RN: 1282026-66-7

HS code: 2930.90

Key: 1282026-66-7

Molecular formula: C<sub>14</sub>H<sub>32</sub>NO<sub>2</sub>PS

CAS Index Name: Phosphonothioic acid, ethyl-, S-[2-(dipropylamino)ethyl] O-(2-methylpropyl) ester

**IUPAC name:** Isobutyl S-2-dipropylaminoethyl ethylphosphonothioate

Synonyms: Phosphonothioic acid, ethyl-, S-[2-(dipropylamino)ethyl] O-2-methylpropyl ester  
O-Isobutyl S-2-dipropylaminoethyl ethylphosphonothiolate

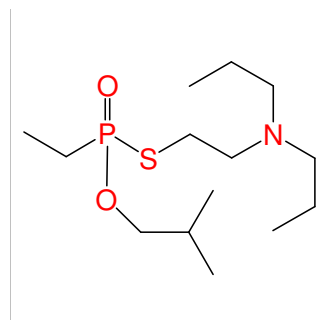



**Chemical name:** sec-Butyl S-2-diisopropylaminoethyl ethylphosphonothiolate

Schedule: 1A03

CAS RN: 1282026-67-8

HS code: 2930.90

Key: 1282026-67-8

Molecular formula: C<sub>14</sub>H<sub>32</sub>NO<sub>2</sub>PS

CAS Index Name: Phosphonothioic acid, ethyl-, S-[2-(bis(1-methylethyl)amino)ethyl] O-(1-methylpropyl) ester

**IUPAC name:** sec-Butyl S-2-diisopropylaminoethyl ethylphosphonothioate

Synonyms: Phosphonothioic acid, ethyl-, S-[2-(bis(1-methylethyl)amino)ethyl] O-1-methylpropyl ester

O-sec-Butyl S-2-diisopropylaminoethyl ethylphosphonothiolate

Butan-2-yl S-2-diisopropylaminoethyl ethylphosphonothiolate

But-2-yl S-2-diisopropylaminoethyl ethylphosphonothiolate

1-Methylpropyl S-2-diisopropylaminoethyl ethylphosphonothiolate

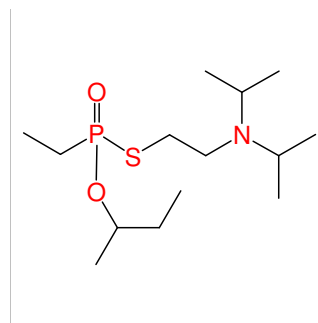

**Chemical name:** sec-Butyl S-2-dipropylaminoethyl ethylphosphonothiolate

Schedule: 1A03

CAS RN: 1282026-70-3

HS code: 2930.90

Key: 1282026-70-3

Molecular formula: C<sub>14</sub>H<sub>32</sub>NO<sub>2</sub>PS

CAS Index Name: Phosphonothioic acid, ethyl-, S-[2-(dipropylamino)ethyl] O-(1-methylpropyl) ester

**IUPAC name:** sec-Butyl S-2-dipropylaminoethyl ethylphosphonothioate

Synonyms: Phosphonothioic acid, ethyl-, S-[2-(dipropylamino)ethyl] O-1-methylpropyl ester

O-sec-Butyl S-2-dipropylaminoethyl ethylphosphonothiolate

Butan-2-yl S-2-dipropylaminoethyl ethylphosphonothiolate

But-2-yl S-2-dipropylaminoethyl ethylphosphonothiolate

1-Methylpropyl S-2-dipropylaminoethyl ethylphosphonothiolate

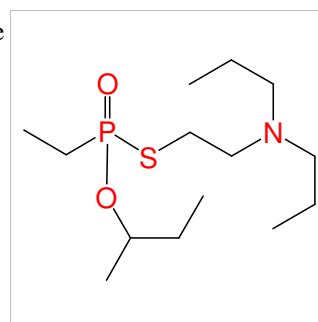

**Chemical name:** sec-Butyl S-2-dimethylaminoethyl methylphosphonothiolate

Schedule: 1A03

CAS RN: 1282026-72-5

HS code: 2930.90

Key: 1282026-72-5

Molecular formula: C<sub>9</sub>H<sub>22</sub>NO<sub>2</sub>PS

CAS Index Name: Phosphonothioic acid, methyl-, S-[2-(dimethylamino)ethyl] O-(1-methylpropyl) ester

**IUPAC name:** sec-Butyl S-2-dimethylaminoethyl methylphosphonothioate

Synonyms: Phosphonothioic acid, methyl-, S-[2-(dimethylamino)ethyl] O-but-2-yl ester

Phosphonothioic acid, methyl-, S-[2-(dimethylamino)ethyl] O-1-methylpropyl ester

O-sec-Butyl S-2-dimethylaminoethyl methylphosphonothiolate

Butan-2-yl S-2-dimethylaminoethyl methylphosphonothiolate

But-2-yl S-2-dimethylaminoethyl methylphosphonothiolate

1-Methylpropyl S-2-dimethylaminoethyl methylphosphonothiolate

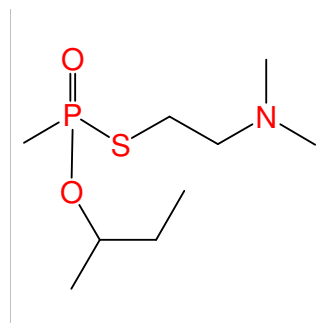

**Chemical name:** Cyclopentyl S-2-dimethylaminoethyl ethylphosphonothiolate

Schedule: 1A03

CAS RN: 1282026-74-7

HS code: 2930.90

Key: 1282026-74-7

Molecular formula: C<sub>11</sub>H<sub>24</sub>NO<sub>2</sub>PS

CAS Index Name: Phosphonothioic acid, ethyl-, S-[2-(dimethylamino)ethyl] O-cyclopentyl ester

**IUPAC name:** Cyclopentyl S-2-dimethylaminoethyl ethylphosphonothioate

Synonyms: O-Cyclopentyl S-2-dimethylaminoethyl ethylphosphonothiolate

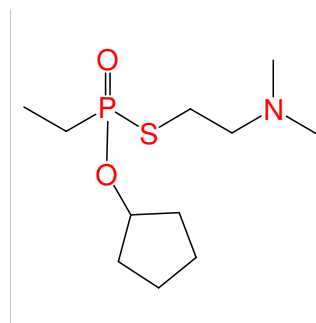

**Chemical name:** Cyclopentyl S-2-dipropylaminoethyl ethylphosphonothiolate

Schedule: 1A03

CAS RN: 1282026-77-0

HS code: 2930.90

Key: 1282026-77-0

Molecular formula: C<sub>15</sub>H<sub>32</sub>NO<sub>2</sub>PS

CAS Index Name: Phosphonothioic acid, ethyl-, S-[2-(dipropylamino)ethyl] O-cyclopentyl ester

**IUPAC name:** Cyclopentyl S-2-dipropylaminoethyl ethylphosphonothioate

Synonyms: O-Cyclopentyl S-2-dipropylaminoethyl ethylphosphonothiolate

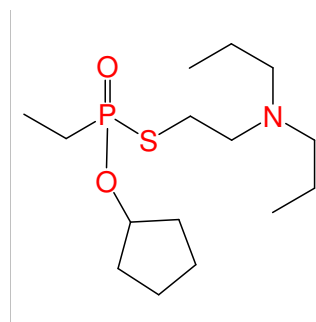

**Chemical name:** Cyclopentyl S-2-dipropylaminoethyl methylphosphonothiolate

Schedule: 1A03

CAS RN: 1282026-78-1

HS code: 2930.90

Key: 1282026-78-1

Molecular formula: C<sub>14</sub>H<sub>30</sub>NO<sub>2</sub>PS

CAS Index Name: Phosphonothioic acid, methyl-, S-[2-(dipropylamino)ethyl] O-cyclopentyl ester

**IUPAC name:** Cyclopentyl S-2-dipropylaminoethyl methylphosphonothioate

Synonyms: O-Cyclopentyl S-2-dipropylaminoethyl methylphosphonothiolate

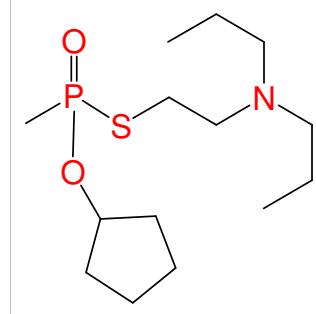

**Chemical name:** Nonyl S-2-diethylaminoethyl methylphosphonothiolate

Schedule: 1A03

CAS RN: 1282026-79-2

HS code: 2930.90

Key: 1282026-79-2

Molecular formula: C<sub>16</sub>H<sub>36</sub>NO<sub>2</sub>PS

CAS Index Name: Phosphonothioic acid, methyl-, S-[2-(diethylamino)ethyl] O-nonyl ester

**IUPAC name:** Nonyl S-2-diethylaminoethyl methylphosphonothioate

Synonyms: O-Nonyl S-2-diethylaminoethyl methylphosphonothiolate

Nonyl S-[2-(diethylamino)ethyl] methylphosphonothiolate

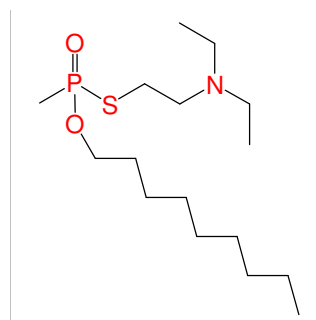

**Chemical name:** Nonyl S-2-diisopropylaminoethyl methylphosphonothiolate

Schedule: 1A03

CAS RN: 1282026-81-6

HS code: 2930.90

Key: 1282026-81-6

Molecular formula: C<sub>18</sub>H<sub>40</sub>NO<sub>2</sub>PS

CAS Index Name: Phosphonothioic acid, methyl-, S-[2-(bis(1-methylethyl)amino)ethyl] O-nonyl ester

**IUPAC name:** Nonyl S-2-diisopropylaminoethyl methylphosphonothioate

Synonyms: O-Nonyl S-2-diisopropylaminoethyl methylphosphonothiolate

Nonyl S-[2-(diisopropylamino)ethyl] methylphosphonothiolate

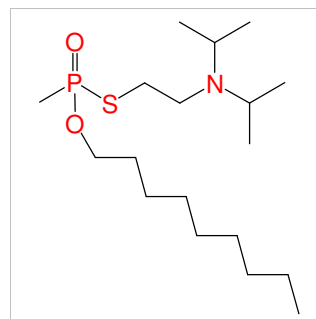

**Chemical name:** Nonyl S-2-dimethylaminoethyl methylphosphonothiolate

Schedule: 1A03

CAS RN: 1282026-82-7

HS code: 2930.90

Key: 1282026-82-7

Molecular formula: C<sub>14</sub>H<sub>32</sub>NO<sub>2</sub>PS

CAS Index Name: Phosphonothioic acid, methyl-, S-[2-(dimethylamino)ethyl] O-nonyl ester

**IUPAC name:** Nonyl S-2-dimethylaminoethyl methylphosphonothioate

Synonyms: O-Nonyl S-2-dimethylaminoethyl methylphosphonothiolate

Nonyl S-[2-(dimethylamino)ethyl] methylphosphonothiolate

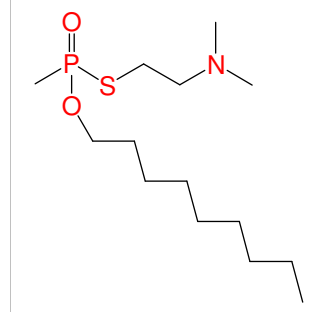

**Chemical name:** 2-Methylcyclopentyl S-2-diethylaminoethyl ethylphosphonothiolate

Schedule: 1A03

CAS RN: 1282026-84-9

HS code: 2930.90

Key: 1282026-84-9

Molecular formula: C<sub>14</sub>H<sub>30</sub>NO<sub>2</sub>PS

CAS Index Name: Phosphonothioic acid, ethyl-, S-[2-(diethylamino)ethyl] O-(2-methylcyclopentyl) ester

**IUPAC name:** 2-Methylcyclopentyl S-2-diethylaminoethyl ethylphosphonothioate

Synonyms: O-2-Methylcyclopentyl S-2-diethylaminoethyl ethylphosphonothiolate

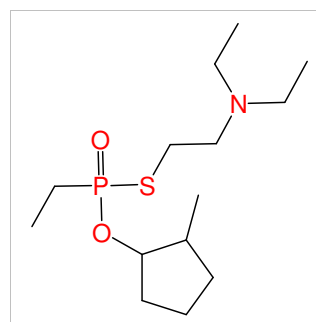

**Chemical name:** 2-Methylcyclopentyl S-2-diisopropylaminoethyl ethylphosphonothiolate

Schedule: 1A03

CAS RN: 1282026-85-0

HS code: 2930.90

Key: 1282026-85-0

Molecular formula: C<sub>16</sub>H<sub>34</sub>NO<sub>2</sub>PS

CAS Index Name: Phosphonothioic acid, ethyl-, S-[2-(bis(1-methylethyl)amino)ethyl] O-(2-methylcyclopentyl) ester

**IUPAC name:** 2-Methylcyclopentyl S-2-diisopropylaminoethyl ethylphosphonothioate

Synonyms: O-2-Methylcyclopentyl S-2-diisopropylaminoethyl ethylphosphonothiolate

2-Methylcyclopentyl S-[2-(diisopropylamino)ethyl] ethylphosphonothiolate

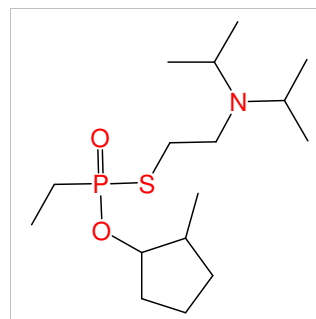

**Chemical name:** 2-Methylcyclopentyl S-2-dipropylaminoethyl ethylphosphonothiolate

Schedule: 1A03

CAS RN: 1282026-88-3

HS code: 2930.90

Key: 1282026-88-3

Molecular formula: C<sub>16</sub>H<sub>34</sub>NO<sub>2</sub>PS

CAS Index Name: Phosphonothioic acid, ethyl-, S-[2-(dipropylamino)ethyl] O-(2-methylcyclopentyl) ester

**IUPAC name:** 2-Methylcyclopentyl S-2-dipropylaminoethyl ethylphosphonothioate

Synonyms: O-2-Methylcyclopentyl S-2-dipropylaminoethyl ethylphosphonothiolate  
2-Methylcyclopentyl S-[2-(dipropylamino)ethyl] ethylphosphonothiolate

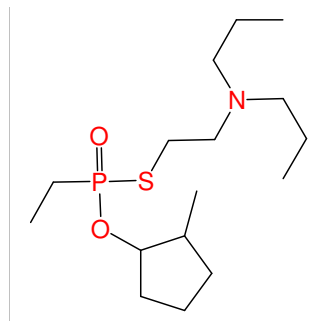

**Chemical name:** 2-Methylcyclopentyl S-2-diethylaminoethyl methylphosphonothiolate

Schedule: 1A03

CAS RN: 1282026-89-4

HS code: 2930.90

Key: 1282026-89-4

Molecular formula: C<sub>13</sub>H<sub>28</sub>NO<sub>2</sub>PS

CAS Index Name: Phosphonothioic acid, methyl-, S-[2-(diethylamino)ethyl] O-(2-methylcyclopentyl) ester

**IUPAC name:** 2-Methylcyclopentyl S-2-diethylaminoethyl methylphosphonothioate

Synonyms: O-2-Methylcyclopentyl S-2-diethylaminoethyl methylphosphonothiolate  
2-Methylcyclopentyl S-[2-(diethylamino)ethyl] methylphosphonothiolate

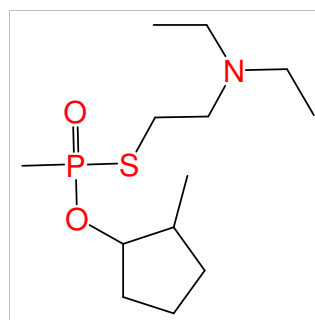

**Chemical name:** 2-Methylcyclopentyl S-2-diisopropylaminoethyl methylphosphonothiolate

Schedule: 1A03

CAS RN: 1282026-90-7

HS code: 2930.90

Key: 1282026-90-7

Molecular formula: C<sub>15</sub>H<sub>32</sub>NO<sub>2</sub>PS

CAS Index Name: Phosphonothioic acid, methyl-, S-[2-(bis(1-methylethyl)amino)ethyl] O-(2-methylcyclopentyl) ester

**IUPAC name:** 2-Methylcyclopentyl S-2-diisopropylaminoethyl methylphosphonothioate

Synonyms: O-2-Methylcyclopentyl S-2-diisopropylaminoethyl methylphosphonothiolate  
2-Methylcyclopentyl S-[2-(diisopropylamino)ethyl] methylphosphonothiolate

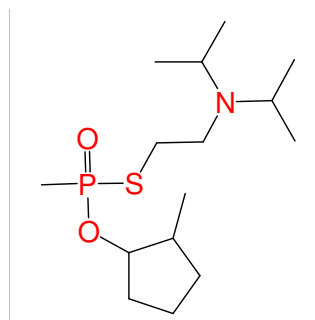

**Chemical name:** 2-Methylcyclopentyl S-2-dipropylaminoethyl methylphosphonothiolate

Schedule: 1A03

CAS RN: 1282026-91-8

HS code: 2930.90

Key: 1282026-91-8

Molecular formula: C<sub>15</sub>H<sub>32</sub>NO<sub>2</sub>PS

CAS Index Name: Phosphonothioic acid, methyl-, S-[2-(dipropylamino)ethyl] O-(2-methylcyclopentyl) ester

**IUPAC name:** 2-Methylcyclopentyl S-2-dipropylaminoethyl methylphosphonothioate

Synonyms: O-2-Methylcyclopentyl S-2-dipropylaminoethyl methylphosphonothiolate  
2-Methylcyclopentyl S-[2-(dipropylamino)ethyl] methylphosphonothiolate

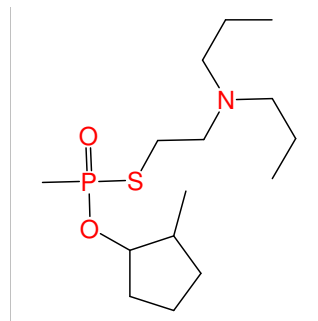

**Chemical name:** 1,2-Dimethylbutyl S-2-diethylaminoethyl ethylphosphonothiolate

Schedule: 1A03

CAS RN: 1282026-95-2

HS code: 2930.90

Key: 1282026-95-2

Molecular formula: C<sub>14</sub>H<sub>32</sub>NO<sub>2</sub>PS

CAS Index Name: Phosphonothioic acid, ethyl-, S-[2-(diethylamino)ethyl] O-(1,2-dimethylbutyl) ester

**IUPAC name:** 1,2-Dimethylbutyl S-2-diethylaminoethyl ethylphosphonothioate

Synonyms: Phosphonothioic acid, ethyl-, S-[2-(diethylamino)ethyl] O-3-methylpent-2-yl ester  
O-3-Methylpent-2-yl S-[2-(diethylamino)ethyl]- ethylphosphonothiolate  
O-1,2-Dimethylbutyl S-2-diethylaminoethyl ethylphosphonothiolate  
3-Methylpentan-2-yl S-2-diethylaminoethyl ethylphosphonothiolate  
3-Methylpent-2-yl S-2-diethylaminoethyl ethylphosphonothiolate

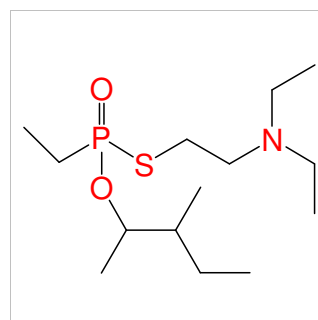

**Chemical name:** 1,2-Dimethylbutyl S-2-diisopropylaminoethyl ethylphosphonothiolate

Schedule: 1A03

CAS RN: 1282026-96-3

HS code: 2930.90

Key: 1282026-96-3

Molecular formula: C<sub>16</sub>H<sub>36</sub>NO<sub>2</sub>PS

CAS Index Name: Phosphonothioic acid, ethyl-, S-[2-(bis(1-methylethyl)amino)ethyl] O-(1,2-dimethylbutyl) ester

**IUPAC name:** 1,2-Dimethylbutyl S-2-diisopropylaminoethyl ethylphosphonothioate

Synonyms: Phosphonothioic acid, ethyl-, S-[2-(bis-(1-methylethyl)amino)ethyl] O-3-methylpent-2-yl ester  
O-1,2-Dimethylbutyl S-2-diisopropylaminoethyl ethylphosphonothiolate  
3-Methylpentan-2-yl S-2-diisopropylaminoethyl ethylphosphonothiolate  
3-Methylpent-2-yl S-2-diisopropylaminoethyl ethylphosphonothiolate

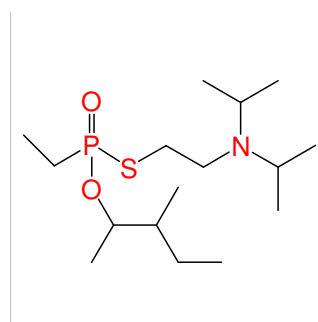

**Chemical name:** 1,2-Dimethylbutyl S-2-dipropylaminoethyl ethylphosphonothiolate

Schedule: 1A03

CAS RN: 1282026-97-4

HS code: 2930.90

Key: 1282026-97-4

Molecular formula: C<sub>16</sub>H<sub>36</sub>NO<sub>2</sub>PS

CAS Index Name: Phosphonothioic acid, ethyl-, S-[2-(dipropylamino)ethyl] O-(1,2-dimethylbutyl) ester

**IUPAC name:** 1,2-Dimethylbutyl S-2-dipropylaminoethyl ethylphosphonothioate

Synonyms: Phosphonothioic acid, ethyl-, S-[2-(dipropylamino)ethyl] O-3-methylpent-2-yl ester  
O-1,2-Dimethylbutyl S-2-dipropylaminoethyl ethylphosphonothiolate  
3-Methylpentan-2-yl S-2-dipropylaminoethyl ethylphosphonothiolate  
3-Methylpent-2-yl S-2-dipropylaminoethyl ethylphosphonothiolate

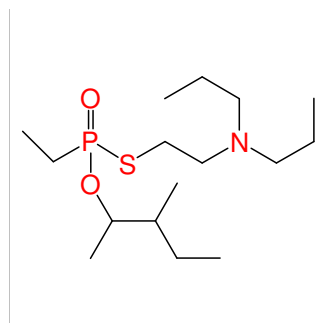

**Chemical name:** 1,2-Dimethylbutyl S-2-diethylaminoethyl methylphosphonothiolate

Schedule: 1A03

CAS RN: 1282026-98-5

HS code: 2930.90

Key: 1282026-98-5

Molecular formula: C<sub>13</sub>H<sub>30</sub>NO<sub>2</sub>PS

CAS Index Name: Phosphonothioic acid, methyl-, S-[2-(diethylamino)ethyl] O-(1,2-dimethylbutyl) ester

**IUPAC name:** 1,2-Dimethylbutyl S-2-diethylaminoethyl methylphosphonothioate

Synonyms: Phosphonothioic acid, methyl-, S-[2-(diethylamino)ethyl] O-3-methylpent-2-yl ester  
O-1,2-Dimethylbutyl S-2-diethylaminoethyl methylphosphonothiolate  
3-Methylpentan-2-yl S-2-diethylaminoethyl methylphosphonothiolate  
3-Methylpent-2-yl S-2-diethylaminoethyl methylphosphonothiolate

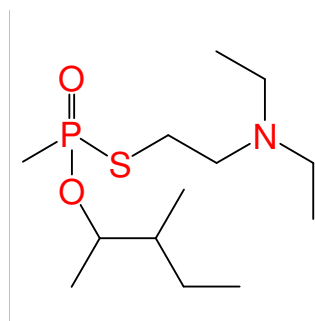

**Chemical name:** 1,2-Dimethylbutyl S-2-diisopropylaminoethyl methylphosphonothiolate

Schedule: 1A03

CAS RN: 1282026-99-6

HS code: 2930.90

Key: 1282026-99-6

Molecular formula: C<sub>15</sub>H<sub>34</sub>NO<sub>2</sub>PS

CAS Index Name: Phosphonothioic acid, methyl-, S-[2-(bis(1-methylethyl)amino)ethyl] O-(1,2-dimethylbutyl) ester

**IUPAC name:** 1,2-Dimethylbutyl S-2-diisopropylaminoethyl methylphosphonothioate

Synonyms: Phosphonothioic acid, methyl-, S-[2-(bis(1-methylethyl)amino)ethyl] O-3-methylpent-2-yl ester  
O-1,2-Dimethylbutyl S-2-diisopropylaminoethyl methylphosphonothiolate  
3-Methylpentan-2-yl S-2-diisopropylaminoethyl methylphosphonothiolate  
3-Methylpent-2-yl S-2-diisopropylaminoethyl methylphosphonothiolate

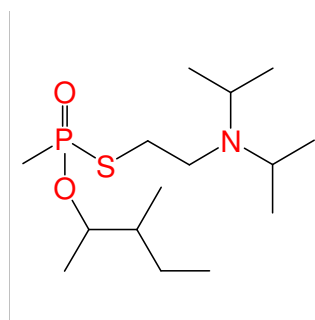

**Chemical name:** 1,2-Dimethylbutyl S-2-dipropylaminoethyl methylphosphonothiolate

Schedule: 1A03

CAS RN: 1282027-00-2

HS code: 2930.90

Key: 1282027-00-2

Molecular formula: C<sub>15</sub>H<sub>34</sub>NO<sub>2</sub>PS

CAS Index Name: Phosphonothioic acid, methyl-, S-[2-(dipropylamino)ethyl] O-(1,2-dimethylbutyl) ester

**IUPAC name:** 1,2-Dimethylbutyl S-2-dipropylaminoethyl methylphosphonothioate

Synonyms: Phosphonothioic acid, methyl-, S-[2-(dipropylamino)ethyl] O-3-methylpent-2-yl ester  
O-1,2-Dimethylbutyl S-2-dipropylaminoethyl methylphosphonothiolate  
3-Methylpentan-2-yl S-2-dipropylaminoethyl methylphosphonothiolate  
3-Methylpent-2-yl S-2-dipropylaminoethyl methylphosphonothiolate

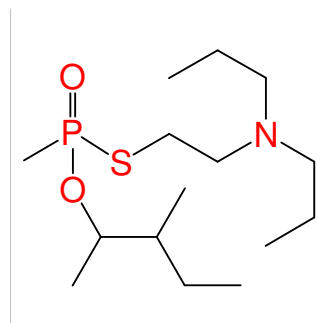

**Chemical name:** 1-Ethylpropyl S-2-diethylaminoethyl ethylphosphonothiolate

Schedule: 1A03

CAS RN: 1282027-02-4

HS code: 2930.90

Key: 1282027-02-4

Molecular formula: C<sub>13</sub>H<sub>30</sub>NO<sub>2</sub>PS

CAS Index Name: Phosphonothioic acid, ethyl-, S-[2-(diethylamino)ethyl] O-(1-ethylpropyl) ester

**IUPAC name:** 1-Ethylpropyl S-2-diethylaminoethyl ethylphosphonothioate

Synonyms: S-[2-(diethylamino)ethyl] O-pent-3-yl ethylphosphonothiolate  
Phosphonothioic acid, ethyl-, S-[2-(diethylamino)ethyl] O-(1-ethylpropyl) ester  
Pentan-3-yl S-2-diethylaminoethyl ethylphosphonothiolate  
Pent-3-yl S-2-diethylaminoethyl ethylphosphonothiolate  
O-1-Ethylpropyl S-2-diethylaminoethyl ethylphosphonothiolate

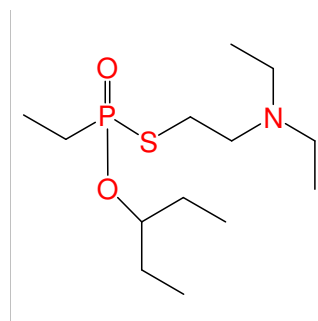



**Chemical name:** 1-Ethylpropyl S-2-diisopropylaminoethyl ethylphosphonothiolate

Schedule: 1A03

CAS RN: 1282027-03-5 HS code: 2930.90

Key: 1282027-03-5

Molecular formula: C<sub>15</sub>H<sub>34</sub>NO<sub>2</sub>PS

CAS Index Name: Phosphonothioic acid, ethyl-, S-[2-(bis(1-methylethyl)amino)ethyl] O-(1-ethylpropyl) ester

**IUPAC name:** 1-Ethylpropyl S-2-diisopropylaminoethyl ethylphosphonothioate

Synonyms: S-[2-(diisopropylamino)ethyl] O-pent-3-yl ethylphosphonothiolate

Phosphonothioic acid, ethyl-, S-[2-(bis(1-methylethyl)amino)ethyl] O-(1-ethylpropyl) e

Pentan-3-yl S-2-diisopropylaminoethyl ethylphosphonothiolate

Pent-3-yl S-2-diisopropylaminoethyl ethylphosphonothiolate

O-1-Ethylpropyl S-2-diisopropylaminoethyl ethylphosphonothiolate

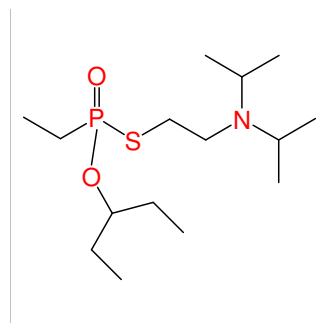

**Chemical name:** 3,3-Dimethylbutyl S-2-dimethylaminoethyl methylphosphonothiolate

Schedule: 1A03

CAS RN: 1282027-05-7 HS code: 2930.90

Key: 1282027-05-7

Molecular formula: C<sub>11</sub>H<sub>26</sub>NO<sub>2</sub>PS

CAS Index Name: Phosphonothioic acid, methyl-, S-[2-(dimethylamino)ethyl] O-(3,3-dimethylbutyl) ester

**IUPAC name:** 3,3-Dimethylbutyl S-2-dimethylaminoethyl methylphosphonothioate

Synonyms: O-3,3-Dimethylbutyl S-2-dimethylaminoethyl methylphosphonothiolate

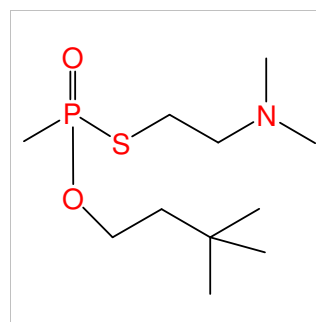

**Chemical name:** 1-Methylpentyl S-2-diethylaminoethyl ethylphosphonothiolate

Schedule: 1A03

CAS RN: 1282027-07-9 HS code: 2930.90

Key: 1282027-07-9

Molecular formula: C<sub>14</sub>H<sub>32</sub>NO<sub>2</sub>PS

CAS Index Name: Phosphonothioic acid, ethyl-, S-[2-(diethylamino)ethyl] O-(1-methylpentyl) ester

**IUPAC name:** 1-Methylpentyl S-2-diethylaminoethyl ethylphosphonothioate

Synonyms: Phosphonothioic acid, ethyl-, S-[2-(diethylamino)ethyl] O-hex-2-yl ester

O-1-Methylpentyl S-2-diethylaminoethyl ethylphosphonothiolate

Hexan-2-yl S-2-diethylaminoethyl ethylphosphonothiolate

Hex-2-yl S-2-diethylaminoethyl ethylphosphonothiolate

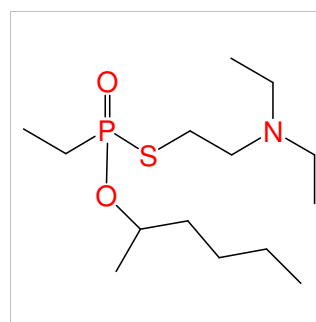

**Chemical name:** S-2-Dipropylaminoethyl ethylphosphonothiolate

Schedule: 1A03

CAS RN: 1282093-77-9

HS code: 2930.90

Key: 1282093-77-9

Molecular formula: C<sub>10</sub>H<sub>24</sub>NO<sub>2</sub>PS

CAS Index Name: Phosphonothioic acid, ethyl-, S-[2-(dipropylamino)ethyl] ester

**IUPAC name:** S-2-Dipropylaminoethyl ethylphosphonothioate

Synonyms: O-Hydrogen S-2-dipropylaminoethyl ethylphosphonothiolate

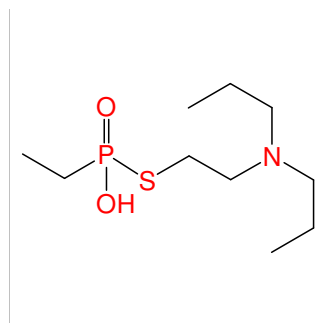

**Chemical name:** S-2-Diethylaminoethyl isopropylphosphonothiolate

Schedule: 1A03

CAS RN: 1282093-78-0

HS code: 2930.90

Key: 1282093-78-0

Molecular formula: C<sub>9</sub>H<sub>22</sub>NO<sub>2</sub>PS

CAS Index Name: Phosphonothioic acid, 1-methylethyl-, S-[2-(diethylamino)ethyl] ester

**IUPAC name:** S-2-Diethylaminoethyl isopropylphosphonothioate

Synonyms: O-Hydrogen S-2-diethylaminoethyl isopropylphosphonothiolate

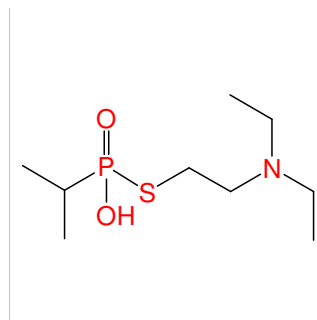

**Chemical name:** S-2-Diisopropylaminoethyl isopropylphosphonothiolate

Schedule: 1A03

CAS RN: 1282093-79-1

HS code: 2930.90

Key: 1282093-79-1

Molecular formula: C<sub>11</sub>H<sub>26</sub>NO<sub>2</sub>PS

CAS Index Name: Phosphonothioic acid, 1-methylethyl-, S-[2-(bis(1-methylethyl)amino)ethyl] ester

**IUPAC name:** S-2-Diisopropylaminoethyl isopropylphosphonothioate

Synonyms: O-Hydrogen S-2-diisopropylaminoethyl isopropylphosphonothiolate

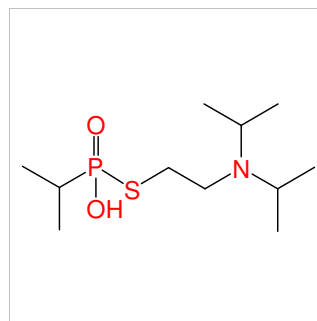

**Chemical name:** Ethyl S-2-diethylmethylammoniummethyl ethylphosphonothiolate

Schedule: 1A03

CAS RN: 1282094-28-3

HS code: 2930.90

Key: 1282094-28-3

Molecular formula: C<sub>11</sub>H<sub>27</sub>NO<sub>2</sub>PS

CAS Index Name: Ethanaminium, 2-[(ethoxyethylphosphinyl)thio]-N,N-diethyl-N-methyl-

**IUPAC name:**

Synonyms:

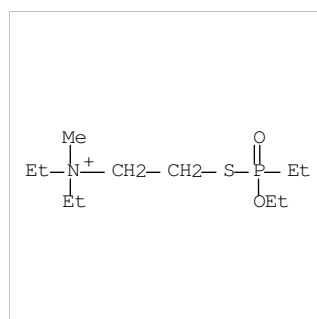

**Chemical name:** Isopropyl S-2-dimethylaminoethyl methylphosphonothiolate hydrochloride (1:X), [P(S)]-

Schedule: 1A03

CAS RN: 1293993-38-0 HS code: 2930.90

Key: 1293993-38-0

Molecular formula: C<sub>8</sub>H<sub>20</sub>NO<sub>2</sub>PS · xClH

CAS Index Name: Phosphonothioic acid, P-methyl-, S-[2-(dimethylamino)ethyl] O-(1-methylethyl) ester, hydrochloride (1:?), [P(S)]-

**IUPAC name:**

Synonyms:

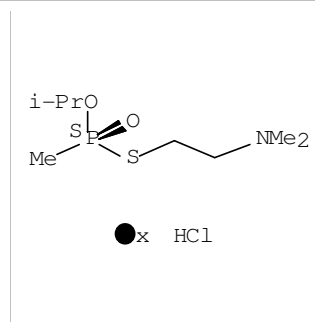

**Chemical name:** Cyclohexyl S-2-diethylmethylammoniumethyl methylphosphonothiolate iodide

Schedule: 1A03

CAS RN: 132412-52-3 HS code: 2930.90

Key: 132412-52-3

Molecular formula: C<sub>14</sub>H<sub>31</sub>INO<sub>2</sub>PS

CAS Index Name: Ethanaminium, 2-[[[(cyclohexyloxy)methylphosphinyl]thio]-N,N-diethyl-N-methyl-, iodide

**IUPAC name:** N,N-Diethyl-2-[[[(cyclohexyloxy)methylphosphoryl]thio]-N-methylethanaminium iodide

Synonyms: O-Cyclohexyl S-2-diethylmethylammoniumethyl methylphosphonothiolate iodide

Ethanaminium, N,N-diethyl-N-methyl-2-[(cyclohexyloxymethylphosphinyl)thio]-, iodide

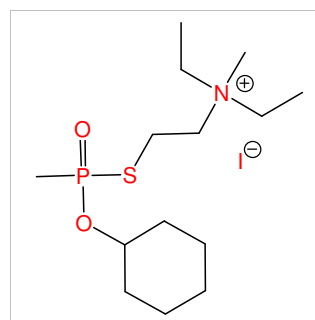

**Chemical name:** Isopropyl S-2-dimethylaminoethyl methylphosphonothiolate hydrochloride (1:1), [P(S)]-

Schedule: 1A03

CAS RN: 1353880-64-4 HS code: 2930.90

Key: 1353880-64-4

Molecular formula: C<sub>8</sub>H<sub>20</sub>NO<sub>2</sub>PS.ClH

CAS Index Name: Phosphonothioic acid, P-methyl-, S-[2-(dimethylamino)ethyl] O-(1-methylethyl) ester, hydrochloride (1:1), [P(S)]-

**IUPAC name:**

Synonyms:

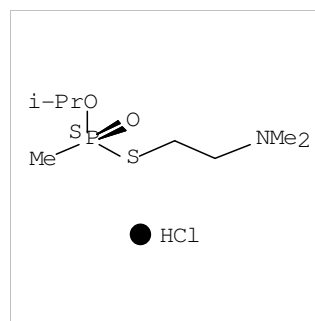

**Chemical name:** Isobutyl S-2-diethylaminoethyl methylphosphonothiolate (H<sup>+</sup>)

Schedule: 1A03

CAS RN: 1369919-44-7

HS code: 2930.90

Key: 1369919-44-7

Molecular formula: C<sub>11</sub>H<sub>26</sub>NO<sub>2</sub>PS.H

CAS Index Name: Phosphonothioic acid, P-methyl-, S-[2-(diethylamino)ethyl] O-(2-methylpropyl) ester, conjugate acid (1:1)

**IUPAC name:**

Synonyms:

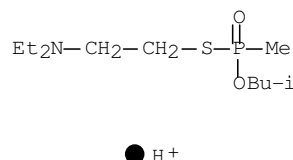

**Chemical name:** (S)-Isopropyl S-2-dimethylaminoethyl methylphosphonothiolate

Schedule: 1A03

CAS RN: 13915-98-5

HS code: 2930.90

Key: 13915-98-5

Molecular formula: C<sub>8</sub>H<sub>20</sub>NO<sub>2</sub>PS

CAS Index Name: Phosphonothioic acid, methyl-, S-[2-(dimethylamino)ethyl] O-(1-methylethyl) ester, (S)-

**IUPAC name:** Isopropyl S-2-dimethylaminoethyl (S)-methylphosphonothioate

Synonyms: O-Propan-2-yl S-[2-(dimethylamino)ethyl] (S)-methylphosphonothioate

(S)-O-Isopropyl S-2-dimethylaminoethyl methylphosphonothiolate

(+)-Phosphonothioic acid, methyl-, S-[2-(dimethylamino)ethyl] O-isopropyl ester

(+)-O-Isopropyl S-2-dimethylaminoethyl methylphosphonothiolate

(+)-Isopropyl S-2-dimethylaminoethyl methylphosphonothiolate

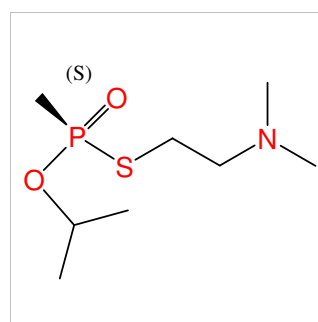

**Chemical name:** (R)-Isopropyl S-2-dimethylaminoethyl methylphosphonothiolate

Schedule: 1A03

CAS RN: 13915-99-6

HS code: 2930.90

Key: 13915-99-6

Molecular formula: C<sub>8</sub>H<sub>20</sub>NO<sub>2</sub>PS

CAS Index Name: Phosphonothioic acid, methyl-, S-[2-(dimethylamino)ethyl] O-(1-methylethyl) ester, (R)-

**IUPAC name:** Isopropyl S-2-dimethylaminoethyl (R)-methylphosphonothioate

Synonyms: O-Propan-2-yl S-[2-(dimethylamino)ethyl] (R)-methylphosphonothioate

(R)-O-Isopropyl S-2-dimethylaminoethyl methylphosphonothiolate

(-)-Phosphonothioic acid, methyl-, S-[2-(dimethylamino)ethyl] O-isopropyl ester

(-)-O-Isopropyl S-2-dimethylaminoethyl methylphosphonothiolate

(-)-Isopropyl S-2-dimethylaminoethyl methylphosphonothiolate

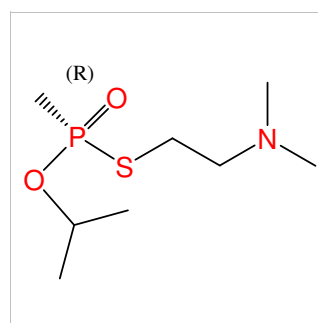

**Chemical name:** Isobutyl S-2-diethylaminoethyl methylphosphonothiolate

Schedule: 1A03

CAS RN: 159939-87-4

HS code: 2930.90

Key: 159939-87-4

Molecular formula: C<sub>11</sub>H<sub>26</sub>NO<sub>2</sub>PS

CAS Index Name: Phosphonothioic acid, methyl-, S-[2-(diethylamino)ethyl] O-(2-methylpropyl) ester

**IUPAC name:** Isobutyl S-2-diethylaminoethyl methylphosphonothioate

Synonyms: VR

R-VX

Phosphonothioic acid, methyl-, S-[2-(diethylamino)ethyl] O-2-methylpropyl ester

O-Isobutyl S-2-diethylaminoethyl methylphosphonothiolate

O-Isobutyl S-2-(diethylaminoethyl) methylphosphonothiolate

O-Isobutyl S-2-(diethylaminoethyl) methylphosphonothioate

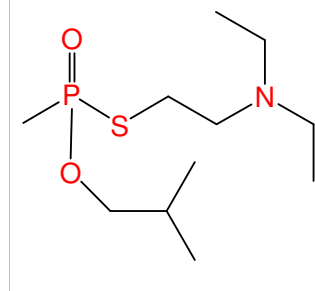

**Chemical name:** S-2 Diisopropylaminoethyl ethylphosphonothiolate

Schedule: 1A03

CAS RN: 161935-16-6

HS code: 2930.90

Key: 161935-16-6

Molecular formula: C<sub>10</sub>H<sub>24</sub>NO<sub>2</sub>PS

CAS Index Name: Phosphonothioic acid, ethyl-, S-[2-[bis(1-methylethyl)amino]ethyl] ester

**IUPAC name:** S-2 Diisopropylaminoethyl ethylphosphonothioate

Synonyms: O-Hydrogen S-2 diisopropylaminoethyl ethylphosphonothiolate

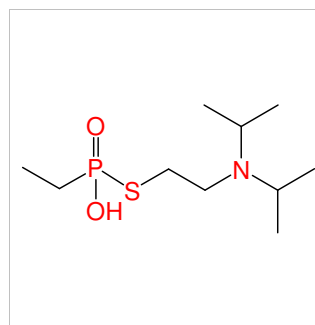

**Chemical name:** S-2 Diethylaminoethyl ethylphosphonothiolate

Schedule: 1A03

CAS RN: 161935-18-8

HS code: 2930.90

Key: 161935-18-8

Molecular formula: C<sub>8</sub>H<sub>20</sub>NO<sub>2</sub>PS

CAS Index Name: Phosphonothioic acid, ethyl-, S-[2-(diethylamino)ethyl] ester

**IUPAC name:** S-2 Diethylaminoethyl ethylphosphonothioate

Synonyms: O-Hydrogen S-2 diethylaminoethyl ethylphosphonothiolate

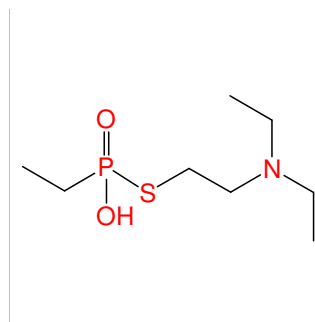

**Chemical name:** Isopropyl S-2-dimethylaminoethyl ethylphosphonothiolate

Schedule: 1A03

CAS RN: 162085-92-9

HS code: 2930.90

Key: 162085-92-9

Molecular formula: C<sub>9</sub>H<sub>22</sub>NO<sub>2</sub>PS

CAS Index Name: Phosphonothioic acid, ethyl-, S-[2-(dimethylamino)ethyl] O-(1-methylethyl) ester

**IUPAC name:** Isopropyl S-2-dimethylaminoethyl ethylphosphonothioate

Synonyms: Phosphonothioic acid, ethyl-, S-[2-(dimethylamino)ethyl] O-1-methylethyl ester

O-Isopropyl S-2-dimethylaminoethyl ethylphosphonothiolate

O-Isopropyl S-2-(dimethylamino)ethyl ethylphosphonothiolate

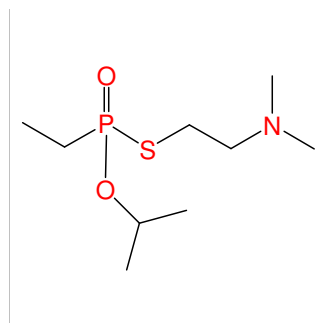

**Chemical name:** Isopropyl S-2-diethylaminoethyl ethylphosphonothiolate

Schedule: 1A03

CAS RN: 162085-93-0

HS code: 2930.90

Key: 162085-93-0

Molecular formula: C<sub>11</sub>H<sub>26</sub>NO<sub>2</sub>PS

CAS Index Name: Phosphonothioic acid, ethyl-, S-[2-(diethylamino)ethyl] O-(1-methylethyl) ester

**IUPAC name:** Isopropyl S-2-diethylaminoethyl ethylphosphonothioate

Synonyms: Phosphonothioic acid, ethyl-, S-[2-(diethylamino)ethyl] O-1-methylethyl ester

O-Isopropyl S-2-diethylaminoethyl ethylphosphonothiolate

O-Isopropyl S-2-(diethylamino)ethyl ethylphosphonothiolate

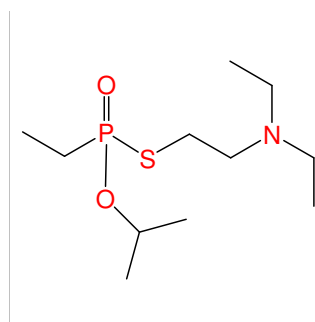

**Chemical name:** Methyl S-2-diisopropylaminoethyl ethylphosphonothiolate

Schedule: 1A03

CAS RN: 162085-94-1

HS code: 2930.90

Key: 162085-94-1

Molecular formula: C<sub>11</sub>H<sub>26</sub>NO<sub>2</sub>PS

CAS Index Name: Phosphonothioic acid, ethyl-, S-[2-(bis(1-methylethyl)amino)ethyl] O-methyl ester

**IUPAC name:** Methyl S-2-diisopropylaminoethyl ethylphosphonothioate

Synonyms: O-Methyl S-2-diisopropylaminoethyl ethylphosphonothiolate

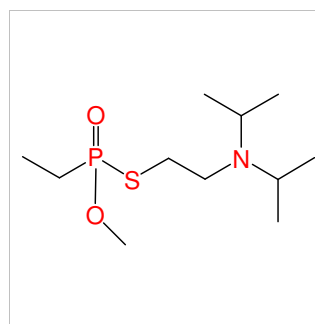

**Chemical name:** Isopropyl S-2-diisopropylaminoethyl ethylphosphonothiolate

Schedule: 1A03

CAS RN: 162085-95-2

HS code: 2930.90

Key: 162085-95-2

Molecular formula: C<sub>13</sub>H<sub>30</sub>NO<sub>2</sub>PS

CAS Index Name: Phosphonothioic acid, ethyl-, S-[2-(bis(1-methylethyl)amino)ethyl] O-(1-methylethyl) ester

**IUPAC name:** Isopropyl S-2-diisopropylaminoethyl ethylphosphonothioate

Synonyms: Phosphonothioic acid, ethyl-, S-[2-(bis(1-methylethyl)amino)ethyl] O-1-methylethyl es

O-Isopropyl S-2-diisopropylaminoethyl ethylphosphonothiolate

O-Isopropyl S-(2-diisopropylaminoethyl) ethylphosphonothiolate

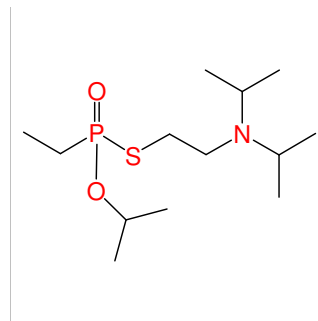

**Chemical name:** Methyl S-2-diethylaminoethyl ethylphosphonothiolate

Schedule: 1A03

CAS RN: 170800-77-8

HS code: 2930.90

Key: 170800-77-8

Molecular formula: C<sub>9</sub>H<sub>22</sub>NO<sub>2</sub>PS

CAS Index Name: Phosphonothioic acid, ethyl-, S-[2-(diethylamino)ethyl] O-methyl ester

**IUPAC name:** Methyl S-2-diethylaminoethyl ethylphosphonothioate

Synonyms: O-Methyl S-2-diethylaminoethyl ethylphosphonothiolate

O-Methyl S-2-(diethylamino)ethyl ethylphosphonothiolate

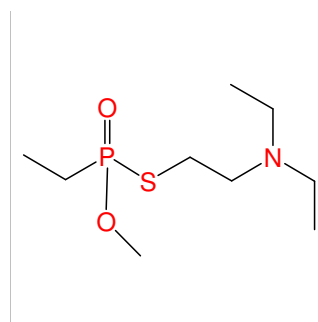

**Chemical name:** Isopropyl S-2-trimethylammoniummethyl methylphosphonothiolate iodide

Schedule: 1A03

CAS RN: 1866-98-4

HS code: 2930.90

Key: 1866-98-4

Molecular formula: C<sub>9</sub>H<sub>23</sub>INO<sub>2</sub>PS

CAS Index Name: Ethanaminium, N,N,N-trimethyl-2-[[methyl(1-methylethoxy)phosphinyl]thio]-, iodide

**IUPAC name:** 2-{[Isopropoxy(methyl)phosphoryl]thio}-N,N,N-trimethylethanaminium iodide

**Synonyms:** S-(2-Dimethylaminoethyl) isopropyl methylphosphonothiolate methyl iodide

S 40 (anticholinesterase)

S 40

Phosphonothioic acid, methyl-, O-isopropyl ester, S-ester with (2-mercaptoethyl)trimethylammonium iodide

O-Isopropyl S-2-trimethylammoniummethyl methylphosphonothiolate iodide

Ethanaminium, N,N,N-trimethyl-2-[(isopropoxymethylphosphinyl)thio]-, iodide

Ammonium, (2-mercaptoethyl)trimethyl-, iodide, S-ester with O-isopropyl methylphosphonothioate

(2-Mercaptoethyl)trimethylammonium iodide, S-ester with O-isopropyl methylphospho

(2-Mercaptoethyl)trimethylammonium iodide, isopropyl methylphosphonothioate

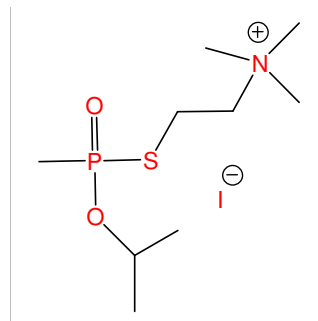

**Chemical name:** Methyl S-2-diisopropylaminoethyl methylphosphonothiolate

Schedule: 1A03

CAS RN: 198830-32-9

HS code: 2930.90

Key: 198830-32-9

Molecular formula: C<sub>10</sub>H<sub>24</sub>NO<sub>2</sub>PS

CAS Index Name: Phosphonothioic acid, methyl-, S-[2-(bis(1-methylethyl)amino)ethyl] O-methyl ester

**IUPAC name:** Methyl S-2-diisopropylaminoethyl methylphosphonothioate

**Synonyms:** O-Methyl S-2-diisopropylaminoethyl methylphosphonothiolate

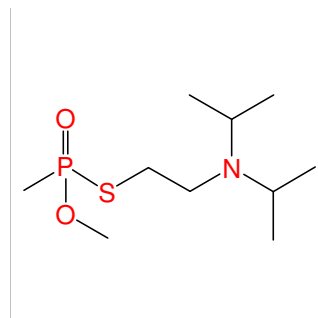



**Chemical name:** Pentyl S-2-diisopropylaminoethyl methylphosphonothiolate

Schedule: 1A03

CAS RN: 198830-36-3

HS code: 2930.90

Key: 198830-36-3

Molecular formula: C<sub>14</sub>H<sub>32</sub>NO<sub>2</sub>PS

CAS Index Name: Phosphonothioic acid, methyl-, S-[2-(bis(1-methylethyl)amino)ethyl] O-pentyl ester

**IUPAC name:** Pentyl S-2-diisopropylaminoethyl methylphosphonothioate

Synonyms: O-Pentyl S-2-diisopropylaminoethyl methylphosphonothiolate

O-n-Pentyl S-2-diisopropylaminoethyl methylphosphonothiolate

n-Pentyl S-2-diisopropylaminoethyl methylphosphonothiolate

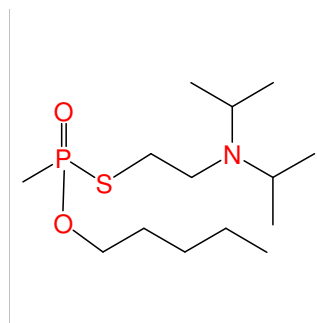

**Chemical name:** Pinacolyl S-2-diisopropylaminoethyl methylphosphonothiolate

Schedule: 1A03

CAS RN: 198830-38-5

HS code: 2930.90

Key: 198830-38-5

Molecular formula: C<sub>15</sub>H<sub>34</sub>NO<sub>2</sub>PS

CAS Index Name: Phosphonothioic acid, methyl-, S-[2-(bis(1-methylethyl)amino)ethyl] O-(1,2,2-trimethylpropyl) ester

**IUPAC name:** 1,2,2-Trimethylpropyl S-2-diisopropylaminoethyl methylphosphonothioate

Synonyms: Phosphonothioic acid, methyl-, S-[2-(bis(1-methylethyl)amino)ethyl] O-3,3-dimethylbutyl ester

O-Pinacolyl S-2-diisopropylaminoethyl methylphosphonothiolate

O-3,3-Dimethylbut-2-yl S-[2-(diisopropylamino)ethyl] methylphosphonothiolate

O-1,2,2-Trimethylpropyl S-[2-(diisopropylamino)ethyl] methylphosphonothiolate

3,3-Dimethylbutan-2-yl S-2-diisopropylaminoethyl methylphosphonothiolate

3,3-Dimethylbut-2-yl S-[2-(diisopropylamino)ethyl] methylphosphonothiolate

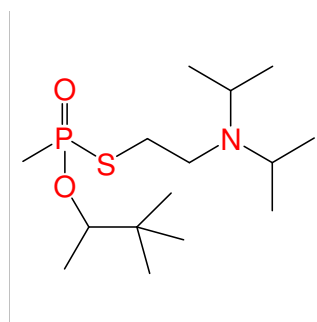

**Chemical name:** Methyl S-2-diethylaminoethyl methylphosphonothiolate

Schedule: 1A03

CAS RN: 203385-78-8

HS code: 2930.90

Key: 203385-78-8

Molecular formula: C<sub>8</sub>H<sub>20</sub>NO<sub>2</sub>PS

CAS Index Name: Phosphonothioic acid, methyl-, S-[2-(diethylamino)ethyl] O-methyl ester

**IUPAC name:** Methyl S-2-diethylaminoethyl methylphosphonothioate

Synonyms: O-Methyl S-2-diethylaminoethyl methylphosphonothiolate

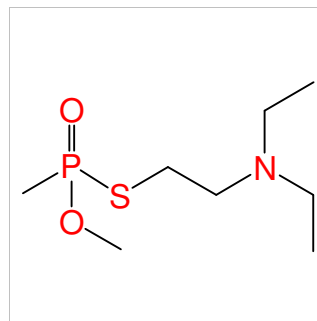

**Chemical name:** Isobutyl S-2-N-ethyl-N-methylaminoethyl methylphosphonothiolate

Schedule: 1A03

CAS RN: 203385-79-9

HS code: 2930.90

Key: 203385-79-9

Molecular formula: C<sub>10</sub>H<sub>24</sub>NO<sub>2</sub>PS

CAS Index Name: Phosphonothioic acid, methyl-, S-[2-(ethylmethylamino)ethyl] O-(2-methylpropyl) ester

**IUPAC name:**

Synonyms:

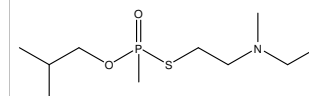

**Chemical name:** Ethyl S-2-dimethylaminoethyl methylphosphonothiolate

Schedule: 1A03

CAS RN: 20820-80-8

HS code: 2930.90

Key: 20820-80-8

Molecular formula: C<sub>7</sub>H<sub>18</sub>NO<sub>2</sub>PS

CAS Index Name: Phosphonothioic acid, methyl-, S-[2-(dimethylamino)ethyl] O-ethyl ester

**IUPAC name:** Ethyl S-2-dimethylaminoethyl methylphosphonothioate

Synonyms: O-Ethyl S-2-dimethylaminoethyl methylphosphonothiolate

O-Ethyl S-(dimethylaminoethyl) methylphosphonothioate

O-Ethyl S-(2-dimethylaminoethyl) methylphosphonothiolate

O-Ethyl S-(2-dimethylaminoethyl) methylphosphonothioate

Medemo

EDMM

EA 1699

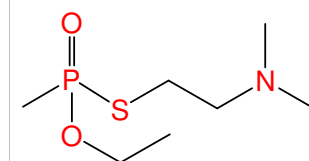

**Chemical name:** S-2-Diethylaminoethyl methylphosphonothiolate

Schedule: 1A03

CAS RN: 21068-51-9

HS code: 2930.90

Key: 21068-51-9

Molecular formula: C<sub>7</sub>H<sub>18</sub>NO<sub>2</sub>PS

CAS Index Name: Phosphonothioic acid, methyl-, S-[2-(diethylamino)ethyl] ester

**IUPAC name:** S-2-Diethylaminoethyl methylphosphonothioate

Synonyms: S-2-Diethylaminoethyl hydrogen methylphosphonothiolate

S-(2-Diethylaminoethyl) hydrogen methylphosphonothiolate

S 27 (pesticide)

S 27

O-Hydrogen S-2-diethylaminoethyl methylphosphonothiolate

O-Hydrogen S-(2-diethylaminoethyl) methylphosphonothiolate

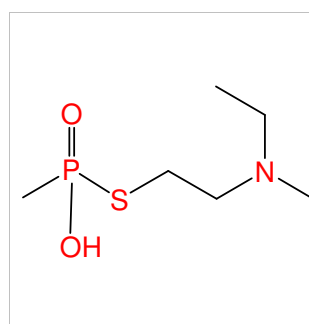

**Chemical name:** Isopropyl S-2-dimethylaminoethyl methylphosphonothiolate

Schedule: 1A03

CAS RN: 21068-52-0

HS code: 2930.90

Key: 21068-52-0

Molecular formula: C<sub>8</sub>H<sub>20</sub>NO<sub>2</sub>PS

CAS Index Name: Phosphonothioic acid, methyl-, S-[2-(dimethylamino)ethyl] O-(1-methylethyl) ester

**IUPAC name:** Isopropyl S-2-dimethylaminoethyl methylphosphonothioate

Synonyms: S-(2-Dimethylaminoethyl) isopropyl methylphosphonothiolate

S 36 (enzyme inhibitor)

S 36

Phosphonothioic acid, methyl-, S-[2-(dimethylamino)ethyl] O-isopropyl ester

Phosphonothioic acid, methyl-, S-[2-(dimethylamino)ethyl] O-1-methylethyl ester

O-Isopropyl S-2-dimethylaminoethyl methylphosphonothiolate

O-Isopropyl S-2-(dimethylamino)ethyl methylphosphonothiolate

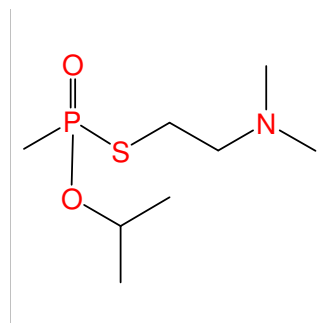

**Chemical name:** Ethyl S-2-diethylaminoethyl ethylphosphonothiolate

Schedule: 1A03

CAS RN: 21738-25-0

HS code: 2930.90

Key: 21738-25-0

Molecular formula: C<sub>10</sub>H<sub>24</sub>NO<sub>2</sub>PS

CAS Index Name: Phosphonothioic acid, ethyl-, S-[2-(diethylamino)ethyl] O-ethyl ester

**IUPAC name:** Ethyl S-2-diethylaminoethyl ethylphosphonothioate

Synonyms: S-(Diethylamino)ethyl O-ethyl ethylphosphonothioate

O-Ethyl S-diethylaminoethyl ethylphosphonothiolate

O-Ethyl S-diethylaminoethyl ethylphosphonothioate

O-Ethyl S-2-diethylaminoethyl ethylphosphonothiolate

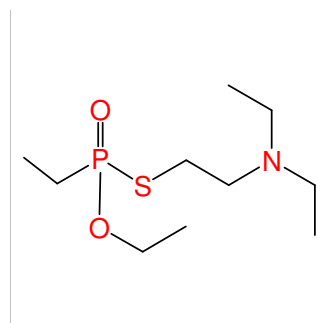

**Chemical name:** Ethyl S-2-diethylaminoethyl methylphosphonothiolate

Schedule: 1A03

CAS RN: 21770-86-5

HS code: 2930.90

Key: 21770-86-5

Molecular formula: C<sub>9</sub>H<sub>22</sub>NO<sub>2</sub>PS

CAS Index Name: Phosphonothioic acid, methyl-, S-[2-(diethylamino)ethyl] O-ethyl ester

**IUPAC name:** Ethyl S-2-diethylaminoethyl methylphosphonothioate

Synonyms: VM

S-[2-(Diethylamino)ethyl] O-ethyl methylphosphonothiolate

S-[2-(Diethylamino)ethyl] O-ethyl methylphosphonothioate

O-Ethyl S-2-diethylaminoethyl methylphosphonothiolate

O-Ethyl S-2-(diethylaminoethyl) methylphosphonothiolate

O-Ethyl S-(2-diethylaminoethyl) methylthiophosphonate

O-Ethyl S-(2-diethylaminoethyl) methylphosphonothiolate

Demo 3

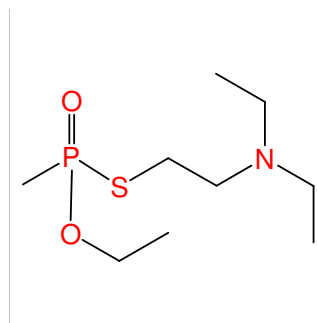

**Chemical name:** Ethyl S-2-dimethylaminoethyl propylphosphonothiolate

Schedule: 1A03

CAS RN: 218964-59-1

HS code: 2930.90

Key: 218964-59-1

Molecular formula: C<sub>9</sub>H<sub>22</sub>NO<sub>2</sub>PS

CAS Index Name: Phosphonothioic acid, propyl-, S-[2-(dimethylamino)ethyl] O-ethyl ester

**IUPAC name:** Ethyl S-2-dimethylaminoethyl propylphosphonothioate

Synonyms: S-[2-(Dimethylamino)ethyl] O-ethyl propylphosphonothioate

O-Ethyl S-2-dimethylaminoethyl propylphosphonothiolate

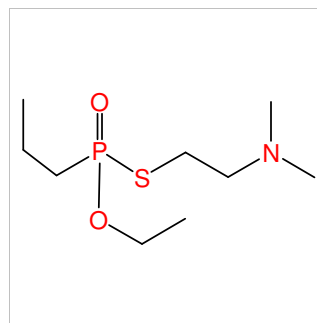

**Chemical name:** Ethyl S-2-diisopropylaminoethyl propylphosphonothiolate

Schedule: 1A03

CAS RN: 218964-60-4

HS code: 2930.90

Key: 218964-60-4

Molecular formula: C<sub>13</sub>H<sub>30</sub>NO<sub>2</sub>PS

CAS Index Name: Phosphonothioic acid, propyl-, S-[2-(bis(1-methylethyl)amino)ethyl] O-ethyl ester

**IUPAC name:** Ethyl S-2-diisopropylaminoethyl propylphosphonothioate

Synonyms: O-Ethyl S-2-diisopropylaminoethyl propylphosphonothiolate

O-Ethyl S-2-diisopropylaminoethyl n-propylphosphonothiolate

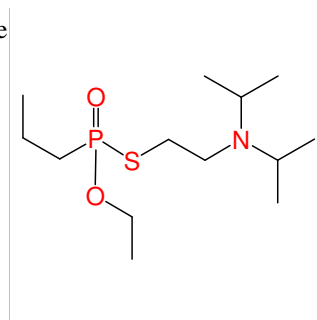

**Chemical name:** Ethyl S-2-diethylmethylammoniumethyl methylphosphonothiolate iodide

Schedule: 1A03

CAS RN: 220718-02-5

HS code: 2930.90

Key: 220718-02-5

Molecular formula: C<sub>10</sub>H<sub>25</sub>INO<sub>2</sub>PS

CAS Index Name: Ethanaminium, 2-[[ethoxy(methyl)phosphinyl]thio]-N,N-diethyl-N-methyl-, iodide

**IUPAC name:** 2-[[Ethoxy(methyl)phosphoryl]thio]-N,N-diethyl-N-methylethanaminium iodide

Synonyms: O-Ethyl S-2-diethylmethylammoniumethyl methylphosphonothiolate iodide

O-Ethyl S-2-(diethylmethylammonium)ethyl methylphosphonothiolate iodide

Ethanaminium, N,N-diethyl-N-methyl-2-[(ethoxymethylphosphinyl)thio]-, iodide

2-[[Ethoxy(methyl)phosphoryl]sulfanyl]-N,N-diethyl-N-methylethanaminium iodide

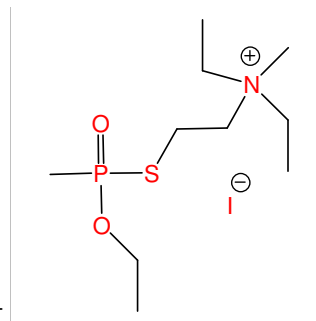

**Chemical name:** Ethyl S-2-diisopropylmethylammoniumethyl methylphosphonothiolate iodide

Schedule: 1A03

CAS RN: 220718-03-6

HS code: 2930.90

Key: 220718-03-6

Molecular formula: C<sub>12</sub>H<sub>29</sub>INO<sub>2</sub>PS

CAS Index Name: 2-Propanaminium, N-(2-[[ethoxy(methyl)phosphinyl]thio]ethyl)-N-(1-methylethyl)-N-methyl-, iodide

**IUPAC name:** N-(2-[[Ethoxy(methyl)phosphoryl]thio]ethyl)-N-isopropyl-N-methylpropan-2-aminium iodide

Synonyms: O-Ethyl S-2-diisopropylmethylammoniumethyl methylphosphonothiolate iodide

O-Ethyl S-2-(diisopropylmethylammonium)ethyl methylphosphonothiolate iodide

N-(2-[[Ethoxy(methyl)phosphoryl]sulfanyl]ethyl)-N-isopropyl-N-methylpropan-2-aminium iodide

Ethanaminium, N,N-diisopropyl-N-methyl-2-[(ethoxymethylphosphinyl)thio]-, iodide

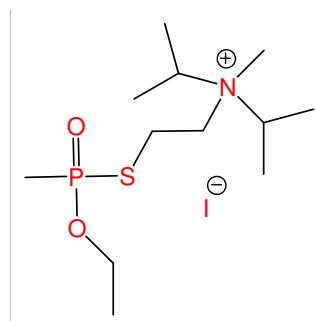

**Chemical name:** Ethyl S-2-trimethylammoniummethyl ethylphosphonothiolate iodide

Schedule: 1A03

CAS RN: 220718-05-8

HS code: 2930.90

Key: 220718-05-8

Molecular formula: C<sub>9</sub>H<sub>23</sub>INO<sub>2</sub>PS

CAS Index Name: Ethanaminium, 2-[[ethoxyethylphosphinyl]thio]-N,N,N-trimethyl-, iodide

**IUPAC name:** 2-[[Ethoxy(ethyl)phosphoryl]thio]-N,N,N-trimethylethanaminium iodide

Synonyms: O-Ethyl S-2-trimethylammoniummethyl ethylphosphonothiolate iodide

O-Ethyl S-2-(trimethylammonium)ethyl ethylphosphonothiolate iodide

Ethanaminium, N,N,N-trimethyl-2-[(ethoxyethylphosphinyl)thio]-, iodide

2-[[Ethoxy(ethyl)phosphoryl]sulfanyl]-N,N,N-trimethylethanaminium iodide

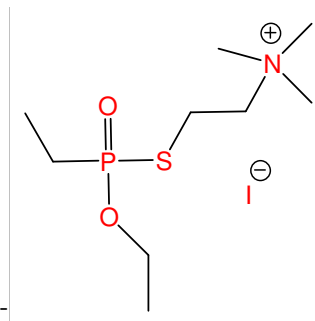

**Chemical name:** Isopropyl S-2 trimethylammoniummethyl ethylphosphonothiolate iodide

Schedule: 1A03

CAS RN: 220718-06-9

HS code: 2930.90

Key: 220718-06-9

Molecular formula: C<sub>10</sub>H<sub>25</sub>INO<sub>2</sub>PS

CAS Index Name: Ethanaminium, 2-[[ethyl(1-methylethoxy)phosphinyl]thio]-N,N,N-trimethyl-, iodide

**IUPAC name:** 2-[[Ethyl(isopropoxy)phosphoryl]thio]-N,N,N-trimethylethanaminium iodide

Synonyms: O-Isopropyl S-2-trimethylammoniummethyl ethylphosphonothiolate iodide

O-Isopropyl S-2-(trimethylammonium)ethyl ethylphosphonothiolate iodide

O-Isopropyl S-2 (trimethylammonium)ethyl ethylphosphonothiolate iodide

Ethanaminium, N,N,N-trimethyl-2-[(ethylisopropoxyphosphinyl)thio]-, iodide

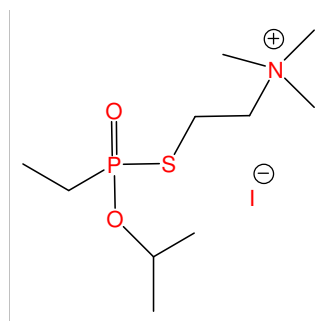

**Chemical name:** Cyclopentyl S-2-dimethylaminoethyl methylphosphonothiolate

Schedule: 1A03

CAS RN: 22925-98-0

HS code: 2930.90

Key: 22925-98-0

Molecular formula: C<sub>10</sub>H<sub>22</sub>NO<sub>2</sub>PS

CAS Index Name: Phosphonothioic acid, methyl-, S-[2-(dimethylamino)ethyl] O-cyclopentyl ester

**IUPAC name:** Cyclopentyl S-2-dimethylaminoethyl methylphosphonothioate

Synonyms: O-Cyclopentyl S-2-dimethylaminoethyl methylphosphonothiolate

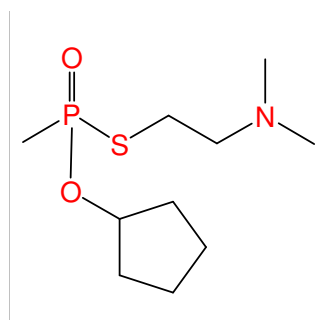

**Chemical name:** Ethyl S-2-triethylammoniummethyl ethylphosphonothiolate iodide

**Schedule:** 1A03

**CAS RN:** 24578-82-3

**HS code:** 2930.90

**Key:** 24578-82-3

**Molecular formula:** C<sub>12</sub>H<sub>29</sub>INO<sub>2</sub>PS

**CAS Index Name:** Ethanaminium, 2-[(ethoxy)ethylphosphinyl]thio}-N,N,N-triethyl-, iodide

**IUPAC name:** 2-{[Ethoxy(ethyl)phosphoryl]thio}-N,N,N-triethylethanaminium iodide

**Synonyms:** O-Ethyl S-2-triethylammoniummethyl ethylphosphonothiolate iodide

O-Ethyl S-2-(triethylammonium)ethyl ethylphosphonothiolate iodide

Ethanaminium, N,N,N-triethyl-2-[(ethoxyethylphosphinyl)thio]-, iodide

2-{[Ethoxy(ethyl)phosphoryl]sulfanyl}-N,N,N-triethylethanaminium iodide

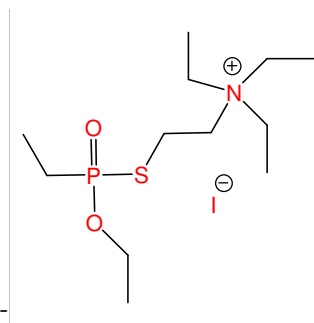

**Chemical name:** Ethyl S-2-trimethylammoniummethyl methylphosphonothiolate iodide

**Schedule:** 1A03

**CAS RN:** 2478-92-4

**HS code:** 2930.90

**Key:** 2478-92-4

**Molecular formula:** C<sub>8</sub>H<sub>21</sub>NO<sub>2</sub>PS.I

**CAS Index Name:** Ethanaminium, 2-[(ethoxymethylphosphinyl)thio]-N,N,N-trimethyl-, iodide

**IUPAC name:** 2-[(Ethoxymethylphosphoryl)thio]-N,N,N-trimethylethanaminium iodide

**Synonyms:** O-Ethyl S-2-trimethylammoniummethyl methylphosphonothiolate iodide

O-Ethyl S-2 (trimethylammonium)ethyl methylphosphonothiolate iodide

2-{[Ethoxy(methyl)phosphoryl]sulfanyl}-N,N,N-trimethylethanaminium iodide

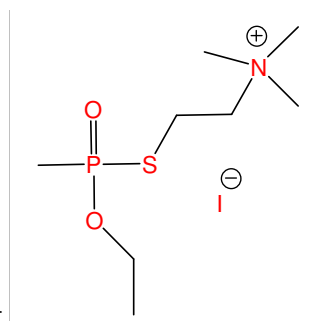

**Chemical name:** (R)-Isopropyl S-2-trimethylammoniummethyl methylphosphonothiolate

Schedule: 1A03

CAS RN: 26348-71-0

HS code: 2930.90

Key: 26348-71-0

Molecular formula: C<sub>9</sub>H<sub>23</sub>INO<sub>2</sub>PS

CAS Index Name: Ethanaminium, N,N,N-trimethyl-2-[[methyl(1-methylethoxy)phosphinyl]thio]-, iodide, (R)-

**IUPAC name:** (R)-2-[[Isopropoxy(methyl)phosphoryl]thio]-N,N,N-trimethylethanaminium iodide

**Synonyms:** Phosphonothioic acid, methyl-, O-isopropyl S-ester with (2-mercaptoethyl)trimethylammonium iodide, (R)-(-)-

Phosphonothioic acid, methyl-, O-isopropyl ester, S-ester with (2-mercaptoethyl)trimethylammonium iodide, (-)-

Ammonium, (2-mercaptoethyl)trimethyl-, iodide, isopropyl methylphosphonate, (R)-(-)

(R)-2-[[Isopropoxy(methyl)phosphoryl]sulfanyl]-N,N,N-trimethylethanaminium iodide

(R) Ethanaminium, N,N,N-trimethyl-2-[(isopropoxymethylphosphinyl)thio]-, iodide

(-)-Isopropyl S-2-trimethylammoniummethyl methylphosphonothioate iodide

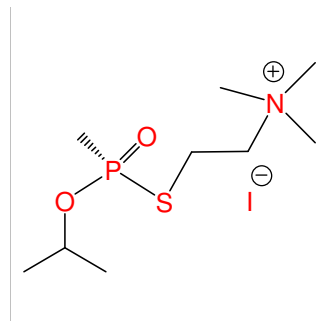

**Chemical name:** Methyl S-2-N-isopropyl-N-methylethylamino methylphosphonothiolate

Schedule: 1A03

CAS RN: 288578-13-2

HS code: 2930.90

Key: 288578-13-2

Molecular formula: C<sub>8</sub>H<sub>21</sub>NO<sub>2</sub>PS

CAS Index Name: Phosphonothioic acid, methyl-, O-methyl S-[2-[methyl(1-methylethyl)amino]ethyl] ester

**IUPAC name:**

Synonyms:

**Chemical name:** Methyl S-2-N-ethyl-N-isopropylaminoethyl methylphosphonothiolate

Schedule: 1A03

CAS RN: 288578-15-4

HS code: 2930.90

Key: 288578-15-4

Molecular formula: C<sub>9</sub>H<sub>22</sub>NO<sub>2</sub>PS

CAS Index Name: Phosphonothioic acid, methyl-, S-[2-[ethyl(1-methylethyl)amino]ethyl] O-methyl ester

**IUPAC name:**

Synonyms:

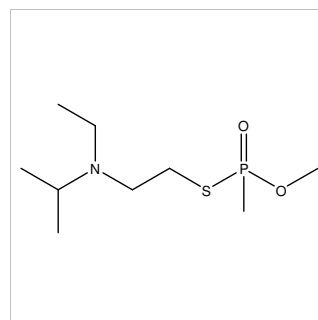



**Chemical name:** tert-Butyl S-2-diethylaminoethyl methylphosphonothiolate

Schedule: 1A03

CAS RN: 288578-18-7

HS code: 2930.90

Key: 288578-18-7

Molecular formula: C<sub>11</sub>H<sub>26</sub>NO<sub>2</sub>PS

CAS Index Name: Phosphonothioic acid, methyl-, S-[2-(diethylamino)ethyl] O-(1,1-dimethylethyl) ester

**IUPAC name:** tert-Butyl S-2-diethylaminoethyl methylphosphonothioate

Synonyms: O-tert-Butyl S-2-diethylaminoethyl methylphosphonothiolate

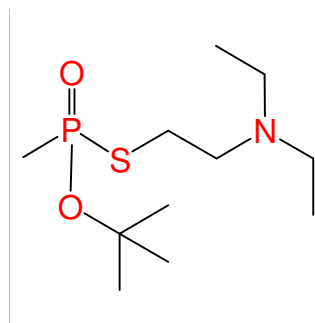

**Chemical name:** S-2-Dipropylaminoethyl methylphosphonothiolate

Schedule: 1A03

CAS RN: 30102-97-7

HS code: 2930.90

Key: 30102-97-7

Molecular formula: C<sub>9</sub>H<sub>22</sub>NO<sub>2</sub>PS

CAS Index Name: Phosphonothioic acid, methyl-, S-[2-(dipropylamino)ethyl] ester

**IUPAC name:** S-2-Dipropylaminoethyl methylphosphonothioate

Synonyms: O-Hydrogen S-2-dipropylaminoethyl methylphosphonothiolate  
Hydrogen S-2-di-n-propylaminoethyl methylphosphonothioate

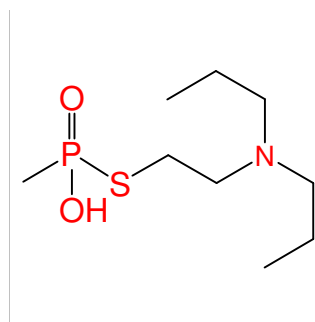

**Chemical name:** S-2-Dimethylaminoethyl methylphosphonothiolate

Schedule: 1A03

CAS RN: 34256-71-8

HS code: 2930.90

Key: 34256-71-8

Molecular formula: C<sub>5</sub>H<sub>14</sub>NO<sub>2</sub>PS

CAS Index Name: Phosphonothioic acid, methyl-, S-[2-(dimethylamino)ethyl] ester

**IUPAC name:** S-2-Dimethylaminoethyl methylphosphonothioate

Synonyms: S-(2-Dimethylaminoethyl) hydrogen methylphosphonothiolate  
O-Hydrogen S-2-dimethylaminoethyl methylphosphonothiolate

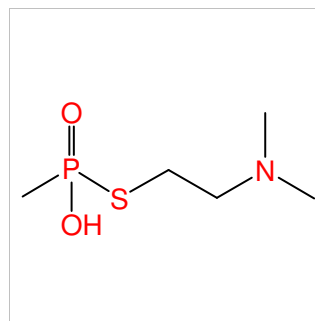

**Chemical name:** Butyl S-2-diethylaminoethyl methylphosphonothiolate

Schedule: 1A03

CAS RN: 468712-10-9

HS code: 2930.90

Key: 468712-10-9

Molecular formula: C<sub>11</sub>H<sub>26</sub>NO<sub>2</sub>PS

CAS Index Name: Phosphonothioic acid, methyl-, S-[2-(diethylamino)ethyl] O-butyl ester

**IUPAC name:** Butyl S-2-diethylaminoethyl methylphosphonothioate

Synonyms: O-n-Butyl S-2-diethylaminoethyl methylphosphonothiolate

O-Butyl S-2-diethylaminoethyl methylphosphonothiolate

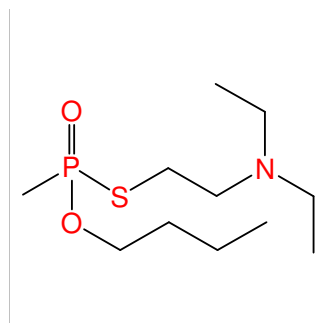

**Chemical name:** sec-Butyl S-2-diethylaminoethyl methylphosphonothiolate

Schedule: 1A03

CAS RN: 468712-11-0

HS code: 2930.90

Key: 468712-11-0

Molecular formula: C<sub>11</sub>H<sub>26</sub>NO<sub>2</sub>PS

CAS Index Name: Phosphonothioic acid, methyl-, S-[2-(diethylamino)ethyl] O-(1-methylpropyl) ester

**IUPAC name:** sec-Butyl S-2-diethylaminoethyl methylphosphonothioate

Synonyms: Phosphonothioic acid, methyl-, S-[2-(diethylamino)ethyl] O-1-methylpropyl ester

O-sec-Butyl S-2-diethylaminoethyl methylphosphonothiolate

Butan-2-yl S-2-diethylaminoethyl methylphosphonothiolate

But-2-yl S-2-diethylaminoethyl methylphosphonothiolate

1-Methylpropyl S-2-diethylaminoethyl methylphosphonothiolate

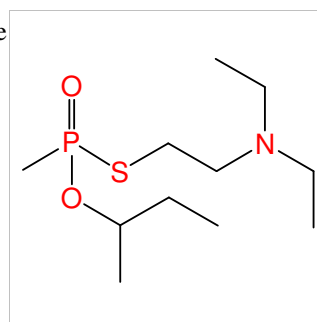

**Chemical name:** 3-Methylbutyl S-2-diethylaminoethyl methylphosphonothiolate

Schedule: 1A03

CAS RN: 468712-12-1

HS code: 2930.90

Key: 468712-12-1

Molecular formula: C<sub>12</sub>H<sub>28</sub>NO<sub>2</sub>PS

CAS Index Name: Phosphonothioic acid, methyl-, S-[2-(diethylamino)ethyl] O-3-methylbutyl ester

**IUPAC name:** 3-Methylbutyl S-2-diethylaminoethyl methylphosphonothioate

Synonyms: O-Isopentyl S-2-diethylaminoethyl methylphosphonothiolate

O-3-Methylbutyl S-2-diethylaminoethyl methylphosphonothiolate

Isopentyl S-2-diethylaminoethyl methylphosphonothiolate

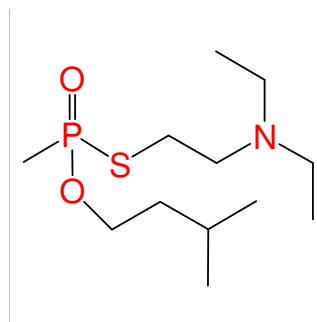

**Chemical name:** Pinacolyl S-2-diethylaminoethyl methylphosphonothiolate

Schedule: 1A03

CAS RN: 468712-13-2

HS code: 2930.90

Key: 468712-13-2

Molecular formula: C<sub>13</sub>H<sub>30</sub>NO<sub>2</sub>PS

CAS Index Name: Phosphonothioic acid, methyl-, S-[2-(diethylamino)ethyl] O-(1,2,2-trimethylpropyl) ester

**IUPAC name:** 1,2,2-Trimethylpropyl S-2-diethylaminoethyl methylphosphonothioate

Synonyms: Phosphonothioic acid, methyl-, S-[2-(diethylamino)ethyl] O-3,3-dimethylbut-2-yl ester

O-Pinacolyl S-2-diethylaminoethyl methylphosphonothiolate

3,3-Dimethylbutan-2-yl S-2-diethylaminoethyl methylphosphonothiolate

3,3-Dimethylbut-2-yl S-2-diethylaminoethyl methylphosphonothiolate

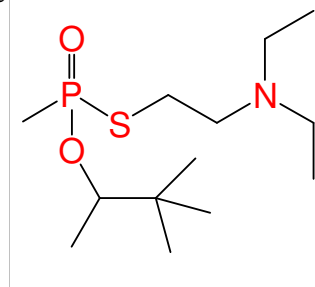

**Chemical name:** 2-Methylpentyl S-2-diethylaminoethyl methylphosphonothiolate

Schedule: 1A03

CAS RN: 468712-14-3

HS code: 2930.90

Key: 468712-14-3

Molecular formula: C<sub>13</sub>H<sub>30</sub>NO<sub>2</sub>PS

CAS Index Name: Phosphonothioic acid, methyl-, S-[2-(diethylamino)ethyl] O-(2-methylpentyl) ester

**IUPAC name:** 2-Methylpentyl S-2-diethylaminoethyl methylphosphonothioate

Synonyms: O-2-Methylpentyl S-2-diethylaminoethyl methylphosphonothiolate

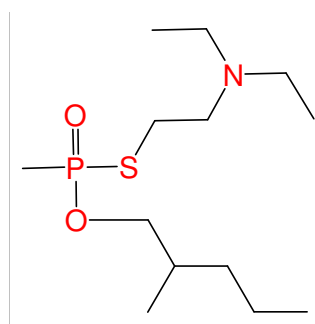

**Chemical name:** Hexyl S-2-diethylaminoethyl methylphosphonothiolate

Schedule: 1A03

CAS RN: 468712-15-4

HS code: 2930.90

Key: 468712-15-4

Molecular formula: C<sub>13</sub>H<sub>30</sub>NO<sub>2</sub>PS

CAS Index Name: Phosphonothioic acid, methyl-, S-[2-(diethylamino)ethyl] O-hexyl ester

**IUPAC name:** Hexyl S-2-diethylaminoethyl methylphosphonothioate

Synonyms: O-Hexyl S-[2-(diethylamino)ethyl] methylphosphonothiolate

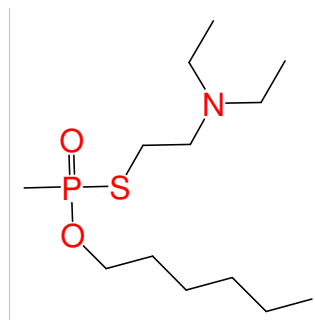

**Chemical name:** Heptyl S-2-diethylaminoethyl methylphosphonothiolate

Schedule: 1A03

CAS RN: 468712-17-6

HS code: 2930.90

Key: 468712-17-6

Molecular formula: C<sub>14</sub>H<sub>32</sub>NO<sub>2</sub>PS

CAS Index Name: Phosphonothioic acid, methyl-, S-[2-(diethylamino)ethyl] O-heptyl ester

**IUPAC name:** Heptyl S-2-diethylaminoethylmethylphosphonothioate

Synonyms: O-Heptyl S-[2-(diethylamino)ethyl] methylphosphonothiolate

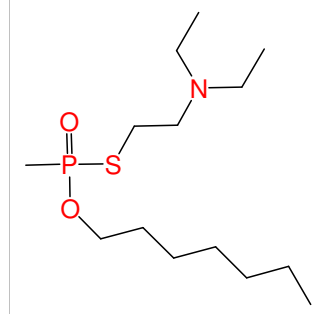

**Chemical name:** Methyl S-2-dimethylaminoethyl ethylphosphonothiolate

Schedule: 1A03

CAS RN: 468712-18-7

HS code: 2930.90

Key: 468712-18-7

Molecular formula: C<sub>7</sub>H<sub>18</sub>NO<sub>2</sub>PS

CAS Index Name: Phosphonothioic acid, ethyl-, S-[2-(dimethylamino)ethyl] O-methyl ester

**IUPAC name:** Methyl S-2-dimethylaminoethyl ethylphosphonothioate

Synonyms: O-Methyl S-2-dimethylaminoethyl ethylphosphonothiolate

O-Methyl S-2-(dimethylamino)ethyl ethylphosphonothiolate

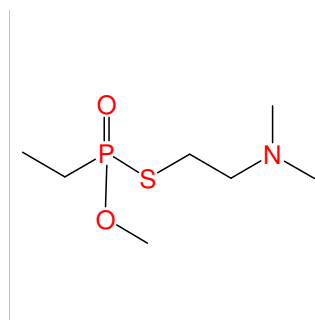

**Chemical name:** Propyl S-2-diethylaminoethyl ethylphosphonothiolate

Schedule: 1A03

CAS RN: 468712-19-8

HS code: 2930.90

Key: 468712-19-8

Molecular formula: C<sub>11</sub>H<sub>26</sub>NO<sub>2</sub>PS

CAS Index Name: Phosphonothioic acid, ethyl-, S-[2-(diethylamino)ethyl] O-propyl ester

**IUPAC name:** Propyl S-2-diethylaminoethyl ethylphosphonothioate

Synonyms: O-Propyl S-2-diethylaminoethyl ethylphosphonothiolate

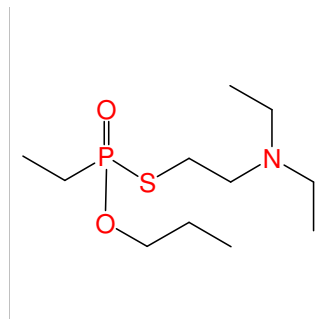

**Chemical name:** Butyl S-2-diethylaminoethyl ethylphosphonothiolate

Schedule: 1A03

CAS RN: 468712-20-1

HS code: 2930.90

Key: 468712-20-1

Molecular formula: C<sub>12</sub>H<sub>28</sub>NO<sub>2</sub>PS

CAS Index Name: Phosphonothioic acid, ethyl-, S-[2-(diethylamino)ethyl] O-butyl ester

**IUPAC name:** Butyl S-2-diethylaminoethyl ethylphosphonothioate

Synonyms: O-Butyl S-2-diethylaminoethyl ethylphosphonothiolate

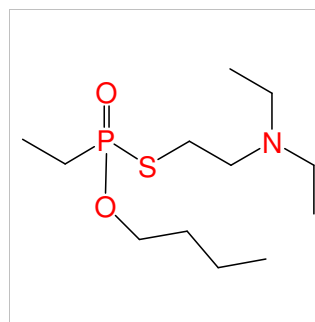

**Chemical name:** Isobutyl S-2-diethylaminoethyl ethylphosphonothiolate

Schedule: 1A03

CAS RN: 468712-21-2

HS code: 2930.90

Key: 468712-21-2

Molecular formula: C<sub>12</sub>H<sub>28</sub>NO<sub>2</sub>PS

CAS Index Name: Phosphonothioic acid, ethyl-, S-[2-(diethylamino)ethyl] O-(2-methylpropyl) ester

**IUPAC name:** Isobutyl S-2-diethylaminoethyl ethylphosphonothioate

Synonyms: Phosphonothioic acid, ethyl-, S-[2-(diethylamino)ethyl] O-2-methylpropyl ester

O-Isobutyl S-2-diethylaminoethyl ethylphosphonothiolate

O-2-Methylpropyl S-2-diethylaminoethyl ethylphosphonothiolate

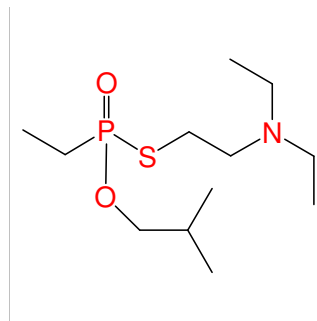

**Chemical name:** sec-Butyl S-2-diethylaminoethyl ethylphosphonothiolate

Schedule: 1A03

CAS RN: 468712-22-3

HS code: 2930.90

Key: 468712-22-3

Molecular formula: C<sub>12</sub> H<sub>28</sub> N O<sub>2</sub> P S

CAS Index Name: Phosphonothioic acid, ethyl-, S-[2-(diethylamino)ethyl] O-(1-methylpropyl) ester

**IUPAC name:** sec-Butyl S-2-diethylaminoethyl ethylphosphonothioate

Synonyms: Phosphonothioic acid, ethyl-, S-[2-(diethylamino)ethyl] O-1-methylpropyl ester

O-sec-Butyl S-2-diethylaminoethyl ethylphosphonothiolate

Butan-2-yl S-2-diethylaminoethyl ethylphosphonothiolate

But-2-yl S-2-diethylaminoethyl ethylphosphonothiolate

1-Methylpropyl S-2-diethylaminoethyl ethylphosphonothiolate

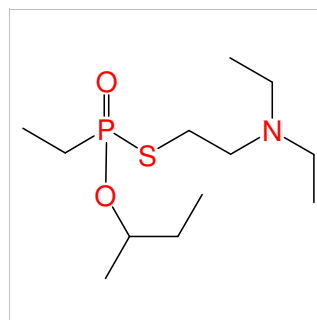

**Chemical name:** 3-Methylbutyl S-2-diethylaminoethyl ethylphosphonothiolate

Schedule: 1A03

CAS RN: 468712-23-4

HS code: 2930.90

Key: 468712-23-4

Molecular formula: C<sub>13</sub>H<sub>30</sub>NO<sub>2</sub>PS

CAS Index Name: Phosphonothioic acid, ethyl-, S-[2-(diethylamino)ethyl] O-(3-methylbutyl) ester

**IUPAC name:** Isopentyl S-2-diethylaminoethyl ethylphosphonothioate

Synonyms: O-Isopentyl S-2-diethylaminoethyl ethylphosphonothiolate

O-3-Methylbutyl S-2-diethylaminoethyl ethylphosphonothiolate

Isopentyl S-2-diethylaminoethyl ethylphosphonothiolate

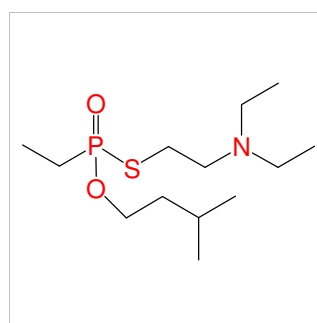

**Chemical name:** Cyclopentyl S-2-diethylaminoethyl ethylphosphonothiolate

Schedule: 1A03

CAS RN: 468712-24-5

HS code: 2930.90

Key: 468712-24-5

Molecular formula: C<sub>13</sub>H<sub>28</sub>NO<sub>2</sub>PS

CAS Index Name: Phosphonothioic acid, ethyl-, S-[2-(diethylamino)ethyl] O-cyclopentyl ester

**IUPAC name:** Cyclopentyl S-2-diethylaminoethyl ethylphosphonothioate

Synonyms: O-Cyclopentyl S-[2-(diethylamino)ethyl] ethylphosphonothiolate

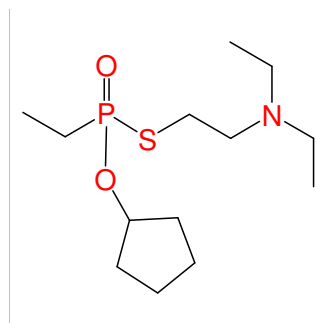

**Chemical name:** Hexyl S-2-diethylaminoethyl ethylphosphonothiolate

Schedule: 1A03

CAS RN: 468712-25-6

HS code: 2930.90

Key: 468712-25-6

Molecular formula: C<sub>14</sub>H<sub>32</sub>NO<sub>2</sub>PS

CAS Index Name: Phosphonothioic acid, ethyl-, S-[2-(diethylamino)ethyl] O-hexyl ester

**IUPAC name:** Hexyl S-2-diethylaminoethyl ethylphosphonothioate

Synonyms: O-Hexyl S-[2-(diethylamino)ethyl] ethylphosphonothiolate

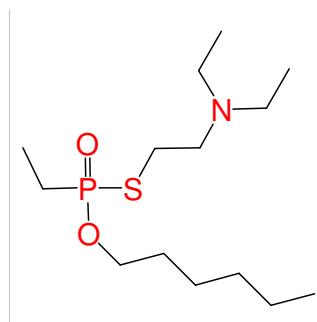

**Chemical name:** Heptyl S-2-diethylaminoethyl ethylphosphonothiolate

Schedule: 1A03

CAS RN: 468712-29-0

HS code: 2930.90

Key: 468712-29-0

Molecular formula: C<sub>15</sub>H<sub>34</sub>NO<sub>2</sub>PS

CAS Index Name: Phosphonothioic acid, ethyl-, S-[2-(diethylamino)ethyl] O-heptyl ester

**IUPAC name:** Heptyl S-2-diethylaminoethyl ethylphosphonothioate

Synonyms: O-Heptyl S-[2-(diethylamino)ethyl] ethylphosphonothiolate

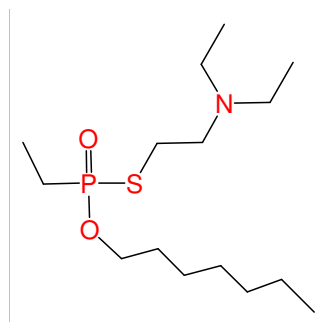

**Chemical name:** Octyl S-2-diethylaminoethyl ethylphosphonothiolate

Schedule: 1A03

CAS RN: 468712-30-3

HS code: 2930.90

Key: 468712-30-3

Molecular formula: C<sub>16</sub>H<sub>36</sub>NO<sub>2</sub>PS

CAS Index Name: Phosphonothioic acid, ethyl-, S-[2-(diethylamino)ethyl] O-octyl ester

**IUPAC name:** Octyl S-2-diethylaminoethyl ethylphosphonothioate

Synonyms: O-Octyl S-[2-(diethylamino)ethyl] ethylphosphonothiolate

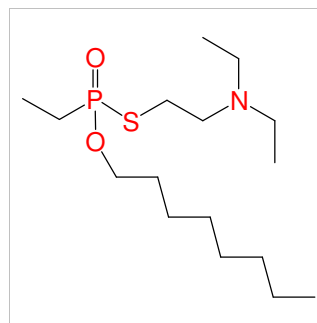

**Chemical name:** Nonyl S-2-diethylaminoethyl ethylphosphonothiolate

Schedule: 1A03

CAS RN: 468712-32-5

HS code: 2930.90

Key: 468712-32-5

Molecular formula: C<sub>17</sub>H<sub>38</sub>NO<sub>2</sub>PS

CAS Index Name: Phosphonothioic acid, ethyl-, S-[2-(diethylamino)ethyl] O-nonyl ester

**IUPAC name:** Nonyl S-2-diethylaminoethyl ethylphosphonothioate

Synonyms: O-Nonyl S-[2-(diethylamino)ethyl] ethylphosphonothiolate

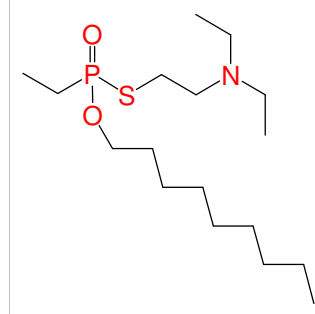

**Chemical name:** Decyl S-2-diethylaminoethyl ethylphosphonothiolate

Schedule: 1A03

CAS RN: 468712-33-6

HS code: 2930.90

Key: 468712-33-6

Molecular formula: C<sub>18</sub>H<sub>40</sub>NO<sub>2</sub>PS

CAS Index Name: Phosphonothioic acid, ethyl-, S-[2-(diethylamino)ethyl] O-decyl ester

**IUPAC name:** Decyl S-2-diethylaminoethyl ethylphosphonothioate

Synonyms: O-Decyl S-[2-(diethylamino)ethyl] ethylphosphonothiolate

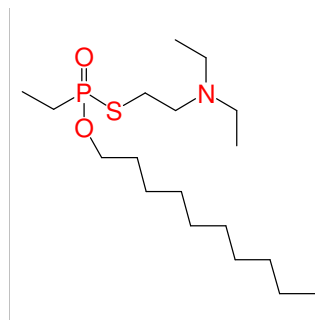

**Chemical name:** Isopropyl S-2-diethylaminoethyl propylphosphonothiolate

Schedule: 1A03

CAS RN: 468712-34-7

HS code: 2930.90

Key: 468712-34-7

Molecular formula: C<sub>12</sub>H<sub>28</sub>NO<sub>2</sub>PS

CAS Index Name: Phosphonothioic acid, propyl-, S-[2-(diethylamino)ethyl] O-(1-methylethyl) ester

**IUPAC name:** Isopropyl S-2-diethylaminoethyl propylphosphonothioate

Synonyms: Phosphonothioic acid, propyl-, S-[2-(diethylamino)ethyl] O-1-methylethyl ester

O-Isopropyl S-2-diethylaminoethyl propylphosphonothiolate

O-1-Methylethyl S-2-diethylaminoethyl propylphosphonothiolate

1-Methylethyl S-2-diethylaminoethyl propylphosphonothiolate

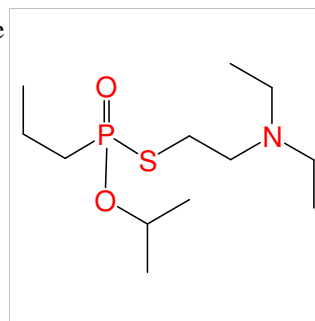

**Chemical name:** Butyl S-2-diethylaminoethyl propylphosphonothiolate

Schedule: 1A03

CAS RN: 468712-35-8

HS code: 2930.90

Key: 468712-35-8

Molecular formula: C<sub>13</sub>H<sub>30</sub>NO<sub>2</sub>PS

CAS Index Name: Phosphonothioic acid, propyl-, S-[2-(diethylamino)ethyl] O-butyl ester

**IUPAC name:** Butyl S-2-diethylaminoethyl propylphosphonothioate

Synonyms: O-Butyl S-2-diethylaminoethyl propylphosphonothiolate

Butyl S-[2-(diethylamino)ethyl] propylphosphonothiolate

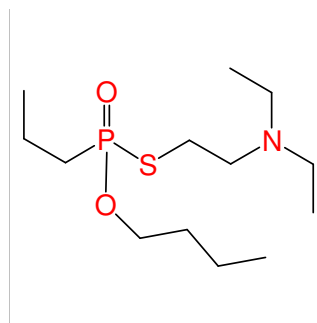

**Chemical name:** Isobutyl S-2-diethylaminoethyl propylphosphonothiolate

Schedule: 1A03

CAS RN: 468712-36-9

HS code: 2930.90

Key: 468712-36-9

Molecular formula: C<sub>13</sub>H<sub>30</sub>NO<sub>2</sub>PS

CAS Index Name: Phosphonothioic acid, propyl-, S-[2-(diethylamino)ethyl] O-(2-methylpropyl) ester

**IUPAC name:** Isobutyl S-2-diethylaminoethyl propylphosphonothioate

Synonyms: Phosphonothioic acid, propyl-, S-[2-(diethylamino)ethyl] O-2-methylpropyl ester

O-Isobutyl S-2-diethylaminoethyl propylphosphonothiolate

2-Methylpropyl S-2-diethylaminoethyl propylphosphonothiolate

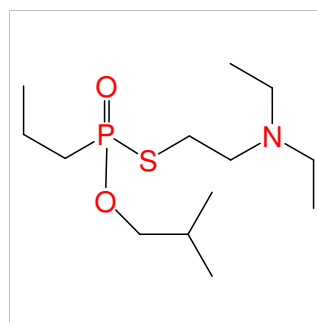

**Chemical name:** sec-Butyl S-2-diethylaminoethyl propylphosphonothiolate

Schedule: 1A03

CAS RN: 468712-37-0

HS code: 2930.90

Key: 468712-37-0

Molecular formula: C<sub>13</sub>H<sub>30</sub>NO<sub>2</sub>PS

CAS Index Name: Phosphonothioic acid, propyl-, S-[2-(diethylamino)ethyl] O-(1-methylpropyl) ester

**IUPAC name:** sec-Butyl S-2-diethylaminoethyl propylphosphonothioate

Synonyms: Phosphonothioic acid, propyl-, S-[2-(diethylamino)ethyl] O-1-methylpropyl ester

O-sec-Butyl S-2-diethylaminoethyl propylphosphonothiolate

O-1-Methylpropyl S-2-diethylaminoethyl propylphosphonothiolate

1-Methylpropyl S-2-diethylaminoethyl propylphosphonothiolate

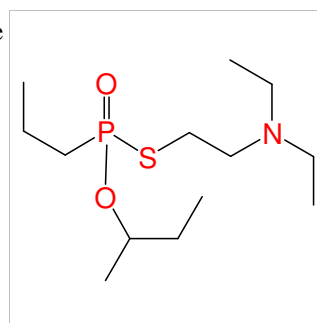



**Chemical name:** Pentyl S-2-diethylaminoethyl propylphosphonothiolate

Schedule: 1A03

CAS RN: 468712-38-1

HS code: 2930.90

Key: 468712-38-1

Molecular formula: C<sub>14</sub>H<sub>32</sub>NO<sub>2</sub>PS

CAS Index Name: Phosphonothioic acid, propyl-, S-[2-(diethylamino)ethyl] O-pentyl ester

**IUPAC name:** S-[2-(diethylamino)ethyl] O-pentyl propylphosphonothioate

Synonyms:

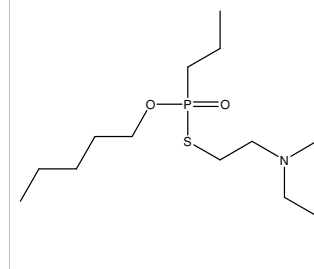

**Chemical name:** Cyclopentyl S-2-diethylaminoethyl propylphosphonothiolate

Schedule: 1A03

CAS RN: 468712-39-2

HS code: 2930.90

Key: 468712-39-2

Molecular formula: C<sub>14</sub>H<sub>30</sub>NO<sub>2</sub>PS

CAS Index Name: Phosphonothioic acid, propyl-, O-cyclopentyl S-[2-(diethylamino)ethyl] ester

**IUPAC name:** O-Cyclopentyl S-[2-(diethylamino)ethyl] propylphosphonothioate

Synonyms:

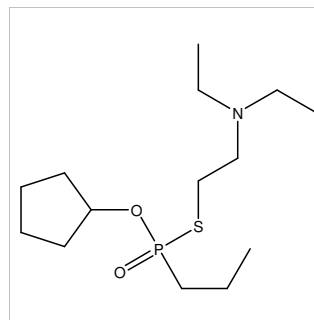

**Chemical name:** Pinacolyl S-2-diethylaminoethyl propylphosphonothiolate

Schedule: 1A03

CAS RN: 468712-40-5

HS code: 2930.90

Key: 468712-40-5

Molecular formula: C<sub>15</sub>H<sub>34</sub>NO<sub>2</sub>PS

CAS Index Name: Phosphonothioic acid, propyl-, S-[2-(diethylamino)ethyl] O-(1,2,2-trimethylpropyl) ester

**IUPAC name:** S-[2-(diethylamino)ethyl] O-(3,3-dimethylbutan-2-yl) propylphosphonothioate

Synonyms:

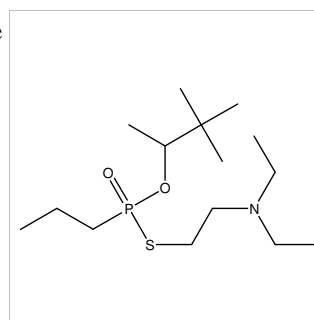

**Chemical name:** Cyclohexyl S-2-diethylaminoethyl propylphosphonothiolate

Schedule: 1A03

CAS RN: 468712-41-6

HS code: 2930.90

Key: 468712-41-6

Molecular formula: C<sub>15</sub>H<sub>32</sub>NO<sub>2</sub>PS

CAS Index Name: Phosphonothioic acid, propyl-, S-[2-(diethylamino)ethyl] O-cyclohexyl ester

**IUPAC name:** Cyclohexyl S-[2-(diethylamino)ethyl] propylphosphonothioate

Synonyms:

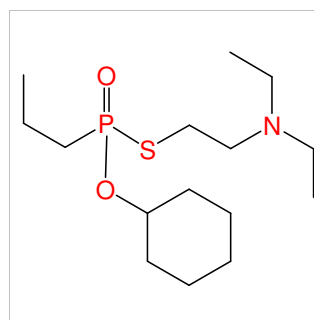

**Chemical name:** 4-Methylcyclohexyl S-2-diethylaminoethyl propylphosphonothiolate

Schedule: 1A03

CAS RN: 468712-44-9

HS code: 2930.90

Key: 468712-44-9

Molecular formula: C<sub>16</sub>H<sub>34</sub>NO<sub>2</sub>PS

CAS Index Name: Phosphonothioic acid, propyl-, S-[2-(diethylamino)ethyl] O-(4-methylcyclohexyl) ester

**IUPAC name:** S-[2-(diethylamino)ethyl] O-(4-methylcyclohexyl) propylphosphonothioate

Synonyms:

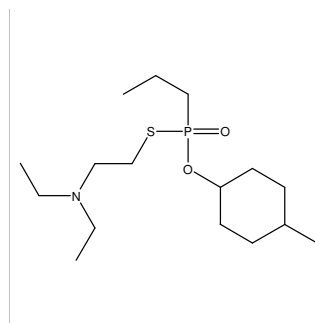

**Chemical name:** Nonyl S-2-diethylaminoethyl propylphosphonothiolate

Schedule: 1A03

CAS RN: 468712-45-0

HS code: 2930.90

Key: 468712-45-0

Molecular formula: C<sub>18</sub>H<sub>40</sub>NO<sub>2</sub>PS

CAS Index Name: Phosphonothioic acid, propyl-, S-[2-(diethylamino)ethyl] O-nonyl ester

**IUPAC name:** S-[2-(diethylamino)ethyl] O-nonyl propylphosphonothioate

Synonyms:

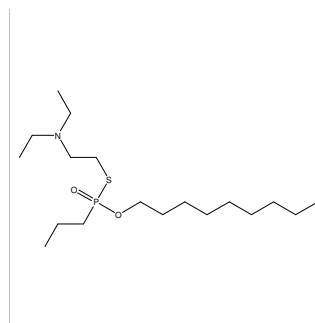

**Chemical name:** Butyl S-2-diethylaminoethyl isopropylphosphonothiolate

Schedule: 1A03

CAS RN: 468712-46-1

HS code: 2930.90

Key: 468712-46-1

Molecular formula: C<sub>13</sub>H<sub>30</sub>NO<sub>2</sub>PS

CAS Index Name: Phosphonothioic acid, 1-methylethyl-, S-[2-(diethylamino)ethyl] O-butyl ester

**IUPAC name:** Butyl S-2-diethylaminoethyl isopropylphosphonothioate

Synonyms: O-n-Butyl S-2-diethylaminoethyl isopropylphosphonothiolate

O-Butyl S-2-diethylaminoethyl isopropylphosphonothiolate

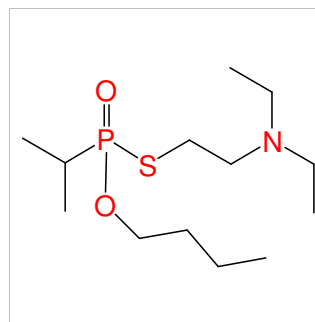

**Chemical name:** Isobutyl S-2-diethylaminoethyl  
isopropylphosphonothiolate

Schedule: 1A03

CAS RN: 468712-47-2

HS code: 2930.90

Key: 468712-47-2

Molecular formula: C<sub>13</sub>H<sub>30</sub>NO<sub>2</sub>PS

**CAS Index Name:** Phosphonothioic acid, 1-methylethyl-, S-[2-(diethylamino)ethyl] O-(2-methylpropyl) ester

**IUPAC name:** Isobutyl S-2-diethylaminoethyl  
isopropylphosphonothioate

**Synonyms:** Phosphonothioic acid, 1-methylethyl-, S-[2-(diethylamino)ethyl] O-2-methylpropyl ester  
O-Isobutyl S-2-diethylaminoethyl isopropylphosphonothiolate  
O-2-Methylpropyl S-2-diethylaminoethyl isopropylphosphonothiolate

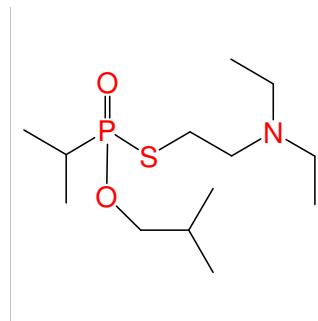

**Chemical name:** sec-Butyl S-2-diethylaminoethyl  
isopropylphosphonothiolate

Schedule: 1A03

CAS RN: 468712-48-3

HS code: 2930.90

Key: 468712-48-3

Molecular formula: C<sub>13</sub>H<sub>30</sub>NO<sub>2</sub>PS

**CAS Index Name:** Phosphonothioic acid, 1-methylethyl-, S-[2-(diethylamino)ethyl] O-(1-methylpropyl) ester

**IUPAC name:** sec-Butyl S-2-diethylaminoethyl  
isopropylphosphonothioate

**Synonyms:** Phosphonothioic acid, 1-methylethyl-, S-[2-(diethylamino)ethyl] O-1-methylpropyl ester  
O-sec-Butyl S-2-diethylaminoethyl isopropylphosphonothiolate  
O-1-Methylpropyl S-2-diethylaminoethyl isopropylphosphonothiolate  
Butan-2-yl S-2-diethylaminoethyl isopropylphosphonothiolate  
But-2-yl S-2-diethylaminoethyl isopropylphosphonothiolate  
1-Methylpropyl S-2-diethylaminoethyl isopropylphosphonothiolate

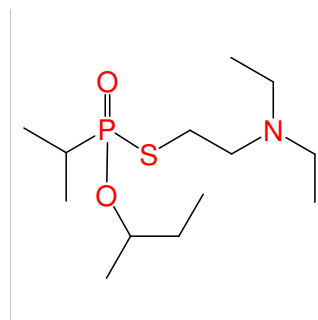

**Chemical name:** Pentyl S-2-diethylaminoethyl isopropylphosphonothiolate

Schedule: 1A03

CAS RN: 468712-49-4

HS code: 2930.90

Key: 468712-49-4

Molecular formula: C<sub>14</sub>H<sub>32</sub>NO<sub>2</sub>PS

**CAS Index Name:** Phosphonothioic acid, (1-methylethyl)-, S-[2-(diethylamino)ethyl] O-pentyl ester

**IUPAC name:** S-[2-(diethylamino)ethyl] O-pentyl  
isopropylphosphonothioate

**Synonyms:**

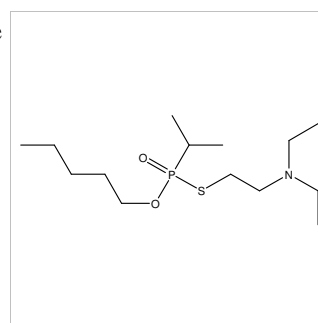

**Chemical name:** Cyclopentyl S-2-diethylaminoethyl isopropylphosphonothiolate

Schedule: 1A03

CAS RN: 468712-51-8

HS code: 2930.90

Key: 468712-51-8

Molecular formula: C<sub>14</sub>H<sub>30</sub>NO<sub>2</sub>PS

CAS Index Name: Phosphonothioic acid, (1-methylethyl)-, O-cyclopentyl S-[2-(diethylamino)ethyl] ester

**IUPAC name:** O-cyclopentyl S-[2-(diethylamino)ethyl] isopropylphosphonothioate

Synonyms:

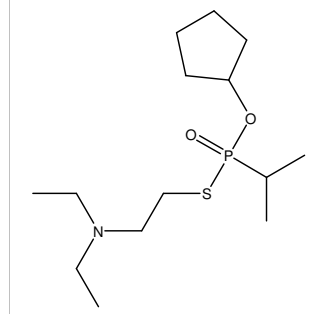

**Chemical name:** Hexyl S-2-diethylaminoethyl isopropylphosphonothiolate

Schedule: 1A03

CAS RN: 468712-53-0

HS code: 2930.90

Key: 468712-53-0

Molecular formula: C<sub>15</sub>H<sub>34</sub>NO<sub>2</sub>PS

CAS Index Name: Phosphonothioic acid, (1-methylethyl)-, S-[2-(diethylamino)ethyl] O-hexyl ester

**IUPAC name:** S-[2-(diethylamino)ethyl] O-hexyl isopropylphosphonothioate

Synonyms:

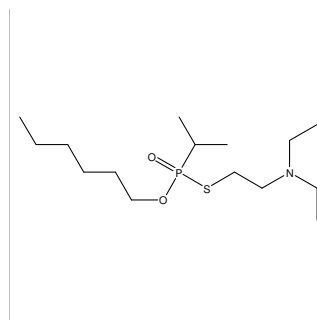

**Chemical name:** Cyclohexyl S-2-diethylaminoethyl isopropylphosphonothiolate

Schedule: 1A03

CAS RN: 468712-54-1

HS code: 2930.90

Key: 468712-54-1

Molecular formula: C<sub>15</sub>H<sub>32</sub>NO<sub>2</sub>PS

CAS Index Name: Phosphonothioic acid, (1-methylethyl)-, O-cyclohexyl S-[2-(diethylamino)ethyl] ester

**IUPAC name:** Cyclohexyl S-[2-(diethylamino)ethyl] isopropylphosphonothioate

Synonyms:

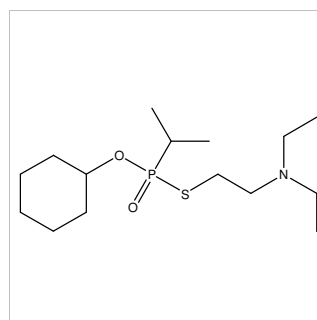

**Chemical name:** 4-Methylcyclohexyl S-2-diethylaminoethyl isopropylphosphonothiolate

Schedule: 1A03

CAS RN: 468712-57-4

HS code: 2930.90

Key: 468712-57-4

Molecular formula: C<sub>16</sub>H<sub>34</sub>NO<sub>2</sub>PS

CAS Index Name: Phosphonothioic acid, (1-methylethyl)-, S-[2-(diethylamino)ethyl] O-(4-methylcyclohexyl) ester

**IUPAC name:** S-[2-(diethylamino)ethyl] O-(4-methylcyclohexyl) isopropylphosphonothioate

Synonyms:

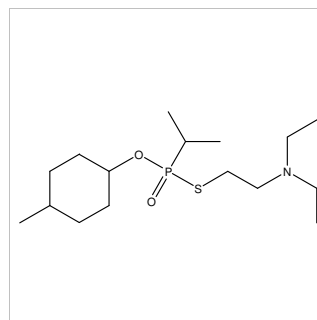

**Chemical name:** Heptyl S-2-diethylaminoethyl isopropylphosphonothiolate

Schedule: 1A03

CAS RN: 468712-58-5

HS code: 2930.90

Key: 468712-58-5

Molecular formula: C<sub>16</sub>H<sub>36</sub>NO<sub>2</sub>PS

CAS Index Name: Phosphonothioic acid, (1-methylethyl)-, S-[2-(diethylamino)ethyl] O-heptyl ester

**IUPAC name:** S-[2-(diethylamino)ethyl] O-heptyl isopropylphosphonothioate

Synonyms:

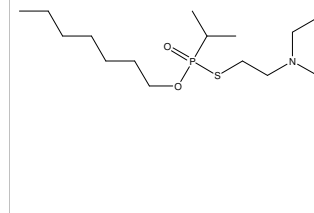

**Chemical name:** Octyl S-2-diethylaminoethyl isopropylphosphonothiolate

Schedule: 1A03

CAS RN: 468712-60-9

HS code: 2930.90

Key: 468712-60-9

Molecular formula: C<sub>17</sub>H<sub>38</sub>NO<sub>2</sub>PS

CAS Index Name: Phosphonothioic acid, (1-methylethyl)-, S-[2-(diethylamino)ethyl] O-octyl ester

**IUPAC name:** S-[2-(diethylamino)ethyl] O-octyl isopropylphosphonothioate

Synonyms:

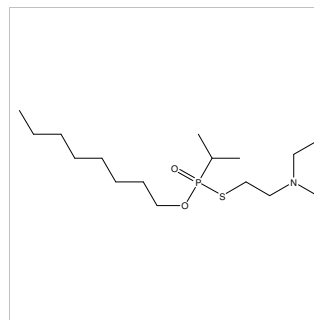

**Chemical name:** Nonyl S-2-diethylaminoethyl isopropylphosphonothiolate

Schedule: 1A03

CAS RN: 468712-61-0

HS code: 2930.90

Key: 468712-61-0

Molecular formula: C<sub>18</sub>H<sub>40</sub>NO<sub>2</sub>PS

CAS Index Name: Phosphonothioic acid, (1-methylethyl)-, S-[2-(diethylamino)ethyl] O-nonyl ester

**IUPAC name:** S-[2-(diethylamino)ethyl] O-nonyl isopropylphosphonothioate

Synonyms:

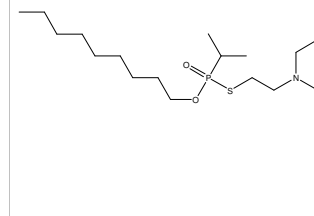

**Chemical name:** Ethyl S-2-diisopropylaminoethyl methylphosphonothiolate

**Schedule:** 1A03

**CAS RN:** 50782-69-9

**HS code:** 2930.90

**Key:** 50782-69-9

**Molecular formula:** C<sub>11</sub>H<sub>26</sub>NO<sub>2</sub>PS

**CAS Index Name:** Phosphonothioic acid, methyl-, S-[2-(bis(1-methylethyl)amino)ethyl] O-ethyl ester

**IUPAC name:** Ethyl S-2-diisopropylaminoethyl methylphosphonothioate

**Synonyms:** VX Vapor

VX

Tx 60

S-[2-(Diisopropylamino)ethyl] O-ethyl methylphosphonothiolate

S-[2-(Diisopropylamino)ethyl] O-ethyl methylphosphonothioate

O-Ethyl S-diisopropylaminoethyl methylphosphonothioate

O-Ethyl S-2-diisopropylaminoethyl methylphosphonothiolate

O-Ethyl S-(2-diisopropylaminoethyl) methylthiophosphonate

O-Ethyl S-(2-diisopropylaminoethyl) methylphosphonothioate

MPT

Ethyl S-2-diisopropylaminoethyl methylphosphonothiolate

A 4

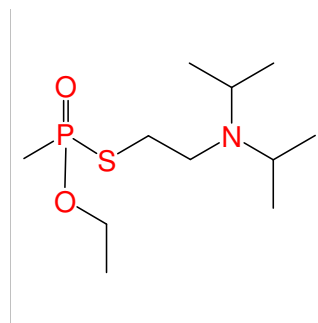

**Chemical name:** sec-Butyl S-2-dimethylaminoethyl ethylphosphonothiolate

**Schedule:** 1A03

**CAS RN:** 50929-96-9

**HS code:** 2930.90

**Key:** 50929-96-9

**Molecular formula:** C<sub>10</sub>H<sub>24</sub>NO<sub>2</sub>PS

**CAS Index Name:** Phosphonothioic acid, ethyl-, S-[2-(dimethylamino)ethyl] O-(1-methylpropyl) ester

**IUPAC name:** sec-Butyl S-2-dimethylaminoethyl ethylphosphonothioate

**Synonyms:** S-[2-(dimethylamino)ethyl] O-but-2-yl ethylphosphonothiolate

Phosphonothioic acid, ethyl-, S-[2-(dimethylamino)ethyl] O-1-methylpropyl ester

O-sec-Butyl S-2-dimethylaminoethyl ethylphosphonothiolate

Butan-2-yl S-2-dimethylaminoethyl ethylphosphonothiolate

But-2-yl S-2-dimethylaminoethyl ethylphosphonothiolate

1-Methylpropyl S-2-dimethylaminoethyl ethylphosphonothiolate

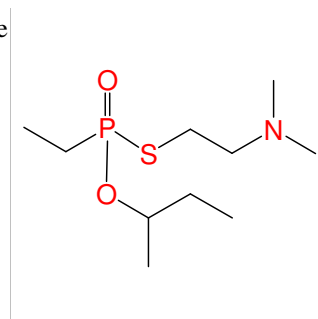

**Chemical name:** Isopropyl S-2-diisopropylaminoethyl methylphosphonothiolate

Schedule: 1A03

CAS RN: 51446-23-2

HS code: 2930.90

Key: 51446-23-2

Molecular formula: C<sub>12</sub>H<sub>28</sub>NO<sub>2</sub>PS

CAS Index Name: Phosphonothioic acid, methyl-, S-[2-(bis(1-methylethyl)amino)ethyl] O-(1-methylethyl) ester

**IUPAC name:** Isopropyl S-2-diisopropylaminoethyl methylphosphonothioate

Synonyms: S-[2-(Diisopropylamino)ethyl] O-isopropyl methylphosphonothioate

Phosphonothioic acid, methyl-, S-[2-(bis(1-methylethyl)amino)ethyl] O-1-methylethyl ester

O-Isopropyl S-2-diisopropylaminoethyl methylphosphonothiolate

O-Isopropyl S-[2-(diisopropylamino)ethyl] methylthiophosphonate

O-Isopropyl S-(2-diisopropylaminoethyl) methylphosphonothioate

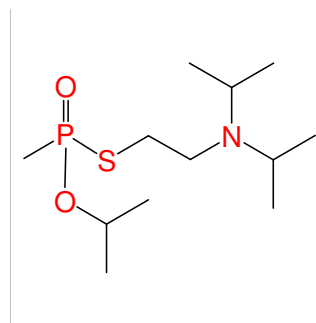

**Chemical name:** Propyl S-2-diisopropylaminoethyl methylphosphonothiolate

Schedule: 1A03

CAS RN: 52364-45-1

HS code: 2930.90

Key: 52364-45-1

Molecular formula: C<sub>12</sub>H<sub>28</sub>NO<sub>2</sub>PS

CAS Index Name: Phosphonothioic acid, methyl-, S-[2-(bis(1-methylethyl)amino)ethyl] O-propyl ester

**IUPAC name:** Propyl S-2-diisopropylaminoethyl methylphosphonothioate

Synonyms: O-Propyl S-2-diisopropylaminoethyl methylphosphonothiolate

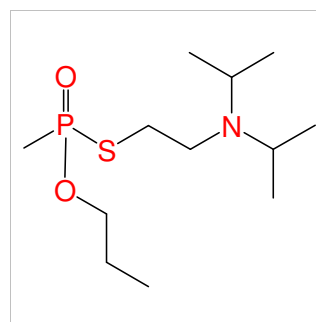

**Chemical name:** Butyl S-2-diisopropylaminoethyl methylphosphonothiolate

Schedule: 1A03

CAS RN: 52364-46-2

HS code: 2930.90

Key: 52364-46-2

Molecular formula: C<sub>13</sub>H<sub>30</sub>NO<sub>2</sub>PS

CAS Index Name: Phosphonothioic acid, methyl-, S-[2-(bis(1-methylethyl)amino)ethyl] O-butyl ester

**IUPAC name:** Butyl S-2-diisopropylaminoethyl methylphosphonothioate

Synonyms: S-[2-(diisopropylamino)ethyl] O-Butyl methylphosphonothioate

O-Butyl S-2-diisopropylaminoethyl methylphosphonothiolate

O-Butyl S-[2-(diisopropylamino)ethyl] methylphosphonothioate

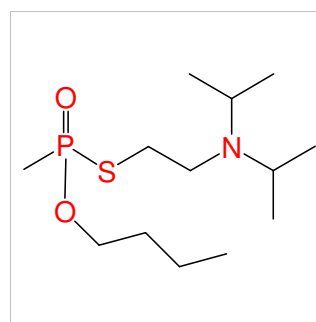

**Chemical name:** Propyl S-2-dimethylaminoethyl methylphosphonothiolate

Schedule: 1A03

CAS RN: 56217-62-0

HS code: 2930.90

Key: 56217-62-0

Molecular formula: C<sub>8</sub>H<sub>20</sub>NO<sub>2</sub>PS

CAS Index Name: Phosphonothioic acid, methyl-, S-[2-(dimethylamino)ethyl] O-propyl ester

**IUPAC name:** Propyl S-2-dimethylaminoethyl methylphosphonothioate

Synonyms: O-Propyl S-2-dimethylaminoethyl methylphosphonothiolate

O-Propyl S-2-(dimethylamino)ethyl methylphosphonothiolate

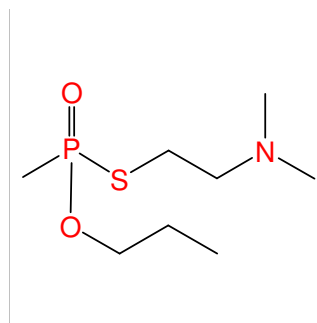

**Chemical name:** Butyl S-2-dimethylaminoethyl methylphosphonothiolate

Schedule: 1A03

CAS RN: 56217-63-1

HS code: 2930.90

Key: 56217-63-1

Molecular formula: C<sub>9</sub>H<sub>22</sub>NO<sub>2</sub>PS

CAS Index Name: Phosphonothioic acid, methyl-, S-[2-(dimethylamino)ethyl] O-butyl ester

**IUPAC name:** Butyl S-2-dimethylaminoethyl methylphosphonothioate

Synonyms: O-Butyl S-2-dimethylaminoethyl methylphosphonothiolate

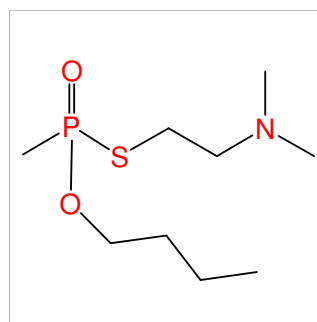

**Chemical name:** Pentyl S-2-dimethylaminoethyl methylphosphonothiolate

Schedule: 1A03

CAS RN: 56217-64-2

HS code: 2930.90

Key: 56217-64-2

Molecular formula: C<sub>10</sub>H<sub>24</sub>NO<sub>2</sub>PS

CAS Index Name: Phosphonothioic acid, methyl-, S-[2-(dimethylamino)ethyl] O-pentyl ester

**IUPAC name:** Pentyl S-2-dimethylaminoethyl methylphosphonothioate

Synonyms: O-Pentyl S-2-dimethylaminoethyl methylphosphonothiolate

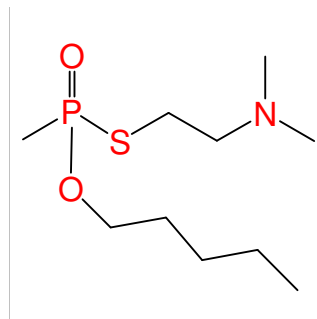



**Chemical name:** Isobutyl S-2-dimethylaminoethyl methylphosphonothiolate

Schedule: 1A03

CAS RN: 56217-65-3

HS code: 2930.90

Key: 56217-65-3

Molecular formula: C<sub>9</sub>H<sub>22</sub>NO<sub>2</sub>PS

CAS Index Name: Phosphonothioic acid, methyl-, S-[2-(dimethylamino)ethyl] O-(2-methylpropyl) ester

**IUPAC name:** Isobutyl S-2-dimethylaminoethyl methylphosphonothioate

Synonyms: Phosphonothioic acid, methyl-, S-[2-(dimethylamino)ethyl] O-2-methylpropyl ester  
O-Isobutyl S-2-dimethylaminoethyl methylphosphonothiolate

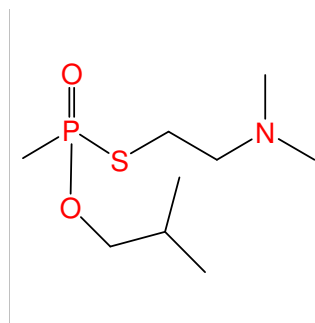

**Chemical name:** 2,2-Dimethylpropyl S-2-dimethylaminoethyl methylphosphonothiolate

Schedule: 1A03

CAS RN: 56217-66-4

HS code: 2930.90

Key: 56217-66-4

Molecular formula: C<sub>10</sub>H<sub>24</sub>NO<sub>2</sub>PS

CAS Index Name: Phosphonothioic acid, methyl-, S-[2-(dimethylamino)ethyl] O-(2,2-dimethylpropyl) ester

**IUPAC name:** 2,2-Dimethylpropyl S-2-dimethylaminoethyl methylphosphonothioate

Synonyms: O-2,2-Dimethylpropyl S-2-dimethylaminoethyl methylphosphonothiolate  
Neopentyl S-2-dimethylaminoethyl methylphosphonothiolate

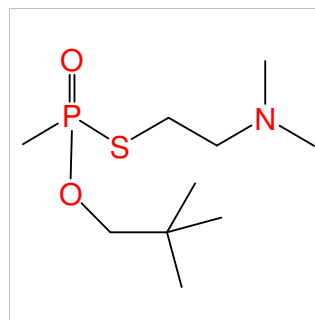

**Chemical name:** Ethyl S-2-trimethylammoniumethyl methylphosphonothiolate

Schedule: 1A03

CAS RN: 56217-67-5

HS code: 2930.90

Key: 56217-67-5

Molecular formula: C<sub>8</sub>H<sub>21</sub>NO<sub>2</sub>PS

CAS Index Name: Ethanaminium, 2-[(ethoxymethylphosphinyl)thio]-N,N,N-trimethyl-

**IUPAC name:** 2-{[Ethoxy(methyl)phosphoryl]thio}-N,N,N-trimethylethanaminium

Synonyms: O-Ethyl S-2-trimethylammoniumethyl methylphosphonothiolate  
2-{[Ethoxy(methyl)phosphoryl]sulfanyl}-N,N,N-trimethylethanaminium

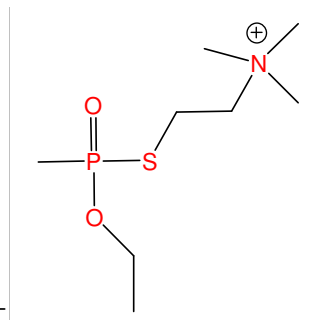

**Chemical name:** Propyl S-2-trimethylammoniummethyl methylphosphonothiolate

Schedule: 1A03

CAS RN: 56217-68-6

HS code: 2930.90

Key: 56217-68-6

Molecular formula: C<sub>9</sub>H<sub>23</sub>NO<sub>2</sub>PS<sup>+</sup>

CAS Index Name: Ethanaminium, N,N,N-trimethyl-2-  
{[methyl(propoxy)phosphinyl]thio}-

**IUPAC name:** N,N,N-Trimethyl-2-  
{[methyl(propoxy)phosphoryl]thio}ethanaminium

Synonyms: O-Propyl S-2-trimethylammoniummethyl methylphosphonothiolate

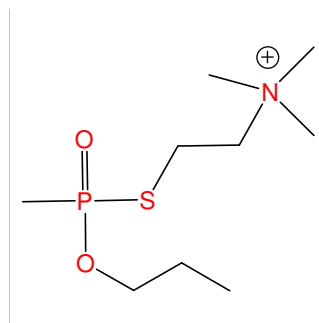

**Chemical name:** Isopropyl S-2-trimethylammoniummethyl methylphosphonothiolate

Schedule: 1A03

CAS RN: 56217-69-7

HS code: 2930.90

Key: 56217-69-7

Molecular formula: C<sub>9</sub>H<sub>23</sub>NO<sub>2</sub>PS<sup>+</sup>

CAS Index Name: Ethanaminium, N,N,N-trimethyl-2-[[methyl(1  
methylethoxy)phosphinyl]thio]-

**IUPAC name:** 2-[[Isopropoxy(methyl)phosphoryl]thio]-N,N,N-  
trimethylethanaminium

Synonyms: O-Isopropyl S-2-trimethylammoniummethyl methylphosphonothiolate

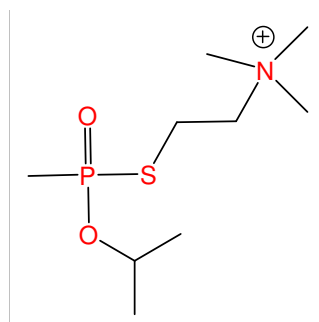

**Chemical name:** Ethyl S-2-dipropylaminoethyl methylphosphonothiolate

Schedule: 1A03

CAS RN: 62512-68-9

HS code: 2930.90

Key: 62512-68-9

Molecular formula: C<sub>11</sub>H<sub>26</sub>NO<sub>2</sub>PS

CAS Index Name: Phosphonothioic acid, methyl-, S-[2-  
(dipropylamino)ethyl] O-ethyl ester

**IUPAC name:** Ethyl S-2-dipropylaminoethyl methylphosphonothioate

Synonyms: O-Ethyl S-2-dipropylaminoethyl methylphosphonothiolate

O-Ethyl S-2-(dipropylamino)ethyl methylphosphonothiolate

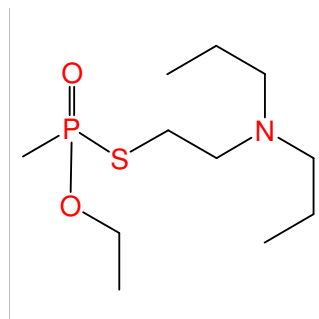

**Chemical name:** (R)-Ethyl S-2-diisopropylaminoethyl methylphosphonothiolate

Schedule: 1A03

CAS RN: 65167-63-7

HS code: 2930.90

Key: 65167-63-7

Molecular formula: C<sub>11</sub>H<sub>26</sub>NO<sub>2</sub>PS

CAS Index Name: Phosphonothioic acid, methyl-, S-[2-(bis(1-methylethyl)amino)ethyl] O-ethyl ester, (R)-

**IUPAC name:** (R)-O-Ethyl S-[2-(diisopropylamino)ethyl] methylphosphonothioate

Synonyms: (R)-VX

(R)-O-Ethyl S-2-diisopropylaminoethyl methylphosphonothiolate

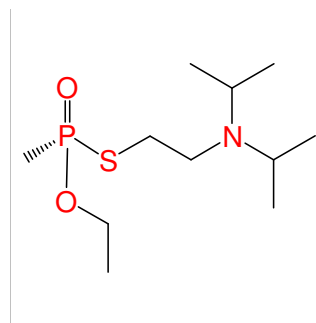

**Chemical name:** (S)-Ethyl S-2-diisopropylaminoethyl methylphosphonothiolate

Schedule: 1A03

CAS RN: 65167-64-8

HS code: 2930.90

Key: 65167-64-8

Molecular formula: C<sub>11</sub>H<sub>26</sub>NO<sub>2</sub>PS

CAS Index Name: Phosphonothioic acid, methyl-, S-[2-[bis(1-methylethyl)amino]ethyl] O-ethyl ester, (S)-

**IUPAC name:** (S)-O-Ethyl S-[2-(diisopropylamino)ethyl] methylphosphonothioate

Synonyms: (S)-VX

(S)-O-Ethyl S-2-diisopropylaminoethyl methylphosphonothiolate

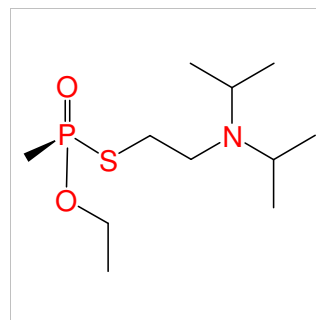

**Chemical name:** Hexyl S-2-dimethylaminoethyl methylphosphonothiolate

Schedule: 1A03

CAS RN: 69777-00-0

HS code: 2930.90

Key: 69777-00-0

Molecular formula: C<sub>11</sub>H<sub>26</sub>NO<sub>2</sub>PS

CAS Index Name: Phosphonothioic acid, methyl-, S-[2-(dimethylamino)ethyl] O-hexyl ester

**IUPAC name:** Hexyl S-2-dimethylaminoethyl methylphosphonothioate

Synonyms: O-Hexyl S-2-dimethylaminoethyl methylphosphonothiolate

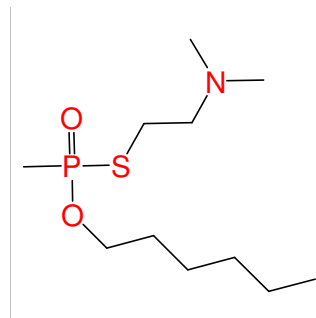

**Chemical name:** Cyclohexyl S-2-dimethylaminoethyl methylphosphonothiolate

Schedule: 1A03

CAS RN: 69795-06-8

HS code: 2930.90

Key: 69795-06-8

Molecular formula: C<sub>11</sub>H<sub>24</sub>NO<sub>2</sub>PS

CAS Index Name: Phosphonothioic acid, methyl-, S-[2-(dimethylamino)ethyl] O-cyclohexyl ester

**IUPAC name:** Cyclohexyl S-2-dimethylaminoethyl methylphosphonothioate

Synonyms: O-Cyclohexyl S-2-dimethylaminoethyl methylphosphonothiolate

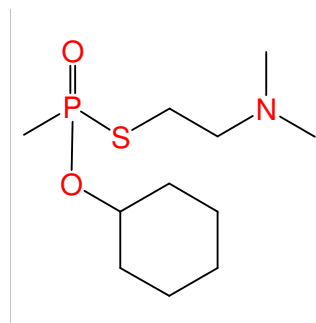

**Chemical name:** Cyclohexyl S-2-diethylaminoethyl methylphosphonothiolate

Schedule: 1A03

CAS RN: 71293-89-5

HS code: 2930.90

Key: 71293-89-5

Molecular formula: C<sub>13</sub>H<sub>28</sub>NO<sub>2</sub>PS

CAS Index Name: Phosphonothioic acid, methyl-, S-[2-(diethylamino)ethyl] O-cyclohexyl ester

**IUPAC name:** Cyclohexyl S-2-diethylaminoethyl methylphosphonothioate

Synonyms: O-Cyclohexyl S-2-diethylaminoethyl methylphosphonothiolate

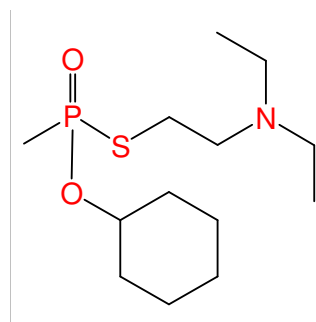

**Chemical name:** S-2-Diisopropylaminoethyl methylphosphonothiolate

Schedule: 1A03

CAS RN: 73207-98-4

HS code: 2930.90

Key: 73207-98-4

Molecular formula: C<sub>9</sub>H<sub>22</sub>NO<sub>2</sub>PS

CAS Index Name: Phosphonothioic acid, methyl-, S-[2-(bis(1-methylethyl)amino)ethyl] ester

**IUPAC name:** S-2-Diisopropylaminoethyl methylphosphonothioate

Synonyms: S-2-Diisopropylaminoethyl methylphosphonothiolate

S-2-Diisopropylaminoethyl hydrogen methylphosphonothiolate

O-Hydrogen S-2-diisopropylaminoethyl methylphosphonothiolate

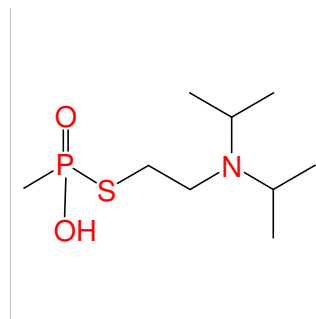

**Chemical name:** Ethyl S-2-diisopropylaminoethyl ethylphosphonothiolate

Schedule: 1A03

CAS RN: 73835-17-3

HS code: 2930.90

Key: 73835-17-3

Molecular formula: C<sub>12</sub>H<sub>28</sub>NO<sub>2</sub>PS

CAS Index Name: Phosphonothioic acid, ethyl-, S-[2-(bis(1-methylethyl)amino)ethyl] O-ethyl ester

**IUPAC name:** Ethyl S-2-diisopropylaminoethyl ethylphosphonothioate

Synonyms: VS (phosphonothioate)

VS

O-Ethyl S-2-diisopropylaminoethyl ethylphosphonothiolate

O-Ethyl S-2-(diisopropylamino)ethyl ethylphosphonothiolate

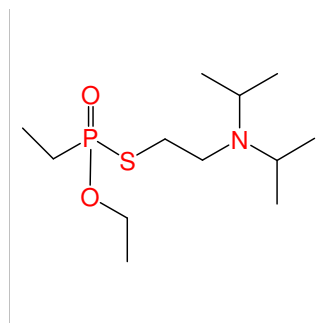

**Chemical name:** 1-Methylpentyl S-2-dimethylaminoethyl methylphosphonothiolate

Schedule: 1A03

CAS RN: 79351-19-2

HS code: 2930.90

Key: 79351-19-2

Molecular formula: C<sub>11</sub>H<sub>26</sub>NO<sub>2</sub>PS

CAS Index Name: Phosphonothioic acid, methyl-, S-[2-(dimethylamino)ethyl] O-(1-methylpentyl) ester

**IUPAC name:** 1-Methylpentyl S-2-dimethylaminoethyl methylphosphonothioate

Synonyms: O-1-Methylpentyl S-2-dimethylaminoethyl methylphosphonothiolate

Hexan-2-yl S-2-dimethylaminoethyl methylphosphonothiolate

Hex-2-yl S-2-dimethylaminoethyl methylphosphonothiolate

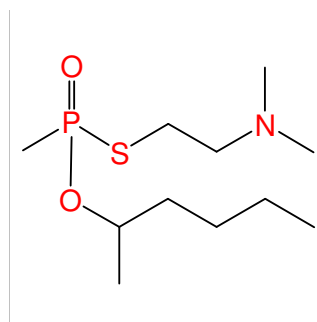

**Chemical name:** Hexyl S-2-diisopropylaminoethyl methylphosphonothiolate

Schedule: 1A03

CAS RN: 82721-31-1

HS code: 2930.90

Key: 82721-31-1

Molecular formula: C<sub>15</sub>H<sub>34</sub>NO<sub>2</sub>PS

CAS Index Name: Phosphonothioic acid, methyl-, S-[2-(bis(1-methylethyl)amino)ethyl] O-hexyl ester

**IUPAC name:** Hexyl S-2-diisopropylaminoethyl methylphosphonothioate

Synonyms: O-Hexyl S-2-diisopropylaminoethyl methylphosphonothiolate

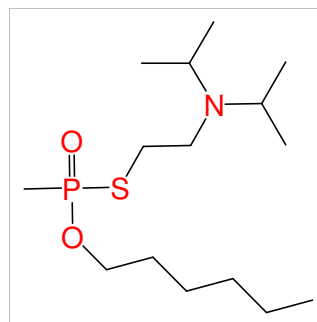

**Chemical name:** Cyclopentyl S-2-diisopropylaminoethyl methylphosphonothiolate

Schedule: 1A03

CAS RN: 85473-33-2

HS code: 2930.90

Key: 85473-33-2

Molecular formula: C<sub>14</sub>H<sub>30</sub>NO<sub>2</sub>PS

CAS Index Name: Phosphonothioic acid, methyl-, S-[2-(bis(1-methylethyl)amino)ethyl] O-cyclopentyl ester

**IUPAC name:** Cyclopentyl S-2-diisopropylaminoethyl methylphosphonothioate

Synonyms: O-Cyclopentyl S-2-diisopropylaminoethyl methylphosphonothiolate

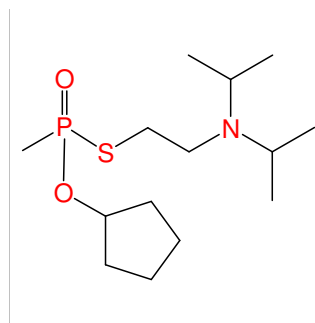

**Chemical name:** Isobutyl S-2-diisopropylaminoethyl methylphosphonothiolate

Schedule: 1A03

CAS RN: 855307-83-4

HS code: 2930.90

Key: 855307-83-4

Molecular formula: C<sub>13</sub>H<sub>30</sub>NO<sub>2</sub>PS

CAS Index Name: Phosphonothioic acid, methyl-, S-[2-(bis(1-methylethyl)amino)ethyl] O-(2-methylpropyl) ester

**IUPAC name:** Isobutyl S-2-diisopropylaminoethyl methylphosphonothioate

Synonyms: Phosphonothioic acid, methyl-, S-[2-(bis(1-methylethyl)amino)ethyl] O-2-methylpropyl

O-Isobutyl S-2-diisopropylaminoethyl methylphosphonothiolate

O-2-Methylpropyl S-2-diisopropylaminoethyl methylphosphonothiolate

2-Methylpropyl S-2-diisopropylaminoethyl methylphosphonothiolate

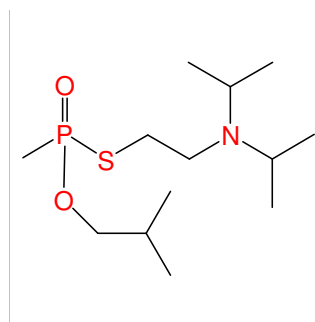

**Chemical name:** Isopropyl S-2-diethylaminoethyl methylphosphonothiolate

Schedule: 1A03

CAS RN: 91134-95-1

HS code: 2930.90

Key: 91134-95-1

Molecular formula: C<sub>10</sub>H<sub>24</sub>NO<sub>2</sub>PS

CAS Index Name: Phosphonothioic acid, methyl-, S-[2-(diethylamino)ethyl] O-(1-methylethyl) ester

**IUPAC name:** Isopropyl S-2-diethylaminoethyl methylphosphonothioate

Synonyms: Phosphonothioic acid, methyl-, S-[2-(diethylamino)ethyl] O-1-methylethyl ester

O-Isopropyl S-2-diethylaminoethyl methylphosphonothiolate

O-Isopropyl S-2-(diethylamino)ethyl methylphosphonothiolate

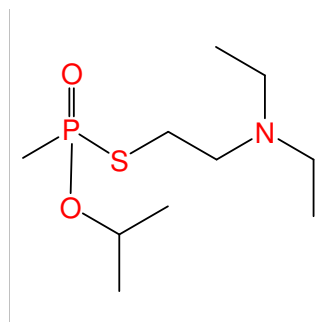

**Chemical name:** Cyclopentyl S-2-diethylaminoethyl methylphosphonothiolate

Schedule: 1A03

CAS RN: 93240-66-5

HS code: 2930.90

Key: 93240-66-5

Molecular formula: C<sub>12</sub>H<sub>26</sub>NO<sub>2</sub>PS

CAS Index Name: Phosphonothioic acid, methyl-, S-[2-(diethylamino)ethyl] O-cyclopentyl ester

**IUPAC name:** Cyclopentyl S-2-diethylaminoethyl methylphosphonothioate

Synonyms: O-Cyclopentyl S-2-diethylaminoethyl methylphosphonothiolate

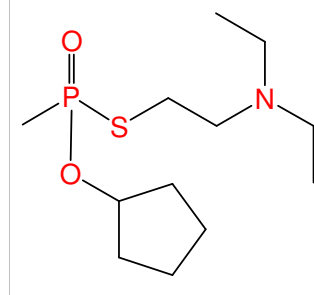

**Chemical name:** Butyl S-2-diisopropylaminoethyl isopropylphosphonothiolate

Schedule: 1A03

CAS RN: 958995-46-5

HS code: 2930.90

Key: 958995-46-5

Molecular formula: C<sub>15</sub>H<sub>34</sub>NO<sub>2</sub>PS

CAS Index Name: Phosphonothioic acid, 1-methylethyl-, S-[2-(bis(1-methylethyl)amino)ethyl] O-butyl ester

**IUPAC name:** Butyl S-2-diisopropylaminoethyl isopropylphosphonothioate

Synonyms: O-Butyl S-2-diisopropylaminoethyl isopropylphosphonothiolate

Butyl S-2-(diisopropylamino)ethyl isopropylphosphonothiolate

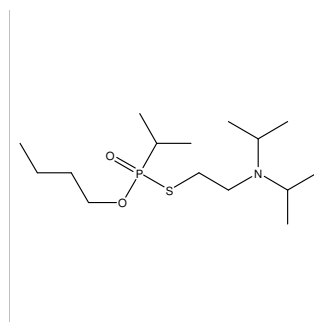

**Chemical name:** Propyl S-2-diisopropylaminoethyl propylphosphonothiolate

Schedule: 1A03

CAS RN: 958997-62-1

HS code: 2930.90

Key: 958997-62-1

Molecular formula: C<sub>14</sub>H<sub>32</sub>NO<sub>2</sub>PS

CAS Index Name: Phosphonothioic acid, propyl-, S-[2-(bis(1-methylethyl)amino)ethyl] O-propyl ester

**IUPAC name:** Propyl S-2-diisopropylaminoethyl propylphosphonothioate

Synonyms: Propyl S-2-(diisopropylamino)ethyl propylphosphonothiolate

O-Propyl S-2-diisopropylaminoethyl propylphosphonothiolate

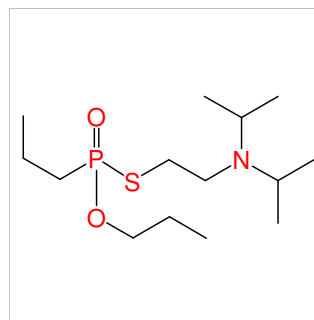

**Chemical name:** 1-Ethylpropyl S-2-diisopropylaminoethyl propylphosphonothiolate

Schedule: 1A03

CAS RN: 958997-65-4

HS code: 2930.90

Key: 958997-65-4

Molecular formula: C<sub>16</sub>H<sub>36</sub>NO<sub>2</sub>PS

CAS Index Name: Phosphonothioic acid, propyl-, S-[2-(bis(1-methylethyl)amino)ethyl] O-(1-ethylpropyl) ester

**IUPAC name:** 1-Ethylpropyl S-2-diisopropylaminoethyl propylphosphonothioate

Synonyms: S-[2-(Diisopropylamino)ethyl] O-pent-3-yl propylphosphonothiolate

Phosphonothioic acid, propyl-, S-[2-(bis(1-methylethyl)amino)ethyl] O-(1-ethylpropyl)

Pentan-3-yl S-2-diisopropylaminoethyl propylphosphonothiolate

Pent-3-yl S-2-diisopropylaminoethyl propylphosphonothiolate

O-1-Ethylpropyl S-2-diisopropylaminoethyl propylphosphonothiolate

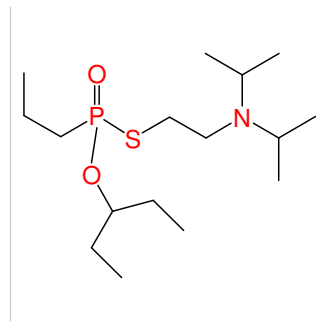

**Chemical name:** Octyl S-2-dimethylaminoethyl propylphosphonothiolate

Schedule: 1A03

CAS RN: 959010-49-2

HS code: 2930.90

Key: 959010-49-2

Molecular formula: C<sub>15</sub>H<sub>34</sub>NO<sub>2</sub>PS

CAS Index Name: Phosphonothioic acid, propyl-, S-[2-(dimethylamino)ethyl] O-octyl ester

**IUPAC name:** Octyl S-2-dimethylaminoethyl propylphosphonothioate

Synonyms: Octyl S-2-(dimethylamino)ethyl propylphosphonothiolate

O-Octyl S-2-dimethylaminoethyl propylphosphonothiolate

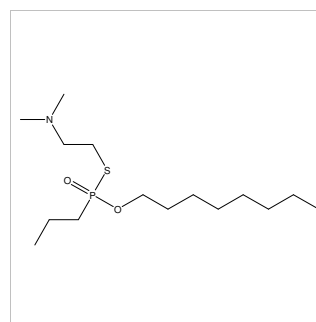

**Chemical name:** Cyclooctyl S-2-dimethylaminoethyl propylphosphonothiolate

Schedule: 1A03

CAS RN: 959010-50-5

HS code: 2930.90

Key: 959010-50-5

Molecular formula: C<sub>15</sub>H<sub>32</sub>NO<sub>2</sub>PS

CAS Index Name: Phosphonothioic acid, propyl-, S-[2-(dimethylamino)ethyl] O-cyclooctyl ester

**IUPAC name:** Cyclooctyl S-2-dimethylaminoethyl propylphosphonothioate

Synonyms: O-Cyclooctyl S-2-dimethylaminoethyl propylphosphonothiolate

Cyclooctyl S-2-(dimethylamino)ethyl propylphosphonothiolate

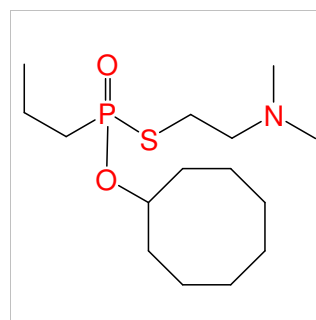



**Chemical name:** Cyclohexyl S-2-diethylaminoethyl ethylphosphonothiolate

Schedule: 1A03

CAS RN: 959020-04-3

HS code: 2930.90

Key: 959020-04-3

Molecular formula: C<sub>14</sub>H<sub>30</sub>NO<sub>2</sub>PS

CAS Index Name: Phosphonothioic acid, ethyl-, S-[2-(diethylamino)ethyl] O-cyclohexyl ester

**IUPAC name:** Cyclohexyl S-2-diethylaminoethyl ethylphosphonothioate

Synonyms: O-Cyclohexyl S-[2-(diethylamino)ethyl] ethylphosphonothiolate

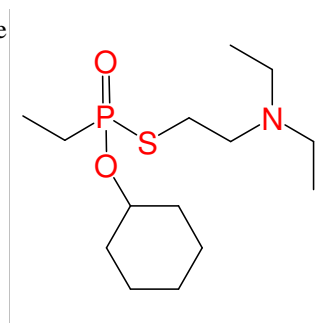

**Chemical name:** sec-Butyl S-2-diisopropylaminoethyl isopropylphosphonothiolate

Schedule: 1A03

CAS RN: 959040-29-0

HS code: 2930.90

Key: 959040-29-0

Molecular formula: C<sub>15</sub>H<sub>34</sub>NO<sub>2</sub>PS

CAS Index Name: Phosphonothioic acid, 1-methylethyl-, S-[2-(bis(1-methylethyl)amino)ethyl] O-(1-methylpropyl) ester

**IUPAC name:** sec-Butyl S-2-diisopropylaminoethyl isopropylphosphonothioate

Synonyms: sec-Butyl S-2-(diisopropylamino)ethyl isopropylphosphonothiolate

Phosphonothioic acid, 1-methylethyl-, S-[2-(bis(1-methylethyl)amino)ethyl] O-1-methyl ester

O-sec-Butyl S-2-diisopropylaminoethyl isopropylphosphonothiolate

O-1-Methylpropyl S-2-diisopropylaminoethyl isopropylphosphonothiolate

Butan-2-yl S-2-diisopropylaminoethyl isopropylphosphonothiolate

But-2-yl S-2-diisopropylaminoethyl isopropylphosphonothiolate

1-Methylpropyl S-2-diisopropylaminoethyl isopropylphosphonothiolate

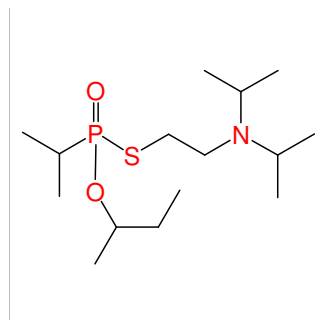

**Chemical name:** 4-Methylpentyl S-2-diisopropylaminoethyl propylphosphonothiolate

Schedule: 1A03

CAS RN: 959054-90-1

HS code: 2930.90

Key: 959054-90-1

Molecular formula: C<sub>17</sub>H<sub>38</sub>NO<sub>2</sub>PS

CAS Index Name: Phosphonothioic acid, propyl-, S-[2-(bis(1-methylethyl)amino)ethyl] O-(4-methylpentyl) ester

**IUPAC name:** 4-Methylpentyl S-2-diisopropylaminoethyl propylphosphonothioate

Synonyms: O-4-Methylpentyl S-2-diisopropylaminoethyl propylphosphonothiolate

4-Methylpentyl S-2-(diisopropylamino)ethyl propylphosphonothiolate

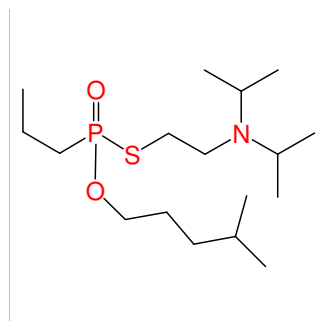

**Chemical name:** Cyclohexylmethyl S-2-dimethylaminoethyl propylphosphonothiolate

Schedule: 1A03

CAS RN: 959104-17-7

HS code: 2930.90

Key: 959104-17-7

Molecular formula: C<sub>14</sub>H<sub>30</sub>NO<sub>2</sub>PS

CAS Index Name: Phosphonothioic acid, propyl-, S-[2-(dimethylamino)ethyl] O-cyclohexylmethyl ester

**IUPAC name:** Cyclohexylmethyl S-2-dimethylaminoethyl propylphosphonothioate

Synonyms: O-Cyclohexylmethyl S-2-dimethylaminoethyl propylphosphonothiolate  
Cyclohexylmethyl S-2-(dimethylamino)ethyl propylphosphonothiolate

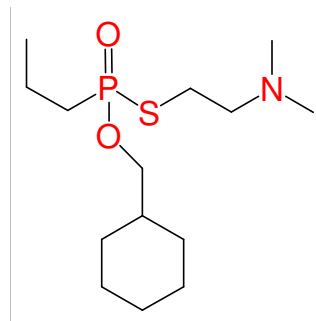

**Chemical name:** Butyl S-2-diisopropylaminoethyl propylphosphonothiolate

Schedule: 1A03

CAS RN: 959111-24-1

HS code: 2930.90

Key: 959111-24-1

Molecular formula: C<sub>15</sub>H<sub>34</sub>NO<sub>2</sub>PS

CAS Index Name: Phosphonothioic acid, propyl-, S-[2-(bis(1-methylethyl)amino)ethyl] O-butyl ester

**IUPAC name:** Butyl S-2-diisopropylaminoethyl propylphosphonothioate

Synonyms: O-Butyl S-2-diisopropylaminoethyl propylphosphonothiolate  
Butyl S-2-(diisopropylamino)ethyl propylphosphonothiolate

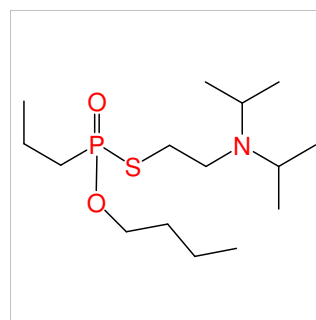

**Chemical name:** Heptyl S-2-diisopropylaminoethyl isopropylphosphonothiolate

Schedule: 1A03

CAS RN: 959233-58-0

HS code: 2930.90

Key: 959233-58-0

Molecular formula: C<sub>18</sub>H<sub>40</sub>NO<sub>2</sub>PS

CAS Index Name: Phosphonothioic acid, 1-methylethyl-, S-[2-(bis(1-methylethyl)amino)ethyl] O-heptyl ester

**IUPAC name:** Heptyl S-2-diisopropylaminoethyl isopropylphosphonothioate

Synonyms: O-Heptyl S-2-diisopropylaminoethyl isopropylphosphonothiolate  
O-Heptyl S-2-(diisopropylamino)ethyl isopropylphosphonothiolate  
Heptyl S-2-(diisopropylamino)ethyl isopropylphosphonothiolate

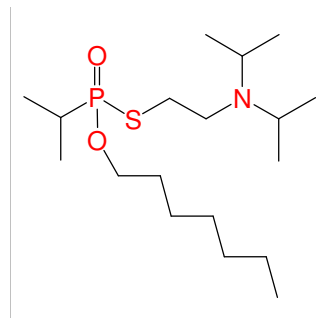

**Chemical name:** Cyclohexylmethyl S-2-diisopropylaminoethyl isopropylphosphonothiolate

Schedule: 1A03

CAS RN: 959233-60-4

HS code: 2930.90

Key: 959233-60-4

Molecular formula: C<sub>18</sub>H<sub>38</sub>NO<sub>2</sub>PS

CAS Index Name: Phosphonothioic acid, 1-methylethyl-, S-[2-(bis(1-methylethyl)amino)ethyl] O-cyclohexylmethyl ester

**IUPAC name:** Cyclohexylmethyl S-2-diisopropylaminoethyl isopropylphosphonothioate

Synonyms: O-Cyclohexylmethyl S-2-diisopropylaminoethyl isopropylphosphonothiolate

O-Cyclohexylmethyl S-2-(diisopropylamino)ethyl isopropylphosphonothiolate

Cyclohexylmethyl S-2-(diisopropylamino)ethyl isopropylphosphonothiolate

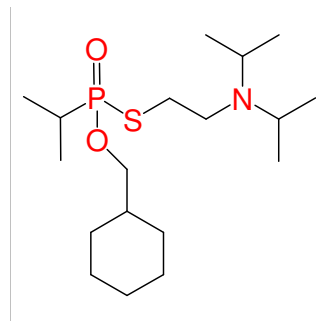

**Chemical name:** Propyl S-2-dipropylaminoethyl propylphosphonothiolate

Schedule: 1A03

CAS RN: 959233-79-5

HS code: 2930.90

Key: 959233-79-5

Molecular formula: C<sub>14</sub>H<sub>32</sub>NO<sub>2</sub>PS

CAS Index Name: Phosphonothioic acid, propyl-, S-[2-(dipropylamino)ethyl] O-propyl ester

**IUPAC name:** Propyl S-2-dipropylaminoethyl propylphosphonothioate

Synonyms: Propyl S-2-(dipropylamino)ethyl propylphosphonothiolate

O-Propyl S-2-dipropylaminoethyl propylphosphonothiolate

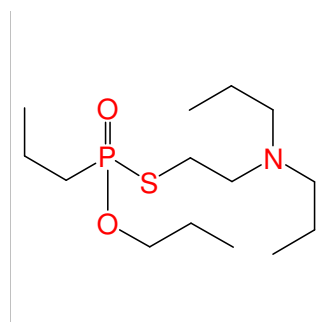

**Chemical name:** 3,5,5-Trimethylhexyl S-2-dimethylaminoethyl propylphosphonothiolate

Schedule: 1A03

CAS RN: 959250-22-7

HS code: 2930.90

Key: 959250-22-7

Molecular formula: C<sub>16</sub>H<sub>36</sub>NO<sub>2</sub>PS

CAS Index Name: Phosphonothioic acid, propyl-, S-[2-(dimethylamino)ethyl] O-(3,5,5-trimethylhexyl) ester

**IUPAC name:** 3,5,5-Trimethylhexyl S-2-dimethylaminoethyl propylphosphonothioate

Synonyms: O-3,5,5-Trimethylhexyl S-2-dimethylaminoethyl propylphosphonothiolate

O-3,5,5-Trimethylhexyl S-2-(dimethylamino)ethyl propylphosphonothiolate

3,5,5-Trimethylhexyl S-2-(dimethylamino)ethyl propylphosphonothiolate

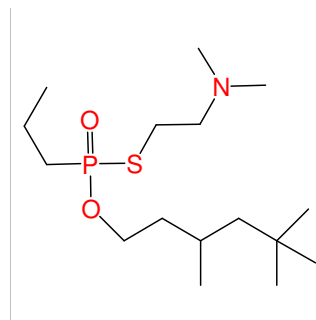

**Chemical name:** sec-Butyl S-2-diisopropylaminoethyl propylphosphonothiolate

Schedule: 1A03

CAS RN: 959257-17-1

HS code: 2930.90

Key: 959257-17-1

Molecular formula: C<sub>15</sub>H<sub>34</sub>NO<sub>2</sub>PS

CAS Index Name: Phosphonothioic acid, propyl-, S-[2-(bis(1-methylethyl)amino)ethyl] O-(1-methylpropyl) ester

**IUPAC name:** sec-Butyl S-2-diisopropylaminoethyl propylphosphonothioate

Synonyms: sec-Butyl S-2-(diisopropylamino)ethyl propylphosphonothiolate

Phosphonothioic acid, propyl-, S-[2-(bis(1-methylethyl)amino)ethyl] O-1-methylpropyl

O-sec-Butyl S-2-diisopropylaminoethyl propylphosphonothiolate

Butan-2-yl S-2-diisopropylaminoethyl propylphosphonothiolate

But-2-yl S-2-diisopropylaminoethyl propylphosphonothiolate

1-Methylpropyl S-2-diisopropylaminoethyl propylphosphonothiolate

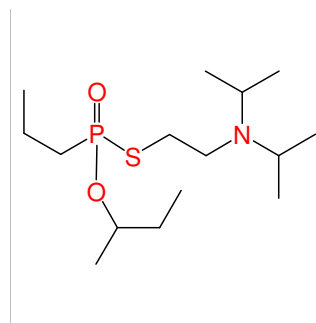

**Chemical name:** 3,5,5-Trimethylhexyl S-2-diisopropylaminoethyl propylphosphonothiolate

Schedule: 1A03

CAS RN: 959257-18-2

HS code: 2930.90

Key: 959257-18-2

Molecular formula: C<sub>20</sub>H<sub>44</sub>NO<sub>2</sub>PS

CAS Index Name: Phosphonothioic acid, propyl-, S-[2-(bis(1-methylethyl)amino)ethyl] O-(3,5,5-trimethylhexyl) ester

**IUPAC name:** 3,5,5-Trimethylhexyl S-2-diisopropylaminoethyl propylphosphonothioate

Synonyms: O-3,5,5-Trimethylhexyl S-2-diisopropylaminoethyl propylphosphonothiolate

O-3,5,5-Trimethylhexyl S-2-(diisopropylamino)ethyl propylphosphonothiolate

3,5,5-Trimethylhexyl S-2-(diisopropylamino)ethyl propylphosphonothiolate

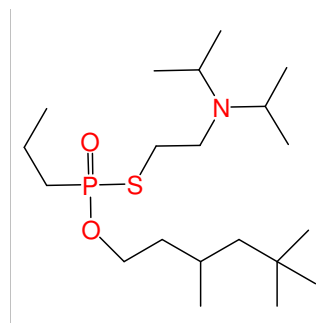

**Chemical name:** Propyl S-2-dimethylaminoethyl propylphosphonothiolate

Schedule: 1A03

CAS RN: 959259-05-3

HS code: 2930.90

Key: 959259-05-3

Molecular formula: C<sub>10</sub>H<sub>24</sub>NO<sub>2</sub>PS

CAS Index Name: Phosphonothioic acid, propyl-, S-[2-(dimethylamino)ethyl] O-propyl ester

**IUPAC name:** Propyl S-2-dimethylaminoethyl propylphosphonothioate

Synonyms: Propyl S-2-(dimethylamino)ethyl propylphosphonothiolate

O-Propyl S-2-dimethylaminoethyl propylphosphonothiolate

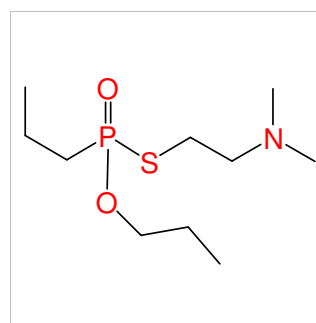

**Chemical name:** 4-Methylpentyl S-2-dimethylaminoethyl propylphosphonothiolate

Schedule: 1A03

CAS RN: 959259-06-4

HS code: 2930.90

Key: 959259-06-4

Molecular formula: C<sub>13</sub>H<sub>30</sub>NO<sub>2</sub>PS

CAS Index Name: Phosphonothioic acid, propyl-, S-[2-(dimethylamino)ethyl] O-(4-methylpentyl) ester

**IUPAC name:** 4-Methylpentyl S-2-dimethylaminoethyl propylphosphonothioate

Synonyms: O-4-Methylpentyl S-2-dimethylaminoethyl propylphosphonothiolate  
4-Methylpentyl S-2-(dimethylamino)ethyl propylphosphonothiolate

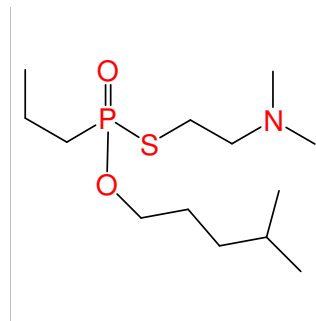

**Chemical name:** Cyclohexylmethyl S-2-diisopropylaminoethyl propylphosphonothiolate

Schedule: 1A03

CAS RN: 959268-47-4

HS code: 2930.90

Key: 959268-47-4

Molecular formula: C<sub>18</sub>H<sub>38</sub>NO<sub>2</sub>PS

CAS Index Name: Phosphonothioic acid, propyl-, S-[2-(bis(1-methylethyl)amino)ethyl] O-cyclohexylmethyl ester

**IUPAC name:** Cyclohexylmethyl S-2-diisopropylaminoethyl propylphosphonothioate

Synonyms: O-Cyclohexylmethyl S-2-diisopropylaminoethyl propylphosphonothiolate  
O-Cyclohexylmethyl S-2-(diisopropylamino)ethyl propylphosphonothiolate  
Cyclohexylmethyl S-2-(diisopropylamino)ethyl propylphosphonothiolate

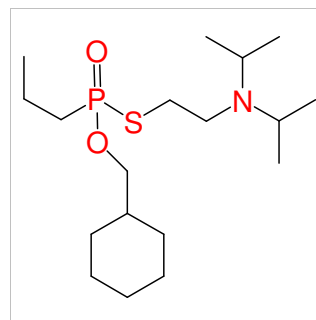

**Chemical name:** Decyl S-2-diethylaminoethyl methylphosphonothiolate

Schedule: 1A03

CAS RN: 959288-69-8

HS code: 2930.90

Key: 959288-69-8

Molecular formula: C<sub>17</sub>H<sub>38</sub>NO<sub>2</sub>PS

CAS Index Name: Phosphonothioic acid, methyl-, S-[2-(diethylamino)ethyl] O-decyl ester

**IUPAC name:** Decyl S-2-diethylaminoethyl methylphosphonothioate

Synonyms: O-Decyl S-[2-(diethylamino)ethyl] methylphosphonothiolate

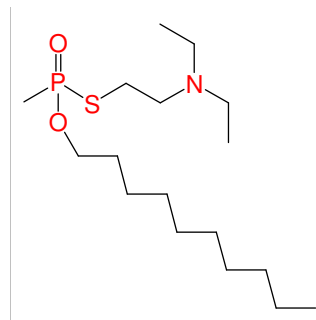

**Chemical name:** Propyl S-2-diethylaminoethyl propylphosphonothiolate

Schedule: 1A03

CAS RN: 959288-70-1

HS code: 2930.90

Key: 959288-70-1

Molecular formula: C<sub>12</sub>H<sub>28</sub>NO<sub>2</sub>PS

CAS Index Name: Phosphonothioic acid, propyl-, S-[2-(diethylamino)ethyl] O-propyl ester

**IUPAC name:** Propyl S-2-diethylaminoethyl propylphosphonothioate

Synonyms: Propyl S-2-(diethylamino)ethyl propylphosphonothiolate

O-Propyl S-2-diethylaminoethyl propylphosphonothiolate

O-Propyl S-2-(diethylamino)ethyl propylphosphonothiolate

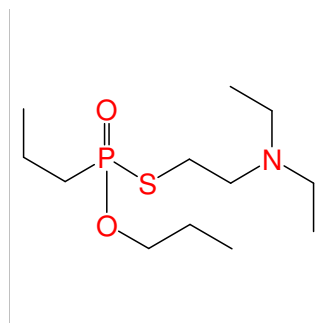

**Chemical name:** 2-Methylpentyl S-2-diethylaminoethyl ethylphosphonothiolate

Schedule: 1A03

CAS RN: 959288-71-2

HS code: 2930.90

Key: 959288-71-2

Molecular formula: C<sub>14</sub>H<sub>32</sub>NO<sub>2</sub>PS

CAS Index Name: Phosphonothioic acid, ethyl-, S-[2-(diethylamino)ethyl] O-(2-methylpentyl) ester

**IUPAC name:** 2-Methylpentyl S-2-diethylaminoethyl ethylphosphonothioate

Synonyms: O-2-Methylpentyl S-2-diethylaminoethyl ethylphosphonothiolate

O-2-Methylpentyl S-[2-(diethylamino)ethyl] ethylphosphonothiolate

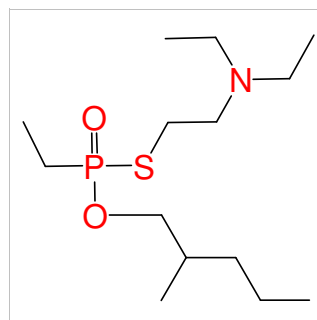

**Chemical name:** Isopropyl S-2-diisopropylaminoethyl isopropylphosphonothiolate

Schedule: 1A03

CAS RN: 959289-50-0

HS code: 2930.90

Key: 959289-50-0

Molecular formula: C<sub>14</sub>H<sub>32</sub>NO<sub>2</sub>PS

CAS Index Name: Phosphonothioic acid, 1-methylethyl-, S-[2-(bis(1-methylethyl)amino)ethyl] O-(1-methylethyl) ester

**IUPAC name:** Isopropyl S-2-diisopropylaminoethyl isopropylphosphonothioate

Synonyms: Phosphonothioic acid, 1-methylethyl-, S-[2-(bis(1-methylethyl)amino)ethyl] O-1-methylethyl ester

O-Isopropyl S-2-diisopropylaminoethyl isopropylphosphonothiolate

Isopropyl S-2-(diisopropylamino)ethyl isopropylphosphonothiolate

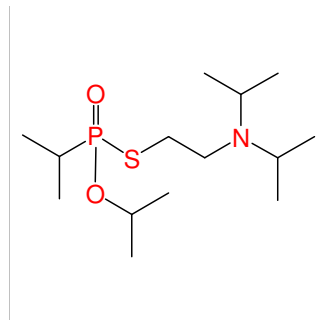

**Chemical name:** Ethyl S-2-dimethylaminoethyl ethylphosphonothiolate

Schedule: 1A03

CAS RN: 98543-25-0

HS code: 2930.90

Key: 98543-25-0

Molecular formula: C<sub>8</sub>H<sub>20</sub>NO<sub>2</sub>PS

CAS Index Name: Phosphonothioic acid, ethyl-, S-[2-(dimethylamino)ethyl] O-ethyl ester

**IUPAC name:** Ethyl S-2-dimethylaminoethyl ethylphosphonothioate

Synonyms: O-Ethyl S-2-dimethylaminoethyl ethylphosphonothiolate

O-Ethyl S-2-(dimethylamino)ethyl ethylphosphonothiolate

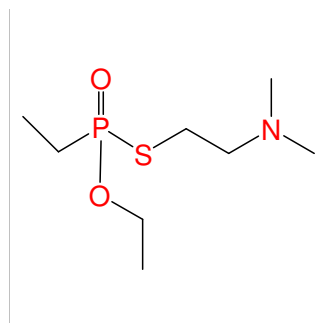

**Chemical name:** Ethyl S-2-diethylaminoethyl isopropylphosphonothiolate

Schedule: 1A03

CAS RN: 99991-06-7

HS code: 2930.90

Key: 99991-06-7

Molecular formula: C<sub>11</sub>H<sub>26</sub>NO<sub>2</sub>PS

CAS Index Name: Phosphonothioic acid, 1-methylethyl-, S-[2-(diethylamino)ethyl] O-ethyl ester

**IUPAC name:** Ethyl S-2-diethylaminoethyl isopropylphosphonothioate

Synonyms: Phosphonothioic acid, isopropyl-, S-(2-diethylaminoethyl) O-ethyl ester

O-Ethyl S-2-diethylaminoethyl isopropylphosphonothiolate

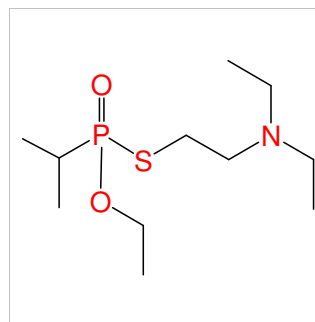

**Chemical name:** Ethyl S-2-diethylaminoethyl propylphosphonothiolate

Schedule: 1A03

CAS RN: 99991-07-8

HS code: 2930.90

Key: 99991-07-8

Molecular formula: C<sub>11</sub>H<sub>26</sub>NO<sub>2</sub>PS

CAS Index Name: Phosphonothioic acid, propyl-, S-[2-(diethylamino)ethyl] O-ethyl ester

**IUPAC name:** Ethyl S-2-diethylaminoethyl propylphosphonothioate

Synonyms: O-Ethyl S-2-diethylaminoethyl propylphosphonothiolate

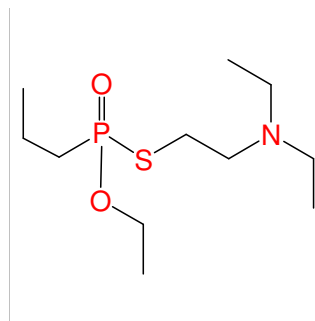

**Chemical name:** S-2-Dipropylaminoethyl isopropylphosphonothiolate

Schedule: 1A03

CAS RN: HS code: 2930.90

Key: H-I1A3-PP

Molecular formula: C<sub>11</sub>H<sub>26</sub>NO<sub>2</sub>PS

CAS Index Name: Phosphonothioic acid, 1-methylethyl-, S-[2-(dipropylamino)ethyl] ester

**IUPAC name:** S-2-Dipropylaminoethyl isopropylphosphonothioate

Synonyms: O-Hydrogen S-2-dipropylaminoethyl isopropylphosphonothiolate

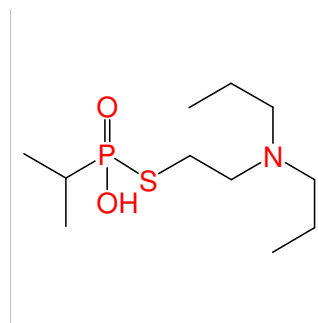

**Chemical name:** S-2-Dipropylaminoethyl propylphosphonothiolate

Schedule: 1A03

CAS RN: HS code: 2930.90

Key: H-P1A3-PP

Molecular formula: C<sub>11</sub>H<sub>26</sub>NO<sub>2</sub>PS

CAS Index Name: Phosphonothioic acid, propyl-, S-[2-(dipropylamino)ethyl] ester

**IUPAC name:** S-2-Dipropylaminoethyl propylphosphonothioate

Synonyms: O-Hydrogen S-2-dipropylaminoethyl propylphosphonothiolate

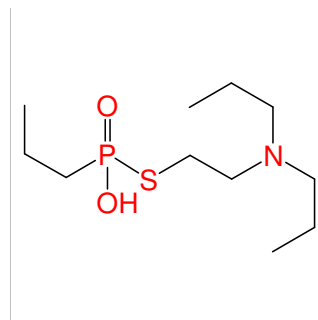

**Chemical name:** Bis(2-chloroethyl-[1-14C])sulfide

Schedule: 1A04

CAS RN: HS code: 2845.90

Key: (505-60-2)-[1,1-14C]

Molecular formula: C<sub>2</sub> (14C)<sub>2</sub> H<sub>8</sub>Cl<sub>2</sub>S

CAS Index Name: (1-14C)Ethane, 1,1'-thiobis(2-chloro-

**IUPAC name:** 1,1'-Thiobis[2-chloro(1-14C)ethane]

Synonyms: 1,1'-Sulfanediylbis[2-chloro(1-14C)ethane]

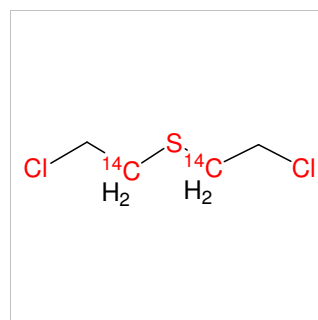

**Chemical name:** (2-Chloroethyl)(2-chloroethyl-[1,2-14C])sulfide

Schedule: 1A04

CAS RN: HS code: 2845.90

Key: (505-60-2)-[1,2-14C]

Molecular formula: C<sub>2</sub> (14C)<sub>2</sub> H<sub>8</sub>Cl<sub>2</sub>S

CAS Index Name: (1,2-14C)Ethane, 1,1'-thiobis(2-chloro-

**IUPAC name:** 1,1'-Thiobis[2-chloro(1,2-14C)ethane]

Synonyms:

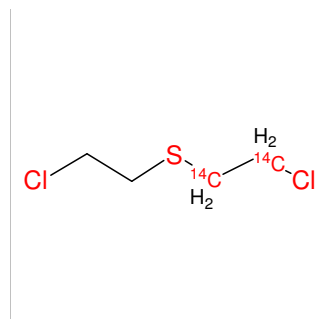



**Chemical name:** (2-Chloroethyl)(2-chloroethyl-[1-14C])ulfide

Schedule: 1A04

CAS RN: HS code: 2845.90

Key: (505-60-2)-[1-14C]

Molecular formula: C3 (14C) H8Cl2S

CAS Index Name: (1-14C)Ethane, 2-chloro-1-[(2-chloroethyl)thio]-

**IUPAC name:** 2-chloro-1-[(2-chloroethyl)thio](1-14C)ethane

Synonyms: 2-chloro-1-[(2-chloroethyl)sulfanyl](1-14C)ethane

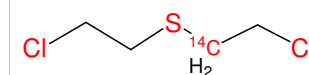

**Chemical name:** Mixture of Bis(2-chloroethyl)sulfide and 13C2-Bis(2-chloroethyl)sulfide

Schedule: 1A04

CAS RN: HS code: 2845.90

Key: (505-60-2)-[13C]

Molecular formula: C4H8Cl2S . C2 (13C) C2H8Cl2S

CAS Index Name:

**IUPAC name:**

Synonyms:

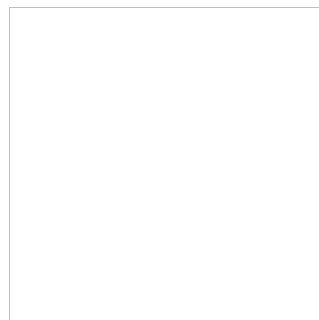

**Chemical name:** Bis(2-chloroethyl-[2-14C])ulfide

Schedule: 1A04

CAS RN: HS code: 2845.90

Key: (505-60-2)-[2,2-14C]

Molecular formula: C2 (14C)2 H8Cl2S

CAS Index Name: (2-14C)Ethane, 1,1'-thiobis(2-chloro-

**IUPAC name:** 1,1'-Thiobis[2-chloro(2-14C)ethane]

Synonyms:

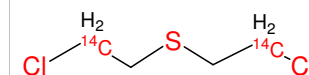

**Chemical name:** 1,4-Bis(2-chloroethylthio)butane

Schedule: 1A04

CAS RN: 142868-93-7 HS code: 2930.90

Key: 142868-93-7

Molecular formula: C8H16Cl2S2

CAS Index Name: Butane, 1,4-bis[(2-chloroethyl)thio]-

**IUPAC name:** 1,4-bis[(2-chloroethyl)thio]butane

Synonyms: 1,4-Bis[(2-chloroethyl)sulfanyl]butane

1,4-Bis(2-chloroethylthio)-n-butane

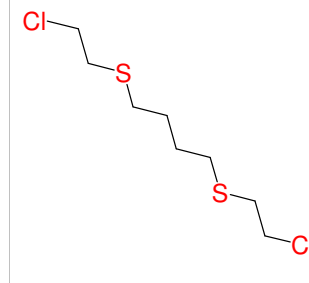

**Chemical name:** 1,5-Bis(2-chloroethylthio)pentane

Schedule: 1A04

CAS RN: 142868-94-8

HS code: 2930.90

Key: 142868-94-8

Molecular formula: C<sub>9</sub>H<sub>18</sub>Cl<sub>2</sub>S<sub>2</sub>

CAS Index Name: Pentane, 1,5-bis[(2-chloroethyl)thio]-

**IUPAC name:** 1,5-bis[(2-chloroethyl)thio]pentane

Synonyms: 1,5-Bis[(2-chloroethyl)sulfanyl]pentane

1,5-Bis(2-chloroethylthio)-n-pentane

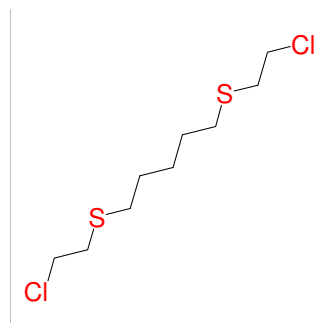

**Chemical name:** Mixture of Bis(2-chloroethyl)sulfide (CAS RN 505-60-2) and Bis(2-chloroethylthioethyl)ether (CAS RN 63918-89-8)

Schedule: 1A04

CAS RN: 172672-28-5

HS code:

Key: 172672-28-5

Molecular formula: C<sub>8</sub>H<sub>16</sub>Cl<sub>2</sub>O<sub>2</sub>S<sub>2</sub> . C<sub>4</sub>H<sub>8</sub>Cl<sub>2</sub>S

CAS Index Name: Ethane, 1,1'-oxybis[2-[(2-chloroethyl)thio]-, mixt. with 1,1'-thiobis[2-chloroethane] (9CI)

**IUPAC name:**

Synonyms: HT Mixture

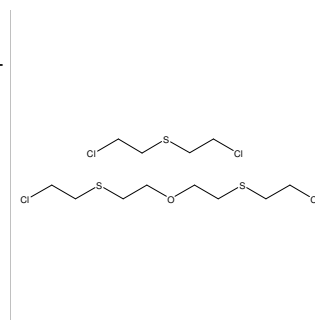

**Chemical name:** Bis(2-chloroethyl-d<sub>4</sub>)sulfide

Schedule: 1A04

CAS RN: 176327-97-2

HS code: 2845.90

Key: 176327-97-2

Molecular formula: C<sub>4</sub>D<sub>8</sub>Cl<sub>2</sub>S

CAS Index Name: Ethane-1,1,2,2-d<sub>4</sub>, 1,1'-thiobis(2-chloro)-

**IUPAC name:** 1,1'-Thiobis(2-chloroethane-d<sub>4</sub>)

Synonyms: Bis(2-chloroethyl-d<sub>4</sub>)sulfide

1-Chloro-2-[[2-chloro(2H<sub>4</sub>)ethyl]sulfanyl](2H<sub>4</sub>)ethane

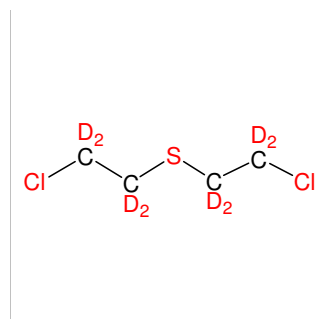

**Chemical name:** (2-Chloroethyl)(2-chloroethyl-[2-<sup>14</sup>C])sulfide

Schedule: 1A04

CAS RN: 223129-69-9

HS code: 2845.90

Key: 223129-69-9

Molecular formula: C<sub>3</sub> (<sup>14</sup>C) H<sub>8</sub>Cl<sub>2</sub>S

CAS Index Name: Ethane-<sup>14</sup>C, 1-chloro-2-[(2-chloroethyl)thio]-

**IUPAC name:** 1-chloro-2-[(2-chloroethyl)thio](<sup>14</sup>C)ethane

Synonyms: 1-chloro-2-[(2-chloroethyl)sulfanyl](<sup>14</sup>C)ethane

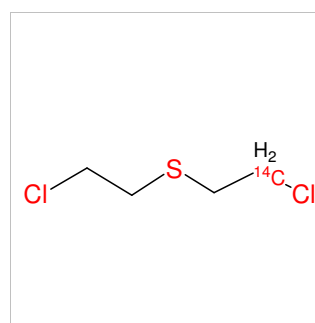

**Chemical name:** 2-Chloroethylchloromethylsulfide

Schedule: 1A04

CAS RN: 2625-76-5

HS code: 2930.90

Key: 2625-76-5

Molecular formula: C<sub>3</sub>H<sub>6</sub>Cl<sub>2</sub>S

CAS Index Name: Ethane, 1-chloro-2-[(chloromethyl)thio]-

**IUPAC name:** 1-Chloro-2-[(chloromethyl)thio]ethane

Synonyms: Sulfide, 2-chloroethyl chloromethyl  
2-Chloroethyl chloromethyl sulfide  
1-Chloro-2-[(chloromethyl)sulfanyl]ethane  
(2-Chloroethyl)(chloromethyl)sulfane

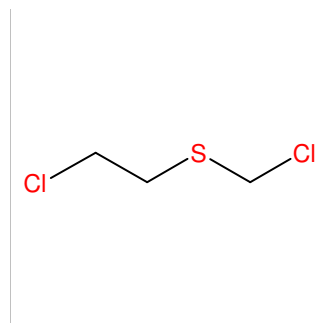

**Chemical name:** 1,2-Bis(2-chloroethylthio)ethane

Schedule: 1A04

CAS RN: 3563-36-8

HS code: 2930.90

Key: 3563-36-8

Molecular formula: C<sub>6</sub>H<sub>12</sub>Cl<sub>2</sub>S<sub>2</sub>

CAS Index Name: Ethane, 1,2-bis[(2-chloroethyl)thio]-

**IUPAC name:** 1,2-Bis(2-chloroethylthio)ethane

Synonyms: Sesquimustard Q  
Sesquimustard  
Bis(2-chloroethylthio)ethane  
Agent Q  
3,6-Dithia-1,8-octanedichloride  
1-Chloro-2-({2-[(2-chloroethyl)sulfanyl]ethyl}sulfanyl)ethane  
1,8-Dichloro-3,6-dithiaoctane  
1,1'-(ethane-1,2-diyldisulfanediy)bis(2-chloroethane)

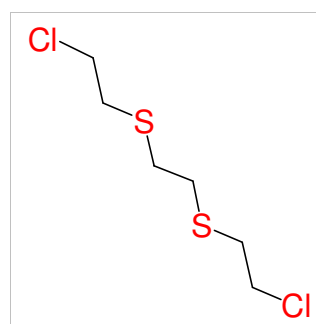

**Chemical name:** Mixture of Bis(2-chloroethyl)sulfide (CAS RN 505-60-2) and 2-Chlorovinyl dichloroarsine (CAS RN 541-25-3)

Schedule: 1A04

CAS RN: 378791-32-3

HS code:

Key: 378791-32-3

Molecular formula: C<sub>4</sub>H<sub>8</sub>Cl<sub>2</sub>S . C<sub>2</sub>H<sub>2</sub>AsCl<sub>3</sub>

CAS Index Name: Arsonous dichloride, (2-chloroethenyl)-, mixt. with 1,1'-thiobis[2-chloroethane] (9CI)

**IUPAC name:**

Synonyms: HL Mixture

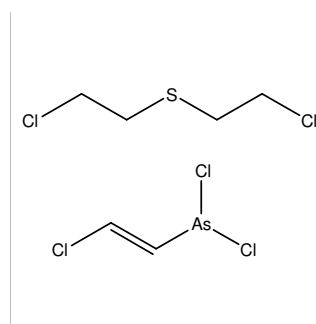

**Chemical name:** Bis(2-chloroethyl)sulfide

Schedule: 1A04

CAS RN: 505-60-2

HS code: 2930.90

Key: 505-60-2

Molecular formula: C<sub>4</sub>H<sub>8</sub>Cl<sub>2</sub>S

CAS Index Name: Ethane, 1,1'-thiobis[2-chloro-

**IUPAC name:** 1,1'-Thiobis(2-chloroethane)

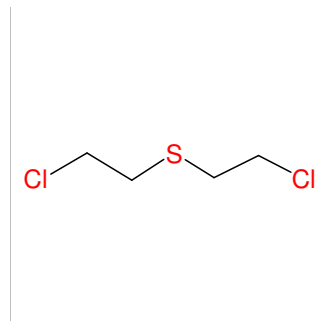

Synonyms: Mustard

2,2'-Dichlorodiethyl sulfide

2,2'-Dichloroethyl sulfide

Agent HD

Bis(2-chloroethyl)sulfide

Bis( $\beta$ -chloroethyl) sulfide

Di-2-chloroethyl sulfide

HD

HD (chemical warfare agent)

Iperyt

1-Chloro-2-( $\beta$ -chloroethylthio)ethane

Kampstoff Lost

Yperite

Mustard gas

S-Lost

S-Yperite

Senfgas

$\beta,\beta'$ -Dichlorodiethyl sulfide

$\beta,\beta'$ -Dichloroethyl sulfide

Sulfide, bis(2-chloroethyl)

Sulfur mustard

Sulfur mustard gas

Yellow cross liquid

Iprit

**Chemical name:** Bis(2-chloroethylthio)methane

Schedule: 1A04

CAS RN: 63869-13-6

HS code: 2930.90

Key: 63869-13-6

Molecular formula: C<sub>5</sub>H<sub>10</sub>Cl<sub>2</sub>S<sub>2</sub>

CAS Index Name: Ethane, 1,1'-[methylenebis(thio)]bis[2-chloro-

**IUPAC name:** 1,1'-[Methylenebis(thio)]bis(2-chloroethane)

Synonyms: 1-Chloro-2-({[(2-chloroethyl)sulfanyl]methyl}sulfanyl)ethane

1,1'(Methylenedisulfanediy)bis(2-chloroethane)

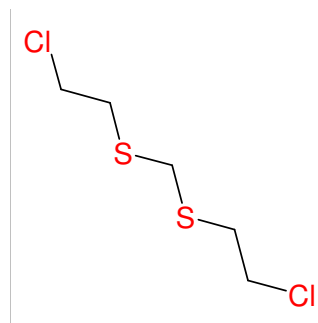

**Chemical name:** 1,3-Bis(2-chloroethylthio)propane

Schedule: 1A04

CAS RN: 63905-10-2

HS code: 2930.90

Key: 63905-10-2

Molecular formula: C<sub>7</sub>H<sub>14</sub>Cl<sub>2</sub>S<sub>2</sub>

CAS Index Name: Propane, 1,3-bis[(2-chloroethyl)thio]-

**IUPAC name:** 1,3-Bis[(2-chloroethyl)thio]propane

Synonyms: 1,3-Bis[(2-chloroethyl)sulfanyl]propane

1,3-Bis(2-chloroethylthio)-n-propane

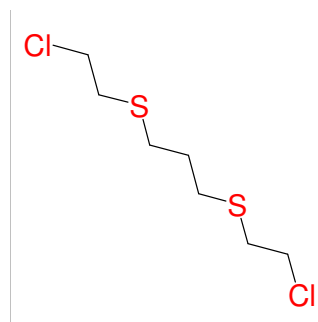

**Chemical name:** Bis(2-chloroethylthioethyl)ether

Schedule: 1A04

CAS RN: 63918-89-8

HS code: 2930.90

Key: 63918-89-8

Molecular formula: C<sub>8</sub>H<sub>16</sub>Cl<sub>2</sub>OS<sub>2</sub>

CAS Index Name: Ethane, 1,1'-oxybis[2-[(2-chloroethyl)thio]-

**IUPAC name:** Bis{2-[(2-chloroethyl)thio]ethyl} ether

Synonyms: O-Mustard

Bis{2-[(2-chloroethyl)sulfanyl]ethyl} ether

Bis(2-chloroethylthioethyl) ether

Agent T

1,1'-[Oxybis(ethane-2,1-diylthio)]bis(2-chloroethane)

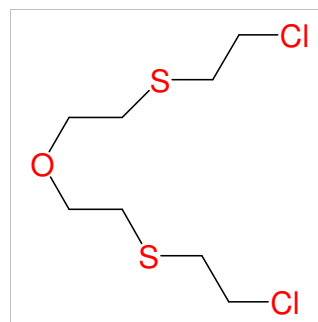

**Chemical name:** Bis(2-chloroethylthiomethyl)ether

Schedule: 1A04

CAS RN: 63918-90-1

HS code: 2930.90

Key: 63918-90-1

Molecular formula: C<sub>6</sub>H<sub>12</sub>Cl<sub>2</sub>OS<sub>2</sub>

CAS Index Name: Ethane, 1,1'-[oxybis(methylenethio)]bis[2-chloro-

**IUPAC name:** Bis{[(2-chloroethyl)thio]methyl} ether

Synonyms: Bis{[(2-chloroethyl)sulfanyl]methyl} ether

Bis(2-chloroethylthiomethyl) ether

1,1'-[Oxybis(methylenethio)]bis(2-chloroethane)

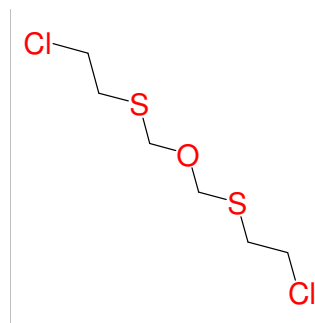

**Chemical name:** Bis(2-chloroethyl)sulfide-35S

Schedule: 1A04

CAS RN: 6755-76-6

HS code: 2844.40

Key: 6755-76-6

Molecular formula: C<sub>4</sub>H<sub>8</sub>Cl<sub>2</sub>(<sup>35</sup>S)

CAS Index Name: Ethane, 1,1'-(thio-<sup>35</sup>S)bis[2-chloro-

**IUPAC name:** 1,1'-(Thio-<sup>35</sup>S)bis(2-chloroethane)

Synonyms: 1-chloro-2-[(2-chloroethyl)thio-<sup>35</sup>S]ethane

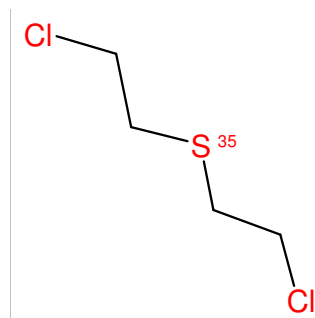

**Chemical name:** Bis(2-chlorovinyl-[1,2-<sup>14</sup>C])chloroarsine

Schedule: 1A05

CAS RN:

HS code: 2845.90

Key: (40334-69-8)-[1,2-<sup>14</sup>C]

Molecular formula: (<sup>14</sup>C)<sub>4</sub> H<sub>4</sub>AsCl<sub>3</sub>

CAS Index Name: Arsinous chloride, bis[2-chloro(1,2-<sup>14</sup>C)ethenyl]-

**IUPAC name:** Bis[2-chloro(1,2-<sup>14</sup>C)vinyl]chloroarsine

Synonyms:

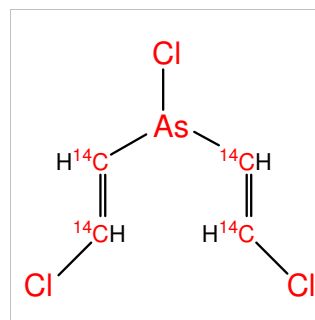

**Chemical name:** Tris(2-chlorovinyl-[1,2-<sup>14</sup>C])arsine

Schedule: 1A05

CAS RN:

HS code: 2845.90

Key: (40334-70-1)-[1,2-<sup>14</sup>C]

Molecular formula: (<sup>14</sup>C)<sub>6</sub> H<sub>6</sub>AsCl<sub>3</sub>

CAS Index Name: Arsine, tris[2-chloro(1,2-<sup>14</sup>C)ethenyl]-

**IUPAC name:** Tris[2-chloro(1,2-<sup>14</sup>C)vinyl]arsine

Synonyms:

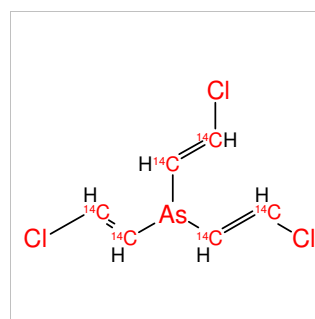

**Chemical name:** 2-Chlorovinyl-[1,2-<sup>14</sup>C]-dichloroarsine

Schedule: 1A05

CAS RN: HS code: 2845.90

Key: (541-25-3)-[1,2-<sup>14</sup>C]

Molecular formula: (14C)<sub>2</sub>H<sub>2</sub>AsCl<sub>3</sub>

CAS Index Name: Arsonous dichloride, [2-chloro(1,2-<sup>14</sup>C)ethenyl]-

**IUPAC name:** 2-Chloro(1,2-<sup>14</sup>C)vinyl-dichloroarsine

Synonyms:

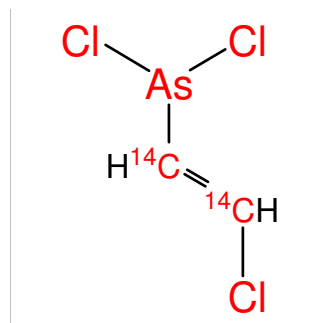

**Chemical name:** (Z)-2-Chlorovinyl-dichloroarsine

Schedule: 1A05

CAS RN: 34461-56-8 HS code: 2931.90

Key: 34461-56-8

Molecular formula: C<sub>2</sub>H<sub>2</sub>AsCl<sub>3</sub>

CAS Index Name: Arsonous dichloride, [(1Z)-2-chloroethenyl]-

**IUPAC name:** (Z)-2-Chlorovinyl-dichloroarsine

Synonyms: cis-2-Chlorovinyl-dichloroarsine

(Z)-dichloro(2-chlorovinyl)arsine

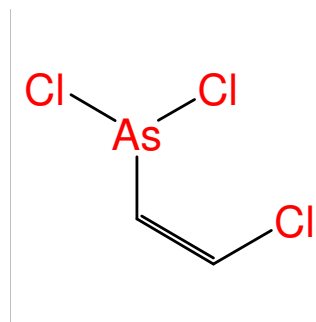

**Chemical name:** Bis(2-chlorovinyl)chloroarsine

Schedule: 1A05

CAS RN: 40334-69-8 HS code: 2931.90

Key: 40334-69-8

Molecular formula: C<sub>4</sub>H<sub>4</sub>AsCl<sub>3</sub>

CAS Index Name: Arsinous chloride, bis(2-chloroethenyl)-

**IUPAC name:** Bis(2-chlorovinyl)chloroarsine

Synonyms: Lewisite 2

Arsine, chlorobis(2-chlorovinyl)-

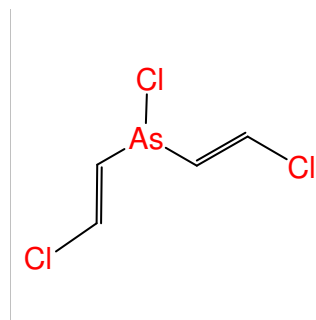

**Chemical name:** Tris(2-chlorovinyl)arsine

Schedule: 1A05

CAS RN: 40334-70-1 HS code: 2931.90

Key: 40334-70-1

Molecular formula: C<sub>6</sub>H<sub>6</sub>AsCl<sub>3</sub>

CAS Index Name: Arsine, tris(2-chloroethenyl)-

**IUPAC name:** Tris(2-chlorovinyl)arsine

Synonyms: Lewisite 3

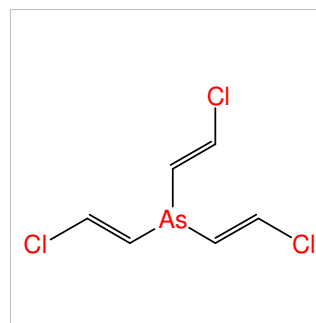

**Chemical name:** 2-Chlorovinyl dichloroarsine

Schedule: 1A05

CAS RN: 541-25-3

HS code: 2931.90

Key: 541-25-3

Molecular formula: C<sub>2</sub>H<sub>2</sub>AsCl<sub>3</sub>

CAS Index Name: Arsonous dichloride, (2-chloroethenyl)-

**IUPAC name:** 2-Chlorovinyl dichloroarsine

Synonyms: Luizyt

Lewisite 1

Lewisite (arsenic compound)

Lewisite

Dichloro(2-chlorovinyl)arsine

Chlorovinylarsine dichloride

Arsine, dichloro(2-chlorovinyl)-

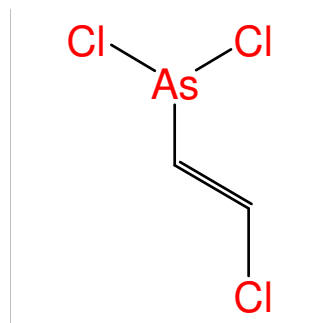

**Chemical name:** Mixture of 2-Chlorovinyl dichloroarsine (CAS RN 541-25-3), Bis(2-chlorovinyl)chloroarsine (CAS RN 40334-69-8) and Tris(2-chlorovinyl)arsine (CAS RN 40334-70-1)

Schedule: 1A05

CAS RN: 852960-64-6

HS code:

Key: 852960-64-6

Molecular formula: C<sub>6</sub>H<sub>6</sub>AsCl<sub>3</sub> . C<sub>4</sub>H<sub>4</sub>AsCl<sub>3</sub> . C<sub>2</sub>H<sub>2</sub>AsCl<sub>3</sub>

CAS Index Name: Arsonous dichloride, (2-chloroethenyl)-, mixt. with bis(2-chloroethenyl)arsinous chloride and tris(2-chloroethenyl)arsine (9Cl)

**IUPAC name:**

Synonyms: Mixture of Lewisites 1, 2 and 3

Mixture of 2-Chlorovinyl dichloroarsine, Bis(2-chlorovinyl)chloroarsine, Tris(2-chlorovinyl)arsine

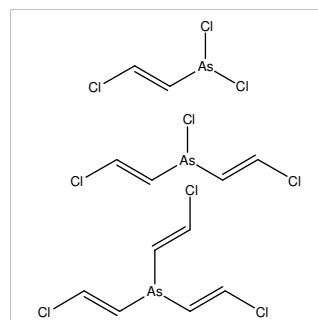

**Chemical name:** (2-Chloroethyl)(2-chloroethyl-[1,2-<sup>14</sup>C])methylamine

Schedule: 1A06

CAS RN:

HS code: 2845.90

Key: (51-75-2)-E[1,2-<sup>14</sup>C]Cl

Molecular formula: C<sub>3</sub> (<sup>14</sup>C)<sub>2</sub> H<sub>11</sub> Cl<sub>2</sub> N

CAS Index Name: (14C<sub>2</sub>)Ethanamine, 2-chloro-N-(2-chloroethyl)-N-methyl-

**IUPAC name:** 2-Chloro-N-(2-chloroethyl)-N-methyl(<sup>14</sup>C<sub>2</sub>)ethanamine

Synonyms:

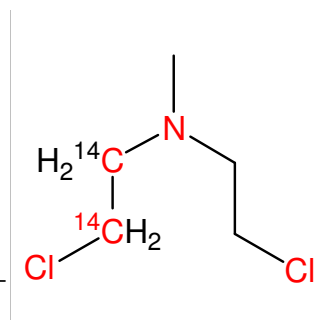



**Chemical name:** (2-Chloroethyl)(2-chloroethyl-[1-<sup>14</sup>C])methanamine

Schedule: 1A06

CAS RN: HS code: 2845.90

Key: (51-75-2)-E[1-<sup>14</sup>C]Cl

Molecular formula: C<sub>4</sub> (14C) H<sub>11</sub>Cl<sub>2</sub>N

CAS Index Name: (1-<sup>14</sup>C)Ethanamine, 2-chloro-N-(2-chloroethyl)-N-methyl-

**IUPAC name:** 2-Chloro-N-(2-chloroethyl)-N-methyl(1-<sup>14</sup>C)ethanamine

Synonyms:

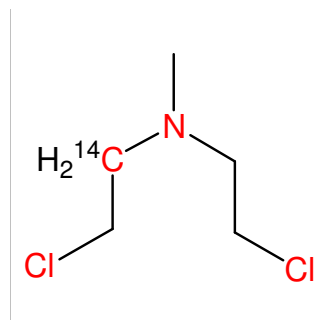

**Chemical name:** (2-Chloroethyl)(2-chloroethyl-[2-<sup>14</sup>C])methanamine

Schedule: 1A06

CAS RN: HS code: 2845.90

Key: (51-75-2)-E[2-<sup>14</sup>C]Cl

Molecular formula: C<sub>4</sub> (14C) H<sub>11</sub>Cl<sub>2</sub>N

CAS Index Name: (2-<sup>14</sup>C)Ethanamine, 2-chloro-N-(2-chloroethyl)-N-methyl-

**IUPAC name:** 2-Chloro-N-(2-chloroethyl)-N-methyl(2-<sup>14</sup>C)ethanamine

Synonyms:

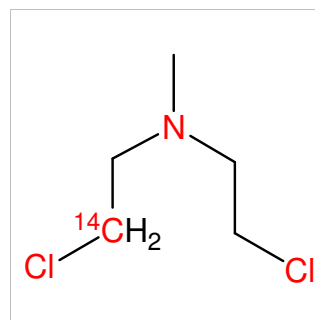

**Chemical name:** Bis(2-chloroethyl)methyl-[<sup>14</sup>C]-amine

Schedule: 1A06

CAS RN: HS code: 2845.90

Key: (51-75-2)-M[<sup>14</sup>C]

Molecular formula: C<sub>4</sub> (14C) H<sub>11</sub>Cl<sub>2</sub>N

CAS Index Name: Ethanamine, 2-chloro-N-(2-chloroethyl)-N-methyl-<sup>14</sup>C-

**IUPAC name:** 2-Chloro-N-(2-chloroethyl)-N-(<sup>14</sup>C)methylethanamine

Synonyms: 2,2'-Dichloro-N-methyl-[<sup>14</sup>C]-diethanamine

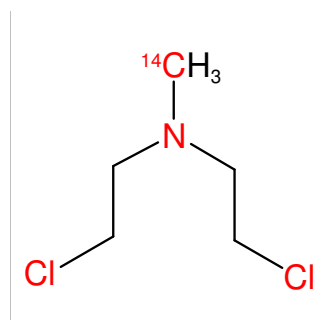

**Chemical name:** Bis(2-chloroethyl)ethyl-[1,2-<sup>14</sup>C]-amine

Schedule: 1A06

CAS RN: HS code: 2845.90

Key: (538-07-8)-E[1,2-<sup>14</sup>C]

Molecular formula: C<sub>4</sub> (14C)<sub>2</sub> H<sub>13</sub>Cl<sub>2</sub>N

CAS Index Name: Ethanamine, 2-chloro-N-(2-chloroethyl)-N-(<sup>14</sup>C)<sub>2</sub>ethyl-

**IUPAC name:** 2-Chloro-N-(2-chloroethyl)-N-(<sup>14</sup>C)<sub>2</sub>ethylethanamine

Synonyms:

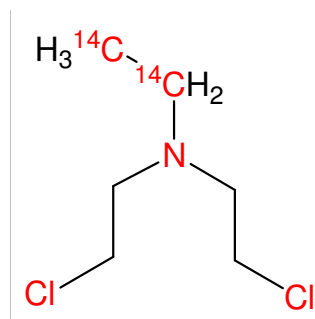

**Chemical name:** (2-Chloroethyl)(2-chloroethyl-[1,2-14C])ethanamine

Schedule: 1A06

CAS RN: HS code: 2845.90

Key: (538-07-8)-E[1,2-14C]Cl

Molecular formula: C<sub>4</sub> (14C)<sub>2</sub> H<sub>13</sub>Cl<sub>2</sub>N

CAS Index Name: (14C<sub>2</sub>)Ethanamine, 2-chloro-N-(2-chloroethyl)-N-ethyl-

**IUPAC name:** 2-Chloro-N-(2-chloroethyl)-N-ethyl(14C<sub>2</sub>)ethanamine

Synonyms:

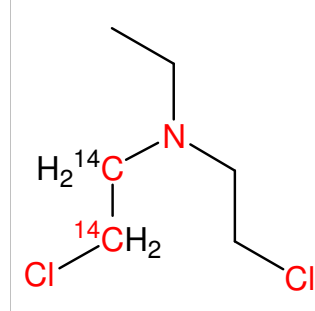

**Chemical name:** Bis(2-chloroethyl)ethyl-[1-14C]-amine

Schedule: 1A06

CAS RN: HS code: 2845.90

Key: (538-07-8)-E[1-14C]

Molecular formula: C<sub>5</sub> (14C) H<sub>13</sub>Cl<sub>2</sub>N

CAS Index Name: Ethanamine, 2-chloro-N-(2-chloroethyl)-N-ethyl-(1-14C)-

**IUPAC name:** 2-Chloro-N-(2-chloroethyl)-N-[(1-14C)ethyl]ethanamine

Synonyms:

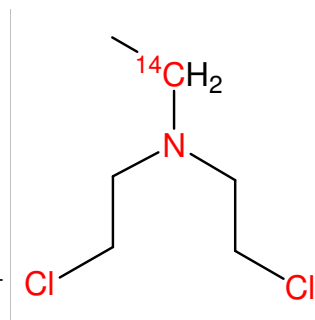

**Chemical name:** (2-Chloroethyl)(2-chloroethyl-[1-14C])ethanamine

Schedule: 1A06

CAS RN: HS code: 2845.90

Key: (538-07-8)-E[1-14C]Cl

Molecular formula: C<sub>5</sub> (14C) H<sub>13</sub>Cl<sub>2</sub>N

CAS Index Name: (1-14C)Ethanamine, 2-chloro-N-(2-chloroethyl)-N-ethyl-

**IUPAC name:** 2-Chloro-N-(2-chloroethyl)-N-ethyl(1-14C)ethanamine

Synonyms:

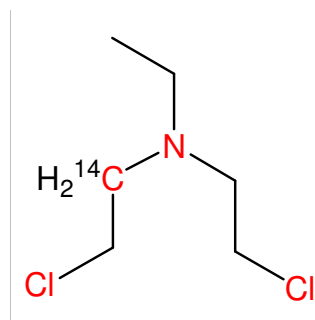

**Chemical name:** Bis(2-chloroethyl)ethyl-[2-14C]-amine

Schedule: 1A06

CAS RN: HS code: 2845.90

Key: (538-07-8)-E[2-14C]

Molecular formula: C<sub>5</sub> (14C) H<sub>13</sub>Cl<sub>2</sub>N

CAS Index Name: Ethanamine, 2-chloro-N-(2-chloroethyl)-N-[(2-14C)ethyl]-

**IUPAC name:** 2-Chloro-N-(2-chloroethyl)-N-[(2-14C)ethyl]ethanamine

Synonyms:

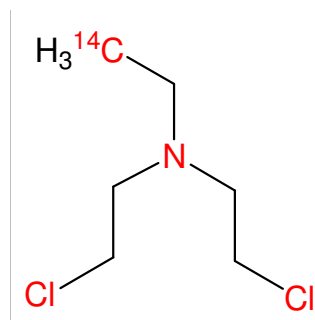

**Chemical name:** (2-Chloroethyl)(2-chloroethyl-[2-14C])ethylamine

Schedule: 1A06

CAS RN: HS code: 2845.90

Key: (538-07-8)-E[2-14C]Cl

Molecular formula: C<sub>5</sub> (14C) H<sub>13</sub>Cl<sub>2</sub>N

CAS Index Name: (2-14C)Ethanamine, 2-chloro-N-(2-chloroethyl)-N-ethyl-

**IUPAC name:** 2-Chloro-N-(2-chloroethyl)-N-ethyl(2-14C)ethanamine

Synonyms:

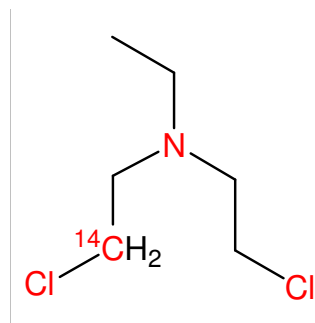

**Chemical name:** d12-tris(2-chloroethyl)amine

Schedule: 1A06

CAS RN: HS code:

Key: (555-77-1)-d12

Molecular formula: C<sub>6</sub>D<sub>12</sub>Cl<sub>3</sub>N

CAS Index Name:

**IUPAC name:**

Synonyms:

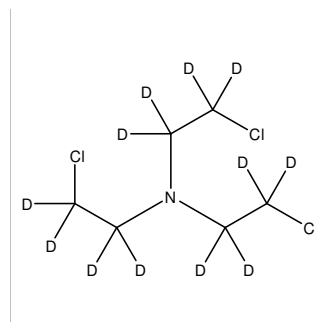

**Chemical name:** Bis(2-chloroethyl)(2-chloroethyl-[14C2])amine

Schedule: 1A06

CAS RN: HS code: 2845.90

Key: (555-77-1)-E[1,2-14C]

Molecular formula: C<sub>4</sub> (14C)<sub>2</sub> H<sub>12</sub>Cl<sub>3</sub>N

CAS Index Name: (14C<sub>2</sub>)Ethanamine, 2-chloro-N,N-bis(2-chloroethyl)-

**IUPAC name:** 2-Chloro-N,N-bis(2-chloroethyl)(14C<sub>2</sub>)ethanamine

Synonyms:

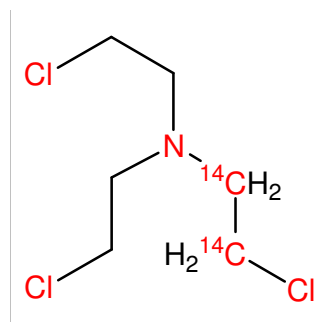

**Chemical name:** Bis(2-chloroethyl)(2-chloroethyl-[1-14C])amine

Schedule: 1A06

CAS RN: HS code: 2845.90

Key: (555-77-1)-E[1-14C]

Molecular formula: C<sub>5</sub> (14C) H<sub>12</sub>Cl<sub>3</sub>N

CAS Index Name: (1-14C)Ethanamine, 2-chloro-N,N-bis(2-chloroethyl)-

**IUPAC name:** 2-Chloro-N,N-bis(2-chloroethyl)(1-14C)ethanamine

Synonyms:

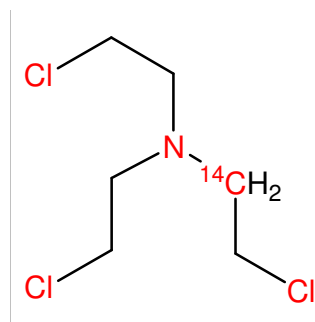

**Chemical name:** Bis(2-chloroethyl)(2-chloroethyl-[2-<sup>14</sup>C])amine

Schedule: 1A06

CAS RN: HS code: 2845.90

Key: (555-77-1)-E[2-<sup>14</sup>C]

Molecular formula: C<sub>5</sub> (14C) H<sub>12</sub>Cl<sub>3</sub>N

CAS Index Name: (2-<sup>14</sup>C)Ethanamine, 2-chloro-N,N-bis(2-chloroethyl)-

**IUPAC name:** 2-Chloro-N,N-bis(2-chloroethyl)(2-<sup>14</sup>C)ethanamine

Synonyms:

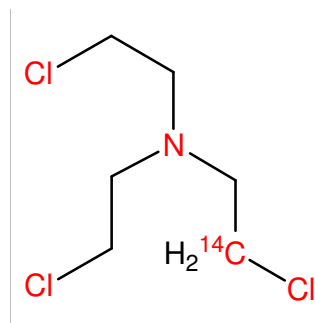

**Chemical name:** Bis(2-chloroethyl)methylamine

Schedule: 1A06

CAS RN: 51-75-2 HS code: 2921.19

Key: 51-75-2

Molecular formula: C<sub>5</sub>H<sub>11</sub>Cl<sub>2</sub>N

CAS Index Name: Ethanamine, 2-chloro-N-(2-chloroethyl)-N-methyl-

**IUPAC name:** 2-Chloro-N-(2-chloroethyl)-N-methylethanamine

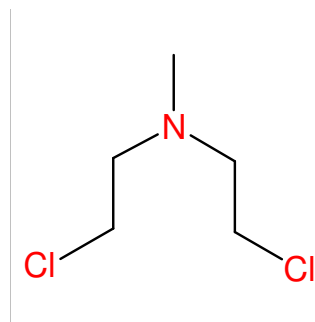

Synonyms: Methylbis(2-chloroethyl)amine  
Bis(β-chloroethyl)methylamine  
Chlorethazine  
Chlormethine  
Cloramin  
Di(2-chloroethyl)methylamine  
Diethylamine, 2,2'-dichloro-N-methyl-  
HN2  
HN2 (amine)  
2,2'-Dichloro-N-methyldiethylamine  
Mechlorethamine  
N-Methylbis(β-chloroethyl)amine  
Methylbis(β-chloroethyl)amine  
Methyldi(2-chloroethyl)amine  
Mustargen  
Mustine  
N,N-Bis(2-chloroethyl)-N-methylamine  
N,N-Bis(2-chloroethyl)methylamine  
N,N-Di(chloroethyl)methylamine  
N-Methyl-2,2'-dichlorodiethylamine  
N-Methylbis(2-chloroethyl)amine  
MBA

**Chemical name:** Bis(2-chloroethyl)ethylamine

Schedule: 1A06

CAS RN: 538-07-8

HS code: 2921.19

Key: 538-07-8

Molecular formula: C<sub>6</sub>H<sub>13</sub>Cl<sub>2</sub>N

CAS Index Name: Ethanamine, 2-chloro-N-(2-chloroethyl)-N-ethyl-

**IUPAC name:** 2-Chloro-N-(2-chloroethyl)-N-ethylethanamine

Synonyms: Triethylamine, 2,2'-dichloro-  
N-Ethylbis(2-chloroethyl)amine  
N,N-Bis(2-chloroethyl)-N-ethylamine  
HN1  
Ethylbis(2-chloroethyl)amine

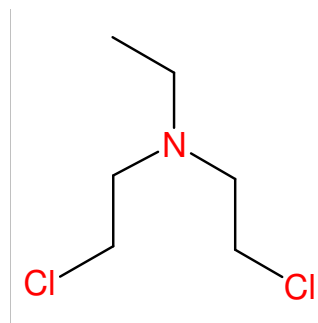

**Chemical name:** Tris(2-chloroethyl)amine

Schedule: 1A06

CAS RN: 555-77-1

HS code: 2921.19

Key: 555-77-1

Molecular formula: C<sub>6</sub>H<sub>12</sub>Cl<sub>3</sub>N

CAS Index Name: Ethanamine, 2-chloro-N,N-bis(2-chloroethyl)-

**IUPAC name:** 2-Chloro-N,N-bis(2-chloroethyl)ethanamine

Synonyms: TS 160  
Tris(β-chloroethyl)amine  
Triethylamine, 2,2',2''-trichloro-  
Trichlormethine  
Tri-2-chloroethylamine  
Nitrogen mustard  
N,N,N-Tris(2-chloroethyl)amine  
HN3  
2,2',2''-Trichlorotriethylamine

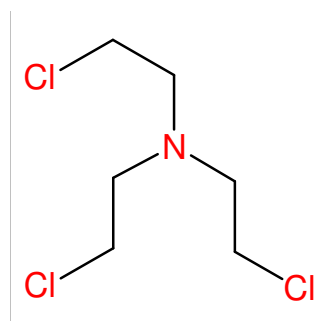

**Chemical name:** Saxitoxin [11-3H]

Schedule: 1A07

CAS RN:

HS code:

Key: (35523-89-8)-[11-3H]

Molecular formula: C<sub>10</sub>H<sub>14</sub>T<sub>3</sub>N<sub>7</sub>O<sub>4</sub>

CAS Index Name:

**IUPAC name:**

Synonyms:

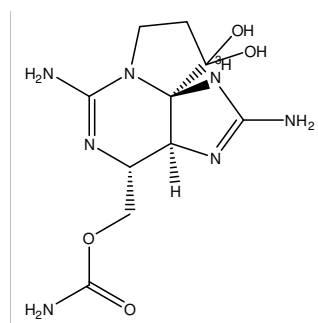

**Chemical name:** Saxitoxin

Schedule: 1A07

CAS RN: 35523-89-8

HS code: 3002.90

Key: 35523-89-8

Molecular formula: C<sub>10</sub>H<sub>17</sub>N<sub>7</sub>O<sub>4</sub>

CAS Index Name: 1H,10H-Pyrrolo[1,2-c]purine-10,10-diol, 2,6-diamino-4-[[[(aminocarbonyl)oxy]methyl]-3a,4,8,9-tetrahydro-, (3aS,4R,10aS)-

**IUPAC name:** [(4R)-10,10-dihydroxy-2,6-diiminoctahydro-1H,8H-pyrrolo[1,2-c]purin-4-yl]methyl carbamate

Synonyms: STX

Saxitoxin hydrate

Saxitoxin

(+)-Saxitoxin

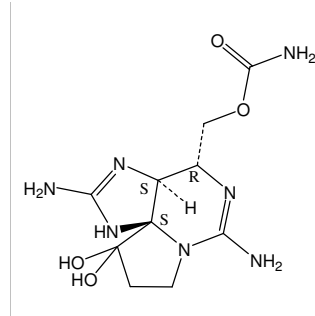

**Chemical name:** Ricin

Schedule: 1A08

CAS RN: 9009-86-3

HS code: 3002.90

Key: 9009-86-3

Molecular formula: Unspecified

CAS Index Name: Ricin

**IUPAC name:**

Synonyms: Ricins

Ricine

Proteins, specific or class, ricins

Proteins, ricins

STRUCTURE  
DIAGRAM  
IS NOT AVAILABLE

**Chemical name:** Methyl-[14C]-phosphonic difluoride

Schedule: 1B09

CAS RN: 103596-72-1

HS code: 2845.90

Key: 103596-72-1

Molecular formula: 14C H<sub>3</sub>F<sub>2</sub>OP

CAS Index Name: Phosphonic difluoride, methyl-14C-

**IUPAC name:** (14C)Methylphosphonic difluoride

Synonyms: [14C]Methylphosphonic difluoride

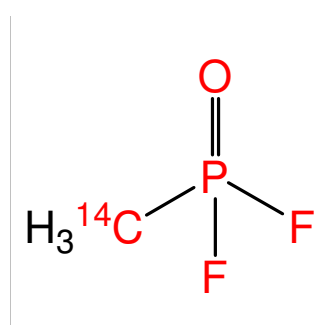

**Chemical name:** Methylphosphonic difluoride

Schedule: 1B09

CAS RN: 676-99-3

HS code: 2931.39

Key: 676-99-3

Molecular formula: CH<sub>3</sub>F<sub>2</sub>OP

CAS Index Name: Phosphonic difluoride, methyl-

**IUPAC name:** Methylphosphonic difluoride

Synonyms: Methylphosphonyldifluoride

Methyl difluorophosphite

Difluoromethylphosphine oxide

DF

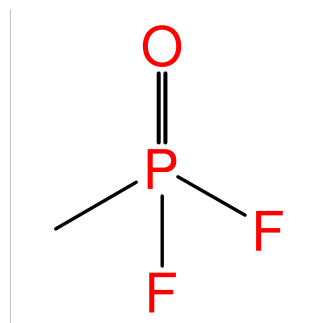

**Chemical name:** Isopropylphosphonic difluoride

Schedule: 1B09

CAS RN: 677-42-9

HS code: 2931.39

Key: 677-42-9

Molecular formula: C<sub>3</sub>H<sub>7</sub>F<sub>2</sub>OP

CAS Index Name: Phosphonic difluoride, (1-methylethyl)-

**IUPAC name:** Isopropylphosphonic difluoride

Synonyms: Isopropylphosphonyldifluoride

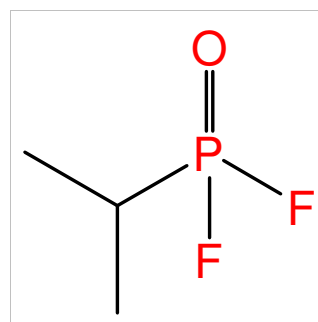

**Chemical name:** Propylphosphonic difluoride

Schedule: 1B09

CAS RN: 690-14-2

HS code: 2931.39

Key: 690-14-2

Molecular formula: C<sub>3</sub>H<sub>7</sub>F<sub>2</sub>OP

CAS Index Name: Phosphonic difluoride, propyl-

**IUPAC name:** Propylphosphonic difluoride

Synonyms: Propylphosphonyldifluoride

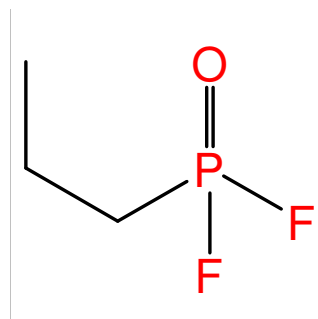

**Chemical name:** Ethylphosphonic difluoride

Schedule: 1B09

CAS RN: 753-98-0

HS code: 2931.39

Key: 753-98-0

Molecular formula: C<sub>2</sub>H<sub>5</sub>F<sub>2</sub>OP

CAS Index Name: Phosphonic difluoride, ethyl-

**IUPAC name:** Ethylphosphonic difluoride

Synonyms: Ethylphosphonyldifluoride

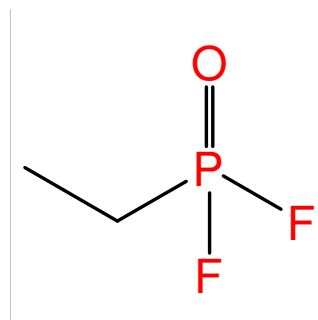

**Chemical name:** Mixture of Methylphosphonic difluoride and Methylphosphonic dichloride

Schedule: 1B09

CAS RN: 97505-35-6

HS code:

Key: 97505-35-6

Molecular formula: CH<sub>3</sub>Cl<sub>2</sub>OP.CH<sub>3</sub>F<sub>2</sub>OP

CAS Index Name: Phosphonic difluoride, methyl-, mixt. with methylphosphonic dichloride

**IUPAC name:**

Synonyms: Mixture: 50% Methylphosphonyldifluoride/50% Methylphosphonyldichloride

Mixture of 676-99-3, 676-97-1

Methylphosphonic dichloride difluoride

Di-Di

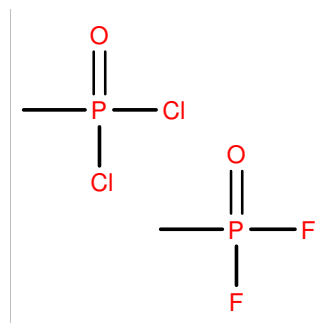

**Chemical name:** Ethyl 2-diisopropylaminoethyl ethylphosphonite

Schedule: 1B10

CAS RN:

HS code: 2931.39

Key: (64-17-5)-E1B10-II

Molecular formula: C<sub>12</sub>H<sub>28</sub>NO<sub>2</sub>P

CAS Index Name: Phosphonous acid, ethyl-, 2-[bis(1-methylethyl)amino]ethyl ethyl ester

**IUPAC name:** 2-(Diisopropylamino)ethyl ethyl ethylphosphonite

Synonyms: O-Ethyl O-2-diisopropylaminoethyl ethylphosphonite

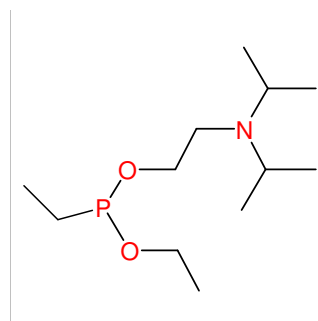

**Chemical name:** Ethyl 2-dimethylaminoethyl methylphosphonite

Schedule: 1B10

CAS RN:

HS code: 2931.39

Key: (64-17-5)-M1B10-MM

Molecular formula: C<sub>7</sub>H<sub>18</sub>NO<sub>2</sub>P

CAS Index Name: Phosphonous acid, methyl-, 2-(diethylamino)ethyl methyl ester

**IUPAC name:** 2-(Dimethylamino)ethyl ethyl methylphosphonite

Synonyms: O-Ethyl O-2-dimethylaminoethyl methylphosphonite

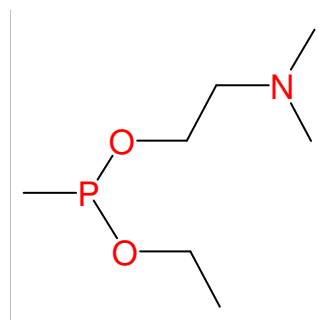



**Chemical name:** Ethyl 2-dipropylaminoethyl methylphosphonite

Schedule: 1B10

CAS RN: HS code: 2931.39

Key: (64-17-5)-M1B10-PP

Molecular formula: C<sub>11</sub>H<sub>26</sub>NO<sub>2</sub>P

CAS Index Name: Phosphonous acid, methyl-, 2-(dipropylamino)ethyl ethyl ester

**IUPAC name:** 2-(Dipropylamino)ethyl ethyl methylphosphonite

Synonyms: O-Ethyl O-2-dipropylaminoethyl methylphosphonite

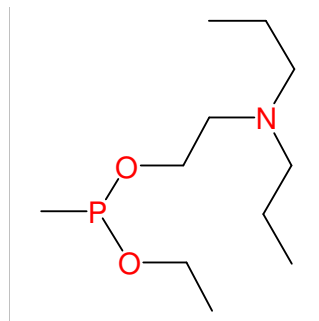

**Chemical name:** Cyclopentyl 2-diisopropylaminoethyl methylphosphonite

Schedule: 1B10

CAS RN: 1282026-51-0 HS code: 2931.39

Key: 1282026-51-0

Molecular formula: C<sub>14</sub>H<sub>30</sub>NO<sub>2</sub>P

CAS Index Name: Phosphonous acid, methyl-, 2-[bis(1-methylethyl)amino]ethyl cyclopentyl ester

**IUPAC name:** 2-(Diisopropylamino)ethyl cyclopentyl methylphosphonite

Synonyms: O-Cyclopentyl O-2-diisopropylaminoethyl methylphosphonite

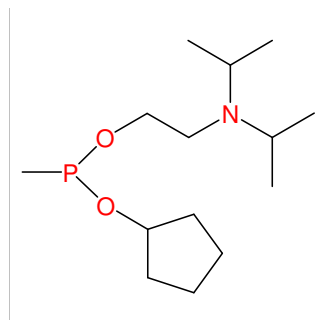

**Chemical name:** Butyl 2-diethylaminoethyl methylphosphonite

Schedule: 1B10

CAS RN: 169662-68-4 HS code: 2931.39

Key: 169662-68-4

Molecular formula: C<sub>11</sub>H<sub>26</sub>NO<sub>2</sub>P

CAS Index Name: Phosphonous acid, methyl-, 2-(diethylamino)ethyl butyl ester

**IUPAC name:**

Synonyms:

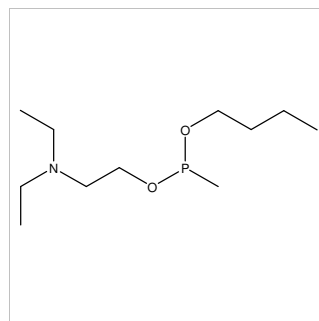

**Chemical name:** Ethyl 2-diethylaminoethyl methylphosphonite

Schedule: 1B10

CAS RN: 55523-55-2 HS code: 2931.39

Key: 55523-55-2

Molecular formula: C<sub>9</sub>H<sub>22</sub>NO<sub>2</sub>P

CAS Index Name: Phosphonous acid, methyl-, 2-(diethylamino)ethyl ethyl ester

**IUPAC name:** 2-(Diethylamino)ethyl ethyl methylphosphonite

Synonyms: O-Ethyl O-2-diethylaminoethyl methylphosphonite

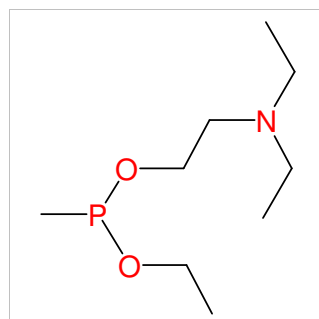

**Chemical name:** Ethyl 2-diisopropylaminoethyl methylphosphonite

Schedule: 1B10

CAS RN: 57856-11-8

HS code: 2931.39

Key: 57856-11-8

Molecular formula: C<sub>11</sub>H<sub>26</sub>NO<sub>2</sub>P

CAS Index Name: Phosphonous acid, methyl-, 2-[bis(1-methylethyl)amino]ethyl ethyl ester

**IUPAC name:** 2-(Diisopropylamino)ethyl ethyl methylphosphonite

Synonyms: QL

O-Ethyl O-2-diisopropylaminoethyl methylphosphonite

O-Ethyl 2-diisopropylaminoethyl methylphosphonite

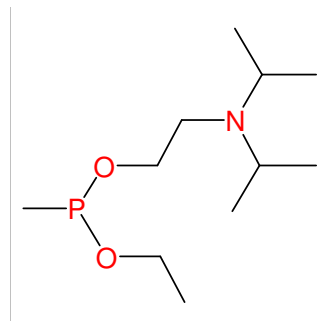

**Chemical name:** O-Isopropyl methyl-d<sub>3</sub>-phosphonochloridate

Schedule: 1B11

CAS RN:

HS code: 2845.90

Key: (1445-76-7)-D3

Molecular formula: C<sub>4</sub>H<sub>7</sub>D<sub>3</sub>ClO<sub>2</sub>P

CAS Index Name:

**IUPAC name:**

Synonyms: Isopropyl methyl-d<sub>3</sub>-phosphonochloridate

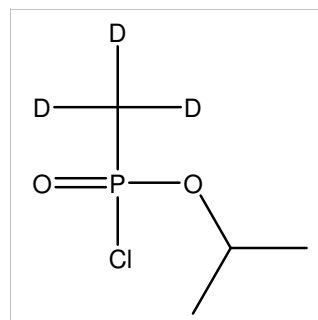

**Chemical name:** Isopropyl methylphosphonochloridate

Schedule: 1B11

CAS RN: 1445-76-7

HS code: 2931.39

Key: 1445-76-7

Molecular formula: C<sub>4</sub>H<sub>10</sub>ClO<sub>2</sub>P

CAS Index Name: Phosphonochloridic acid, methyl-, 1-methylethyl ester

**IUPAC name:** Isopropyl methylphosphonochloridoate

Synonyms: Phosphonochloridic acid, methyl-, isopropyl ester

O-Isopropyl methylphosphonochloridate

Isopropyl chloromethylphosphinate

Chlorosarin

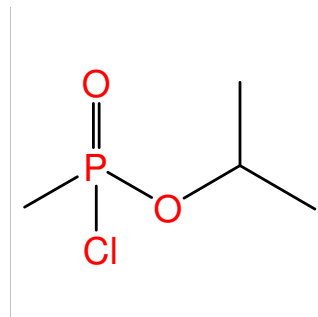

**Chemical name:** Pinacolyl methylphosphonochloridate

Schedule: 1B12

CAS RN: 7040-57-5

HS code: 2931.39

Key: 7040-57-5

Molecular formula: C<sub>7</sub>H<sub>16</sub>ClO<sub>2</sub>P

CAS Index Name: Phosphonochloridic acid, methyl-, 1,2,2-trimethylpropyl ester

**IUPAC name:** 1,2,2-Trimethylpropyl methylphosphonochloridoate

Synonyms: O-Pinacolyl methylphosphonochloridate

Chlorosoman

3,3-Dimethylbutan-2-yl methylphosphonochloridate

3,3-Dimethylbut-2-yl methylphosphonochloridate

2-Butanol, 3,3-dimethyl-, methylphosphonochloridate

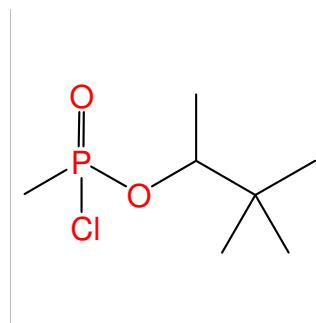

**Chemical name:** O,O-Diethyl S-2-diethylaminoethyl phosphorothiolate iodoethane

Schedule: 2A01

CAS RN:

HS code: 2930.90

Key: (78-53-5)-(75-03-6)

Molecular formula: C<sub>12</sub>H<sub>29</sub>INO<sub>3</sub>PS

CAS Index Name:

**IUPAC name:**

Synonyms:

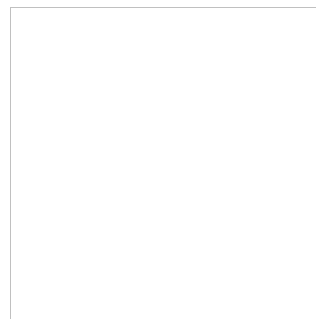

**Chemical name:** O,O-Diethyl S-2-diethylaminoethyl phosphorothiolate

Schedule: 2A01

CAS RN: 78-53-5

HS code: 2930.90

Key: 78-53-5

Molecular formula: C<sub>10</sub>H<sub>24</sub>NO<sub>3</sub>PS

CAS Index Name: Phosphorothioic acid, S-[2-(diethylamino)ethyl] O,O-diethyl ester

**IUPAC name:** O,O-Diethyl S-2-diethylaminoethyl phosphorothioate

Synonyms: S-[2-(diethylamino)ethyl] O,O-diethyl thiophosphate

S-(Diethylaminoethyl) O,O-diethyl phosphorothioate

R 5158

O,O-Diethyl S-2-diethylaminoethyl phosphorothiolate

O,O-Diethyl S-[2-(diethylamino)ethyl]phosphorothiolate

Metramac

Inferno

DSDP

Amiton

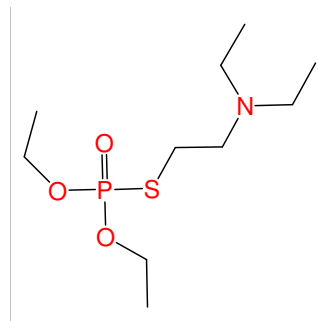

**Chemical name:** 1,1,3,3,3-Pentafluoro-2-(trifluoromethyl)-1-propene

Schedule: 2A02

CAS RN: 382-21-8

HS code: 2903.39

Key: 382-21-8

Molecular formula: C<sub>4</sub>F<sub>8</sub>

CAS Index Name: 1-Propene, 1,1,3,3,3-pentafluoro-2-(trifluoromethyl)-

**IUPAC name:** 1,1,3,3,3-Pentafluoro-2-(trifluoromethyl)prop-1-ene

Synonyms: Propene, pentafluoro-2-(trifluoromethyl)-

PFIB

Perfluoroisobutylene

Perfluoroisobutene

Perfluoro-2-methylpropene

Perfluoro-2-(trifluoromethyl)propene

Octafluoroisobutylene

Octafluoroisobutene

1,1-Difluoro-2,2-bis(trifluoromethyl)ethene

1,1,3,3,3-Pentafluoro-2-(trifluoromethyl)propene

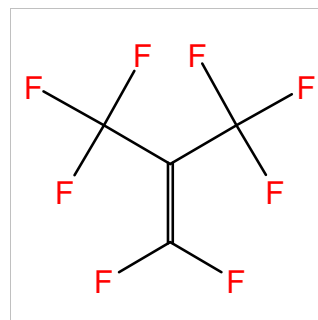

**Chemical name:** (S)-3-Quinuclidinyl benzilate

Schedule: 2A03

CAS RN: 62869-68-5

HS code: 2933.39

Key: 62869-68-5

Molecular formula: C<sub>21</sub>H<sub>23</sub>NO<sub>3</sub>

CAS Index Name: Benzeneacetic acid, a-hydroxy-à-phenyl-, (3S)-1-azabicyclo[2.2.2]oct-3-yl ester

**IUPAC name:** (S)-1-Azabicyclo[2.2.2]oct-3-yl hydroxy(diphenyl)acetate

Synonyms: Benzeneacetic acid, a-hydroxy-a-phenyl-, 1-azabicyclo[2.2.2]oct-3-yl ester, (S)-

(S)-QNB

(S)-BZ

(L)-Quinuclidinyl benzilate

(+)-3-Quinuclidinyl benzilate

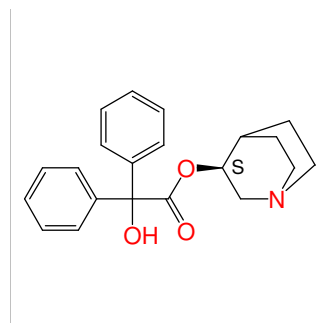

**Chemical name:** (R)-3-Quinuclidinyl benzilate

Schedule: 2A03

CAS RN: 62869-69-6

HS code: 2933.39

Key: 62869-69-6

Molecular formula: C<sub>21</sub>H<sub>23</sub>NO<sub>3</sub>

CAS Index Name: Benzeneacetic acid, a-hydroxy-à-phenyl-, (3R)-1-azabicyclo[2.2.2]oct-3-yl ester

**IUPAC name:** (R)-1-Azabicyclo[2.2.2]oct-3-yl hydroxy(diphenyl)acetate

Synonyms: Benzeneacetic acid, a-hydroxy-a-phenyl-, 1-azabicyclo[2.2.2]oct-3-yl ester, (R)-

(R)-QNB

(R)-BZ

(D)-Quinuclidinyl benzilate

(-)-3-Quinuclidinyl benzilate

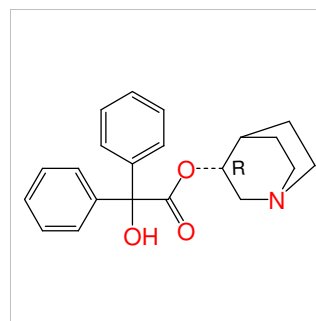

**Chemical name:** 3-Quinuclidinyl benzilate

Schedule: 2A03

CAS RN: 6581-06-2

HS code: 2933.39

Key: 6581-06-2

Molecular formula: C<sub>21</sub>H<sub>23</sub>NO<sub>3</sub>

CAS Index Name: Benzeneacetic acid, α-hydroxy-à-phenyl-, 1-azabicyclo[2.2.2]oct-3-yl ester

**IUPAC name:** 1-Azabicyclo[2.2.2]oct-3-yl hydroxy(diphenyl)acetate

Synonyms: β-Quinuclidinyl benzilate

Ro 2-3308

QNB

BZ

Benzilic acid, 3-quinuclidinyl ester

3-Quinuclidinol, benzilate (ester)

3-Quinuclidinol benzilate

3-Oxyquinuclidine benzilate

3-Hydroxyquinuclidine benzilate

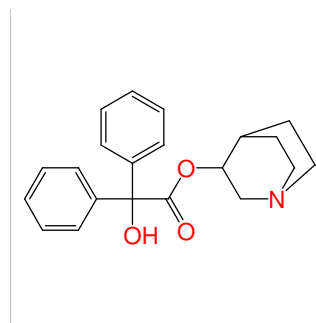

**Chemical name:** Cyclohexylmethyl S-sodium isopropylphosphonothiolate

Schedule: 2B04

CAS RN:

HS code: 2930.90

Key: (100-49-2)-I2B41-S(Na)

Molecular formula: C<sub>10</sub>H<sub>20</sub>NaO<sub>2</sub>PS

CAS Index Name: Phosphonothioic acid, 1-methylethyl-, O-(cyclohexylmethyl) ester sodium salt

**IUPAC name:** Sodium O-cyclohexylmethyl isopropylphosphonothioate

Synonyms: Sodium O-(cyclohexylmethyl) isopropylphosphonothiolate

O-Cyclohexylmethyl S-sodium isopropylphosphonothiolate

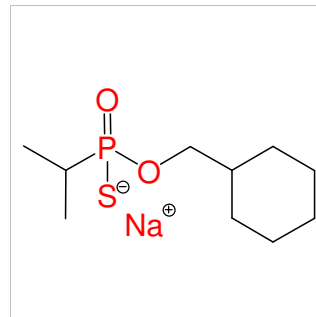

**Chemical name:** Cyclohexylmethyl S-sodium propylphosphonothiolate

Schedule: 2B04

CAS RN:

HS code: 2930.90

Key: (100-49-2)-P2B41-S(Na)

Molecular formula: C<sub>10</sub>H<sub>20</sub>NaO<sub>2</sub>PS

CAS Index Name: Phosphonothioic acid, propyl-, O-(cyclohexylmethyl) ester, sodium salt

**IUPAC name:** Sodium O-cyclohexylmethyl propylphosphonothioate

Synonyms: Sodium O-cyclohexylmethyl propylphosphonothiolate

O-Cyclohexylmethyl S-sodium propylphosphonothiolate

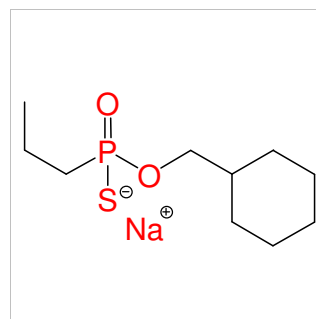

**Chemical name:** Benzyl methylphosphonate

Schedule: 2B04

CAS RN: HS code: 2931.39

Key: (100-51-6)-M2B41

Molecular formula: C<sub>8</sub>H<sub>11</sub>O<sub>3</sub>P

CAS Index Name: Phosphonic acid, methyl-, monobenzyl ester

**IUPAC name:** Benzyl methylphosphonate

Synonyms:

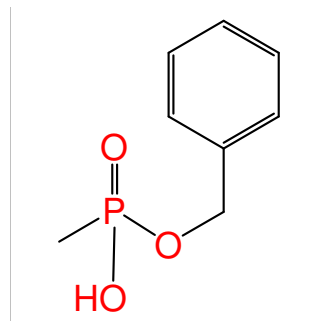

**Chemical name:** Mixture of Dimethyldiphosphonic acid (CAS RN 1070-90-2) and Methyl methylphosphonate (CAS RN 1066-53-1)

Schedule: 2B04

CAS RN: HS code: 3824.90

Key: (1070-90-2)-(1066-53-1)

Molecular formula: C<sub>4</sub>H<sub>15</sub>O<sub>8</sub>P<sub>3</sub>

CAS Index Name:

**IUPAC name:**

Synonyms:

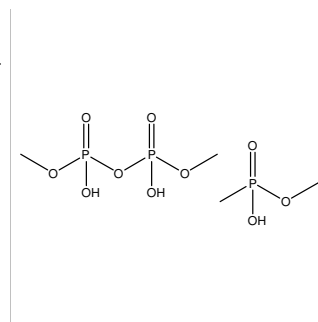

**Chemical name:** 1,3-Dimethylbutyl pinacolyl methylphosphonate

Schedule: 2B04

CAS RN: HS code: 2931.39

Key: (108-11-2)-M2B41-(464-07-3)

Molecular formula: C<sub>13</sub>H<sub>29</sub>O<sub>3</sub>P

CAS Index Name: Phosphonic acid, methyl-, 1,3-dimethylbutyl 1,2,2-trimethylpropyl ester

**IUPAC name:** 1,3-Dimethylbutyl 1,2,2-trimethylpropyl methylphosphonate

Synonyms: O-(1,3-Dimethylbutyl) O-(1,2,2-trimethylpropyl) methylphosphonate

4-Methylpentan-2-yl pinacolyl methylphosphonate

4-Methylpentan-2-yl 3,3-dimethylbutan-2-yl methylphosphonate

4-Methylpentan-2-yl 1,2,2-trimethylpropyl methylphosphonate

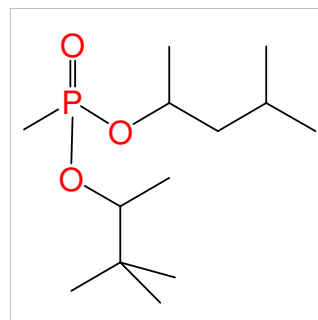

**Chemical name:** Cyclohexyl ethyl ethylphosphonate

Schedule: 2B04

CAS RN: HS code: 2931.39

Key: (108-93-0)-E2B41-(64-17-5)

Molecular formula: C<sub>10</sub>H<sub>21</sub>O<sub>3</sub>P

CAS Index Name: Phosphonic acid, ethyl-, cyclohexyl ethyl ester

**IUPAC name:** Cyclohexyl ethyl ethylphosphonate

Synonyms: O-Cyclohexyl O-ethyl ethylphosphonate

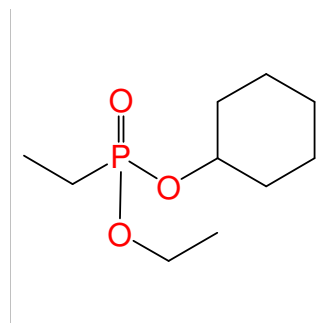

**Chemical name:** Cyclohexyl methyl isopropylphosphonate

Schedule: 2B04

CAS RN: HS code: 2931.39

Key: (108-93-0)-I2B41-(67-56-1)

Molecular formula: C<sub>10</sub>H<sub>21</sub>O<sub>3</sub>P

CAS Index Name: Phosphonic acid, 1-methylethyl-, cyclohexyl methyl ester

**IUPAC name:**

Synonyms:

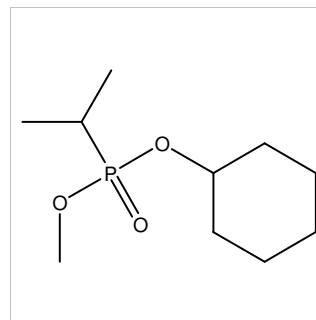

**Chemical name:** O-Cyclohexyl isopropylphosphonothiolate

Schedule: 2B04

CAS RN: HS code: 2930.90

Key: (108-93-0)-I2B41-SH

Molecular formula: C<sub>9</sub>H<sub>19</sub>O<sub>2</sub>PS

CAS Index Name:

**IUPAC name:**

Synonyms:

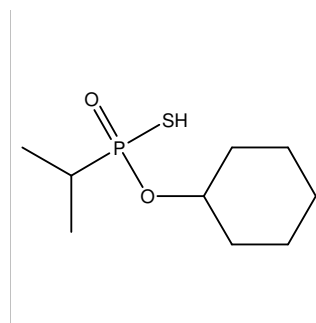

**Chemical name:** Cyclohexyl pinacolyl methylphosphonate

Schedule: 2B04

CAS RN: HS code: 2931.39

Key: (108-93-0)-M2B41-(464-07-3)

Molecular formula: C<sub>13</sub>H<sub>27</sub>O<sub>3</sub>P

CAS Index Name: Phosphonic acid, methyl-, cyclohexyl 1,2,2-trimethylpropyl ester

**IUPAC name:** Cyclohexyl 1,2,2-trimethylpropyl methylphosphonate

Synonyms: O-Cyclohexyl O-(3,3-dimethylbutan-2-yl) methylphosphonate

O-Cyclohexyl O-(1,2,2-trimethylpropyl) methylphosphonate

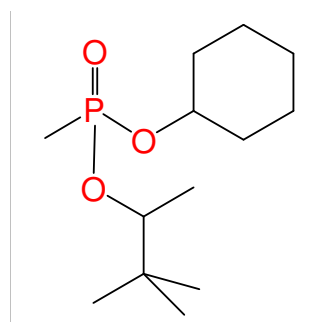



**Chemical name:** Cyclohexyl N-methyl-N-(2-hydroxyethyl) methylphosphonoamidate

Schedule: 2B04

CAS RN: HS code: 2931.39

Key: (108-93-0)-M2B41-N(65-56-1)(107-21-1)

Molecular formula: C<sub>10</sub>H<sub>22</sub>NO<sub>3</sub>P

CAS Index Name:

**IUPAC name:** Cyclohexyl N-(2-hydroxyethyl)-N,P-dimethylphosphonamidoate

Synonyms:

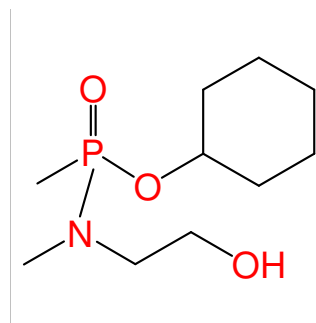

**Chemical name:** Cyclohexyl methylphosphinate

Schedule: 2B04

CAS RN: HS code: 2931.39

Key: (108-93-0)-M2B42

Molecular formula: C<sub>7</sub>H<sub>15</sub>O<sub>2</sub>P

CAS Index Name: Phosphinic acid, methyl-, cyclohexyl ester

**IUPAC name:** Cyclohexyl methylphosphinate

Synonyms:

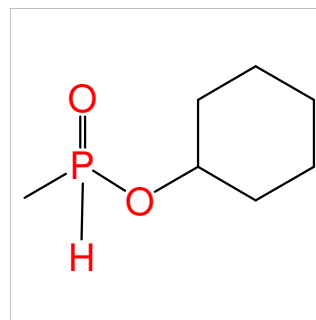

**Chemical name:** O-Hexyl O-2-methoxyethyl isopropylphosphonate

Schedule: 2B04

CAS RN: HS code: 2931.39

Key: (109-86-4)-I2B41-(111-27-3)

Molecular formula: C<sub>12</sub>H<sub>27</sub>O<sub>4</sub>P

CAS Index Name:

**IUPAC name:**

Synonyms:

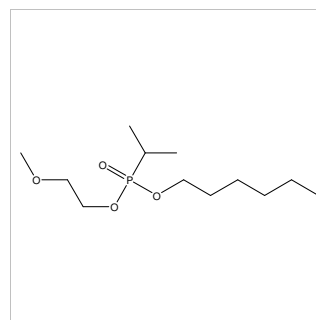

**Chemical name:** O-2-Methoxyethyl O-4-methylpentyl isopropylphosphonate

Schedule: 2B04

CAS RN: HS code: 2931.39

Key: (109-86-4)-I2B41-(626-89-1)

Molecular formula: C<sub>12</sub>H<sub>27</sub>O<sub>4</sub>P

CAS Index Name:

**IUPAC name:**

Synonyms:

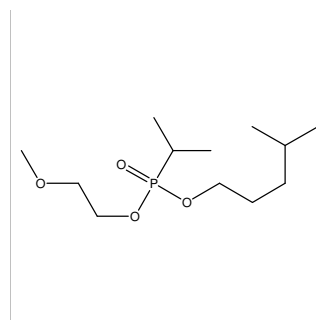

**Chemical name:** O-Hexyl O-2-methoxyethyl propylphosphonate

Schedule: 2B04

CAS RN: HS code: 2931.39

Key: (109-86-4)-P2B41-(111-27-3)

Molecular formula: C<sub>12</sub>H<sub>27</sub>O<sub>4</sub>P

CAS Index Name:

**IUPAC name:**

Synonyms:

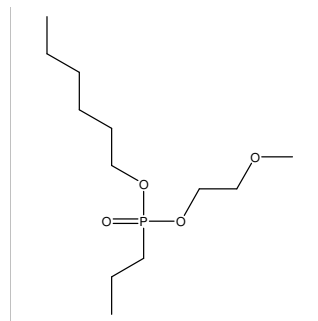

**Chemical name:** O-2-Methoxyethyl O-4-methylpentyl propylphosphonate

Schedule: 2B04

CAS RN: HS code: 2931.39

Key: (109-86-4)-P2B41-(626-89-1)

Molecular formula: C<sub>12</sub>H<sub>27</sub>O<sub>4</sub>P

CAS Index Name:

**IUPAC name:**

Synonyms:

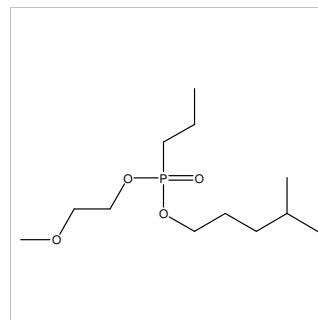

**Chemical name:** O-Hexyl methylphosphonothionate

Schedule: 2B04

CAS RN: HS code: 2930.90

Key: (111-27-3)-M2B45

Molecular formula: C<sub>7</sub>H<sub>17</sub>O<sub>2</sub>PS

CAS Index Name: Phosphonothioic acid, methyl-, O-hexyl ester

**IUPAC name:** O-Hexyl methylphosphonothioate

Synonyms:

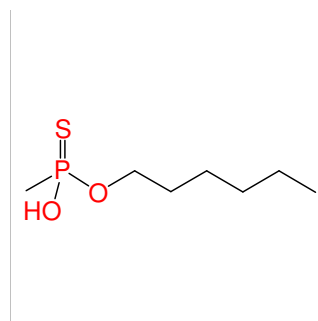

**Chemical name:** O,O-Dihexyl methylphosphonothionate

Schedule: 2B04

CAS RN: HS code: 2930.90

Key: (111-27-3)-M2B45-(111-27-3)

Molecular formula: C<sub>13</sub>H<sub>29</sub>O<sub>2</sub>PS

CAS Index Name: Phosphonothioic acid, methyl-, O,O-dihexyl ester

**IUPAC name:** O,O-Dihexyl methylphosphonothioate

Synonyms: Dihexyl methylphosphonothionate

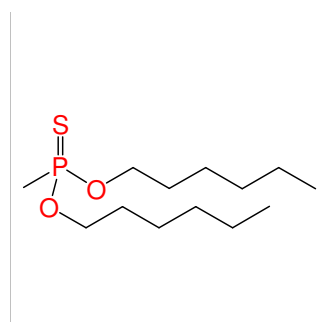

**Chemical name:** Heptyl S-sodium isopropylphosphonothiolate

Schedule: 2B04

CAS RN: HS code: 2930.90

Key: (111-70-6)-I2B41-S(Na)

Molecular formula: C<sub>10</sub>H<sub>22</sub>NaO<sub>2</sub>PS

CAS Index Name: Phosphonothioic acid, 1-methylethyl-, O-heptyl ester sodium salt

**IUPAC name:** Sodium O-heptyl isopropylphosphonothioate

Synonyms: O-Heptyl S-sodium isopropylphosphonothiolate

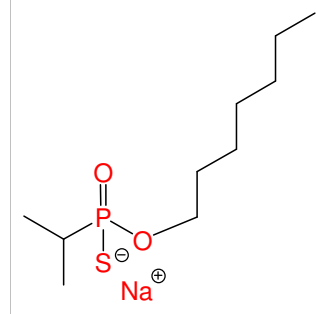

**Chemical name:** O-Heptyl methylphosphonothionate

Schedule: 2B04

CAS RN: HS code: 2930.90

Key: (111-70-6)-M2B45

Molecular formula: C<sub>8</sub>H<sub>19</sub>O<sub>2</sub>PS

CAS Index Name: Phosphonothioic acid, methyl-, O-heptyl ester

**IUPAC name:** O-Heptyl methylphosphonothioate

Synonyms:

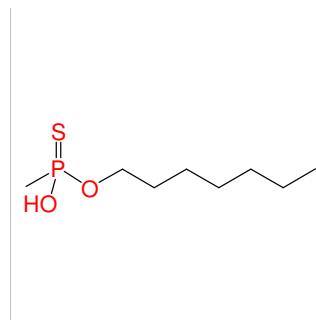

**Chemical name:** O,O-Diheptyl methylphosphonothionate

Schedule: 2B04

CAS RN: HS code: 2930.90

Key: (111-70-6)-M2B45-(111-70-6)

Molecular formula: C<sub>15</sub>H<sub>33</sub>O<sub>2</sub>PS

CAS Index Name: Phosphonothioic acid, methyl-, O,O-diheptyl ester

**IUPAC name:** O,O-Diheptyl methylphosphonothioate

Synonyms: Diheptyl methylphosphonothionate

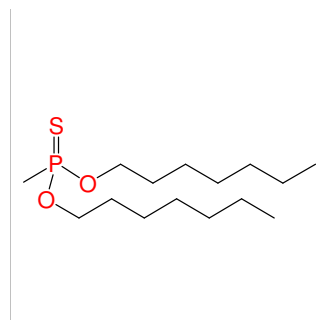

**Chemical name:** Octyl ethylphosphonate

Schedule: 2B04

CAS RN: HS code: 2931.39

Key: (111-87-5)-E2B41

Molecular formula: C<sub>10</sub>H<sub>23</sub>O<sub>3</sub>P

CAS Index Name: Phosphonic acid, ethyl-, mono-octyl ester

**IUPAC name:** Octyl ethylphosphonate

Synonyms: O-Octyl ethylphosphonate

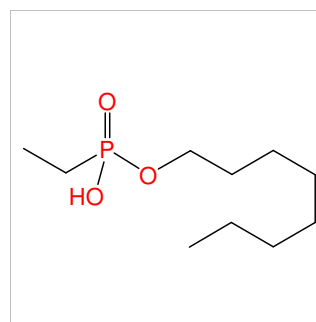

**Chemical name:** O-Octyl methylphosphonothiolate

Schedule: 2B04

CAS RN: HS code: 2930.90

Key: (111-87-5)-M2B41-SH

Molecular formula: C<sub>9</sub>H<sub>21</sub>O<sub>2</sub>PS

CAS Index Name:

**IUPAC name:**

Synonyms:

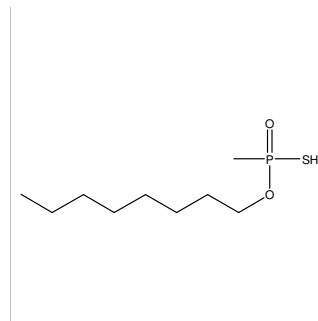

**Chemical name:** O-Octyl methylphosphonothionate

Schedule: 2B04

CAS RN: HS code: 2930.90

Key: (111-87-5)-M2B45

Molecular formula: C<sub>9</sub>H<sub>21</sub>O<sub>2</sub>PS

CAS Index Name: Phosphonothioic acid, methyl-, O-octyl ester

**IUPAC name:** O-Octyl methylphosphonothioate

Synonyms:

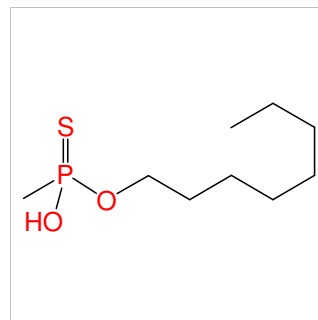

**Chemical name:** O,O-Dioctyl methylphosphonothionate

Schedule: 2B04

CAS RN: HS code: 2930.90

Key: (111-87-5)-M2B45-(111-87-5)

Molecular formula: C<sub>17</sub>H<sub>37</sub>O<sub>2</sub>PS

CAS Index Name: Phosphonothioic acid, methyl-, O,O-dioctyl ester

**IUPAC name:** O,O-Dioctyl methylphosphonothioate

Synonyms: Dioctyl methylphosphonothionate

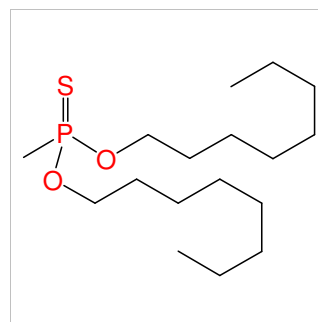

**Chemical name:** Octyl S-sodium propylphosphonothiolate

Schedule: 2B04

CAS RN: HS code: 2930.90

Key: (111-87-5)-P2B41-S(Na)

Molecular formula: C<sub>11</sub>H<sub>24</sub>NaO<sub>2</sub>PS

CAS Index Name: Phosphonothioic acid, propyl-, O-octyl ester, sodium salt

**IUPAC name:** Sodium O-octyl propylphosphonothioate

Synonyms:

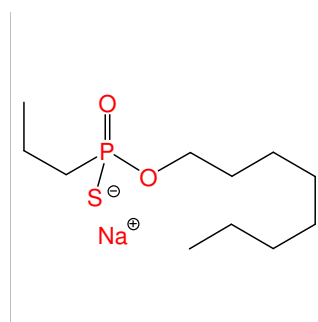

**Chemical name:** 1-Methylnonyl methylphosphonate

Schedule: 2B04

CAS RN: HS code: 2931.39

Key: (1120-06-2)-M2B41

Molecular formula: C<sub>11</sub>H<sub>25</sub>O<sub>3</sub>P

CAS Index Name: Phosphonic acid, methyl-, mono(1-methylnonyl) ester

**IUPAC name:** 1-Methylnonyl methylphosphonate

Synonyms: Decan-2-yl methylphosphonate

Dec-2-yl methylphosphonate

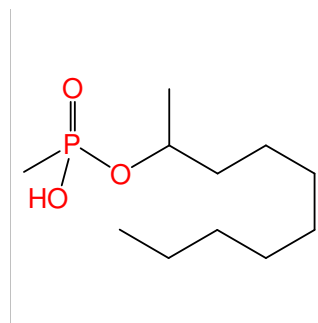

**Chemical name:** Bis(1-methylnonyl) methylphosphonate

Schedule: 2B04

CAS RN: HS code: 2931.39

Key: (1120-06-2)-M2B41-(1120-06-2)

Molecular formula: C<sub>21</sub>H<sub>45</sub>O<sub>3</sub>P

CAS Index Name: Phosphonic acid, methyl-, bis(1-methylnonyl) ester

**IUPAC name:** Bis(1-methylnonyl) methylphosphonate

Synonyms: Bis(decan-2-yl) methylphosphonate

Bis(dec-2-yl) methylphosphonate

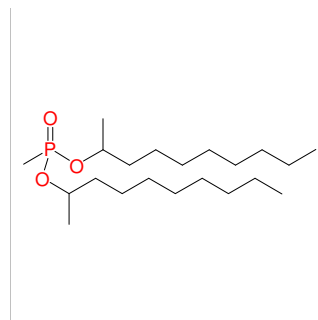

**Chemical name:** Decyl S-sodium methylphosphonothiolate

Schedule: 2B04

CAS RN: HS code: 2930.90

Key: (112-30-1)-M2B41-S(Na)

Molecular formula: C<sub>11</sub>H<sub>24</sub>NaO<sub>2</sub>PS

CAS Index Name: Phosphonothioic acid, methyl-, O-decyl ester, sodium salt

**IUPAC name:** Sodium O-decyl methylphosphonothioate

Synonyms:

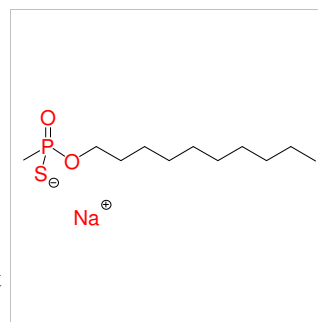

**Chemical name:** O-Decyl-O-sodium methylphosphonothionate

Schedule: 2B04

CAS RN: HS code: 2930.90

Key: (112-30-1)-M2B45-O(Na)

Molecular formula: C<sub>11</sub>H<sub>24</sub>NaO<sub>2</sub>PS

CAS Index Name: Phosphonothioic acid, methyl-, O-decyl ester sodium salt

**IUPAC name:** Sodium O-decyl methylphosphonothioate

Synonyms: Sodium O-decyl methylphosphonothionate

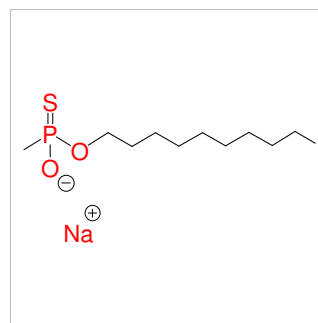

**Chemical name:** (Methoxy-1-methylethyl)ethyl methylphosphonate

Schedule: 2B04

CAS RN: HS code: 2931.39

Key: (127290-59-9)-M2B41

Molecular formula: C<sub>7</sub>H<sub>17</sub>O<sub>4</sub>P

CAS Index Name:

**IUPAC name:**

Synonyms:

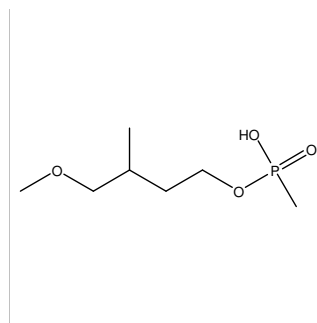

**Chemical name:** 2-tert-Butylcyclohexyl S-sodium isopropylphosphonothiolate

Schedule: 2B04

CAS RN: HS code: 2930.90

Key: (13491-79-7)-I2B41-S(Na)

Molecular formula: C<sub>13</sub>H<sub>26</sub>NaO<sub>2</sub>PS

CAS Index Name: Phosphonothioic acid, 1-methylethyl-, O-[2-(1,1-dimethylethyl)cyclohexyl] ester, sodium salt

**IUPAC name:** Sodium O-2-tert-Butylcyclohexyl isopropylphosphonothioate

Synonyms:

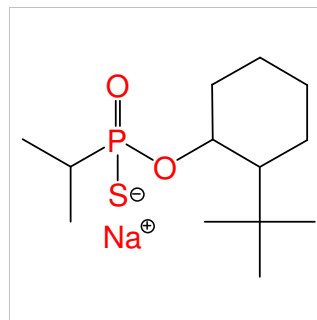

**Chemical name:** 2-tert-Butylcyclohexyl S-sodium propylphosphonothiolate

Schedule: 2B04

CAS RN: HS code: 2930.90

Key: (13491-79-7)-P2B41-S(Na)

Molecular formula: C<sub>13</sub>H<sub>26</sub>NaO<sub>2</sub>PS

CAS Index Name: Phosphonothioic acid, propyl-, O-[2-(1,1-dimethylethyl)cyclohexyl] ester, sodium salt

**IUPAC name:** Sodium O-2-tert-Butylcyclohexyl propylphosphonothioate

Synonyms:

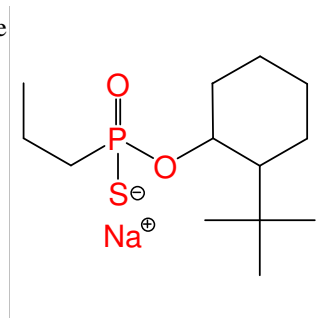

**Chemical name:** 2-Methylbutyl ethylphosphonate

Schedule: 2B04

CAS RN: HS code: 2931.39

Key: (137-32-6)-E2B41

Molecular formula: C<sub>7</sub>H<sub>17</sub>O<sub>3</sub>P

CAS Index Name:

**IUPAC name:**

Synonyms:

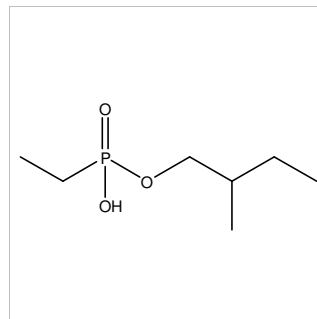

**Chemical name:** Sodium O-ethyl-d5 methylphosphonothiolate

Schedule: 2B04

CAS RN: HS code: 2845.90

Key: (1516-08-1)-M2B41-S(Na+)

Molecular formula: C3H3D5NaO2PS

CAS Index Name:

**IUPAC name:**

Synonyms:

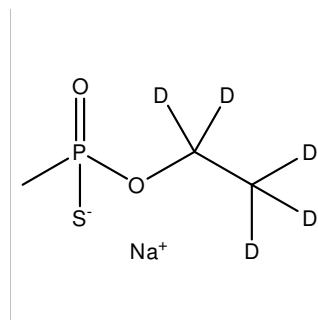

**Chemical name:** Bis(2,4,4-Trimethylpentyl) methylphosphonate

Schedule: 2B04

CAS RN: HS code: 2931.39

Key: (16325-63-6)-M2B41-(16325-63-6)

Molecular formula: C17H37O3P

CAS Index Name: Phosphonic acid, methyl-, bis(2,4,4-trimethylpentyl)ester

**IUPAC name:** Bis(2,4,4-Trimethylpentyl) methylphosphonate

Synonyms: O,O-bis(2,4,4-Trimethylpentyl) methylphosphonate

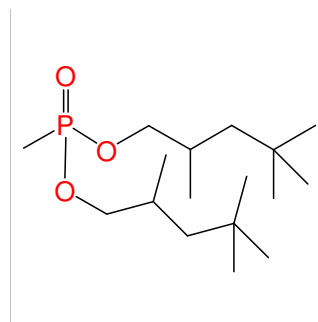

**Chemical name:** 2-Diethylaminoethyl 2-(methylpropylamino) ethyl phosphonate

Schedule: 2B04

CAS RN: HS code: 2931.39

Key: (2893-45-0)-E2B41-(100-37-8)

Molecular formula: C14H33N2O3P

CAS Index Name:

**IUPAC name:**

Synonyms:

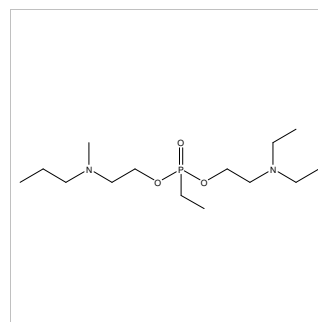

**Chemical name:** Bis[2-(methylpropylamino)ethyl] ethylphosphonate

Schedule: 2B04

CAS RN: HS code: 2931.39

Key: (2893-45-0)-E2B41-(2893-45-0)

Molecular formula: C14H33N2O3P

CAS Index Name:

**IUPAC name:**

Synonyms:

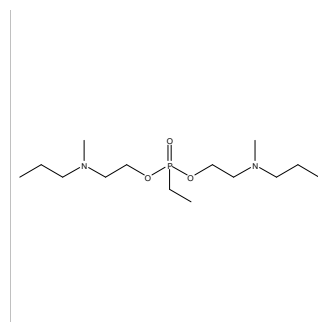

**Chemical name:** 2-Diethylaminoethyl 2-(ethylpropylamino) ethyl methylphosphonate

Schedule: 2B04

CAS RN: HS code: 2931.39

Key: (2893-56-3)-M2B41-(100-37-8)

Molecular formula: C<sub>14</sub>H<sub>33</sub>N<sub>2</sub>O<sub>3</sub>P

CAS Index Name:

**IUPAC name:**

Synonyms:

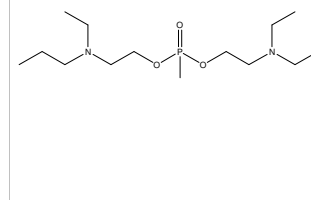

**Chemical name:** 3,5,5-Trimethylhexyl S-sodium propylphosphonothiolate

Schedule: 2B04

CAS RN: HS code: 2930.90

Key: (3452-97-9)-P2B41-S(Na)

Molecular formula: C<sub>12</sub>H<sub>26</sub>NaO<sub>2</sub>PS

CAS Index Name: Phosphonothioic acid, propyl-, O-(3,5,5-trimethylhexyl) ester, sodium salt

**IUPAC name:** Sodium O-(3,5,5-trimethylhexyl) propylphosphonothioate

Synonyms:

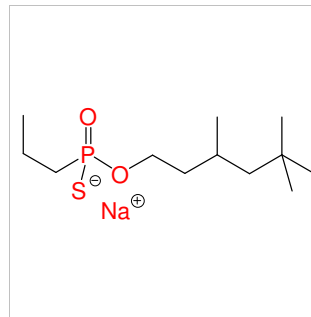

**Chemical name:** Pinacolyl S-sodium ethylphosphonothiolate

Schedule: 2B04

CAS RN: HS code: 2930.90

Key: (464-07-3)-E2B41-S(Na)

Molecular formula: C<sub>8</sub>H<sub>18</sub>NaO<sub>2</sub>PS

CAS Index Name: Phosphonothioic acid, ethyl-, O-1,2,2-trimethylpropyl ester, sodium salt

**IUPAC name:** Sodium O-(1,2,2-trimethylpropyl) ethylphosphonothioate

Synonyms: Phosphonothioic acid, ethyl-, O-3,3-dimethylbut-2-yl ester, sodium salt

3,3-Dimethylbutan-2-yl S-sodium ethylphosphonothiolate

3,3-Dimethylbut-2-yl S-sodium ethylphosphonothiolate

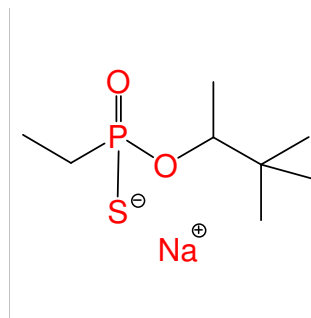

**Chemical name:** Dipinacolyl isopropylphosphonate

Schedule: 2B04

CAS RN: HS code: 2931.39

Key: (464-07-3)-I2B41-(464-07-3)

Molecular formula: C<sub>15</sub>H<sub>33</sub>O<sub>3</sub>P

CAS Index Name: Phosphonic acid, 1-methylethyl-, bis(1,2,2-trimethylpropyl) ester

**IUPAC name:** Bis(1,2,2-trimethylpropyl) isopropylphosphonate

Synonyms: O,O-Dipinacolyl isopropylphosphonate

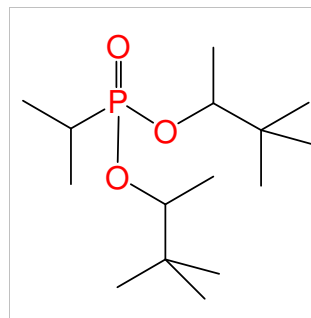



**Chemical name:** O-Pinacolyl isopropylphosphonothiolate sodium salt (1:1)

Schedule: 2B04

CAS RN: HS code: 2930.90

Key: (464-07-3)-I2B41-S(Na)

Molecular formula: C<sub>9</sub>H<sub>20</sub>NaO<sub>2</sub>PS

CAS Index Name:

**IUPAC name:**

Synonyms:

**Chemical name:** Pinacolyl N-methyl-N-(2-hydroxyethyl) methylphosphonamidate

Schedule: 2B04

CAS RN: HS code: 2931.39

Key: (464-07-3)-M2B41-N(65-56-1)(107-21-1)

Molecular formula: C<sub>10</sub>H<sub>24</sub>NO<sub>3</sub>P

CAS Index Name:

**IUPAC name:** 1,2,2-Trimethylpropyl N-(2-hydroxyethyl)-N,P-dimethylphosphonamidoate

Synonyms: 3,3-Dimethylbutan-2-yl N-(2-hydroxyethyl)-N,P-dimethylphosphonamidate

3,3-Dimethylbut-2-yl N-(2-hydroxyethyl)-N,P-dimethylphosphonamidate

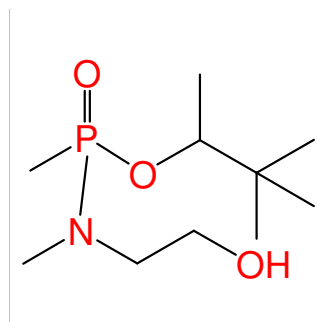

**Chemical name:** O-Pinacolylmethylthiophosphonofluoridate

Schedule: 2B04

CAS RN: HS code: 2930.90

Key: (464-07-3)-M2B45-F

Molecular formula: C<sub>7</sub>H<sub>16</sub>FOPS

CAS Index Name:

**IUPAC name:**

Synonyms:

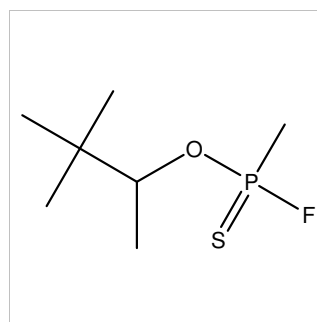

**Chemical name:** O-Pinacolyl propylphosphonothiolate

Schedule: 2B04

CAS RN: HS code: 2930.90

Key: (464-07-3)-P2B41-SH

Molecular formula: C<sub>9</sub>H<sub>21</sub>O<sub>2</sub>PS

CAS Index Name:

**IUPAC name:**

Synonyms:

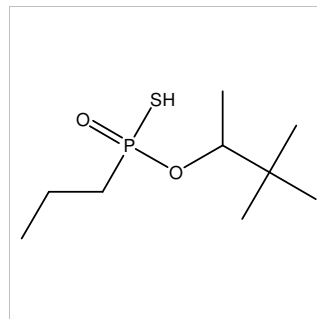

**Chemical name:** 2,6-Dimethylcyclohexyl S-sodium  
isopropylphosphonothiolate

Schedule: 2B04

CAS RN: HS code: 2930.90

Key: (5337-72-4)-I2B41-S(Na)

Molecular formula: C<sub>11</sub>H<sub>22</sub>NaO<sub>2</sub>PS

CAS Index Name: Phosphonothioic acid, 1-methylethyl-, O-(2,6-dimethylcyclohexyl) ester, sodium salt

**IUPAC name:** Sodium O-2,6-Dimethylcyclohexyl  
isopropylphosphonothioate

Synonyms:

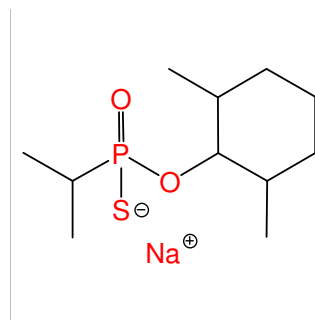

**Chemical name:** 1-Propyl-2-methoxyethyl methylphosphonate

Schedule: 2B04

CAS RN: HS code: 2931.39

Key: (53892-32-3)-M2B41

Molecular formula: C<sub>7</sub>H<sub>17</sub>O<sub>4</sub>P

CAS Index Name: Phosphonic acid, methyl-, monopropyl(2-methoxyethyl)  
ester

**IUPAC name:** 1-Methoxypentan-2-yl methylphosphonate

Synonyms:

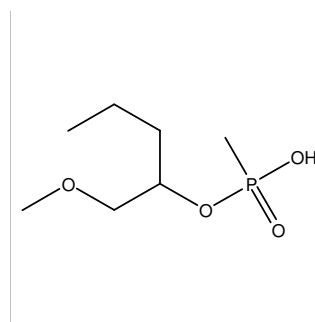

**Chemical name:** Benzyl methylphosphonochloridate-d<sub>3</sub>

Schedule: 2B04

CAS RN: HS code: 2845.90

Key: (543-49-7)-M(d<sub>3</sub>)2B41-Cl

Molecular formula: C<sub>8</sub>H<sub>7</sub>D<sub>3</sub>ClO<sub>2</sub>P

CAS Index Name:

**IUPAC name:**

Synonyms:

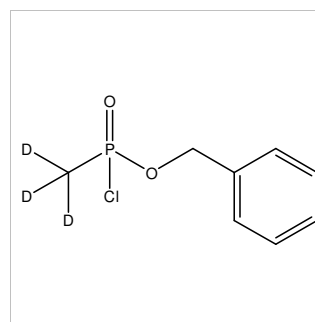

**Chemical name:** Benzyl P-methylphosphonoamidate-d<sub>3</sub>

Schedule: 2B04

CAS RN: HS code: 2845.90

Key: (543-49-7)-M(d<sub>3</sub>)2B41-N(H)(H)

Molecular formula: C<sub>8</sub>H<sub>9</sub>D<sub>3</sub>NO<sub>2</sub>P

CAS Index Name:

**IUPAC name:**

Synonyms:

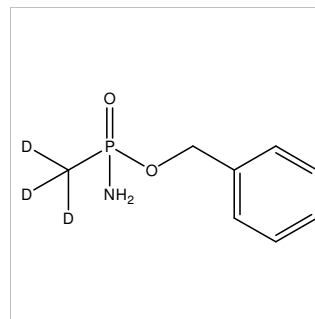

**Chemical name:** 1-Methylhexyl methylphosphonate

Schedule: 2B04

CAS RN: HS code: 2931.39

Key: (543-49-7)-M2B41

Molecular formula: C<sub>8</sub>H<sub>19</sub>O<sub>3</sub>P

CAS Index Name: Phosphonic acid, methyl-, mono(1-methylhexyl) ester

**IUPAC name:** 1-Methylhexyl methylphosphonate

Synonyms: Heptan-2-yl methylphosphonate

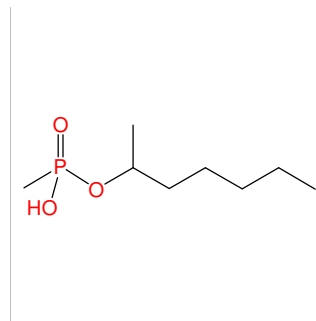

**Chemical name:** Bis(1-methylhexyl) methylphosphonate

Schedule: 2B04

CAS RN: HS code: 2931.39

Key: (543-49-7)-M2B41-(543-49-7)

Molecular formula: C<sub>15</sub>H<sub>33</sub>O<sub>3</sub>P

CAS Index Name: Phosphonic acid, methyl-, bis(1-methylhexyl) ester

**IUPAC name:** Bis(1-methylhexyl) methylphosphonate

Synonyms: Bis(heptan-2-yl) methylphosphonate

Bis(hept-2-yl) methylphosphonate

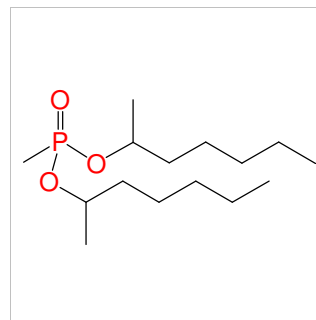

**Chemical name:** 3,5-Dimethylcyclohexyl S-sodium  
isopropylphosphonothiolate

Schedule: 2B04

CAS RN: HS code: 2930.90

Key: (5441-52-1)-I2B42-S(Na)

Molecular formula: C<sub>11</sub>H<sub>22</sub>NaO<sub>2</sub>PS

CAS Index Name: Phosphonothioic acid, 1-methylethyl-, O-(3,5-dimethylcyclohexyl) ester, sodium salt

**IUPAC name:** Sodium O-3,5-Dimethylcyclohexyl  
isopropylphosphonothioate

Synonyms: Phosphonothioic acid, 1-methylethyl-, O-3,5-dimethylcyclohexyl ester, sodium salt

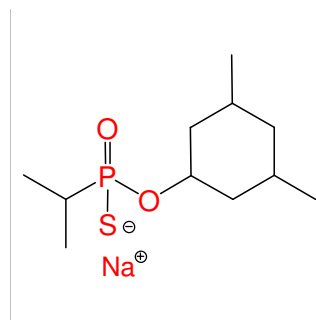

**Chemical name:** 1,2-Dimethylbutyl pinacolyl methylphosphonate

Schedule: 2B04

CAS RN: HS code: 2931.39

Key: (565-60-6)-M2B41-(464-07-3)

Molecular formula: C<sub>13</sub>H<sub>29</sub>O<sub>3</sub>P

CAS Index Name: Phosphonic acid, methyl-, 1,2-dimethylbutyl 1,2,2-trimethylpropyl ester

**IUPAC name:** 1,2-Dimethylbutyl 1,2,2-trimethylpropyl methylphosphonate

Synonyms: O-(1,2-Dimethylbutyl) O-(1,2,2-trimethylpropyl) methylphosphonate

3-Methylpentan-2-yl pinacolyl methylphosphonate

3-Methylpentan-2-yl 3,3-dimethylbutan-2-yl methylphosphonate

3-Methylpentan-2-yl 1,2,2-trimethylpropyl methylphosphonate

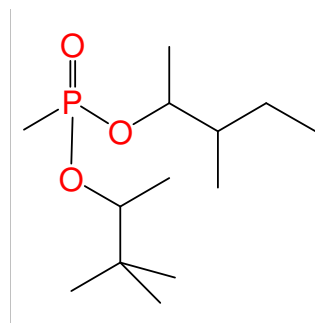

**Chemical name:** Bis(1,2-dimethylbutyl) methylphosphonate

Schedule: 2B04

CAS RN: HS code: 2931.39

Key: (565-60-6)-M2B41-(565-60-6)

Molecular formula: C<sub>13</sub>H<sub>29</sub>O<sub>3</sub>P

CAS Index Name: Phosphonic acid, methyl-, bis(1,2-dimethylbutyl) ester

**IUPAC name:** Bis(1,2-dimethylbutyl) methylphosphonate

Synonyms: O,O-Bis(1,2-dimethylbutyl) methylphosphonate

Bis(3-methylpentan-2-yl) methylphosphonate

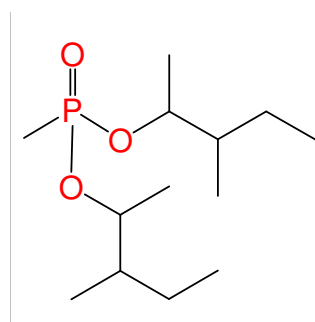

**Chemical name:** 1-Ethyl-2-methylpropyl pinacolyl methylphosphonate

Schedule: 2B04

CAS RN: HS code: 2931.39

Key: (565-67-3)-M2B41-(464-07-3)

Molecular formula: C<sub>13</sub>H<sub>29</sub>O<sub>3</sub>P

CAS Index Name: Phosphonic acid, methyl-, 1-ethyl-2-methylpropyl 1,2,2-trimethylpropyl ester

**IUPAC name:** 1-Ethyl-2-methylpropyl 1,2,2-trimethylpropyl methylphosphonate

Synonyms: O-(1-Isopropylpropyl) O-(1,2,2-trimethylpropyl) methylphosphonate

2-Methylpentan-3-yl pinacolyl methylphosphonate

2-Methylpentan-3-yl 3,3-dimethylbutan-2-yl methylphosphonate

2-Methylpentan-3-yl 1,2,2-trimethylpropyl methylphosphonate

1-Isopropylpropyl pinacolyl methylphosphonate

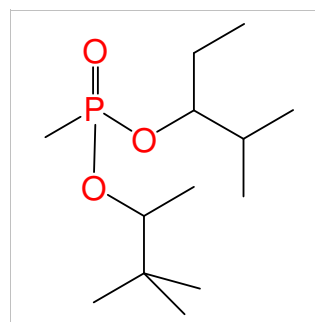

**Chemical name:** Bis(1-ethyl-2-methylpropyl) methylphosphonate

Schedule: 2B04

CAS RN: HS code: 2931.39

Key: (565-67-3)-M2B41-(565-67-3)

Molecular formula: C<sub>13</sub>H<sub>29</sub>O<sub>3</sub>P

CAS Index Name: Phosphonic acid, methyl-, bis(1-ethyl-2-methylpropyl) ester

**IUPAC name:** Bis(1-ethyl-2-methylpropyl) methylphosphonate

Synonyms: O,O-Bis(1-isopropylpropyl) methylphosphonate

Bis(2-methylpentan-3-yl) methylphosphonate

Bis(2-methylpent-3-yl) methylphosphonate

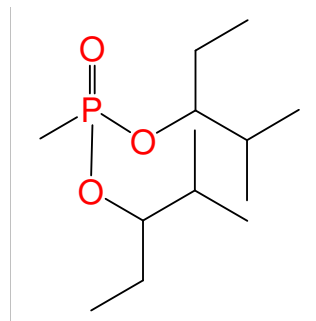

**Chemical name:** 1-Ethylpropyl S-sodium ethylphosphonothiolate

Schedule: 2B04

CAS RN: HS code: 2930.90

Key: (584-02-1)-E2B41-S(Na)

Molecular formula: C<sub>7</sub>H<sub>16</sub>NaO<sub>2</sub>PS

CAS Index Name: Phosphonothioic acid, ethyl-, O-(1-ethylpropyl) ester, sodium salt

**IUPAC name:** Sodium O-(1-ethylpropyl) ethylphosphonothioate

Synonyms: Phosphonothioic acid, ethyl-, O-pent-3-yl ester, sodium salt

Pentan-3-yl S-sodium ethylphosphonothiolate

Pent-3-yl S-sodium ethylphosphonothiolate

O-1-Ethylpropyl S-sodium ethylphosphonothiolate

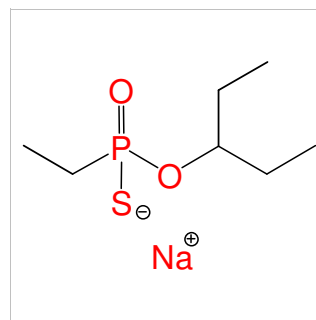

**Chemical name:** O-1-Ethylpropyl O-sodium ethylphosphonothionate

Schedule: 2B04

CAS RN: HS code: 2930.90

Key: (584-02-1)-E2B45-O(Na)

Molecular formula: C<sub>7</sub>H<sub>16</sub>NaO<sub>2</sub>PS

CAS Index Name: Phosphonothioic acid, ethyl-, O-(1-ethylpropyl) ester sodium salt

**IUPAC name:** Sodium O-(1-ethylpropyl) ethylphosphonothionate

Synonyms: Sodium O-pent-3-yl ethylphosphonothionate

Sodium O-(1-ethylpropyl) ethylphosphonothionate

O-Pentan-3-yl-O-sodium ethylphosphonothionate

O-Pent-3-yl-O-sodium ethylphosphonothionate

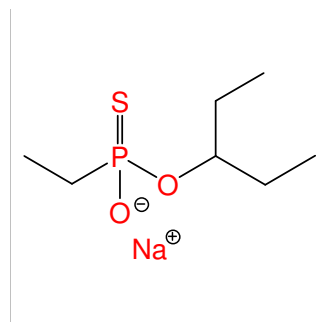

**Chemical name:** 1-Ethylpropyl methylphosphonate

Schedule: 2B04

CAS RN: HS code: 2931.39

Key: (584-02-1)-M2B41

Molecular formula: C<sub>6</sub>H<sub>15</sub>O<sub>3</sub>P

CAS Index Name: Phosphonic acid, methyl-, mono(1-ethylpropyl) ester

**IUPAC name:** 1-Ethylpropyl methylphosphonate

Synonyms: Pentan-3-yl methylphosphonate

Pent-3-yl methylphosphonate

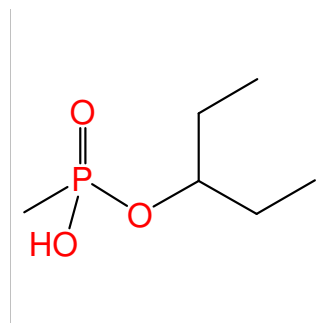

**Chemical name:** O-(1-Ethylpropyl) methylphosphonothionate

Schedule: 2B04

CAS RN: HS code: 2930.90

Key: (584-02-1)-M2B45

Molecular formula: C<sub>6</sub>H<sub>15</sub>O<sub>2</sub>PS

CAS Index Name: Phosphonothioic acid, methyl-, O-(1-ethylpropyl)ester

**IUPAC name:** O-(1-Ethylpropyl) methylphosphonothioate

Synonyms: O-(Pentan-3-yl) methylphosphonothionate

O-(Pent-3-yl) methylphosphonothionate

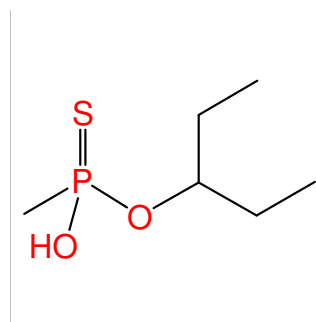

**Chemical name:** O,O-Bis(1-ethylpropyl) methylphosphonothionate

Schedule: 2B04

CAS RN: HS code: 2930.90

Key: (584-02-1)-M2B45-(584-02-1)

Molecular formula: C<sub>11</sub>H<sub>25</sub>O<sub>2</sub>PS

CAS Index Name: Phosphonothioic acid, methyl-, O,O-bis(1-ethylpropyl) ester

**IUPAC name:** O,O-Bis(1-ethylpropyl) methylphosphonothioate

Synonyms: O,O-Bis(pentan-3-yl) methylphosphonothionate

O,O-Bis(pent-3-yl) methylphosphonothionate

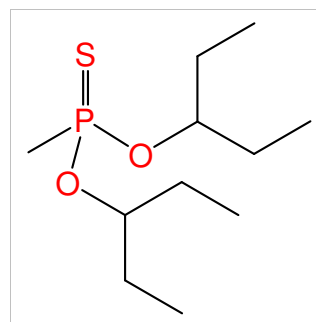

**Chemical name:** 1-Ethylpropyl S-sodium propylphosphonothiolate

Schedule: 2B04

CAS RN: HS code: 2930.90

Key: (584-02-1)-P2B41-S(Na)

Molecular formula: C<sub>8</sub>H<sub>18</sub>NaO<sub>2</sub>PS

CAS Index Name: Phosphonothioic acid, propyl-, O-(1-ethylpropyl) ester, sodium salt

**IUPAC name:** Sodium O-(1-ethylpropyl) propylphosphonothioate

Synonyms: Sodium O-(1-ethylpropyl) propylphosphonothiolate

O-Pentan-3-yl S-sodium propylphosphonothiolate

O-Pent-3-yl S-sodium propylphosphonothiolate

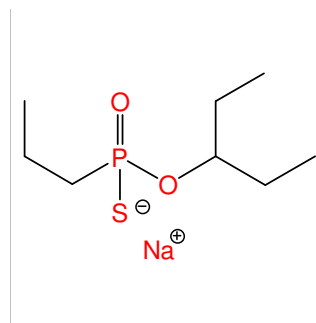

**Chemical name:** 4-Methylpentyl S-sodium propylphosphonothiolate

Schedule: 2B04

CAS RN: HS code: 2930.90

Key: (589-35-5)-P2B41-S(Na)

Molecular formula: C<sub>9</sub>H<sub>20</sub>NaO<sub>2</sub>PS

CAS Index Name: Phosphonothioic acid, propyl-, O-(4-methylpentyl) ester, sodium salt

**IUPAC name:** Sodium O-(4-methylpentyl) propylphosphonothioate

Synonyms:

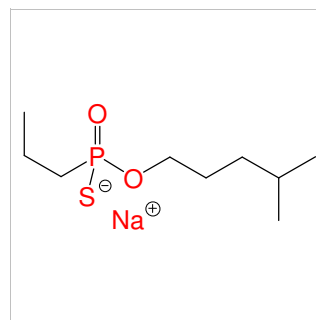

**Chemical name:** 1-Propylbutyl methylphosphonate

Schedule: 2B04

CAS RN: HS code: 2931.39

Key: (589-55-9)-M2B41

Molecular formula: C<sub>8</sub>H<sub>19</sub>O<sub>3</sub>P

CAS Index Name: Phosphonic acid, methyl-, mono(1-propylbutyl) ester

**IUPAC name:** 1-Propylbutyl methylphosphonate

Synonyms: Heptan-4-yl methylphosphonate

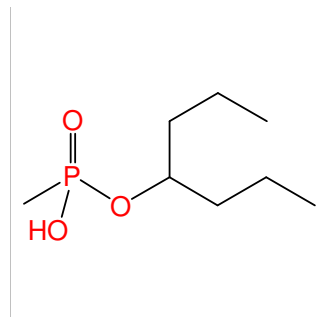

**Chemical name:** Bis(1-propylbutyl) methylphosphonate

Schedule: 2B04

CAS RN: HS code: 2931.39

Key: (589-55-9)-M2B41-(589-55-9)

Molecular formula: C<sub>15</sub>H<sub>33</sub>O<sub>3</sub>P

CAS Index Name: Phosphonic acid, methyl-, bis(1-propylbutyl) ester

**IUPAC name:** Bis(1-propylbutyl) methylphosphonate

Synonyms: Bis(heptan-4-yl) methylphosphonate

Bis(hept-4-yl) methylphosphonate

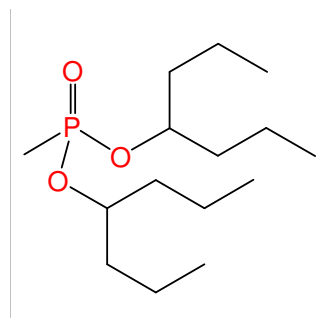

**Chemical name:** O-(1-Propylbutyl) methylphosphonothionate

Schedule: 2B04

CAS RN: HS code: 2930.90

Key: (589-55-9)-M2B45

Molecular formula: C<sub>8</sub>H<sub>19</sub>O<sub>2</sub>PS

CAS Index Name: Phosphonothioic acid, methyl-, O-(1-propylbutyl) ester

**IUPAC name:** O-(1-Propylbutyl) methylphosphonothioate

Synonyms: O-(Heptan-4-yl) methylphosphonothionate

O-(Hept-4-yl) methylphosphonothionate

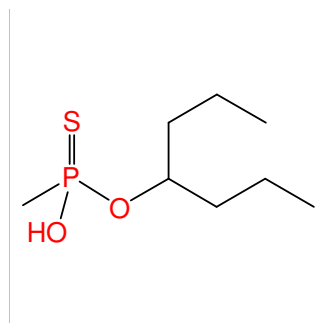

**Chemical name:** O,O-Bis(1-propylbutyl) methylphosphonothionate

Schedule: 2B04

CAS RN: HS code: 2930.90

Key: (589-55-9)-M2B45-(589-55-9)

Molecular formula: C<sub>15</sub>H<sub>33</sub>O<sub>2</sub>PS

CAS Index Name: Phosphonothioic acid, methyl-, O,O-bis(1-propylbutyl) ester

**IUPAC name:** O,O-Bis(1-propylbutyl) methylphosphonothioate

Synonyms: O,O-Bis(heptan-4-yl) methylphosphonothionate

O,O-Bis(hept-4-yl) methylphosphonothionate

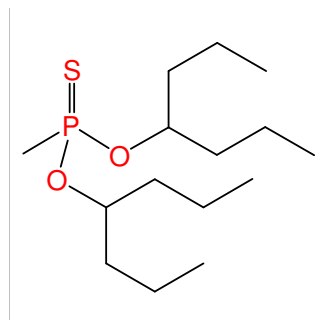

**Chemical name:** O-1,2-Dimethylpropyl O-sodium ethylphosphonothionate

Schedule: 2B04

CAS RN: HS code: 2930.90

Key: (598-75-4)-E2B45-O(Na)

Molecular formula: C<sub>7</sub>H<sub>16</sub>NaO<sub>2</sub>PS

CAS Index Name: Phosphonothioic acid, ethyl-, O-(1,2-dimethylpropyl) ester, sodium salt

**IUPAC name:** Sodium O-(1,2-dimethylpropyl) ethylphosphonothioate

Synonyms: Sodium O-(1,2-dimethylpropyl) ethylphosphonothionate

Phosphonothioic acid, ethyl-, O-3-methylbut-2-yl ester, sodium salt

O-3-Methylbutan-2-yl O-sodium ethylphosphonothionate

O-3-Methylbut-2-yl O-sodium ethylphosphonothionate

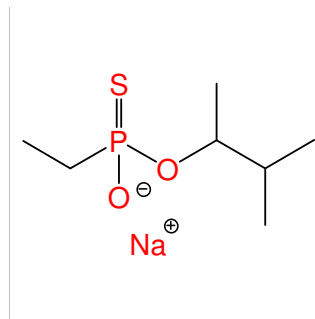



**Chemical name:** 1,2-Dimethylpropyl S-(N-ethylbenzenaminium)  
methylphosphonothiolate (-)

Schedule: 2B04

CAS RN: HS code: 2930.90

Key: (598-75-4)-M2B41-S(103-69-5)-(-)

Molecular formula: C<sub>6</sub>H<sub>14</sub>O<sub>2</sub>PS.C<sub>8</sub>H<sub>12</sub>N

CAS Index Name: Phosphonothioic acid, methyl-, O-(1,2-dimethylpropyl)  
ester N-ethylbenzenaminium salt, (-)

**IUPAC name:** N-ethylanilinium O-(3-methylbutan-2-yl)  
methylphosphonothioate(-)

Synonyms: N-Ethylbenzenaminium O-(3-methylbut-2-yl) methylphosphonothiolate(-)

N-Ethylbenzenaminium O-(1,2-dimethylpropyl) methylphosphonothiolate (-)

N-Ethylbenzenaminium O-(1,2-dimethylpropyl) methylphosphonothioate (-)

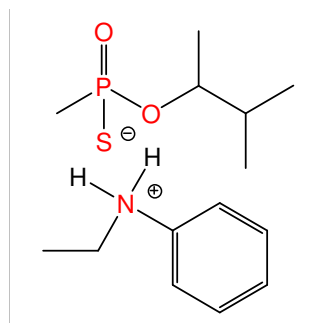

**Chemical name:** 1,2-Dimethylpropyl S-(N-ethylbenzenaminium)  
methylphosphonothiolate (+)

Schedule: 2B04

CAS RN: HS code: 2930.90

Key: (598-75-4)-M2B41-S(103-69-5)-(+)

Molecular formula: C<sub>6</sub>H<sub>14</sub>O<sub>2</sub>PS.C<sub>8</sub>H<sub>12</sub>N

CAS Index Name: Phosphonothioic acid, methyl O-(1,2-dimethylpropyl)  
ester N-ethylbenzenaminium salt

**IUPAC name:** N-ethylanilinium O-(3-methylbutan-2-yl)  
methylphosphonothioate(+)

Synonyms: N-Ethylbenzenaminium O-(3-methylbut-2-yl) methylphosphonothiolate(+)

N-Ethylbenzenaminium O-(1,2-dimethylpropyl) methylphosphonothiolate (+)

N-Ethylbenzenaminium O-(1,2-dimethylpropyl) methylphosphonothioate (+)

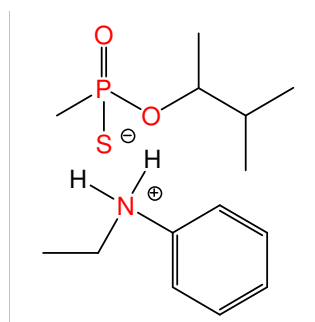

**Chemical name:** 1,2-Dimethylpropyl S-phenylethylamine  
methylphosphonothiolate (-)

Schedule: 2B04

CAS RN: HS code: 2930.90

Key: (598-75-4)-M2B41-S(64-04-0)(-)

Molecular formula: C<sub>14</sub>H<sub>26</sub>NO<sub>2</sub>PS

CAS Index Name:

**IUPAC name:**

Synonyms: 1,2-Dimethylpropyl methylphosphonothiolate S-phenylethylamine salt (-)

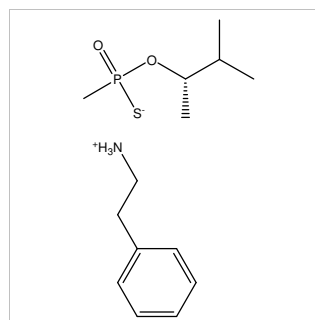

**Chemical name:** 1,2-Dimethylpropyl S-phenylethylamine methylphosphonothiolate (+)

Schedule: 2B04

CAS RN: HS code: 2930.90

Key: (598-75-4)-M2B41-S(64-04-0)(+)

Molecular formula: C<sub>14</sub>H<sub>26</sub>NO<sub>2</sub>PS

CAS Index Name:

**IUPAC name:**

Synonyms: 1,2-Dimethylpropyl methylphosphonothiolate S-phenylethylamine salt (+)

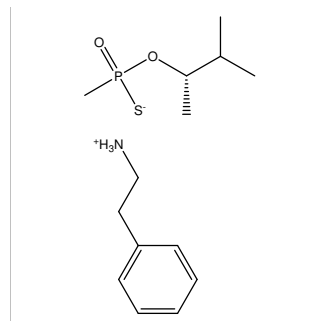

**Chemical name:** 1-Methylbutyl S-sodium methylphosphonothiolate

Schedule: 2B04

CAS RN: HS code: 2930.90

Key: (6032-29-7)-M2B41-S(Na)

Molecular formula: C<sub>6</sub>H<sub>14</sub>NaO<sub>2</sub>PS

CAS Index Name: Phosphonothioic acid, methyl O-(1-methylbutyl) ester, sodium salt

**IUPAC name:** Sodium O-(1-methylbutyl) methylphosphonothioate

Synonyms: Sodium O-(1-methylbutyl) methylphosphonothiolate

Phosphonothioic acid, methyl O-pent-2-yl ester, sodium salt

Pentan-2-yl S-sodium methylphosphonothiolate

Pent-2-yl S-sodium methylphosphonothiolate

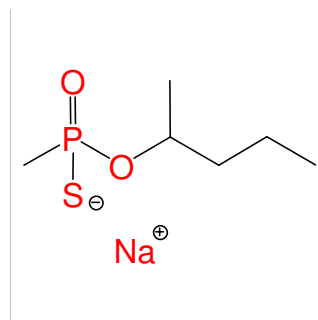

**Chemical name:** O-(1-Methylbutyl) methylphosphonothionate

Schedule: 2B04

CAS RN: HS code: 2930.90

Key: (6032-29-7)-M2B45

Molecular formula: C<sub>6</sub>H<sub>15</sub>O<sub>2</sub>PS

CAS Index Name: Phosphonothioic acid, methyl-, O-(1-methylbutyl) ester

**IUPAC name:** O-(1-Methylbutyl) methylphosphonothioate

Synonyms: O-(Pentan-2-yl) methylphosphonothionate

O-(Pent-2-yl) methylphosphonothionate

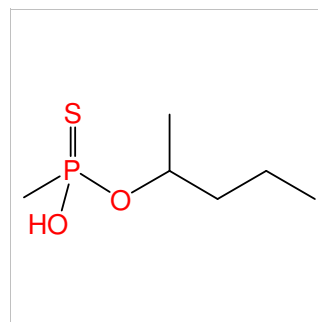

**Chemical name:** O,O-Bis(1-methylbutyl) methylphosphonothionate

Schedule: 2B04

CAS RN: HS code: 2930.90

Key: (6032-29-7)-M2B45-(6032-29-7)

Molecular formula: C<sub>11</sub>H<sub>25</sub>O<sub>2</sub>PS

CAS Index Name: Phosphonothioic acid, methyl-, O,O-bis(1-methylbutyl) ester

**IUPAC name:** O,O-Bis(1-methylbutyl) methylphosphonothioate

Synonyms: O,O-Bis(pentan-2-yl) methylphosphonothionate

O,O-Bis(pent-2-yl) methylphosphonothionate

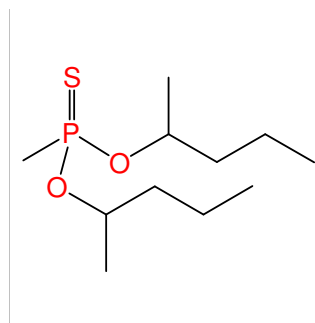

**Chemical name:** 1-Ethylbutyl S-sodium ethylphosphonothiolate

Schedule: 2B04

CAS RN: HS code: 2930.90

Key: (623-37-0)-E2B41-S(Na)

Molecular formula: C<sub>8</sub>H<sub>18</sub>NaO<sub>2</sub>PS

CAS Index Name: Phosphonothioic acid, ethyl-, O-1-ethylbutyl ester, sodium salt

**IUPAC name:** Sodium O-(1-ethylbutyl) ethylphosphonothioate

Synonyms: Phosphonothioic acid, ethyl-, O-hex-3-yl ester, sodium salt

Hexan-3-yl S-sodium ethylphosphonothiolate

Hex-3-yl S-sodium ethylphosphonothiolate

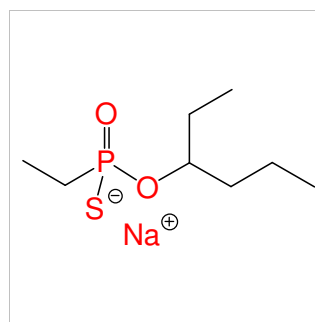

**Chemical name:** 1-Ethylbutyl methylphosphonate

Schedule: 2B04

CAS RN: HS code: 2931.39

Key: (623-37-0)-M2B41

Molecular formula: C<sub>7</sub>H<sub>17</sub>O<sub>3</sub>P

CAS Index Name: Phosphonic acid, methyl-, mono(1-ethylbutyl) ester

**IUPAC name:** 1-Ethylbutyl methylphosphonate

Synonyms: O-(1-Ethylbutyl) methylphosphonate

Hexan-3-yl methylphosphonate

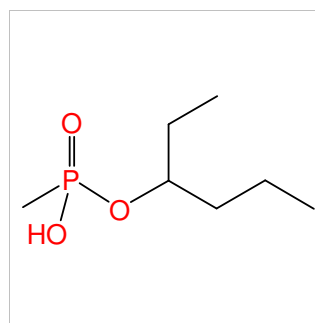

**Chemical name:** 1-Ethylbutyl pinacolyl methylphosphonate

Schedule: 2B04

CAS RN: HS code: 2931.39

Key: (623-37-0)-M2B41-(464-07-3)

Molecular formula: C<sub>13</sub>H<sub>29</sub>O<sub>3</sub>P

CAS Index Name: Phosphonic acid, methyl-, 1-ethylbutyl 1,2,2-trimethylpropyl ester

**IUPAC name:** 1-Ethylbutyl 1,2,2-trimethylpropyl methylphosphonate

Synonyms: O-(1-Ethylbutyl) O-(1,2,2-trimethylpropyl) methylphosphonate

Hexan-3-yl pinacolyl methylphosphonate

Hexan-3-yl 3,3-dimethylbutan-2-yl methylphosphonate

Hexan-3-yl 1,2,2-trimethylpropyl methylphosphonate

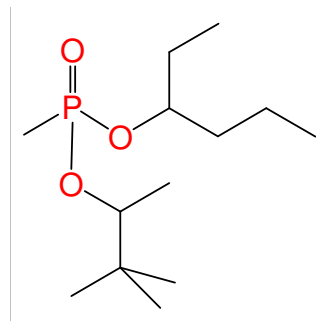

**Chemical name:** 1-Butylpentyl methylphosphonate

Schedule: 2B04

CAS RN: HS code: 2931.39

Key: (623-93-8)-M2B41

Molecular formula: C<sub>10</sub>H<sub>23</sub>O<sub>3</sub>P

CAS Index Name: Phosphonic acid, methyl-, mono(1-butylpentyl) ester

**IUPAC name:** 1-Butylpentyl methylphosphonate

Synonyms: Nonan-5-yl methylphosphonate

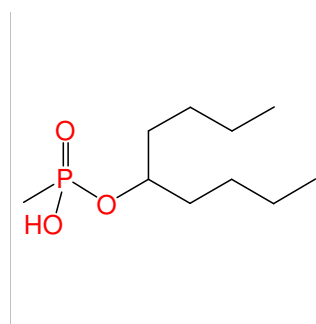

**Chemical name:** Bis(1-butylpentyl) methylphosphonate

Schedule: 2B04

CAS RN: HS code: 2931.39

Key: (623-93-8)-M2B41-(623-93-8)

Molecular formula: C<sub>19</sub>H<sub>41</sub>O<sub>3</sub>P

CAS Index Name: Phosphonic acid, methyl-, bis(1-butylpentyl) ester

**IUPAC name:** Bis(1-butylpentyl) methylphosphonate

Synonyms: O,O-Bis(1-butylpentyl) methylphosphonate

Bis(nonan-5-yl) methylphosphonate

Bis(non-5-yl) methylphosphonate

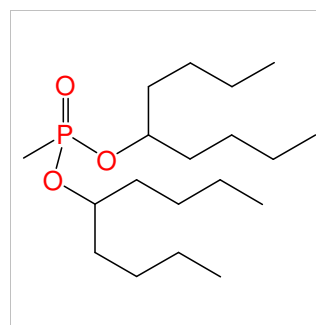

**Chemical name:** O-(1-Butylpentyl) methylphosphonothionate

Schedule: 2B04

CAS RN: HS code: 2930.90

Key: (623-93-8)-M2B45

Molecular formula: C<sub>10</sub>H<sub>23</sub>O<sub>2</sub>PS

CAS Index Name: Phosphonothioic acid, methyl-, O-(1-butylpentyl)ester

**IUPAC name:** O-(1-Butylpentyl) methylphosphonothioate

Synonyms: O-(Nonan-5-yl) methylphosphonothionate

O-(Non-5-yl) methylphosphonothionate

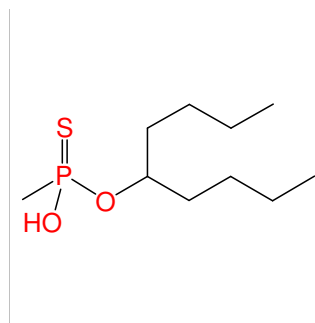

**Chemical name:** O-3,3-Dimethylbutyl-O-sodium ethylphosphonothionate

Schedule: 2B04

CAS RN: HS code: 2930.90

Key: (624-95-3)-E2B45-O(Na)

Molecular formula: C<sub>8</sub>H<sub>18</sub>NaO<sub>2</sub>PS

CAS Index Name: Phosphonothioic acid, ethyl-, O-(3,3-dimethylbutyl) ester sodium salt

**IUPAC name:** Sodium O-(3,3-dimethylbutyl) ethylphosphonothiolate

Synonyms: Sodium O-(3,3-dimethylbutyl) ethylphosphonothionate

O-3,3-Dimethylbutyl-O-sodium ethylphosphonothionate

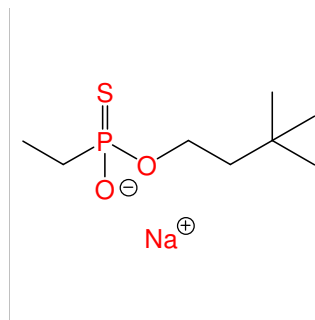

**Chemical name:** 3,3-Dimethylbutyl S-sodium methylphosphonothiolate

Schedule: 2B04

CAS RN: HS code: 2930.90

Key: (624-95-3)-M2B41-S(Na)

Molecular formula: C<sub>7</sub>H<sub>16</sub>NaO<sub>2</sub>PS

CAS Index Name: Phosphonothioic acid, methyl-, O-(3,3-dimethylbutyl) ester, sodium salt

**IUPAC name:** Sodium O-(3,3-dimethylbutyl) methylphosphonothioate

Synonyms:

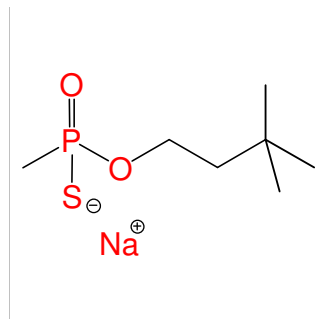

**Chemical name:** 1-Methylpentyl S-sodium ethylphosphonothiolate

Schedule: 2B04

CAS RN: HS code: 2930.90

Key: (626-93-7)-E2B41-S(Na)

Molecular formula: C<sub>8</sub>H<sub>18</sub>NaO<sub>2</sub>PS

CAS Index Name: Phosphonothioic acid, ethyl-, O-(1-methylpentyl) ester, sodium salt

**IUPAC name:** Sodium O-(1-methylpentyl) ethylphosphonothioate

Synonyms: Phosphonothioic acid, ethyl-, O-hex-2-yl ester, sodium salt

Hexan-2-yl S-sodium ethylphosphonothiolate

Hex-2-yl S-sodium ethylphosphonothiolate

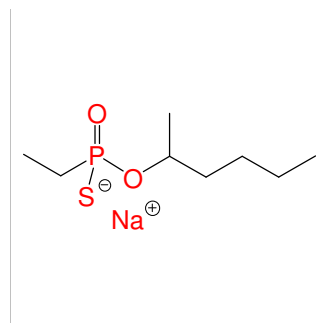

**Chemical name:** O-1-Methylpentyl O-sodium ethylphosphonothionate

Schedule: 2B04

CAS RN: HS code: 2930.90

Key: (626-93-7)-E2B45-O(Na)

Molecular formula: C<sub>8</sub>H<sub>18</sub>NaO<sub>2</sub>PS

CAS Index Name: Phosphonothioic acid, ethyl-, O-(1-methylpentyl) ester sodium salt

**IUPAC name:** Sodium O-(1-methylpentyl) ethylphosphonothionate

Synonyms: Sodium O-(1-methylpentyl) ethylphosphonothionate

O-Hexan-2-yl O-sodium ethylphosphonothionate

O-Hex-2-yl O-sodium ethylphosphonothionate

O-1-Methylpentyl O-sodium ethylphosphonothionate

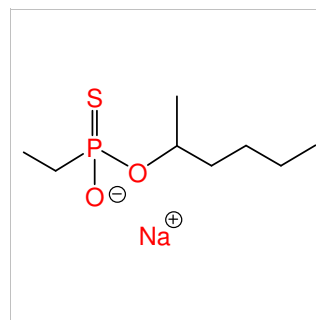

**Chemical name:** O-(1-Methylpentyl) methylphosphonothionate

Schedule: 2B04

CAS RN: HS code: 2930.90

Key: (626-93-7)-M2B45

Molecular formula: C<sub>7</sub>H<sub>17</sub>O<sub>2</sub>PS

CAS Index Name: Phosphonothioic acid, methyl-, O-(1-methylpentyl) ester

**IUPAC name:** O-(1-Methylpentyl) methylphosphonothioate

Synonyms: O-(Hexan-2-yl) methylphosphonothionate

O-(Hex-2-yl) methylphosphonothionate

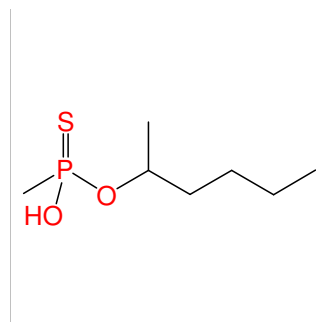

**Chemical name:** O,O-Bis(1-methylpentyl) methylphosphonothionate

Schedule: 2B04

CAS RN: HS code: 2930.90

Key: (626-93-7)-M2B45-(626-93-7)

Molecular formula: C<sub>13</sub>H<sub>29</sub>O<sub>2</sub>PS

CAS Index Name: Phosphonothioic acid, methyl-, O,O-bis(1-methylpentyl) ester

**IUPAC name:** O,O-Bis(1-methylpentyl) methylphosphonothioate

Synonyms: O,O-Bis(hexan-2-yl) methylphosphonothionate

O,O-Bis(hex-2-yl) methylphosphonothionate

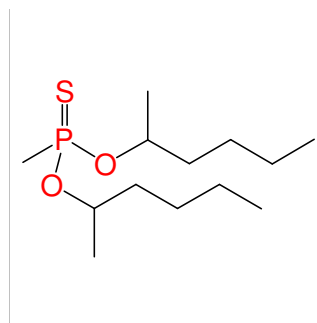

**Chemical name:** 1-Methyloctyl methylphosphonate

Schedule: 2B04

CAS RN: HS code: 2931.39

Key: (628-99-9)-M2B41

Molecular formula: C<sub>10</sub>H<sub>23</sub>O<sub>3</sub>P

CAS Index Name: Phosphonic acid, methyl-, mono(1-methyloctyl) ester

**IUPAC name:** 1-Methyloctyl methylphosphonate

Synonyms: Nonan-2-yl methylphosphonate

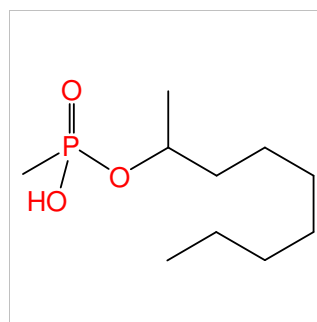

**Chemical name:** Bis(1-methyloctyl) methylphosphonate

Schedule: 2B04

CAS RN: HS code: 2931.39

Key: (628-99-9)-M2B41-(628-99-9)

Molecular formula: C<sub>19</sub>H<sub>41</sub>O<sub>3</sub>P

CAS Index Name: Phosphonic acid, methyl-, bis(1-methyloctyl) ester

**IUPAC name:** Bis(1-methyloctyl) methylphosphonate

Synonyms: Bis(nonan-2-yl) methylphosphonate

Bis(non-2-yl) methylphosphonate

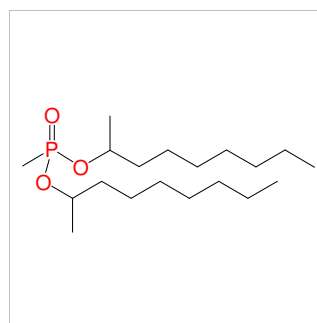

**Chemical name:** O-Ethyl ethylphosphonothiolate

Schedule: 2B04

CAS RN: HS code: 2930.90

Key: (64-17-5)-E2B41-SH

Molecular formula: C<sub>4</sub>H<sub>11</sub>O<sub>2</sub>PS

CAS Index Name: Phosphonothioic acid, ethyl-, O-ethyl ester

**IUPAC name:** O-Ethyl hydrogen ethylphosphonothioate

Synonyms:

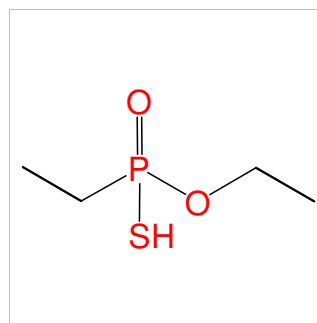

**Chemical name:** O-Ethyl O-methyl isopropylphosphonate

Schedule: 2B04

CAS RN: HS code: 2931.39

Key: (64-17-5)-I2B41-(67-56-1)

Molecular formula: C<sub>6</sub>H<sub>15</sub>O<sub>3</sub>P

CAS Index Name:

**IUPAC name:**

Synonyms: Ethyl methyl isopropylphosphonate

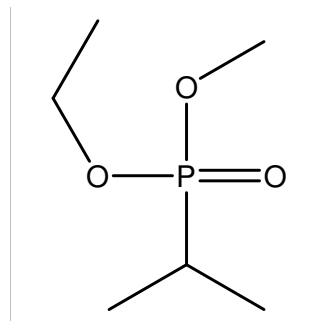

**Chemical name:** Ethyl S-sodium isopropylphosphonothiolate

Schedule: 2B04

CAS RN: HS code: 2930.90

Key: (64-17-5)-I2B41-S(Na)

Molecular formula: C<sub>5</sub>H<sub>12</sub>NaO<sub>2</sub>PS

CAS Index Name: Phosphonothioic acid, 1-methylethyl-, O-ethyl ester, sodium salt

**IUPAC name:** Sodium O-ethyl isopropylphosphonothioate

Synonyms: Sodium O-ethyl isopropylphosphonothiolate

O-Ethyl S-sodium isopropylphosphonothiolate

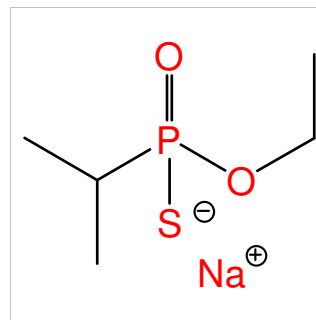

**Chemical name:** Diethyl methyl-[14C]-phosphonate

Schedule: 2B04

CAS RN: HS code: 2845.90

Key: (64-17-5)-M(14C)2B41-(64-17-5)

Molecular formula: C(14C)C<sub>4</sub>H<sub>13</sub>O<sub>3</sub>P

CAS Index Name:

**IUPAC name:**

Synonyms:

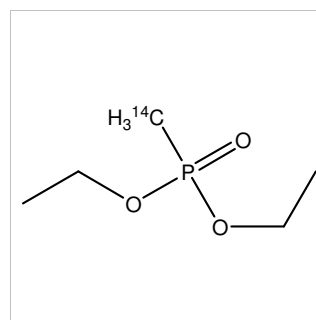

**Chemical name:** O-(N,N-dipropylamino)ethyl methylphosphonofluoridate

Schedule: 2B04

CAS RN: HS code: 2931.39

Key: (64-17-5)-M1A1-PP

Molecular formula: C<sub>9</sub>H<sub>21</sub>FNO<sub>2</sub>P

CAS Index Name: Phosphonofluoric acid, methyl-, N,N-dipropylaminoethyl ester

**IUPAC name:** 2-(Dipropylamino)ethyl methylphosphonofluoridate

Synonyms: N,N-dipropylaminoethyl methylphosphonofluoridate

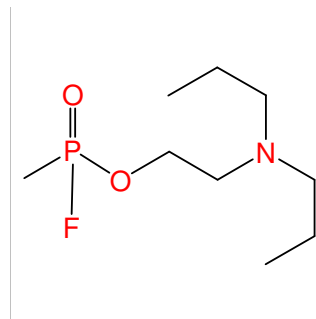



**Chemical name:** Ethyl N-methyl-N-(2-hydroxyethyl)  
methylphosphonamidate

Schedule: 2B04

CAS RN: HS code: 2931.39

Key: (64-17-5)-M2B41-N(65-56-1)(107-21-1)

Molecular formula: C<sub>6</sub>H<sub>16</sub>NO<sub>3</sub>P

CAS Index Name:

**IUPAC name:** Ethyl N-(2-hydroxyethyl)-N,P-dimethylphosphonamidoate

Synonyms:

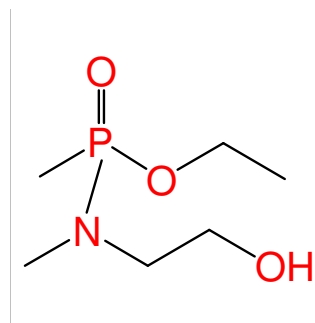

**Chemical name:** Ethyl S-ammonium methylphosphonothiolate

Schedule: 2B04

CAS RN: HS code: 2930.90

Key: (64-17-5)-M2B41-S(NH<sub>4</sub>)

Molecular formula: C<sub>3</sub>H<sub>12</sub>NO<sub>2</sub>PS

CAS Index Name: Phosphonothioic acid, methyl-, O-ethyl ester, ammonium salt

**IUPAC name:** Ammonium O-ethyl methylphosphonothioate

Synonyms:

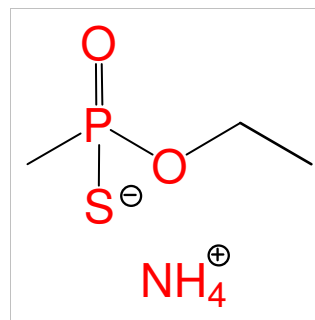

**Chemical name:** O-2-Diisopropylaminoethyl O-ethyl  
methylphosphonothionate

Schedule: 2B04

CAS RN: HS code: 2930.90

Key: (64-17-5)-M2B45-(96-80-0)

Molecular formula: C<sub>11</sub>H<sub>26</sub>NO<sub>2</sub>PS

CAS Index Name: Phosphonothioic acid, methyl-, O-{2-[bis(1-methylethyl)amino]ethyl} O-ethyl ester

**IUPAC name:** O-2-Diisopropylaminoethyl O-ethyl  
methylphosphonothioate

Synonyms: O-ethyl O-[2-(diisopropylamino)ethyl] methylphosphonothioate

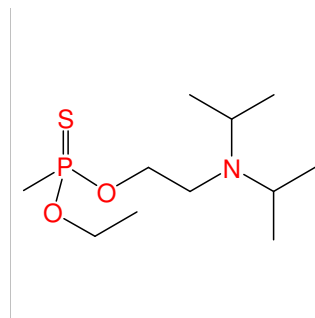

**Chemical name:** O-2-Diisopropylammoniummethyl O-ethyl methylphosphonothionate chloride

Schedule: 2B04

CAS RN: HS code: 2930.90

Key: (64-17-5)-M2B45-(96-80-0)-(HCl)

Molecular formula: C<sub>11</sub>H<sub>27</sub>ClNO<sub>2</sub>PS

CAS Index Name: 2-Propanaminium, N-{2-[ethoxy(methyl)phosphorothioxyloxy]ethyl}-N-(1-methylethyl)-, chloride

**IUPAC name:** N-{2-[ethoxy(methyl)phosphorothioxyloxy]ethyl}-N-isopropylpropan-2-aminium chloride

Synonyms: O-Ethyl O-[2-(diisopropylamino)ethyl] methylphosphonothioate hydrochloride

N-(2-{[ethoxy(methyl)phosphorothioyl]oxy}ethyl)-N-(propan-2-yl)propan-2-aminium

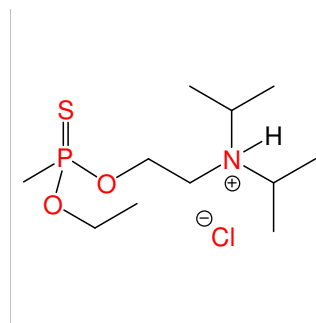

**Chemical name:** O-Ethyl O-sodium propylphosphonothionate

Schedule: 2B04

CAS RN: HS code: 2930.90

Key: (64-17-5)-P2B45-O(Na)

Molecular formula: C<sub>5</sub>H<sub>12</sub>NaO<sub>2</sub>PS

CAS Index Name: Phosphonothioic acid, propyl-, O-ethyl ester sodium salt

**IUPAC name:** Sodium O-ethyl propylphosphonothioate

Synonyms: Sodium O-ethyl propylphosphonothionate

O-Ethyl O-sodium propylphosphonothionate

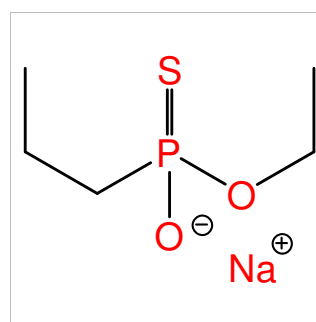

**Chemical name:** Methyl S-sodium ethylphosphonothiolate

Schedule: 2B04

CAS RN: HS code: 2930.90

Key: (67-56-1)-E2B41-S(Na)

Molecular formula: C<sub>3</sub>H<sub>8</sub>NaO<sub>2</sub>PS

CAS Index Name: Phosphonothioic acid, ethyl-, O-methyl ester, sodium salt

**IUPAC name:** Sodium O-methyl ethylphosphonothioate

Synonyms:

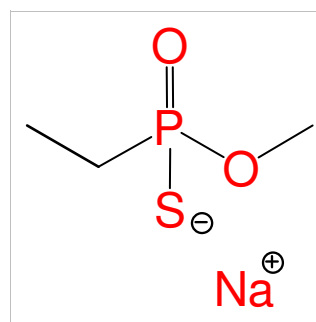

**Chemical name:** O-Methyl ethylphosphonothiolate

Schedule: 2B04

CAS RN: HS code: 2930.90

Key: (67-56-1)-E2B41-SH

Molecular formula: C<sub>3</sub>H<sub>9</sub>O<sub>2</sub>PS

CAS Index Name: Phosphonothioic acid, ethyl-, O-methyl ester

**IUPAC name:** O-Methyl hydrogen ethylphosphonothioate

Synonyms: O-Methyl ethylphosphonothiolate

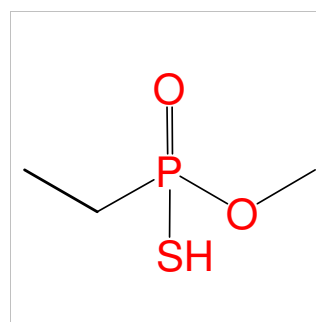

**Chemical name:** Methyl S-sodium isopropylphosphonothiolate

Schedule: 2B04

CAS RN: HS code: 2930.90

Key: (67-56-1)-I2B41-S(Na)

Molecular formula: C<sub>4</sub>H<sub>10</sub>NaO<sub>2</sub>PS

CAS Index Name: Phosphonothioic acid, 1-methylethyl-, O-methyl ester, sodium salt

**IUPAC name:** Sodium O-methyl isopropylphosphonothioate

Synonyms:

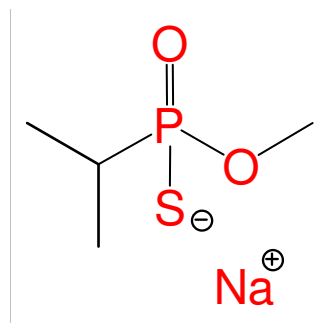

**Chemical name:** O-Methyl isopropylphosphonothiolate

Schedule: 2B04

CAS RN: HS code: 2930.90

Key: (67-56-1)-I2B41-SH

Molecular formula: C<sub>4</sub>H<sub>11</sub>O<sub>2</sub>PS

CAS Index Name: Phosphonic acid, (1-methylethyl)-, O-methyl ester

**IUPAC name:** O-Methyl hydrogen isopropylphosphonothioate

Synonyms: O-Methyl S-hydrogen isopropylphosphonothiolate  
O-Methyl hydrogen isopropylphosphonothiolate

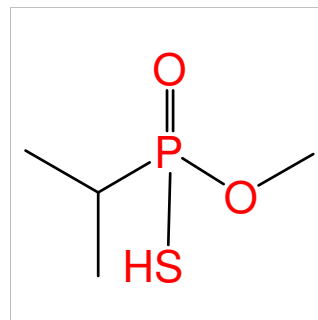

**Chemical name:** Methyl 4-methylcyclohexyl methylphosphonate

Schedule: 2B04

CAS RN: HS code: 2931.39

Key: (67-56-1)-M2B41-(589-91-3)

Molecular formula: C<sub>9</sub>H<sub>19</sub>O<sub>3</sub>P

CAS Index Name:

**IUPAC name:**

Synonyms: O-Methyl O-4-methylcyclohexyl methylphosphonate

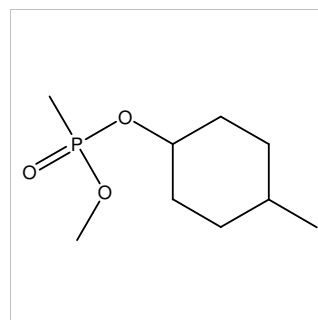

**Chemical name:** O,O-dimethyl methylphosphonate-d<sub>6</sub>

Schedule: 2B04

CAS RN: HS code: 2845.90

Key: (67-56-1)-M2B41-(67-56-1)-D6

Molecular formula: C<sub>3</sub>H<sub>3</sub>D<sub>6</sub>O<sub>3</sub>P

CAS Index Name:

**IUPAC name:**

Synonyms:

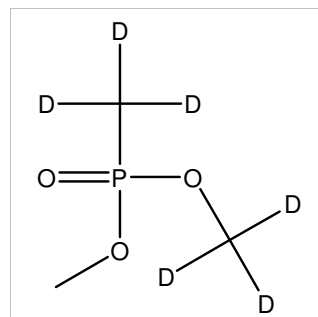

**Chemical name:** Methyl S-pentyl methylphosphonothiolate

Schedule: 2B04

CAS RN: HS code: 2930.90

Key: (67-56-1)-M2B41-S(71-41-0)

Molecular formula: C<sub>7</sub>H<sub>17</sub>O<sub>2</sub>PS

CAS Index Name: Phosphonothioic acid, methyl-, O-methyl S-pentyl ester

**IUPAC name:** Methyl S-pentyl methylphosphonothioate

Synonyms: O-Methyl S-pentyl methylphosphonothiolate

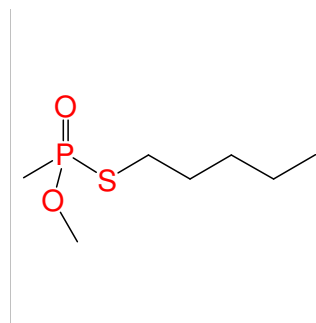

**Chemical name:** O-Methyl methylphosphonothiolate

Schedule: 2B04

CAS RN: HS code: 2930.90

Key: (67-56-1)-M2B41-SH

Molecular formula: C<sub>2</sub>H<sub>7</sub>O<sub>2</sub>PS

CAS Index Name: Phosphonothioic acid, methyl-, O-methyl ester

**IUPAC name:** O-Methyl hydrogen methylphosphonothioate

Synonyms: O-Methyl methylphosphonothiolate

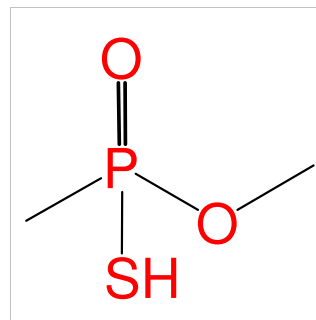

**Chemical name:** Methyl S-sodium propylphosphonothiolate

Schedule: 2B04

CAS RN: HS code: 2930.90

Key: (67-56-1)-P2B41-S(Na)

Molecular formula: C<sub>4</sub>H<sub>10</sub>NaO<sub>2</sub>PS

CAS Index Name: Phosphonothioic acid, propyl-, O-methyl ester, sodium salt

**IUPAC name:** Sodium O-methyl propylphosphonothioate

Synonyms:

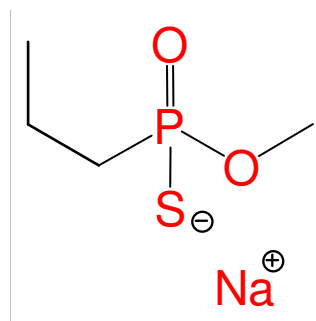

**Chemical name:** Isopropyl propyl ethylphosphonate

Schedule: 2B04

CAS RN: HS code: 2931.39

Key: (67-63-0)-E2B41-(71-23-8)

Molecular formula: C<sub>8</sub>H<sub>19</sub>O<sub>3</sub>P

CAS Index Name: Phosphonic acid, ethyl-, 1-methylethyl propyl ester

**IUPAC name:** Isopropyl propyl ethylphosphonate

Synonyms: O-Isopropyl O-propyl ethylphosphonate

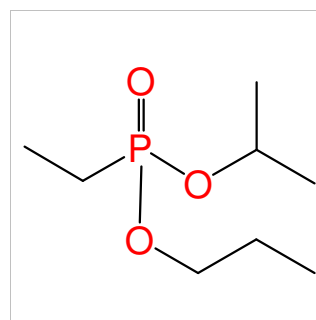

**Chemical name:** Isopropyl S-sodium isopropylphosphonothiolate

Schedule: 2B04

CAS RN: HS code: 2930.90

Key: (67-63-0)-I2B41-S(Na)

Molecular formula: C<sub>6</sub>H<sub>14</sub>NaO<sub>2</sub>PS

CAS Index Name: Phosphonothioic acid, 1-methylethyl-, O-1-methylethyl ester, sodium salt

**IUPAC name:** Sodium O-isopropyl isopropylphosphonothioate

Synonyms: Sodium O-isopropyl isopropylphosphonothiolate

O-Isopropyl S-sodium isopropylphosphonothiolate

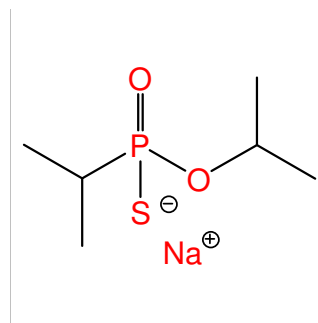

**Chemical name:** Isopropyl isopropylphosphinate

Schedule: 2B04

CAS RN: HS code: 2931.39

Key: (67-63-0)-I2B42

Molecular formula: C<sub>6</sub>H<sub>15</sub>O<sub>2</sub>P

CAS Index Name: Phosphinic acid, 1-methylethyl-, 1-methylethyl ester

**IUPAC name:**

Synonyms:

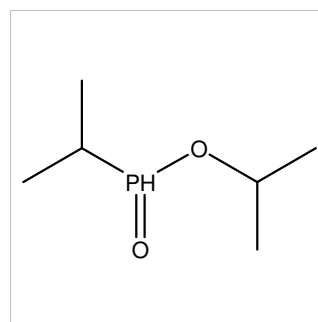

**Chemical name:** Isopropyl isopropylphosphinothionate

Schedule: 2B04

CAS RN: HS code: 2930.90

Key: (67-63-0)-I2B42(S)

Molecular formula: C<sub>16</sub>H<sub>15</sub>O<sub>2</sub>PS

CAS Index Name:

**IUPAC name:**

Synonyms: Phosphinothioic acid, 1-methylethyl-, 1-methylethyl ester

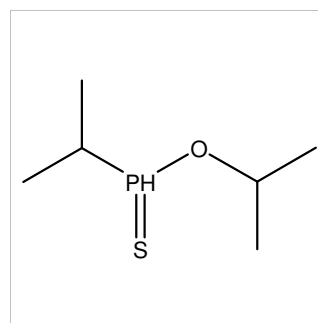

**Chemical name:** Isopropyl N-methyl-N-(2-hydroxyethyl) methylphosphonoamidate

Schedule: 2B04

CAS RN: HS code: 2931.39

Key: (67-63-0)-M2B41-N(65-56-1)(107-21-1)

Molecular formula: C<sub>7</sub>H<sub>18</sub>NO<sub>3</sub>P

CAS Index Name:

**IUPAC name:** Propan-2-yl N-(2-hydroxyethyl)-N,P-dimethylphosphonamidoate

Synonyms:

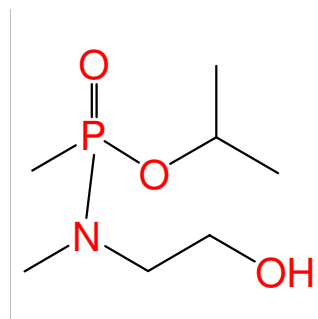

**Chemical name:** Isopropyl S-sodium propylphosphonothiolate

Schedule: 2B04

CAS RN: HS code: 2930.90

Key: (67-63-0)-P2B41-S(Na)

Molecular formula: C<sub>6</sub>H<sub>14</sub>NaO<sub>2</sub>PS

CAS Index Name: Phosphonothioic acid, propyl-, O-(1-methylethyl) ester, sodium salt

**IUPAC name:** Sodium O-isopropyl propylphosphonothioate

Synonyms:

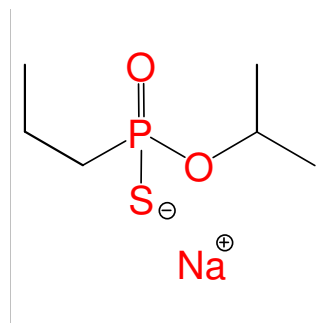

**Chemical name:** Cyclooctyl S-sodium propylphosphonothiolate

Schedule: 2B04

CAS RN: HS code: 2930.90

Key: (696-71-6)-P2B41-S(Na)

Molecular formula: C<sub>11</sub>H<sub>22</sub>NaO<sub>2</sub>PS

CAS Index Name: Phosphonothioic acid, propyl-, O-cyclooctyl ester, sodium salt

**IUPAC name:** Sodium O-cyclooctyl propylphosphonothioate

Synonyms:

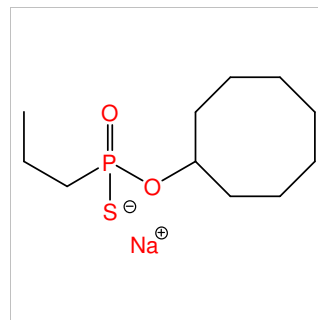

**Chemical name:** Cyclooctyl S-sodium isopropylphosphonothiolate

Schedule: 2B04

CAS RN: HS code: 2930.90

Key: (696-71-9)-I2B41-S(Na)

Molecular formula: C<sub>11</sub>H<sub>22</sub>NaO<sub>2</sub>PS

CAS Index Name:

**IUPAC name:**

Synonyms:

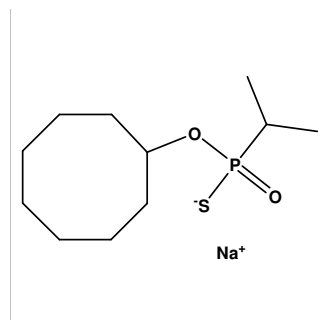

**Chemical name:** Propyl S-sodium ethylphosphonothiolate

Schedule: 2B04

CAS RN: HS code: 2930.90

Key: (71-23-8)-E2B41-S(Na)

Molecular formula: C<sub>5</sub>H<sub>12</sub>NaO<sub>2</sub>PS

CAS Index Name: Phosphonothioic acid, ethyl-, O-propyl ester, sodium salt

**IUPAC name:** Sodium O-propyl ethylphosphonothioate

Synonyms:

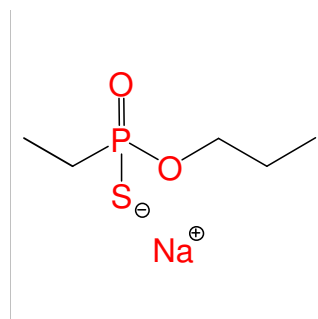

**Chemical name:** Propyl S-sodium isopropylphosphonothiolate

Schedule: 2B04

CAS RN: HS code: 2930.90

Key: (71-23-8)-I2B41-S(Na)

Molecular formula: C<sub>6</sub>H<sub>14</sub>NaO<sub>2</sub>PS

CAS Index Name: Phosphonothioic acid, 1-methylethyl-, O-propyl ester, sodium salt

**IUPAC name:** Sodium O-propyl isopropylphosphonothioate

Synonyms: Sodium O-propyl isopropylphosphonothiolate

O-Propyl S-sodium isopropylphosphonothiolate

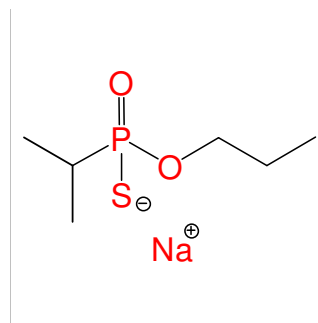

**Chemical name:** Propyl S-dicyclohexylammonium methylphosphonothiolate

Schedule: 2B04

CAS RN: HS code: 2930.90

Key: (71-23-8)-M2B41-S(101-83-7)

Molecular formula: C<sub>16</sub>H<sub>34</sub>NO<sub>2</sub>PS

CAS Index Name: Phosphonothioic acid, methyl-, O-propyl ester, compd. with dicyclohexylamine

**IUPAC name:** N,N-Dicyclohexyl-S-[methyl(propoxy)phosphoryl]thiohydroxylammonium

Synonyms: O-Propyl methylphosphonothioic acid, dicyclohexylammonium salt

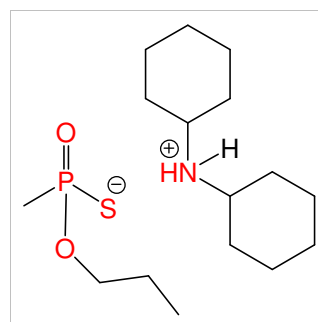

**Chemical name:** O-Propyl methylphosphonothiolate

Schedule: 2B04

CAS RN: HS code: 2930.90

Key: (71-23-8)-M2B41-SH

Molecular formula: C<sub>4</sub>H<sub>11</sub>O<sub>2</sub>PS

CAS Index Name: Phosphonothioic acid, methyl-, O-propyl ester

**IUPAC name:** O-Propyl hydrogen methylphosphonothioate

Synonyms:

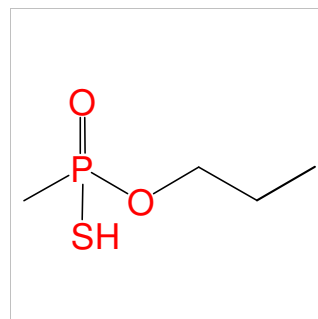

**Chemical name:** Propyl S-sodium propylphosphonothiolate

Schedule: 2B04

CAS RN: HS code: 2930.90

Key: (71-23-8)-P2B41-S(Na)

Molecular formula: C<sub>6</sub>H<sub>14</sub>NaO<sub>2</sub>PS

CAS Index Name: Phosphonothioic acid, propyl-, O-propyl ester sodium salt

**IUPAC name:** Sodium O-propyl propylphosphonothioate

Synonyms: Sodium O-propyl propylphosphonothiolate

O-Propyl S-sodium propylphosphonothiolate

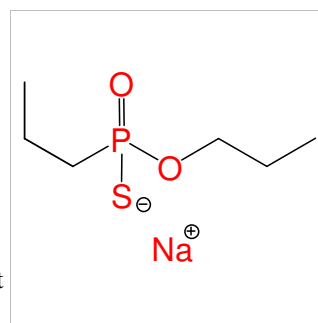

**Chemical name:** O-Butyl O-methyl isopropylphosphonate

Schedule: 2B04

CAS RN: HS code: 2931.39

Key: (71-36-3)-I2B41-(67-56-1)

Molecular formula: C<sub>8</sub>H<sub>19</sub>O<sub>3</sub>P

CAS Index Name:

**IUPAC name:**

Synonyms: n-Butyl methyl isopropylphosphonate

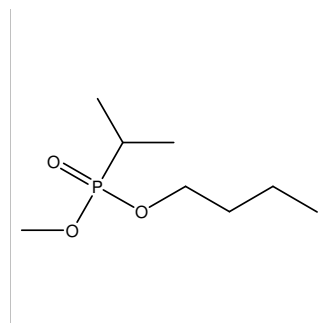

**Chemical name:** Butyl S-sodium isopropylphosphonothiolate

Schedule: 2B04

CAS RN: HS code: 2930.90

Key: (71-36-3)-I2B41-S(Na)

Molecular formula: C<sub>7</sub>H<sub>16</sub>NaO<sub>2</sub>PS

CAS Index Name: Phosphonothioic acid, 1-methylethyl-, O-butyl ester, sodium salt

**IUPAC name:** Sodium O-butyl isopropylphosphonothioate

Synonyms: O-Butyl S-sodium isopropylphosphonothiolate

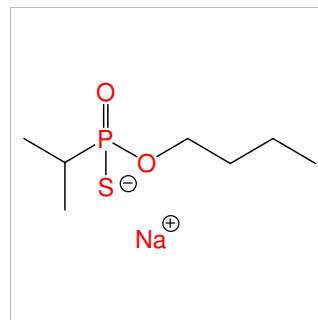

**Chemical name:** Butyl S-ammonium methylphosphonothiolate

Schedule: 2B04

CAS RN: HS code: 2930.90

Key: (71-36-3)-M2B41-S(NH<sub>4</sub>)

Molecular formula: C<sub>5</sub>H<sub>16</sub>NO<sub>2</sub>PS

CAS Index Name: Phosphonothioic acid, methyl-, O-butyl ester, ammonium salt

**IUPAC name:** Ammonium O-butyl methylphosphonothioate

Synonyms:

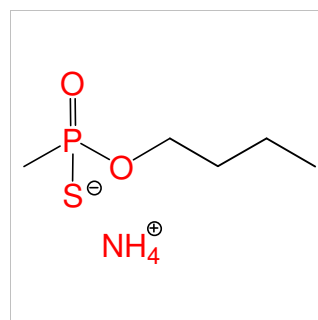

**Chemical name:** O-Butyl methylphosphonothionate

Schedule: 2B04

CAS RN: HS code: 2930.90

Key: (71-36-3)-M2B45

Molecular formula: C<sub>5</sub>H<sub>13</sub>O<sub>2</sub>PS

CAS Index Name: Phosphonothioic acid, methyl-, O-butyl ester

**IUPAC name:** O-Butyl methylphosphonothioate

Synonyms:

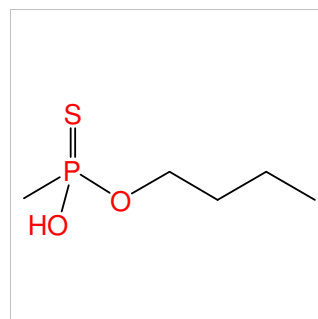



**Chemical name:** Butyl S-sodium propylphosphonothiolate

Schedule: 2B04

CAS RN: HS code: 2930.90

Key: (71-36-3)-P2B41-S(Na)

Molecular formula: C<sub>7</sub>H<sub>16</sub>NaO<sub>2</sub>PS

CAS Index Name: Phosphonothioic acid, propyl-, O-butyl ester, sodium salt

**IUPAC name:** Sodium O-butyl propylphosphonothioate

Synonyms: Sodium O-butyl propylphosphonothiolate

O-Butyl S-sodium propylphosphonothiolate

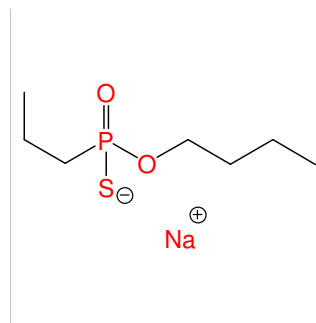

**Chemical name:** O-Pentyl methylphosphonothionate

Schedule: 2B04

CAS RN: HS code: 2930.90

Key: (71-41-0)-M2B45

Molecular formula: C<sub>6</sub>H<sub>15</sub>O<sub>2</sub>PS

CAS Index Name: Phosphonothioic acid, methyl-, O-pentyl ester

**IUPAC name:** O-Pentyl methylphosphonothioate

Synonyms:

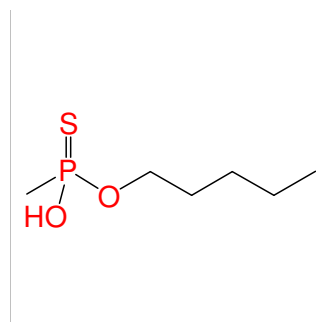

**Chemical name:** Dimethyl-d6 methylphosphonate

Schedule: 2B04

CAS RN: HS code: 2845.90

Key: (756-79-6)-D6

Molecular formula: C<sub>3</sub>H<sub>3</sub>D<sub>6</sub>O<sub>3</sub>P

CAS Index Name: Phosphonic acid, methyl-, di(methyl-d3) ester

**IUPAC name:**

Synonyms: Bis[(2H<sub>3</sub>)methyl] methylphosphonate

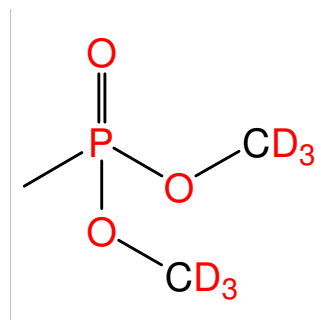

**Chemical name:** 2,2-Dimethylpropyl S-dicyclohexylammonium methylphosphonothiolate

Schedule: 2B04

CAS RN: HS code: 2930.90

Key: (75-84-3)-M2B41-S(101-83-7)

Molecular formula: C<sub>18</sub>H<sub>38</sub>NO<sub>2</sub>PS

CAS Index Name: Phosphonothioic acid, methyl-, O-(2,2-dimethylpropyl) ester, compd. with dicyclohexylamine

**IUPAC name:** N,N-Dicyclohexyl-S-[methyl(neopentyl)oxy]phosphoryl]thiohydroxylammonium

Synonyms: O-2,2-Dimethylpropyl methylphosphonothioic acid, dicyclohexylammonium salt

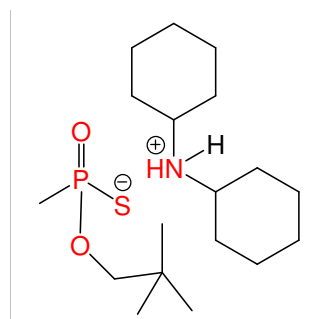

**Chemical name:** 2,2-Dimethylpropyl S-(N-ethylbenzenaminium) methylphosphonothiolate (-)

Schedule: 2B04

CAS RN: HS code: 2930.90

Key: (75-84-3)-M2B41-S(103-69-5)-(-)

Molecular formula: C<sub>6</sub>H<sub>14</sub>O<sub>2</sub>PS.C<sub>8</sub>H<sub>12</sub>N

CAS Index Name: Phosphonothioic acid, methyl-, O-(2,2-dimethylpropyl) ester N-ethylbenzenaminium salt, (-)

**IUPAC name:** N-ethylanilinium O-(2,2-dimethylpropyl) methylphosphonothioate(-)

Synonyms: N-Ethylbenzenaminium O-(2,2-dimethylpropyl) methylphosphonothiolate (-)  
N-Ethylbenzenaminium O-(2,2-dimethylpropyl) methylphosphonothioate (-)

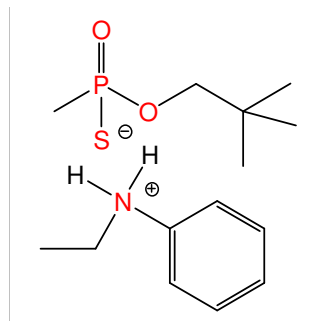

**Chemical name:** 2,2-Dimethylpropyl S-sodium methylphosphonothiolate

Schedule: 2B04

CAS RN: HS code: 2930.90

Key: (75-84-3)-M2B41-S(Na)

Molecular formula: C<sub>6</sub>H<sub>14</sub>NaO<sub>2</sub>PS

CAS Index Name: Phosphonothioic acid, methyl O-2,2-dimethylpropyl ester, sodium salt

**IUPAC name:** Sodium O-(2,2-dimethylpropyl) methylphosphonothioate

Synonyms:

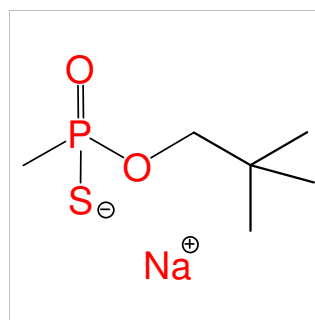

**Chemical name:** N-Dicyclohexylammonium O-2,2-dimethylpropyl methylphosphonothionate

Schedule: 2B04

CAS RN: HS code: 2930.90

Key: (75-84-3)-M2B45-O(101-83-7)

Molecular formula: C<sub>6</sub>H<sub>14</sub>O<sub>2</sub>PS.C<sub>12</sub>H<sub>24</sub>N

CAS Index Name: Phosphonothioic acid, methyl-, O-(2,2-dimethylpropyl) ester N-dicyclohexylammonium salt

**IUPAC name:** N-Dicyclohexylammonium O-(2,2-dimethylpropyl) methylphosphonothioate

Synonyms: O-2,2-Dimethylpropyl N-dicyclohexylammonium methylphosphonothionate  
2,2-Dimethylpropyl N-dicyclohexylammonium methylphosphonothionate

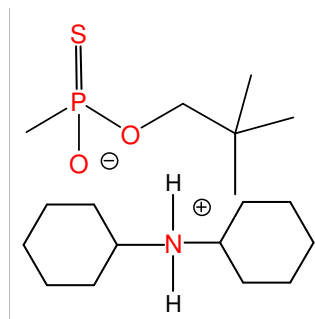

**Chemical name:** N-Ethylbenzenaminium O-2,2-dimethylpropyl methylphosphonothionate

Schedule: 2B04

CAS RN: HS code: 2930.90

Key: (75-84-3)-M2B45-O(103-69-5)

Molecular formula: C<sub>6</sub>H<sub>14</sub>O<sub>2</sub>PS.C<sub>8</sub>H<sub>12</sub>N

CAS Index Name: Phosphonothioic acid, methyl-, O-(2,2-dimethylpropyl) ester N-ethylbenzenaminium salt

**IUPAC name:** N-Ethylbenzenaminium O-2,2-dimethylpropyl methylphosphonothioate

Synonyms: N-Ethylbenzenaminium O-neopentyl methylphosphonothionate

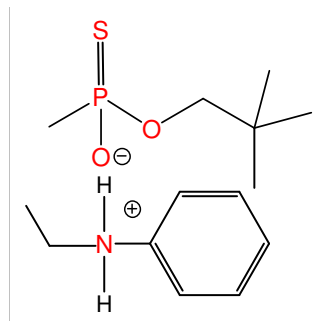

**Chemical name:** O-2,2-Dimethylpropyl O-sodium methylphosphonothionate

Schedule: 2B04

CAS RN: HS code: 2930.90

Key: (75-84-3)-M2B45-O(Na)

Molecular formula: C<sub>6</sub>H<sub>14</sub>NaO<sub>2</sub>PS

CAS Index Name: Phosphonothioic acid, methyl-, O-(2,2-dimethylpropyl) ester sodium salt

**IUPAC name:** Sodium O-2,2-dimethylpropyl methylphosphonothioate

Synonyms: Sodium O-neopentyl methylphosphonothionate

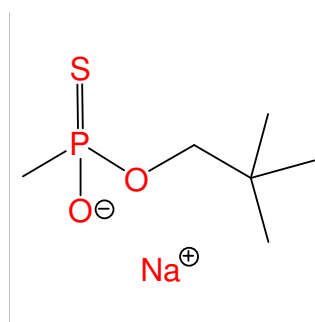

**Chemical name:** O-tert-Butyl methylmethylphosphonate

Schedule: 2B04

CAS RN: HS code: 2931.39

Key: (76-65-0)-M2B41

Molecular formula: C<sub>6</sub>H<sub>15</sub>O<sub>3</sub>P

CAS Index Name:

**IUPAC name:**

Synonyms: O-tert-Butyl methylphosphonic acid  
1,1-dimethylethyl methylphosphonate  
1,1-dimethylethyl methylphosphonic acid  
tert-butyl methylphosphonate

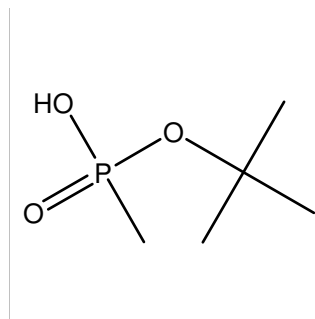

**Chemical name:** 1-Ethyl-1-methylpropyl pinacolyl methylphosphonate

Schedule: 2B04

CAS RN: HS code: 2931.39

Key: (77-74-7)-M2B41-(464-07-3)

Molecular formula: C<sub>13</sub>H<sub>29</sub>O<sub>3</sub>P

CAS Index Name: Phosphonic acid, methyl-, 1-ethyl-1-methylpropyl 1,2,2-trimethylpropyl ester

**IUPAC name:** 1-Ethyl-1-methylpropyl 1,2,2-trimethylpropyl methylphosphonate

Synonyms: O-(1,1-Diethylethyl) O-(1,2,2-trimethylpropyl) methylphosphonate

3-Methylpentan-3-yl pinacolyl methylphosphonate

3-Methylpentan-3-yl 3,3-dimethylbutan-2-yl methylphosphonate

3-Methylpentan-3-yl 1,2,2-trimethylpropyl methylphosphonate

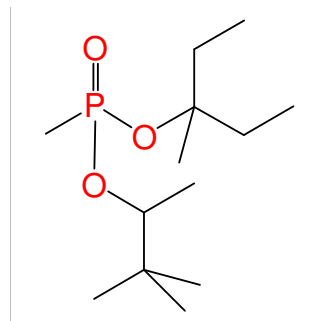

**Chemical name:** O-Isobutyl ethylphosphinothionate

Schedule: 2B04

CAS RN: HS code: 2930.90

Key: (78-83-1)-E2B45-H

Molecular formula: C<sub>6</sub>H<sub>15</sub>O<sub>2</sub>PS

CAS Index Name:

**IUPAC name:**

Synonyms:

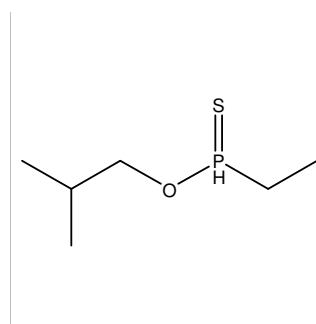

**Chemical name:** Isobutyl S-sodium isopropylphosphonothioate

Schedule: 2B04

CAS RN: HS code: 2930.90

Key: (78-83-1)-I2B41-S(Na)

Molecular formula: C<sub>7</sub>H<sub>16</sub>NaO<sub>2</sub>PS

CAS Index Name: Phosphonothioic acid, 1-methylethyl-, O-(2-methylpropyl) ester, sodium salt

**IUPAC name:** Sodium O-isobutyl isopropylphosphonothioate

Synonyms: Sodium O-(2-methylpropyl) isopropylphosphonothioate

Phosphonothioic acid, 1-methylethyl-, O-2-methylpropyl ester, sodium salt

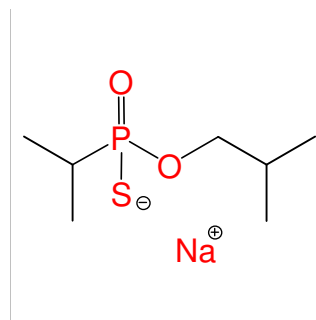

**Chemical name:** (R)-Isobutyl methyl methylphosphonate

Schedule: 2B04

CAS RN: HS code: 2931.39

Key: (78-83-1)-M2B41-(67-56-1)-(R)

Molecular formula: C<sub>6</sub>H<sub>15</sub>O<sub>3</sub>P

CAS Index Name:

**IUPAC name:**

Synonyms:

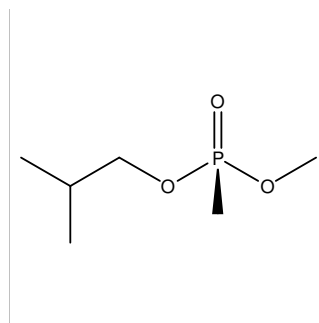

**Chemical name:** Isobutyl N-methyl-N-(2-hydroxyethyl) methylphosphonoamidate

Schedule: 2B04

CAS RN: HS code: 2931.39

Key: (78-83-1)-M2B41-N(67-56-1)(107-21-1)

Molecular formula: C<sub>8</sub>H<sub>20</sub>NO<sub>3</sub>P

CAS Index Name:

**IUPAC name:**

Synonyms:

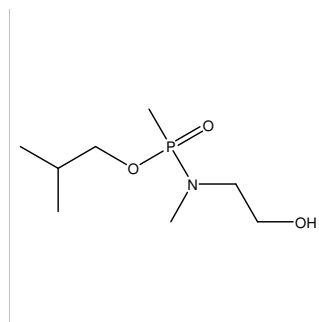

**Chemical name:** Isobutyl S-ammonium methylphosphonothiolate

Schedule: 2B04

CAS RN: HS code: 2930.90

Key: (78-83-1)-M2B41-S(NH<sub>4</sub>)

Molecular formula: C<sub>5</sub>H<sub>16</sub>NO<sub>2</sub>PS

CAS Index Name: Phosphonothioic acid, methyl-, O-(2-methylpropyl) ester, ammonium salt

**IUPAC name:** Ammonium O-(2-methylpropyl) methylphosphonothioate

Synonyms:

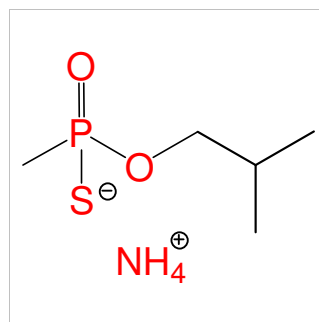

**Chemical name:** Isobutyl S-sodium propylphosphonothiolate

Schedule: 2B04

CAS RN: HS code: 2930.90

Key: (78-83-1)-P2B41-S(Na)

Molecular formula: C<sub>7</sub>H<sub>16</sub>NaO<sub>2</sub>PS

CAS Index Name: Phosphonothioic acid, propyl-, O-(2-methylpropyl) ester, sodium salt

**IUPAC name:** Sodium O-isobutyl propylphosphonothioate

Synonyms:

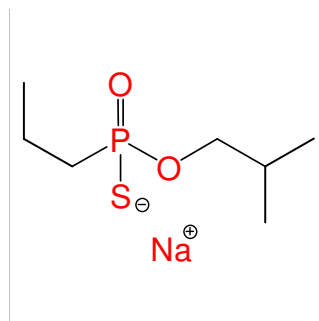

**Chemical name:** sec-Butyl S-sodium isopropylphosphonothiolate

Schedule: 2B04

CAS RN: HS code: 2930.90

Key: (78-92-2)-I2B41-S(Na)

Molecular formula: C<sub>7</sub>H<sub>16</sub>NaO<sub>2</sub>PS

CAS Index Name: Phosphonothioic acid, 1-methylethyl-, O-(1-methylpropyl) ester, sodium salt

**IUPAC name:** Sodium O-(sec-butyl) isopropylphosphonothioate

Synonyms: Sodium O-(sec-butyl) isopropylphosphonothiolate

Sodium O-(butan-2-yl) isopropylphosphonothiolate

Sodium O-(but-2-yl) isopropylphosphonothiolate

Sodium O-(1-methylpropyl) isopropylphosphonothiolate

Phosphonothioic acid, 1-methylethyl-, O-1-methylpropyl ester, sodium salt

1-Methylpropyl S-sodium isopropylphosphonothiolate

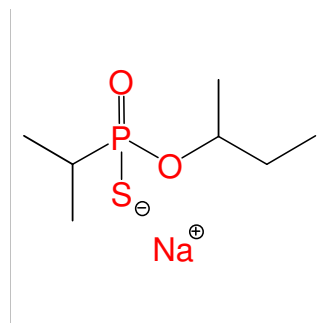

**Chemical name:** sec-Butyl methylphosphonate

Schedule: 2B04

CAS RN: HS code: 2931.39

Key: (78-92-2)-M2B41

Molecular formula: C<sub>5</sub>H<sub>13</sub>O<sub>3</sub>P

CAS Index Name: Phosphonic acid, methyl-, mono(1-methylpropyl) ester

**IUPAC name:** sec-Butyl methylphosphonate

Synonyms: Butan-2-yl methylphosphonate

1-Methylpropyl methylphosphonate

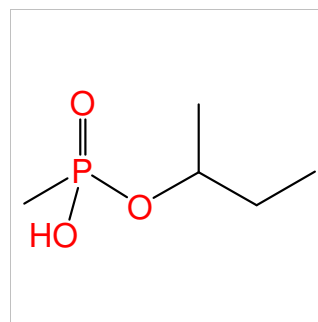

**Chemical name:** Bis(1-methylpropyl) ethylphosphonate

Schedule: 2B04

CAS RN: HS code: 2931.39

Key: (78-92-2)-M2B41-(78-92-2)

Molecular formula: C<sub>9</sub>H<sub>21</sub>O<sub>3</sub>P

CAS Index Name: Phosphonic acid, ethyl-, bis(1-methylpropyl) ester

**IUPAC name:** Bis(1-methylpropyl) ethylphosphonate

Synonyms:

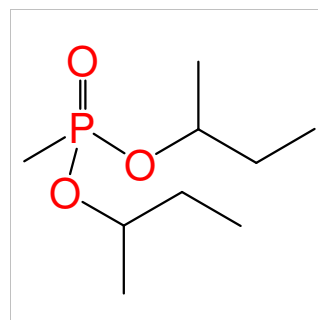

**Chemical name:** sec-Butyl S-sodium methylphosphonothiolate

Schedule: 2B04

CAS RN: HS code: 2930.90

Key: (78-92-2)-M2B41-S(Na)

Molecular formula: C<sub>5</sub>H<sub>12</sub>NaO<sub>2</sub>PS

CAS Index Name: Phosphonothioic acid, methyl-, O-(1-methylpropyl) ester, sodium salt

**IUPAC name:** Sodium O-sec-butyl methylphosphonothioate

Synonyms: Sodium O-(butan-2-yl) methylphosphonothiolate

Sodium O-(but-2-yl) methylphosphonothiolate

Sodium O-(1-methylpropyl) methylphosphonothiolate

O-sec-Butyl S-sodium methylphosphonothiolate

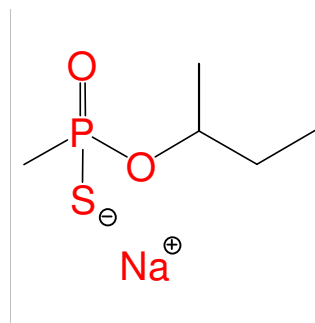

**Chemical name:** O-(1-Methylpropyl) methylphosphonothionate

Schedule: 2B04

CAS RN: HS code: 2930.90

Key: (78-92-2)-M2B45

Molecular formula: C<sub>5</sub>H<sub>13</sub>O<sub>2</sub>PS

CAS Index Name: Phosphonothioic acid, methyl-, O-(1-methylpropyl) ester

**IUPAC name:** O-(1-Methylpropyl) methylphosphonothioate

Synonyms: O-(Butan-2-yl) methylphosphonothionate

O-(But-2-yl) methylphosphonothionate

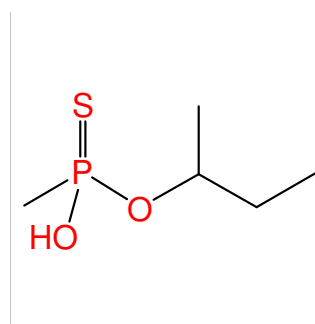

**Chemical name:** O,O-Bis(1-methylpropyl) methylphosphonothionate

Schedule: 2B04

CAS RN: HS code: 2930.90

Key: (78-92-2)-M2B45-(78-92-2)

Molecular formula: C<sub>9</sub>H<sub>21</sub>O<sub>2</sub>PS

CAS Index Name: Phosphonothioic acid, methyl-, O,O-bis(1-methylpropyl) ester

**IUPAC name:** O,O-Bis(1-methylpropyl) methylphosphonothioate

Synonyms: O,O-Bis(butan-2-yl) methylphosphonothionate

O,O-Bis(but-2-yl) methylphosphonothionate

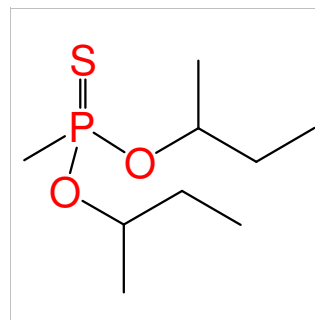

**Chemical name:** sec-Butyl S-sodium propylphosphonothiolate

Schedule: 2B04

CAS RN: HS code: 2930.90

Key: (78-92-2)-P2B41-S(Na)

Molecular formula: C<sub>7</sub>H<sub>16</sub>NaO<sub>2</sub>PS

CAS Index Name: Phosphonothioic acid, propyl-, O-(1-methylpropyl) ester, sodium salt

**IUPAC name:** Sodium O-(sec-butyl) propylphosphonothioate

Synonyms: Sodium O-(1-methylpropyl) propylphosphonothiolate

Butan-2-yl S-sodium propylphosphonothiolate

But-2-yl S-sodium propylphosphonothiolate

1-Methylpropyl S-sodium propylphosphonothiolate

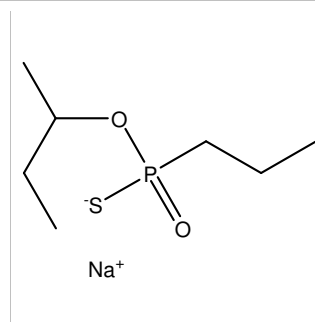

**Chemical name:** Cyclopentyl methylphosphonochloridate

Schedule: 2B04

CAS RN: HS code: 2931.39

Key: (96-41-3)-M2B41-Cl

Molecular formula: C<sub>6</sub>H<sub>12</sub>ClO<sub>2</sub>P

CAS Index Name: Phosphonochloridic acid, methyl-, cyclopentyl ester

**IUPAC name:** Cyclopentyl methylphosphonochloridoate

Synonyms:

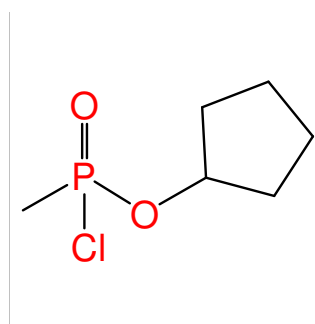

**Chemical name:** Cyclopentyl S-ethyl methylphosphonothiolate

Schedule: 2B04

CAS RN: HS code: 2930.90

Key: (96-41-3)-M2B41-S(64-17-5)

Molecular formula: C<sub>8</sub>H<sub>17</sub>O<sub>2</sub>PS

CAS Index Name: Phosphonothioic acid, methyl-, O-cyclopentyl S-ethyl ester

**IUPAC name:** Cyclopentyl S-ethyl methylphosphonothioate

Synonyms: O-Cyclopentyl S-ethyl methylphosphonothiolate

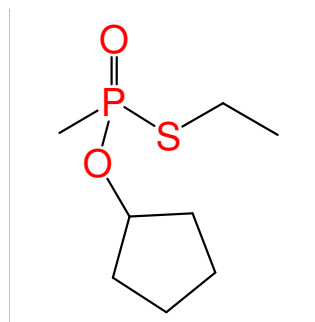



**Chemical name:** Cyclopentyl S-sodium methylphosphonothiolate

Schedule: 2B04

CAS RN: HS code: 2930.90

Key: (96-41-3)-M2B41-S(Na)

Molecular formula: C<sub>6</sub>H<sub>12</sub>NaO<sub>2</sub>PS

CAS Index Name: Phosphonothioic acid, methyl-, O-cyclopentyl ester, sodium salt

**IUPAC name:** Sodium O-cyclopentyl methylphosphonothioate

Synonyms:

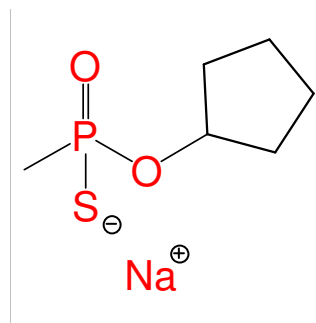

**Chemical name:** O-Cyclopentyl methylphosphonothionochloridate

Schedule: 2B04

CAS RN: HS code: 2930.90

Key: (96-41-3)-M2B42-Cl

Molecular formula: C<sub>6</sub>H<sub>12</sub>ClOPS

CAS Index Name:

**IUPAC name:**

Synonyms: Cyclopentyl methylphosphonothioic chloride

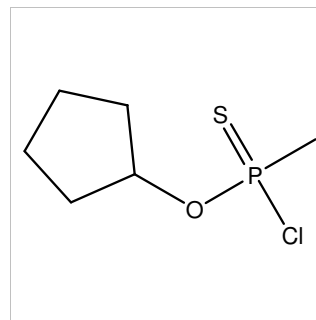

**Chemical name:** O-Cyclopentyl O-ethyl methylphosphonothionate

Schedule: 2B04

CAS RN: HS code: 2930.90

Key: (96-41-3)-M2B45-(64-17-5)

Molecular formula: C<sub>8</sub>H<sub>17</sub>O<sub>2</sub>PS

CAS Index Name: Phosphonothioic acid, methyl-, O-cyclopentyl O-ethyl ester

**IUPAC name:** O-Cyclopentyl O-ethyl methylphosphonothioate

Synonyms:

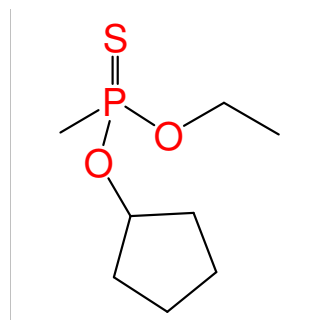

**Chemical name:** O,O-Dicyclopentyl methylphosphonothionate

Schedule: 2B04

CAS RN: HS code: 2930.90

Key: (96-41-3)-M2B45-(96-41-3)

Molecular formula: C<sub>11</sub>H<sub>21</sub>O<sub>2</sub>PS

CAS Index Name:

**IUPAC name:**

Synonyms: Dicyclopentyl methylphosphonothioate

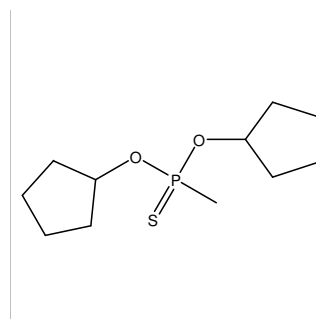

**Chemical name:** O-2-Ethylbutyl O-sodium ethylphosphonothionate

Schedule: 2B04

CAS RN: HS code: 2930.90

Key: (97-95-0)-E2B45-O(Na)

Molecular formula: C<sub>8</sub>H<sub>18</sub>NaO<sub>2</sub>PS

CAS Index Name: Phosphonothioic acid, ethyl-, O-(2-ethylbutyl) ester sodium salt

**IUPAC name:** Sodium O-(2-ethylbutyl) ethylphosphonothioate

Synonyms: Sodium O-(2-ethylbutyl) ethylphosphonothionate

O-Pentan-3-yl O-sodium ethylphosphonothionate

O-Pent-3-yl O-sodium ethylphosphonothionate

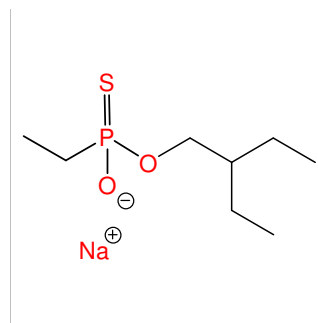

**Chemical name:** 2-Ethylbutyl methylphosphonate

Schedule: 2B04

CAS RN: HS code: 2931.39

Key: (97-95-0)-M2B41

Molecular formula: C<sub>7</sub>H<sub>17</sub>O<sub>3</sub>P

CAS Index Name: Phosphonic acid, methyl-, mono(2-ethylbutyl) ester

**IUPAC name:** 2-Ethylbutyl methylphosphonate

Synonyms: O-(2-Ethylbutyl) methylphosphonate

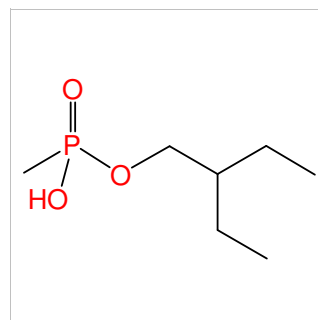

**Chemical name:** 2-Ethylbutyl pinacolyl methylphosphonate

Schedule: 2B04

CAS RN: HS code: 2931.39

Key: (97-95-0)-M2B41-(464-07-3)

Molecular formula: C<sub>13</sub>H<sub>29</sub>O<sub>3</sub>P

CAS Index Name: Phosphonic acid, methyl-, 2-ethylbutyl 1,2,2-trimethylpropyl ester

**IUPAC name:** 2-Ethylbutyl 1,2,2-trimethylpropyl methylphosphonate

Synonyms: O-(2-Ethylbutyl) O-(1,2,2-trimethylpropyl) methylphosphonate

3,3-Dimethylbutan-2-yl 2-ethylbutyl methylphosphonate

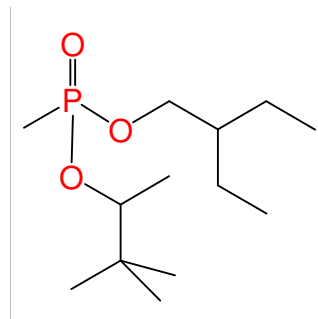

**Chemical name:** 1,2-Dimethyl-2-methoxypropyl  
methylphosphonofluoridate

Schedule: 2B04

CAS RN: HS code: 2931.39

Key: (ID4230)-M2B41-SH

Molecular formula: C<sub>7</sub>H<sub>16</sub>FO<sub>3</sub>P

CAS Index Name:

**IUPAC name:**

Synonyms:

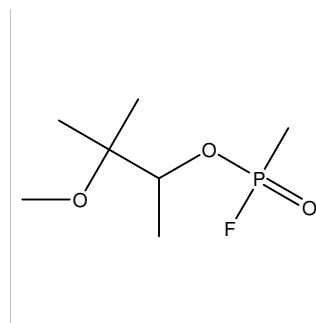

**Chemical name:** Methylphosphonic diamide dihydrochloride

Schedule: 2B04

CAS RN: HS code: 2931.39

Key: (NH<sub>3</sub>Cl)-M2B41-(NH<sub>3</sub>Cl)

Molecular formula: CH<sub>9</sub>Cl<sub>2</sub>N<sub>2</sub>OP

CAS Index Name: Methylphosphonic diamide, N,N-dichloro-

**IUPAC name:** N,N'-Dichloro-P-methylphosphonic diamide

Synonyms: Methylphosphonic diamide, bis(ammonium chloride) salt  
methylphosphanediaminium oxide dichloride  
chlorammonium salt of diamidomethylphosphonic acid

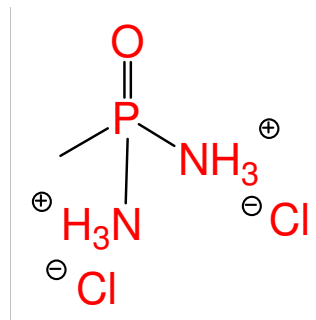

**Chemical name:** Phosphonic acid, ethyl-, polyglycol ester

Schedule: 2B04

CAS RN: HS code:

Key: (R<sub>m</sub>)-E2B41-(R<sub>n</sub>)

Molecular formula: Unspecified

CAS Index Name: Phosphonic acid, ethyl-, polyglycol ester

**IUPAC name:**

Synonyms:

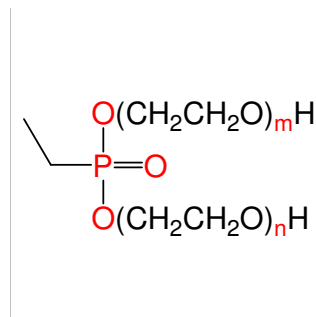

**Chemical name:** Bis(2-diethylaminoethyl) ethylphosphonate

Schedule: 2B04

CAS RN: 101098-30-0 HS code: 2931.90

Key: 101098-30-0

Molecular formula: C<sub>14</sub>H<sub>33</sub>N<sub>2</sub>O<sub>3</sub>P

CAS Index Name: Phosphonic acid, ethyl-, bis(2-diethylaminoethyl) ester

**IUPAC name:**

Synonyms:

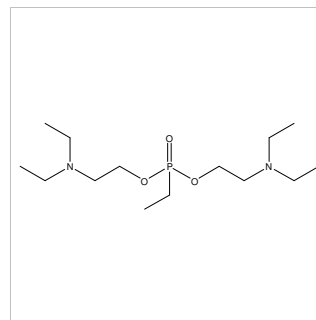

**Chemical name:** Bis(1-methylpentyl) methylphosphonate

Schedule: 2B04

CAS RN: 1020119-28-1

HS code: 2931.39

Key: 1020119-28-1

Molecular formula: C<sub>13</sub>H<sub>29</sub>O<sub>3</sub>P

CAS Index Name: Phosphonic acid, methyl-, bis(1-methylpentyl) ester

**IUPAC name:** Bis(1-methylpentyl) methylphosphonate

Synonyms: Bis(hexan-2-yl) methylphosphonate

Bis(hex-2-yl) methylphosphonate

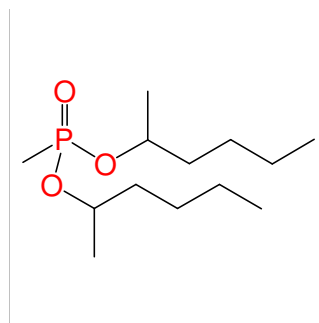

**Chemical name:** Methyl(d<sub>3</sub>) phosphonic acid

Schedule: 2B04

CAS RN: 104801-16-3

HS code: 2845.90

Key: 104801-16-3

Molecular formula: C H<sub>2</sub> D<sub>3</sub> O<sub>3</sub> P

CAS Index Name: Phosphonic acid, methyl-d<sub>3</sub>-

**IUPAC name:**

Synonyms:

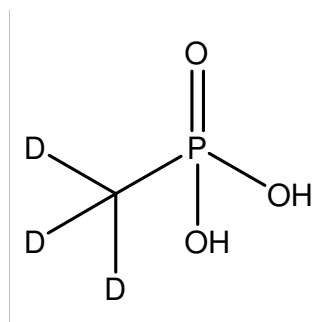

**Chemical name:** Methyl-d<sub>3</sub>-phosphonic dichloride

Schedule: 2B04

CAS RN: 104801-17-4

HS code: 2845.90

Key: 104801-17-4

Molecular formula: CD<sub>3</sub>Cl<sub>2</sub>OP

CAS Index Name: Phosphonic dichloride, methyl-d<sub>3</sub>-

**IUPAC name:** (d<sub>3</sub>)Methylphosphonic dichloride

Synonyms: Trideuteriomethylphosphonic dichloride

(<sup>2</sup>H<sub>3</sub>)Methylphosphonic dichloride

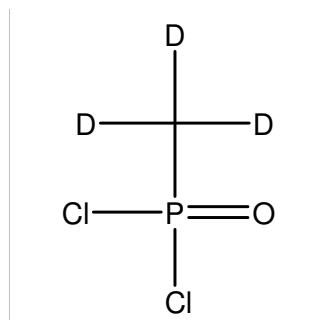

**Chemical name:** O,O-Bis(1-methylpropyl) methylphosphonate

Schedule: 2B04

CAS RN: 105263-11-4

HS code: 2931.39

Key: 105263-11-4

Molecular formula: C<sub>9</sub>H<sub>21</sub>O<sub>3</sub>P

CAS Index Name: Phosphonic acid, methyl-, bis(1-methylpropyl) ester, (R\*,R\*)- (9CI)

**IUPAC name:**

Synonyms: Phosphonic acid, methyl-, bis(1-methylpropyl) ester, (R\*,R\*)- (+/-)-

O,O-Diisobutyl methylphosphonate

Diisobutyl methylphosphonate

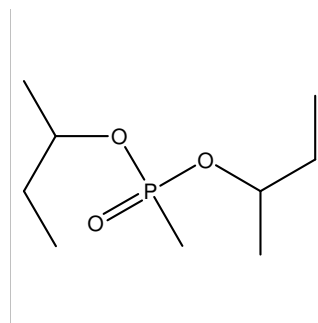

**Chemical name:** Ethylphosphonic dichloride

Schedule: 2B04

CAS RN: 1066-50-8

HS code: 2931.39

Key: 1066-50-8

Molecular formula: C<sub>2</sub>H<sub>5</sub>Cl<sub>2</sub>OP

CAS Index Name: Phosphonic dichloride, ethyl-

**IUPAC name:** Ethylphosphonic dichloride

Synonyms: Ethylphosphonyl dichloride

Ethylphosphonic acid dichloride

Ethanephosphonyl chloride

Dichloroethylphosphine oxide

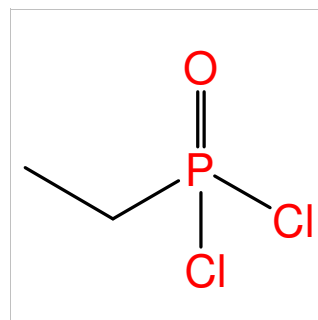

**Chemical name:** Methyl methylphosphonochloridate

Schedule: 2B04

CAS RN: 1066-52-0

HS code: 2931.39

Key: 1066-52-0

Molecular formula: C<sub>2</sub>H<sub>6</sub>ClO<sub>2</sub>P

CAS Index Name: Phosphonochloridic acid, P-methyl-, methyl ester

**IUPAC name:** Methyl methylphosphonochloridoate

Synonyms: Phosphonochloridic acid, methyl-, methyl ester

Methyl methylphosphonochloridate

Methyl methylchlorophosphonate

Methyl methanephosphonochloridate

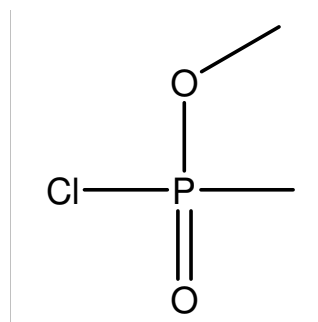

**Chemical name:** Methyl methylphosphonate

Schedule: 2B04

CAS RN: 1066-53-1

HS code: 2931.39

Key: 1066-53-1

Molecular formula: C<sub>2</sub>H<sub>7</sub>O<sub>3</sub>P

CAS Index Name: Phosphonic acid, methyl-, monomethyl ester

**IUPAC name:** Methyl methylphosphonate

Synonyms: Phosphonic acid, methyl-, methyl ester

Methyl phosphonic acid monomethyl ester

Methyl methanephosphonate

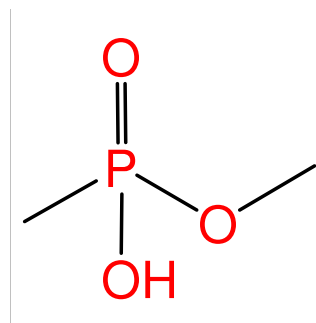

**Chemical name:** Diisopropyl ethylphosphonate

Schedule: 2B04

CAS RN: 1067-69-2

HS code: 2931.39

Key: 1067-69-2

Molecular formula: C<sub>8</sub>H<sub>19</sub>O<sub>3</sub>P

CAS Index Name: Phosphonic acid, ethyl-, bis(1-methylethyl) ester

**IUPAC name:** Diisopropyl ethylphosphonate

Synonyms: O,O-Diisopropyl ethylphosphonate

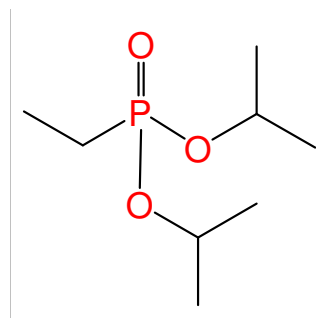

**Chemical name:** Octyl isopropylphosphonate

Schedule: 2B04

CAS RN: 108506-63-4

HS code: 2931.39

Key: 108506-63-4

Molecular formula: C<sub>11</sub>H<sub>25</sub>O<sub>3</sub>P

CAS Index Name: Phosphonic acid, (1-methylethyl)-, mono-octyl ester

**IUPAC name:** Octyl isopropylphosphonate

Synonyms:

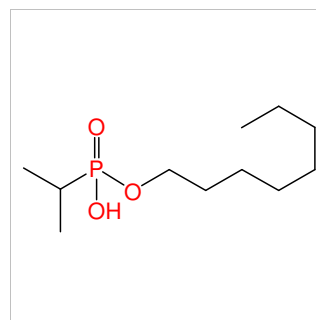

**Chemical name:** Diisopropyl d<sub>3</sub>-methylphosphonate

Schedule: 2B04

CAS RN: 113579-13-8

HS code: 2845.90

Key: 113579-13-8

Molecular formula: C<sub>7</sub>H<sub>14</sub>D<sub>3</sub>O<sub>3</sub>P

CAS Index Name: Phosphonic acid, P-(methyl-d<sub>3</sub>)-, bis(1-methylethyl) ester

**IUPAC name:**

Synonyms:

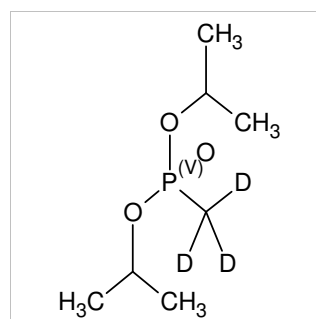

**Chemical name:** Aluminium methyl propylphosphonate

Schedule: 2B04

CAS RN: 114076-21-0

HS code: 2931.39

Key: 114076-21-0

Molecular formula: C<sub>4</sub>H<sub>10</sub>O<sub>3</sub>P.1/3Al

CAS Index Name: Phosphonic acid, propyl-, monomethyl ester, aluminium salt

**IUPAC name:** Aluminium methyl propylphosphonate

Synonyms:

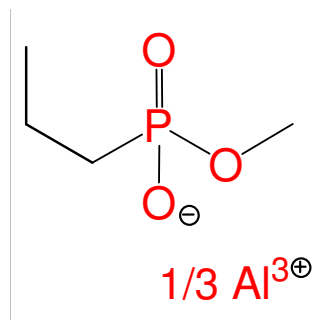

**Chemical name:** O-Pinacolyl S-sodium methylphosphonothiolate

Schedule: 2B04

CAS RN: 116498-77-2

HS code: 2930.90

Key: 116498-77-2

Molecular formula: C<sub>7</sub>H<sub>16</sub>NaO<sub>2</sub>PS

CAS Index Name: Phosphonothioic acid, methyl-, O-(1,2,2-trimethylpropyl) ester, sodium salt

**IUPAC name:**

Synonyms:

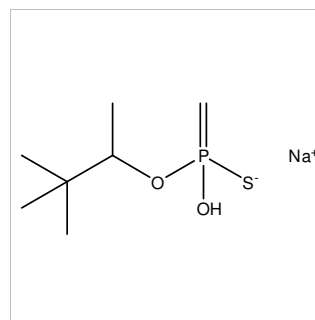

**Chemical name:** Ethyl S-sodium propylphosphonothiolate

Schedule: 2B04

CAS RN: 117122-90-4

HS code: 2930.90

Key: 117122-90-4

Molecular formula: C<sub>5</sub>H<sub>12</sub>NaO<sub>2</sub>PS

CAS Index Name: Phosphonothioic acid, propyl-, O-ethyl ester, sodium salt

**IUPAC name:** Sodium O-ethyl propylphosphonothioate

Synonyms: Sodium O-ethyl propylphosphonothiolate

O-Ethyl S-sodium propylphosphonothiolate

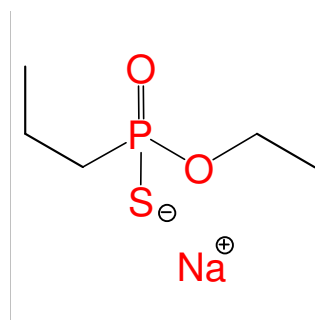

**Chemical name:** di-d7-isopropyl methylphosphonate

Schedule: 2B04

CAS RN: 1205608-66-7

HS code: 2845.90

Key: 1205608-66-7

Molecular formula: C<sub>7</sub>H<sub>3</sub>D<sub>14</sub>O<sub>3</sub>P

CAS Index Name: Phosphonic acid, P-methyl-, bis[1-(methyl-d3)ethyl-1,2,2,2-d4] ester

**IUPAC name:**

Synonyms:

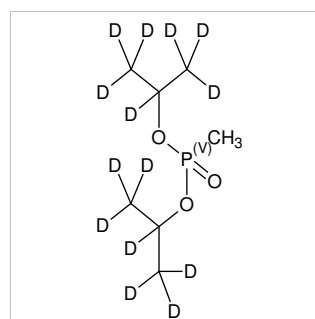

**Chemical name:** O-Isopropyl isopropylphosphonothiolate

Schedule: 2B04

CAS RN: 1256698-27-7

HS code: 2930.90

Key: 1256698-27-7

Molecular formula: C<sub>6</sub> H<sub>15</sub> O<sub>2</sub> P S

CAS Index Name: Phosphonothioic acid, P-(1-methylethyl)-, O-(1-methylethyl) ester

**IUPAC name:**

Synonyms:

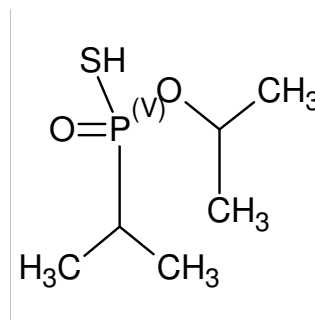

**Chemical name:** Diethyl methyl(d<sub>3</sub>)phosphonate

Schedule: 2B04

CAS RN: 128478-92-2

HS code: 2845.90

Key: 128478-92-2

Molecular formula: C<sub>5</sub>H<sub>10</sub>D<sub>3</sub>O<sub>3</sub>P

CAS Index Name: Phosphonic acid, methyl-d<sub>3</sub>-, diethyl ester

**IUPAC name:**

Synonyms:

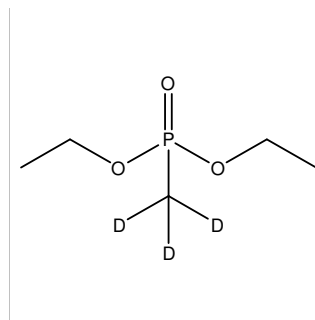

**Chemical name:** Product from the reaction of Methylphosphonic acid and 1,3,5-Triazine-2,4,6-triamine

Schedule: 2B04

CAS RN: 129788-86-9

HS code:

Key: 129788-86-9

Molecular formula: C<sub>3</sub>H<sub>6</sub>N<sub>6</sub>.CH<sub>5</sub>O<sub>3</sub>P

CAS Index Name: Phosphonic acid, P-methyl-, compd. with 1,3,5-triazine-2,4,6-triamine (1:1)

**IUPAC name:**

Synonyms:

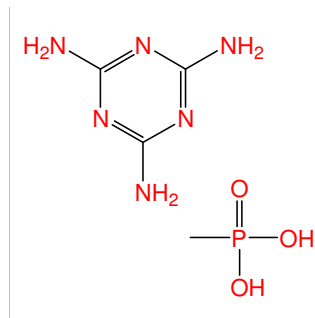

**Chemical name:** S-Methyl methylphosphonochloridothiolate

Schedule: 2B04

CAS RN: 13113-89-8

HS code: 2930.90

Key: 13113-89-8

Molecular formula: C<sub>2</sub>H<sub>6</sub>ClOPS

CAS Index Name: Phosphonochloridothioic acid, methyl-, S-methyl ester

**IUPAC name:** S-Methyl methylphosphonochloridothioate

Synonyms:

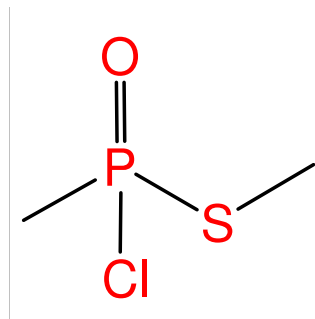



**Chemical name:** Isobutyl propylphosphonochloridate

Schedule: 2B04

CAS RN: 13213-47-3

HS code: 2931.39

Key: 13213-47-3

Molecular formula: C<sub>7</sub>H<sub>16</sub>ClO<sub>2</sub>P

CAS Index Name: Phosphonochloridic acid, propyl-, 2-methylpropyl ester

**IUPAC name:** Isobutyl propylphosphonochloridoate

Synonyms: O-Isobutyl propylphosphonochloridate

2-Methylpropyl propylphosphonochloridate

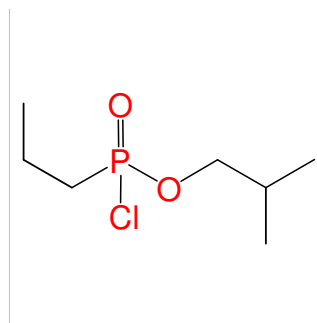

**Chemical name:** Phenyl methylphosphonofluoridate

Schedule: 2B04

CAS RN: 133826-40-1

HS code: 2931.39

Key: 133826-40-1

Molecular formula: C<sub>7</sub>H<sub>8</sub>FO<sub>2</sub>P

CAS Index Name: Phosphonofluoridic acid, methyl-, phenyl ester

**IUPAC name:** Phenyl methylphosphonofluoridoate

Synonyms: O-Phenyl methylphosphonofluoridate

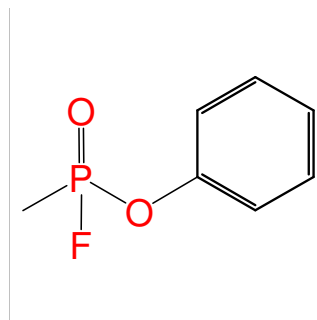

**Chemical name:** (S)-Potassium ethyl methylphosphonothiolate

Schedule: 2B04

CAS RN: 134496-36-9

HS code: 2930.90

Key: 134496-36-9

Molecular formula: C<sub>3</sub>H<sub>8</sub>O<sub>2</sub>PS.K

CAS Index Name: Phosphonothioic acid, methyl-, O-ethyl ester, potassium salt, (S)- (9CI)

**IUPAC name:**

Synonyms:

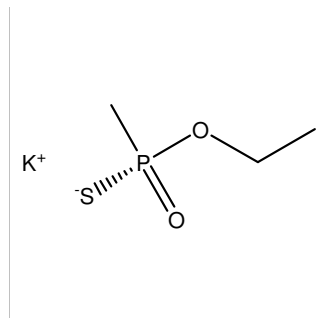

**Chemical name:** 2-Ethylhexyl methylphosphonate

Schedule: 2B04

CAS RN: 13688-82-9

HS code: 2931.39

Key: 13688-82-9

Molecular formula: C<sub>9</sub>H<sub>21</sub>O<sub>3</sub>P

CAS Index Name: Phosphonic acid, methyl-, 2-ethylhexyl ester

**IUPAC name:** 2-Ethylhexyl methylphosphonate

Synonyms: Methyl phosphonic acid 2-ethylhexyl ester

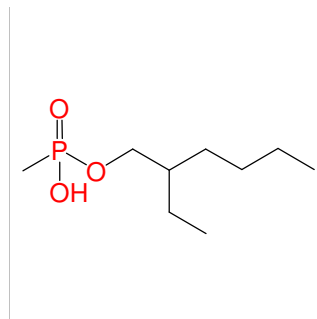

**Chemical name:** 2-Butenyl methylphosphonofluoridate

Schedule: 2B04

CAS RN: 138780-00-4

HS code: 2931.39

Key: 138780-00-4

Molecular formula: C<sub>5</sub>H<sub>10</sub>FO<sub>2</sub>P

CAS Index Name: Phosphonofluoridic acid, methyl-, 2-butenyl ester, (E)-

**IUPAC name:** (E)-2-Butenyl methylphosphonofluoridoate

Synonyms: trans-Crotylsarin

O-(E)-2-Butenyl methylphosphonofluoridate

(E)-2-Butenyl methylphosphonofluoridate

(2E)-But-2-enyl methylphosphonofluoridate

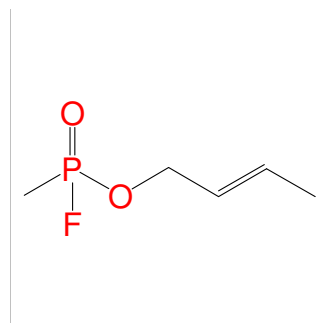

**Chemical name:** Ethylphosphonothioic acid

Schedule: 2B04

CAS RN: 13991-98-5

HS code: 2930.90

Key: 13991-98-5

Molecular formula: C<sub>2</sub>H<sub>7</sub>O<sub>2</sub>PS

CAS Index Name: Phosphonothioic acid, ethyl-

**IUPAC name:** Ethylphosphonothioic O,O-acid

Synonyms: Ethanephosphonic acid, thio-

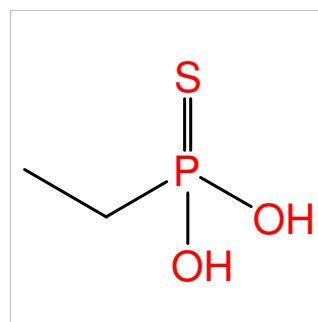

**Chemical name:** 2-Propenoic acid, 2-methyl-, (methylphosphinylidene)bis[oxy[2-(chloromethyl)-2,1-ethanediyl]] ester

Schedule: 2B04

CAS RN: 141032-95-3

HS code: 2931.39

Key: 141032-95-3

Molecular formula: C<sub>15</sub>H<sub>23</sub>Cl<sub>2</sub>O<sub>7</sub>P

CAS Index Name: 2-Propenoic acid, 2-methyl-, (methylphosphinylidene)bis[oxy[2-(chloromethyl)-2,1-ethanediyl]] ester

**IUPAC name:**

Synonyms:

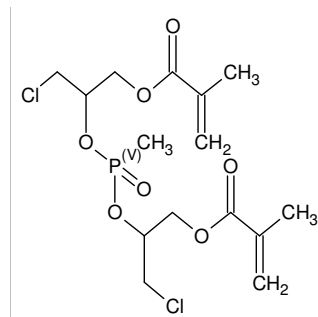

**Chemical name:** Methylphosphonic anhydride with melamin

Schedule: 2B04

CAS RN: 1423010-09-6

HS code: 2931.39

Key: 1423010-09-6

Molecular formula: C<sub>3</sub>H<sub>6</sub>N<sub>6</sub> . 1/2 C<sub>2</sub>H<sub>8</sub>O<sub>5</sub>P<sub>2</sub>

CAS Index Name: Diphosphonic acid, P,P'-dimethyl-, compd. with 1,3,5-triazine-2,4,6-triamine (1:2)

**IUPAC name:**

Synonyms:

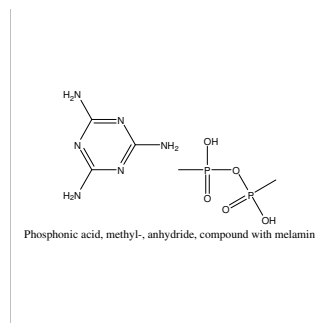

**Chemical name:** Pinacolyl ethylphosphonate

Schedule: 2B04

CAS RN: 143663-83-6

HS code: 2931.39

Key: 143663-83-6

Molecular formula: C<sub>8</sub>H<sub>19</sub>O<sub>3</sub>P

CAS Index Name: Phosphonic acid, ethyl-, mono(1,2,2-trimethylpropyl) ester

**IUPAC name:** 1,2,2-Trimethylpropyl ethylphosphonate

Synonyms: O-Pinacolyl ethylphosphonate

3,3-Dimethylbutan-2-yl ethylphosphonate

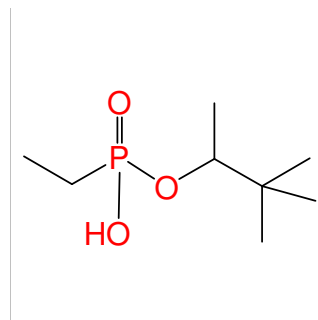

**Chemical name:** Methyl propyl ethylphosphonothionate

Schedule: 2B04

CAS RN: 1442476-06-3

HS code: 2930.90

Key: 1442476-06-3

Molecular formula: C<sub>6</sub> H<sub>15</sub> O<sub>2</sub> P S

CAS Index Name: Phosphonothioic acid, P-ethyl-, O-methyl O-propyl ester

**IUPAC name:**

Synonyms:

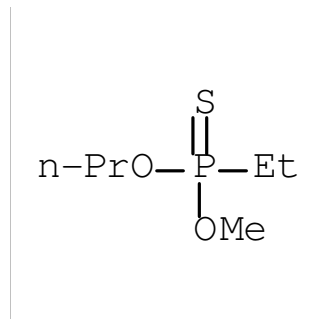

**Chemical name:** Diisopropyl methylphosphonate

Schedule: 2B04

CAS RN: 1445-75-6

HS code: 2931.39

Key: 1445-75-6

Molecular formula: C<sub>7</sub>H<sub>17</sub>O<sub>3</sub>P

CAS Index Name: Phosphonic acid, methyl-, bis(1-methylethyl) ester

**IUPAC name:** Diisopropyl methylphosphonate

Synonyms: Phosphonic acid, methyl-, diisopropyl ester

O,O-Diisopropyl methylphosphonate

DIMP (phosphonate)

DIMP

Diisopropyl methanephosphonate

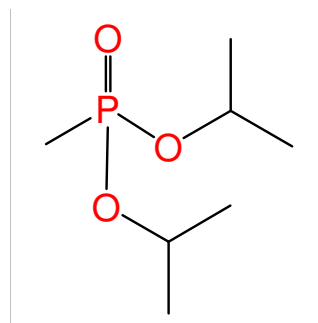

**Chemical name:** Benzyl methylphosphonofluoridate

Schedule: 2B04

CAS RN: 14618-07-6

HS code: 2931.39

Key: 14618-07-6

Molecular formula: C<sub>8</sub>H<sub>10</sub>FO<sub>2</sub>P

CAS Index Name: Phosphonofluoridic acid, methyl-, phenylmethyl ester

**IUPAC name:** Benzyl methylphosphonofluoridate

Synonyms: Phosphonofluoridic acid, methyl-, benzyl ester

Benzyl methylphosphonofluoridate

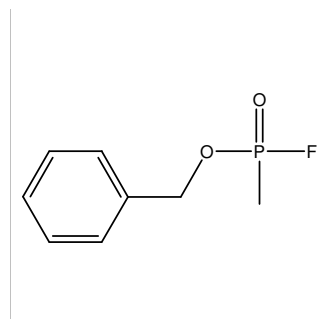

**Chemical name:** 1-Methylheptyl methylphosphonate

Schedule: 2B04

CAS RN: 148456-51-3

HS code: 2931.39

Key: 148456-51-3

Molecular formula: C<sub>9</sub>H<sub>21</sub>O<sub>3</sub>P

CAS Index Name: Phosphonic acid, methyl-, mono(1-methylheptyl) ester

**IUPAC name:** 1-Methylheptyl methylphosphonate

Synonyms: Octan-2-yl methylphosphonate

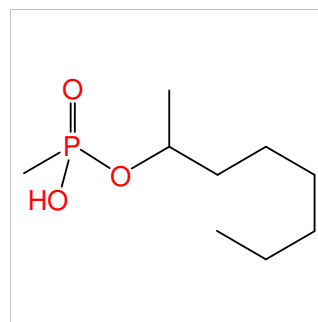

**Chemical name:** Dihexyl isopropylphosphonate

Schedule: 2B04

CAS RN: 148456-62-6

HS code: 2931.39

Key: 148456-62-6

Molecular formula: C<sub>15</sub>H<sub>33</sub>O<sub>3</sub>P

CAS Index Name: Phosphonic acid, (1-methylethyl)-, dihexyl ester

**IUPAC name:** Dihexyl isopropylphosphonate

Synonyms: O,O-Dihexyl isopropylphosphonate

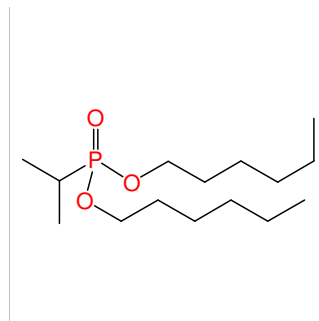

**Chemical name:** Hexyl methylphosphonate

Schedule: 2B04

CAS RN: 148456-69-3

HS code: 2931.39

Key: 148456-69-3

Molecular formula: C<sub>7</sub>H<sub>17</sub>O<sub>3</sub>P

CAS Index Name: Phosphonic acid, methyl-, monohexyl ester

**IUPAC name:** Hexyl methylphosphonate

Synonyms:

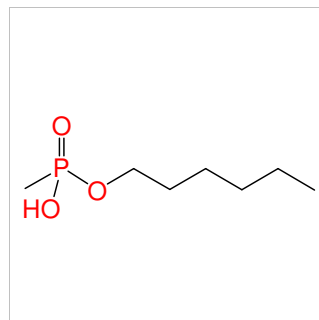

**Chemical name:** Methylphosphine borane

Schedule: 2B04

CAS RN: 14975-23-6

HS code: 2931.39

Key: 14975-23-6

Molecular formula: CH<sub>8</sub>BP

CAS Index Name: Boron, trihydro(methylphosphine)-, (T-4)-

**IUPAC name:** Boranylidene methylphosphanium

Synonyms: Trihydro(methylphosphine)boron  
(Methylphosphonio)trihydroborate

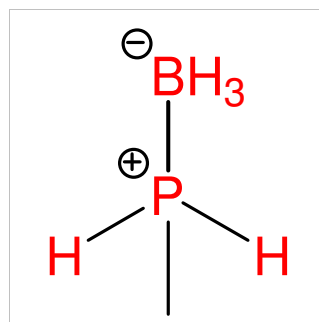

**Chemical name:** O-Ethyl ethylphosphonothionochloridate

Schedule: 2B04

CAS RN: 1497-68-3

HS code: 2931.39

Key: 1497-68-3

Molecular formula: C<sub>4</sub>H<sub>10</sub>ClOPS

CAS Index Name: Phosphonochloridothioic acid, ethyl-, O-ethyl ester

**IUPAC name:** O-Ethyl ethylphosphonochloridothioate

Synonyms: O-Ethyl ethylthiophosphonyl chloride

O-Ethyl ethanephosphonothionochloridate

Ethylthionophosphonic acid O-ethyl ester chloride

Ethyl ethylphosphonochloridothionate

Ethyl ethylphosphonochloridothioate

Ethanephosphonochloridothioic acid, O-ethyl ester

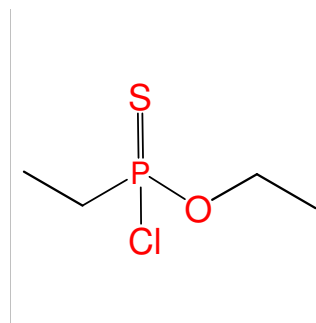

**Chemical name:** O-Methyl ethylphosphonothionochloridate

Schedule: 2B04

CAS RN: 1497-69-4

HS code: 2931.39

Key: 1497-69-4

Molecular formula: C<sub>3</sub>H<sub>8</sub>ClOPS

CAS Index Name: Phosphonochloridothioic acid, ethyl-, O-methyl ester

**IUPAC name:** O-Methyl ethylphosphonochloridothioate

Synonyms: O-Methyl ethanephosphonothionochloridate

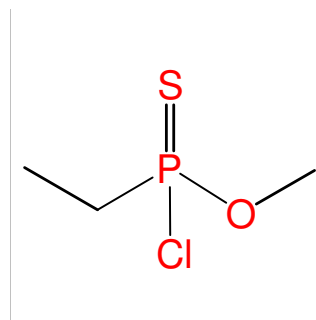

**Chemical name:** Ethylphosphonous dichloride

Schedule: 2B04

CAS RN: 1498-40-4

HS code: 2931.39

Key: 1498-40-4

Molecular formula: C<sub>2</sub>H<sub>5</sub>Cl<sub>2</sub>P

CAS Index Name: Phosphonous dichloride, ethyl-

**IUPAC name:** Ethylphosphonous dichloride

Synonyms: Ethylphosphorus dichloride

Ethylphosphinous dichloride

Ethylphosphinic dichloride

Ethyl dichlorophosphine

Dichloroethylphosphine

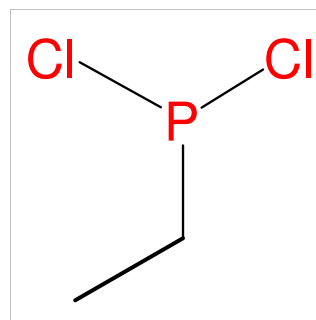

**Chemical name:** Isopropylphosphonic dichloride

Schedule: 2B04

CAS RN: 1498-46-0

HS code: 2931.39

Key: 1498-46-0

Molecular formula: C<sub>3</sub>H<sub>7</sub>Cl<sub>2</sub>OP

CAS Index Name: Phosphonic dichloride, (1-methylethyl)-

**IUPAC name:** Isopropylphosphonic dichloride

Synonyms: Phosphonic dichloride, isopropyl-  
Isopropylphosphonyl dichloride  
Isopropylphosphonic acid dichloride  
Dichloroisopropylphosphine oxide  
2-Propanephosphonyl chloride

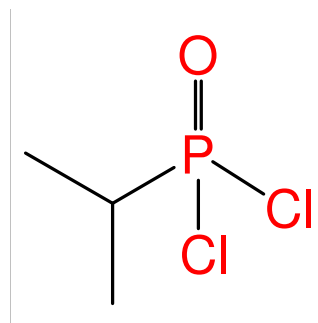

**Chemical name:** Isopropylphosphonothioic dichloride

Schedule: 2B04

CAS RN: 1498-60-8

HS code: 2931.39

Key: 1498-60-8

Molecular formula: C<sub>3</sub>H<sub>7</sub>Cl<sub>2</sub>PS

CAS Index Name: Phosphonothioic dichloride, (1-methylethyl)-

**IUPAC name:** Isopropylphosphonothioic dichloride

Synonyms: Isopropylphosphonothionyl dichloride  
Isopropylphosphonothiono dichloridic acid  
(1-Methylethyl)thioxophosphonic dichloride

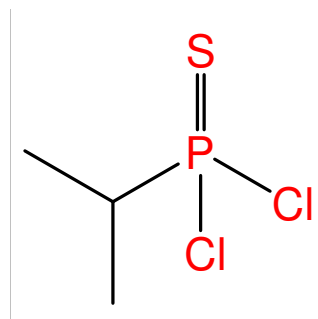

**Chemical name:** Isobutyl methyl methylphosphonate

Schedule: 2B04

CAS RN: 150799-85-2

HS code: 2931.39

Key: 150799-85-2

Molecular formula: C<sub>6</sub>H<sub>15</sub>O<sub>3</sub>P

CAS Index Name: Phosphonic acid, methyl-, (2-methylpropyl) methyl ester

**IUPAC name:** 2-Methylpropyl methyl methylphosphonate

Synonyms: O-(2-Methylpropyl) O- methyl methylphosphonate

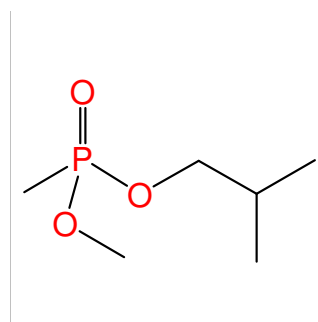

**Chemical name:** Propyl methylphosphonochloridate

Schedule: 2B04

CAS RN: 15110-09-5

HS code: 2931.39

Key: 15110-09-5

Molecular formula: C<sub>4</sub>H<sub>10</sub>ClP

CAS Index Name: Phosphonochloridic acid, methyl-, propyl ester

**IUPAC name:** Propyl methylphosphonochloridoate

Synonyms:

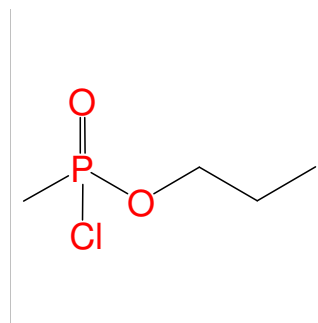

**Chemical name:** Methylphosphonofluoridic acid

Schedule: 2B04

CAS RN: 1511-67-7

HS code: 2931.39

Key: 1511-67-7

Molecular formula: CH<sub>4</sub>FO<sub>2</sub>P

CAS Index Name: Phosphonofluoridic acid, methyl-

**IUPAC name:** Methylphosphonofluoridic acid

Synonyms:

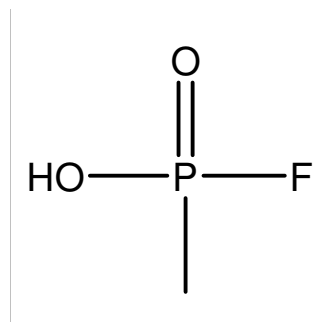

**Chemical name:** Reaction products of methylphosphonic acid and (aminoiminomethyl)urea (1:1) with formaldehyde

Schedule: 2B04

CAS RN: 151686-32-7

HS code:

Key: 151686-32-7

Molecular formula: Unspecified

CAS Index Name: Phosphonic acid, methyl-, compd. with (aminoiminomethyl)urea (1:1), reaction products with formaldehyde

**IUPAC name:**

Synonyms:

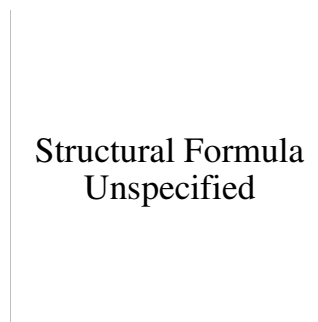

**Chemical name:** Diethyl isopropylphosphonate

Schedule: 2B04

CAS RN: 1538-69-8

HS code: 2931.39

Key: 1538-69-8

Molecular formula: C<sub>7</sub>H<sub>17</sub>O<sub>3</sub>P

CAS Index Name: Phosphonic acid, (1-methylethyl)-, diethyl ester

**IUPAC name:** Diethyl isopropylphosphonate

Synonyms: Phosphonic acid, isopropyl-, diethyl ester

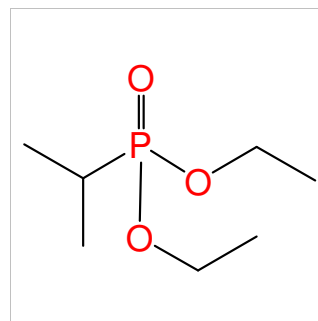



**Chemical name:** Propylphosphonous dichloride

Schedule: 2B04

CAS RN: 15573-31-6

HS code: 2931.39

Key: 15573-31-6

Molecular formula: C<sub>3</sub>H<sub>7</sub>Cl<sub>2</sub>P

CAS Index Name: Phosphonous dichloride, propyl-

**IUPAC name:** Propylphosphonous dichloride

Synonyms: Propylphosphorus dichloride  
Propylphosphinous dichloride  
Propylphosphinic dichloride  
Propyldichlorophosphine  
Phosphine, dichloropropyl-  
Dichloropropylphosphine

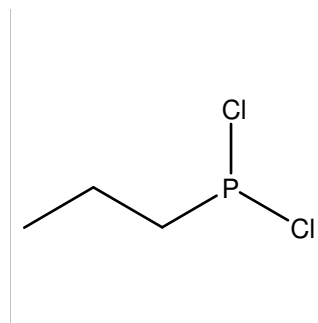

**Chemical name:** Diethyl methylphosphonite

Schedule: 2B04

CAS RN: 15715-41-0

HS code: 2931.39

Key: 15715-41-0

Molecular formula: C<sub>5</sub>H<sub>13</sub>O<sub>2</sub>P

CAS Index Name: Phosphonous acid, methyl-, diethyl ester

**IUPAC name:** Diethyl methylphosphonite

Synonyms: O,O-Diethyl methylphosphonite  
Methyldiethoxyphosphine  
Diethyl methanephosphonite  
Diethoxymethylphosphine

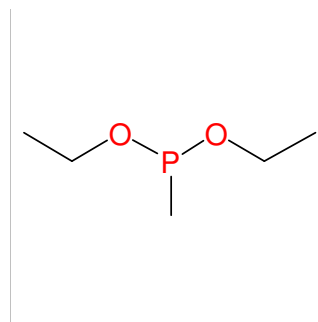

**Chemical name:** Dimethyl ethylphosphonite

Schedule: 2B04

CAS RN: 15715-42-1

HS code: 2931.39

Key: 15715-42-1

Molecular formula: C<sub>4</sub>H<sub>11</sub>O<sub>2</sub>P

CAS Index Name: Phosphonous acid, ethyl-, dimethyl ester

**IUPAC name:** Dimethyl ethylphosphonite

Synonyms: O,O-Dimethyl ethylphosphonite  
Ethyldimethoxyphosphine  
Dimethyl ethanephosphonite  
Dimethoxyethylphosphine

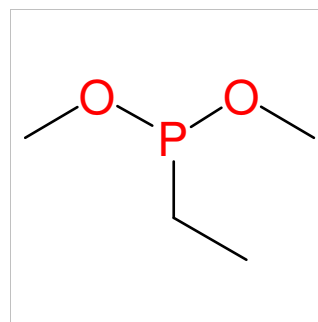

**Chemical name:** Isobutyl methylphosphonate

Schedule: 2B04

CAS RN: 1604-38-2

HS code: 2931.39

Key: 1604-38-2

Molecular formula: C<sub>5</sub>H<sub>13</sub>O<sub>3</sub>P

CAS Index Name: Phosphonic acid, methyl-, mono(2-methylpropyl) ester

**IUPAC name:** Isobutyl methylphosphonate

Synonyms: O-Isobutyl methylphosphonate

2-Methylpropyl methylphosphonate

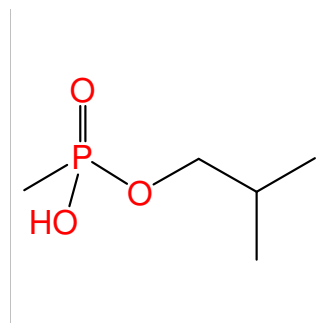

**Chemical name:** O-Cyclohexyl methylphosphonoyl tyrosine

Schedule: 2B04

CAS RN: 1631068-24-0

HS code: 2931.39

Key: 1631068-24-0

Molecular formula: C<sub>16</sub> H<sub>24</sub> N O<sub>5</sub> P

CAS Index Name: L-Tyrosine, O-[(cyclohexyloxy)methylphosphinyl]-

**IUPAC name:**

Synonyms: GF Tyrosine

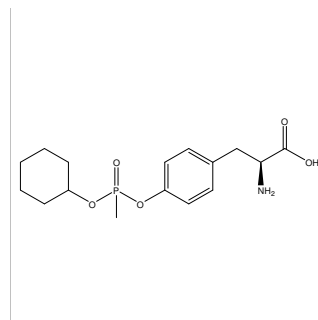

**Chemical name:** Ethyl methylphosphinate

Schedule: 2B04

CAS RN: 16391-07-4

HS code: 2931.39

Key: 16391-07-4

Molecular formula: C<sub>3</sub>H<sub>9</sub>O<sub>2</sub>P

CAS Index Name: Phosphinic acid, methyl-, ethyl ester

**IUPAC name:** Ethyl methylphosphinate

Synonyms: Ethyl methylphosphonite

Ethyl methanephosphonite

Ethyl methanephosphinate

Ethyl hydrogen methylphosphonite

Ethoxymethylphosphine oxide

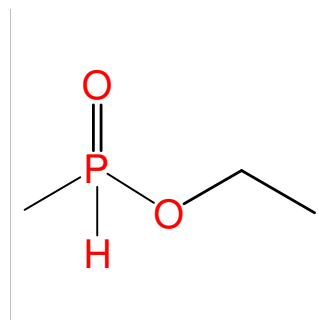

**Chemical name:** Diisobutyl methylphosphonothiolate

Schedule: 2B04

CAS RN: 168885-92-5

HS code: 2930.90

Key: 168885-92-5

Molecular formula: C<sub>9</sub>H<sub>21</sub>O<sub>2</sub>PS

CAS Index Name: Phosphonothioic acid, methyl-, O,O-bis(2-methylpropyl) ester

**IUPAC name:**

Synonyms:

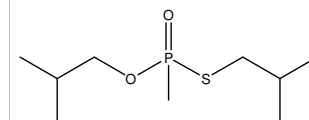

**Chemical name:** Dipinacolyl ethylphosphonate

Schedule: 2B04

CAS RN: 169739-48-4

HS code: 2931.39

Key: 169739-48-4

Molecular formula: C<sub>14</sub>H<sub>31</sub>O<sub>3</sub>P

CAS Index Name: Phosphonic acid, ethyl-, bis(1,2,2-trimethylpropyl) ester

**IUPAC name:** Bis(1,2,2-trimethylpropyl) ethylphosphonate

Synonyms: O,O-Dipinacolyl ethylphosphonate

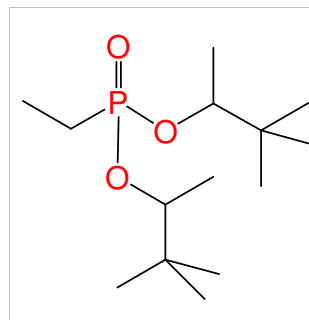

**Chemical name:** Isobutyl ethylphosphonate

Schedule: 2B04

CAS RN: 170082-56-1

HS code: 2931.39

Key: 170082-56-1

Molecular formula: C<sub>6</sub>H<sub>15</sub>O<sub>3</sub>P

CAS Index Name: Phosphonic acid, ethyl-, mono(2-methylpropyl) ester

**IUPAC name:**

Synonyms:

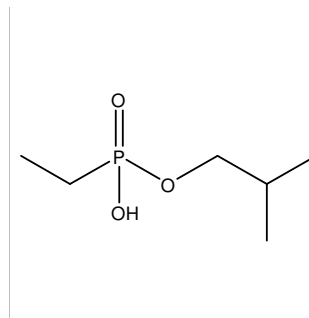

**Chemical name:** sec-Butyl methyl methylphosphonate

Schedule: 2B04

CAS RN: 170082-60-7

HS code: 2931.39

Key: 170082-60-7

Molecular formula: C<sub>6</sub>H<sub>15</sub>O<sub>3</sub>P

CAS Index Name: Phosphonic acid, methyl-, (1-methylpropyl) methyl ester

**IUPAC name:** sec-Butyl methyl methylphosphonate

Synonyms: O-(1-Methylpropyl) O- methyl methylphosphonate

Butan-2-yl methyl methylphosphonate

1-Methylpropyl methyl methylphosphonate

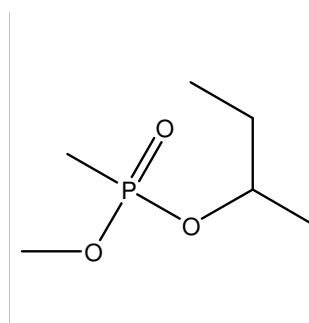

**Chemical name:** sec-Butyl isopropylphosphonochloridate

Schedule: 2B04

CAS RN: 170082-69-6

HS code: 2931.39

Key: 170082-69-6

Molecular formula: C<sub>7</sub>H<sub>16</sub>ClO<sub>2</sub>P

CAS Index Name: Phosphonochloridic acid, 1-methylethyl-, 1-methylpropyl ester

**IUPAC name:** sec-butyl isopropylphosphonochloridoate

Synonyms: Butan-2-yl isopropylphosphonochloridate

But-2-yl isopropylphosphonochloridate

1-Methylpropyl isopropylphosphonochloridate

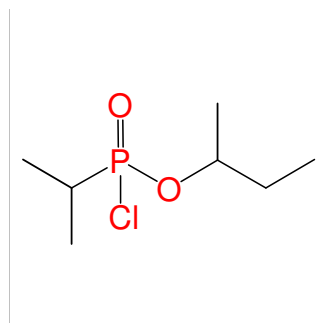

**Chemical name:** Isobutyl isopropylphosphonochloridate

Schedule: 2B04

CAS RN: 170082-70-9

HS code: 2931.39

Key: 170082-70-9

Molecular formula: C<sub>7</sub>H<sub>16</sub>ClO<sub>2</sub>P

CAS Index Name: Phosphonochloridic acid, 1-methylethyl-, 2-methylpropyl ester

**IUPAC name:** Isobutyl isopropylphosphonochloridoate

Synonyms: O-Isobutyl isopropylphosphonochloridate

2-Methylpropyl isopropylphosphonochloridate

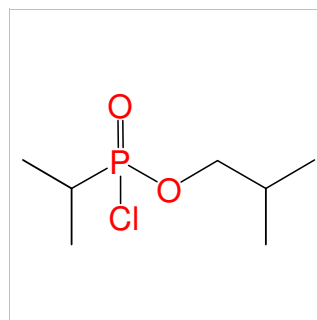

**Chemical name:** sec-Butyl propylphosphonochloridate

Schedule: 2B04

CAS RN: 170082-71-0

HS code: 2931.39

Key: 170082-71-0

Molecular formula: C<sub>7</sub>H<sub>16</sub>ClO<sub>2</sub>P

CAS Index Name: Phosphonochloridic acid, propyl-, 1-methylpropyl ester

**IUPAC name:** Sec-butyl propylphosphonochloridoate

Synonyms: Butan-2-yl propylphosphonochloridate

But-2-yl propylphosphonochloridate

1-Methylpropyl propylphosphonochloridate

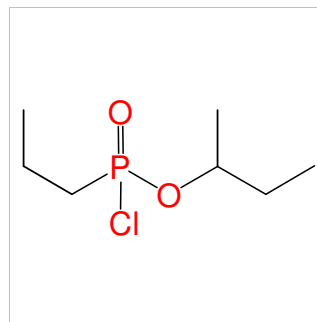

**Chemical name:** Isopropyl ethylphosphonate

Schedule: 2B04

CAS RN: 170135-50-9

HS code: 2931.39

Key: 170135-50-9

Molecular formula: C<sub>5</sub>H<sub>13</sub>O<sub>3</sub>P

CAS Index Name: Phosphonic acid, ethyl-, mono(1-methylethyl) ester

**IUPAC name:** Isopropyl ethylphosphonate

Synonyms: O-Isopropyl ethylphosphonate

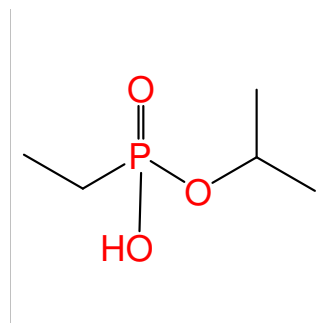

**Chemical name:** Heptyl methylphosphonate

Schedule: 2B04

CAS RN: 170275-32-8

HS code: 2931.39

Key: 170275-32-8

Molecular formula: C<sub>8</sub>H<sub>19</sub>O<sub>3</sub>P

CAS Index Name: Phosphonic acid, methyl-, monoheptyl ester

**IUPAC name:** Heptyl methylphosphonate

Synonyms:

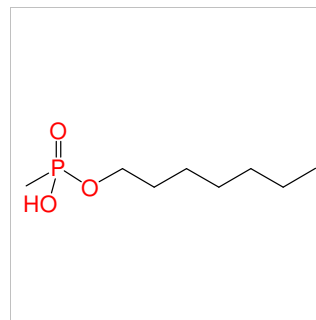

**Chemical name:** Bis(2-methoxyethyl) ethylphosphonate

Schedule: 2B04

CAS RN: 170275-34-0

HS code: 2931.39

Key: 170275-34-0

Molecular formula: C<sub>8</sub>H<sub>19</sub>O<sub>5</sub>P

CAS Index Name: Phosphonic acid, ethyl-, bis(2-methoxyethyl) ester

**IUPAC name:** Bis(2-methoxyethyl) ethylphosphonate

Synonyms:

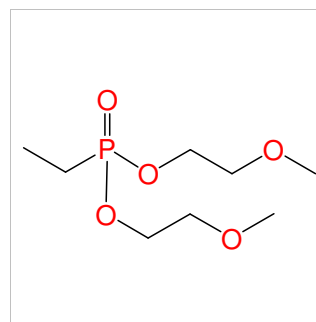

**Chemical name:** Pinacolyl isopropylphosphonochloridate

Schedule: 2B04

CAS RN: 170275-51-1

HS code: 2931.39

Key: 170275-51-1

Molecular formula: C<sub>9</sub>H<sub>20</sub>ClO<sub>2</sub>P

CAS Index Name: Phosphonochloridic acid, 1-methylethyl-, 1,2,2-trimethylpropyl ester

**IUPAC name:** 3,3-dimethylbutan-2-yl isopropylphosphonochloridate

Synonyms:

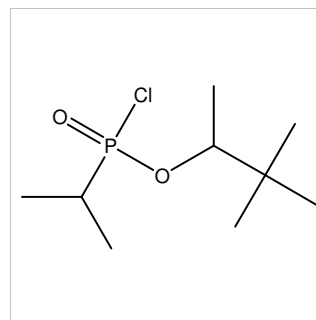

**Chemical name:** Cyclohexyl ethylphosphonate

Schedule: 2B04

CAS RN: 170424-87-0

HS code: 2931.39

Key: 170424-87-0

Molecular formula: C<sub>8</sub>H<sub>17</sub>O<sub>3</sub>P

CAS Index Name: Phosphonic acid, ethyl-, monocyclohexyl ester

**IUPAC name:** Cyclohexyl ethylphosphonate

Synonyms:

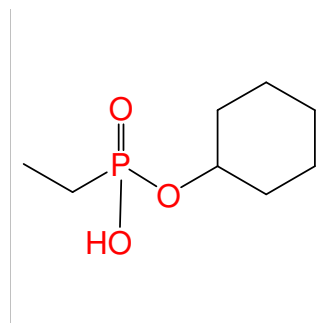

**Chemical name:** Mixture of (5-ethyl-2-methyl-2-oxido-1,3,2-dioxaphosphinan-5-yl)methyl methyl methylphosphonate (CAS RN 41203-81-0) and Bis[(5-Ethyl-2-methyl-2-oxido-1,3,2-dioxaphosphinan-5-yl)methyl] methylphosphonate (CAS RN 42595-45-9)

Schedule: 2B04

CAS RN: 170836-68-7

HS code: 3824.91

Key: 170836-68-7

Molecular formula: C<sub>15</sub>H<sub>31</sub>O<sub>9</sub>P<sub>3</sub>.C<sub>9</sub>H<sub>20</sub>O<sub>6</sub>P<sub>2</sub>

CAS Index Name: Phosphonic acid, P-methyl-, bis[(5-ethyl-2-methyl-2-oxido-1,3,2-dioxaphosphorinan-5-yl)methyl] ester, mixt. with (5-ethyl-2-methyl-2-oxido-1,3,2-dioxaphosphorinan-5-yl)methyl methyl P-methylphosphonate

**IUPAC name:**

Synonyms: Antiblaze 1045

Preflam

Pekoflam PES CN Liquid Concentrate

Mixture of CAS RN 41203-81-0 and CAS RN 42595-45-9

Flacavon

Antiblact

Antiblance U

Amgard 1045

Afflamit

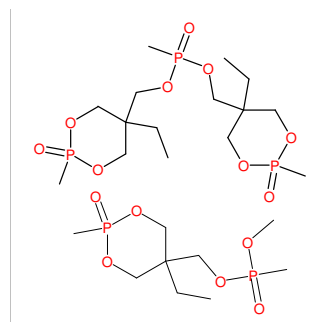

**Chemical name:** Ethyl S-sodium ethylphosphonothiolate

Schedule: 2B04

CAS RN: 17390-16-8

HS code: 2930.90

Key: 17390-16-8

Molecular formula: C<sub>4</sub>H<sub>10</sub>NaO<sub>2</sub>PS

CAS Index Name: Phosphonothioic acid, ethyl-, O-ethyl ester, sodium salt

**IUPAC name:** Sodium O-ethyl ethylphosphonothioate

Synonyms:

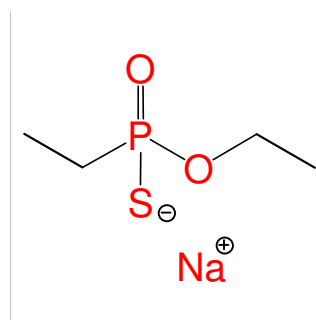

**Chemical name:** O-Cyclohexyl methylphosphonothiolate sodium salt

Schedule: 2B04

CAS RN: 173967-95-8

HS code: 2930.90

Key: 173967-95-8

Molecular formula: C<sub>7</sub>H<sub>14</sub>NaO<sub>2</sub>PS

CAS Index Name: Phosphonothioic acid, methyl-, O-cyclohexyl ester, sodium salt

**IUPAC name:**

Synonyms:

**Chemical name:** Methyltriphenoxyphosphonium iodide

Schedule: 2B04

CAS RN: 17579-99-6

HS code: 2931.39

Key: 17579-99-6

Molecular formula: C<sub>19</sub>H<sub>18</sub>O<sub>3</sub>P

CAS Index Name: Phosphorus(1+), methyltriphenoxy-, iodide

**IUPAC name:** Methyl(triphenoxy)phosphonium iodide

Synonyms: Triphenylphosphine methiodide

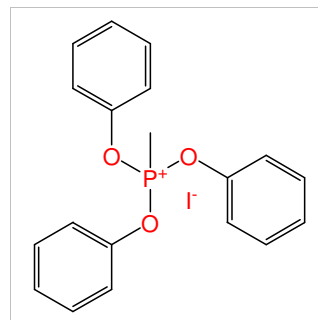

**Chemical name:** O-Ethyl methylphosphinothionate

Schedule: 2B04

CAS RN: 17698-78-1

HS code: 2930.90

Key: 17698-78-1

Molecular formula: C<sub>3</sub>H<sub>9</sub>O<sub>2</sub>PS

CAS Index Name: Phosphinothioic acid, methyl-, O-ethyl ester

**IUPAC name:** O-Ethyl methylphosphinothioate

Synonyms:

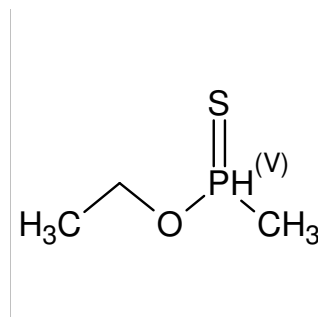

**Chemical name:** O-Propyl methylphosphonothionochloridate

Schedule: 2B04

CAS RN: 18005-37-3

HS code: 2931.39

Key: 18005-37-3

Molecular formula: C<sub>4</sub>H<sub>10</sub>ClO<sub>2</sub>PS

CAS Index Name: Phosphonochloridothioic acid, methyl-, O-propyl ester

**IUPAC name:** O-Propyl methylphosphonothionochloridoate

Synonyms: O-Propyl methanephosphonothionochloridate

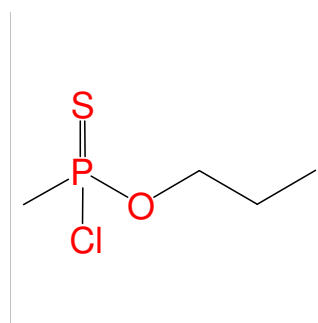

**Chemical name:** O-Ethyl methylphosphonothiolate

Schedule: 2B04

CAS RN: 18005-40-8

HS code: 2930.90

Key: 18005-40-8

Molecular formula: C<sub>3</sub>H<sub>9</sub>O<sub>2</sub>PS

CAS Index Name: Phosphonothioic acid, methyl-, O-ethyl ester

**IUPAC name:** O-Ethyl S-hydrogen methylphosphonothioate

Synonyms: O-Ethyl S-hydrogen methylphosphonothiolate

O-Ethyl methylthiophosphonate

EMPTA

EMPSH

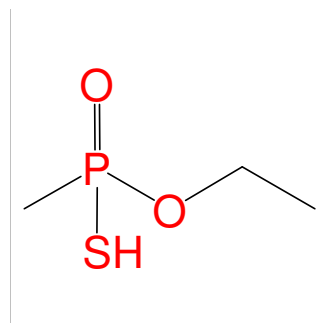

**Chemical name:** 2,4-dimethyl-1,3,2-dioxaphospholane-2-oxide

Schedule: 2B04

CAS RN: 1831-26-1

HS code: 2931.39

Key: 1831-26-1

Molecular formula: C<sub>4</sub>H<sub>9</sub>O<sub>3</sub>P

CAS Index Name: 1,3,2-Dioxaphospholane, 2,4-dimethyl-, 2-oxide

**IUPAC name:** 2,4-dimethyl-1,3,2-dioxaphospholane 2-oxide

Synonyms: Phosphonic acid, methyl-, cyclic propylene ester

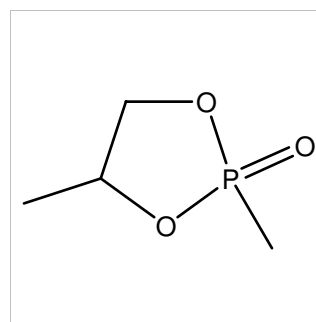

**Chemical name:** Ethyl methylphosphonate

Schedule: 2B04

CAS RN: 1832-53-7

HS code: 2931.39

Key: 1832-53-7

Molecular formula: C<sub>3</sub>H<sub>9</sub>O<sub>3</sub>P

CAS Index Name: Phosphonic acid, methyl-, monoethyl ester

**IUPAC name:** Ethyl methylphosphonate

Synonyms: Ethyl methanephosphonate

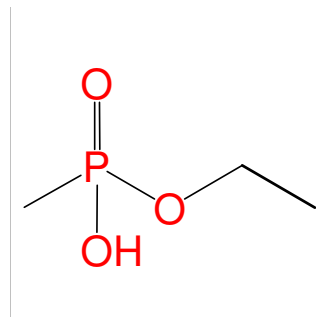

**Chemical name:** Isopropyl methylphosphonate

Schedule: 2B04

CAS RN: 1832-54-8

HS code: 2931.39

Key: 1832-54-8

Molecular formula: C<sub>4</sub>H<sub>11</sub>O<sub>3</sub>P

CAS Index Name: Phosphonic acid, methyl-, mono(1-methylethyl) ester

**IUPAC name:** Isopropyl methylphosphonate

Synonyms: Isopropyl methanephosphonate

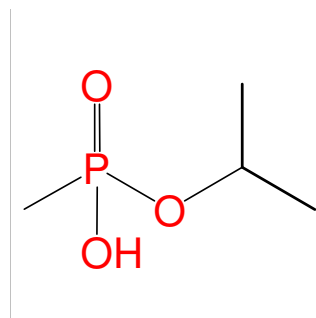



**Chemical name:** Butyl methylphosphonate

Schedule: 2B04

CAS RN: 1832-55-9

HS code: 2931.39

Key: 1832-55-9

Molecular formula: C<sub>5</sub>H<sub>13</sub>O<sub>3</sub>P

CAS Index Name: Phosphonic acid, methyl-, monobutyl ester

**IUPAC name:** Butyl methylphosphonate

Synonyms: O-Butyl methylphosphonate

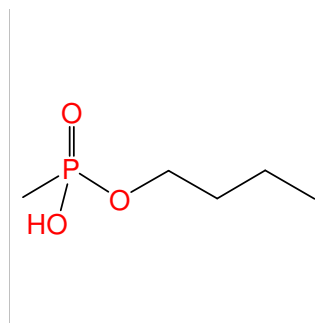

**Chemical name:** Octyl methylphosphonate

Schedule: 2B04

CAS RN: 1832-58-2

HS code: 2931.39

Key: 1832-58-2

Molecular formula: C<sub>9</sub>H<sub>21</sub>O<sub>3</sub>P

CAS Index Name: Phosphonic acid, methyl-, mono-octyl ester

**IUPAC name:** Octyl methylphosphonate

Synonyms: O-Octyl methylphosphonate

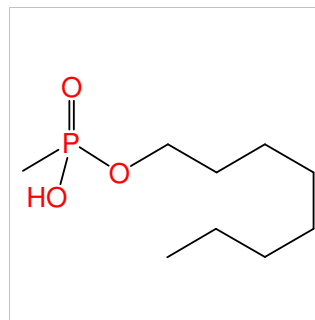

**Chemical name:** Nonyl methylphosphonate

Schedule: 2B04

CAS RN: 1832-60-6

HS code: 2931.39

Key: 1832-60-6

Molecular formula: C<sub>10</sub>H<sub>23</sub>O<sub>3</sub>P

CAS Index Name: Phosphonic acid, methyl-, monononyl ester

**IUPAC name:** Nonyl methylphosphonate

Synonyms:

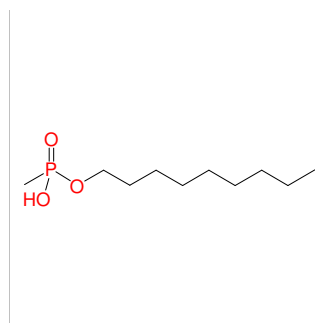

**Chemical name:** Dioctyl methylphosphonate

Schedule: 2B04

CAS RN: 1832-68-4

HS code: 2931.39

Key: 1832-68-4

Molecular formula: C<sub>17</sub>H<sub>37</sub>O<sub>3</sub>P

CAS Index Name: Phosphonic acid, methyl-, dioctyl ester

**IUPAC name:** Dioctyl methylphosphonate

Synonyms: O,O-Dioctyl methylphosphonate

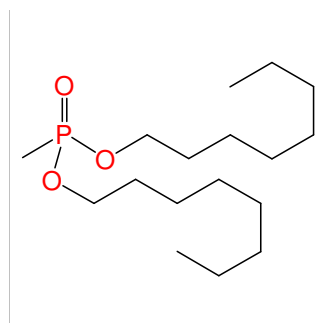

**Chemical name:** Isobutyl methylphosphonochloridate

Schedule: 2B04

CAS RN: 18359-05-2

HS code: 2931.39

Key: 18359-05-2

Molecular formula: C<sub>5</sub>H<sub>12</sub>ClO<sub>2</sub>P

CAS Index Name: Phosphonochloridic acid, methyl-, 2-methylpropyl ester

**IUPAC name:** Isobutyl methylphosphonochloridoate

Synonyms: Phosphonochloridic acid, methyl-, isobutyl ester

O-Isobutyl methylphosphonochloridate

Isobutyl chloromethylphosphinate

2-Methylpropyl methylphosphonochloridate

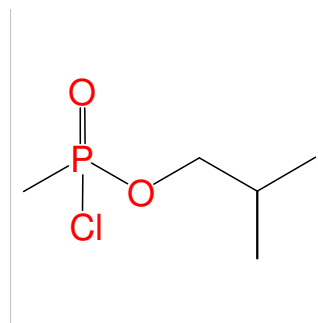

**Chemical name:** O,O-Dibutyl methylphosphonothionate

Schedule: 2B04

CAS RN: 18628-73-4

HS code: 2930.90

Key: 18628-73-4

Molecular formula: C<sub>9</sub>H<sub>21</sub>O<sub>2</sub>PS

CAS Index Name: Phosphonothioic acid, methyl-, O,O-dibutyl ester

**IUPAC name:** O,O-Dibutyl methylphosphonothioate

Synonyms: Dibutyl methylphosphonothionate

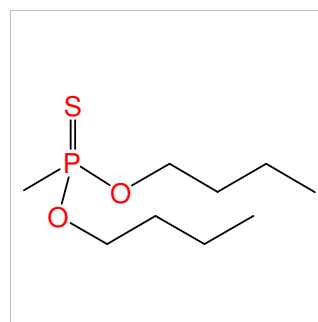

**Chemical name:** Ethyl methyl methylphosphonate

Schedule: 2B04

CAS RN: 18755-36-7

HS code: 2931.39

Key: 18755-36-7

Molecular formula: C<sub>4</sub>H<sub>11</sub>O<sub>3</sub>P

CAS Index Name: Phosphonic acid, methyl-, ethyl methyl ester

**IUPAC name:** Ethyl methyl methylphosphonate

Synonyms: O-Ethyl O-methyl methylphosphonate

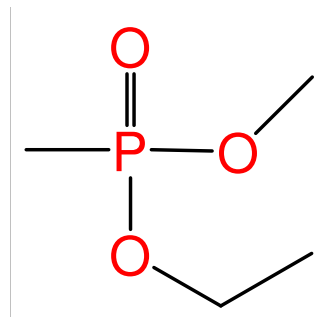

**Chemical name:** Dimethyl propylphosphonate

Schedule: 2B04

CAS RN: 18755-43-6

HS code: 2931.32

Key: 18755-43-6

Molecular formula: C<sub>5</sub>H<sub>13</sub>O<sub>3</sub>P

CAS Index Name: Phosphonic acid, propyl-, dimethyl ester

**IUPAC name:** Dimethyl propylphosphonate

Synonyms:

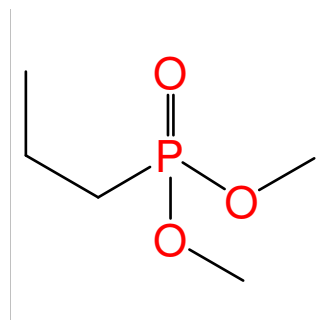

**Chemical name:** Methyl propyl propylphosphonate

Schedule: 2B04

CAS RN: 18755-44-7

HS code: 2931.39

Key: 18755-44-7

Molecular formula: C<sub>7</sub>H<sub>17</sub>O<sub>3</sub>P

CAS Index Name: Phosphonic acid, propyl-, methyl propyl ester

**IUPAC name:** Methyl propyl propylphosphonate

Synonyms: O-Methyl O-propyl propylphosphonate

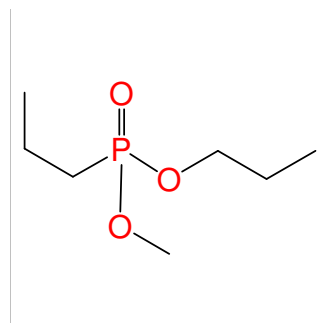

**Chemical name:** Diethyl propylphosphonate

Schedule: 2B04

CAS RN: 18812-51-6

HS code: 2931.39

Key: 18812-51-6

Molecular formula: C<sub>7</sub>H<sub>17</sub>O<sub>3</sub>P

CAS Index Name: Phosphonic acid, propyl-, diethyl ester

**IUPAC name:** Diethyl propylphosphonate

Synonyms: O,O-Diethyl propylphosphonate

Diethyl propanephosphonate

Diethoxypropylphosphine oxide

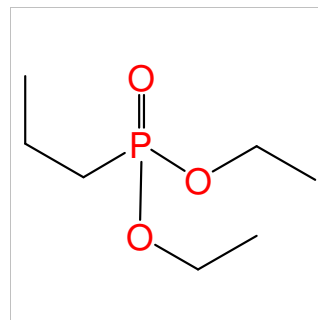

**Chemical name:** Diisopropyl propylphosphonate

Schedule: 2B04

CAS RN: 18812-55-0

HS code: 2931.39

Key: 18812-55-0

Molecular formula: C<sub>9</sub>H<sub>21</sub>O<sub>3</sub>P

CAS Index Name: Phosphonic acid, propyl-, bis(1-methylethyl) ester

**IUPAC name:** Diisopropyl propylphosphonate

Synonyms: O,O-Diisopropyl propylphosphonate

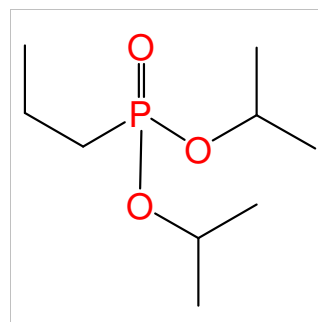

**Chemical name:** Dibenzyl methylphosphonate

Schedule: 2B04

CAS RN: 19236-58-9

HS code: 2931.39

Key: 19236-58-9

Molecular formula: C<sub>15</sub>H<sub>17</sub>O<sub>3</sub>P

CAS Index Name: Phosphonic acid, P-methyl-, bis(phenylmethyl) ester

**IUPAC name:** Dibenzyl methylphosphonate

Synonyms: Phosphonic acid, methyl-, dibenzyl ester

Phosphonic acid, methyl-, bis(phenylmethyl) ester

Methylphosphonic acid bis(phenylmethyl) ester

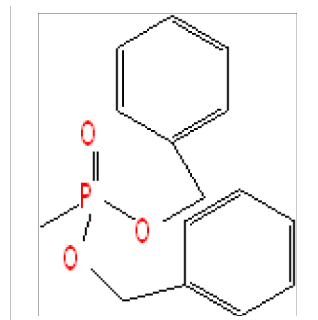

**Chemical name:** Dipinacolyl propylphosphonate

Schedule: 2B04

CAS RN: 192438-31-6

HS code: 2931.39

Key: 192438-31-6

Molecular formula: C<sub>15</sub>H<sub>33</sub>O<sub>3</sub>P

CAS Index Name: Phosphonic acid, propyl-, bis(1,2,2-trimethylpropyl) ester

**IUPAC name:** Bis(1,2,2-trimethylpropyl) propylphosphonate

Synonyms: O,O-Dipinacolyl propylphosphonate

Dipinacolyl propylphosphonate

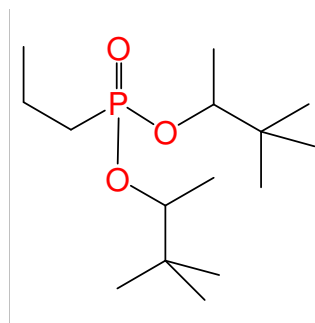

**Chemical name:** Dipropyl isopropylphosphonate

Schedule: 2B04

CAS RN: 192698-90-1

HS code: 2931.39

Key: 192698-90-1

Molecular formula: C<sub>9</sub>H<sub>21</sub>O<sub>3</sub>P

CAS Index Name: Phosphonic acid, 1-methylethyl-, dipropyl ester

**IUPAC name:** Dipropyl isopropylphosphonate

Synonyms: O,O-Dipropyl isopropylphosphonate

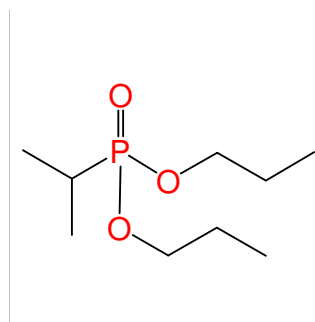

**Chemical name:** Cyclohexyl methylphosphonate

Schedule: 2B04

CAS RN: 1932-60-1

HS code: 2931.39

Key: 1932-60-1

Molecular formula: C<sub>7</sub>H<sub>15</sub>O<sub>3</sub>P

CAS Index Name: Phosphonic acid, methyl-, monocyclohexyl ester

**IUPAC name:** Cyclohexyl methylphosphonate

Synonyms: Cyclohexyl methylphosphonic acid

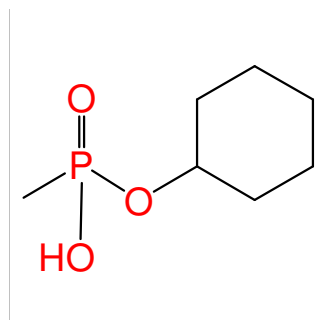

**Chemical name:** 1-Methylbutyl methylphosphonate

Schedule: 2B04

CAS RN: 198885-54-0

HS code: 2931.39

Key: 198885-54-0

Molecular formula: C<sub>6</sub>H<sub>15</sub>O<sub>3</sub>P

CAS Index Name: Phosphonic acid, methyl-, mono(1-methylbutyl) ester

**IUPAC name:** 1-Methylbutyl methylphosphonate

Synonyms: Pentan-2-yl methylphosphonate

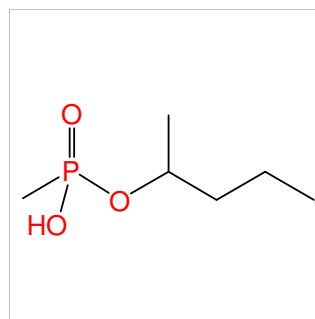

**Chemical name:** O-Isobutyl methylphosphonothiolate

Schedule: 2B04

CAS RN: 20626-99-7

HS code: 2930.90

Key: 20626-99-7

Molecular formula: C<sub>5</sub>H<sub>13</sub>O<sub>2</sub>PS

CAS Index Name: Phosphonothioic acid, methyl-, O-(2-methylpropyl) ester

**IUPAC name:** O-Isobutyl methylphosphonothioate

Synonyms: Phosphonothioic acid, methyl-, O-isobutyl ester

O-Isobutyl methylthiophosphonate

O-Isobutyl hydrogen methylphosphonothiolate

O-2-Methylpropyl methylphosphonothiolate

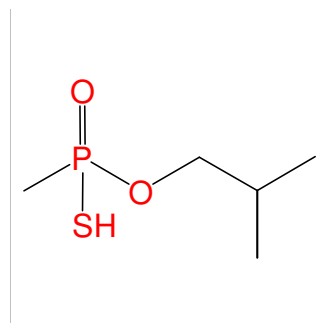

**Chemical name:** O-Isobutyl methylphosphonothionochloridate

Schedule: 2B04

CAS RN: 20627-03-6

HS code: 2930.90

Key: 20627-03-6

Molecular formula: C<sub>5</sub>H<sub>12</sub>ClO<sub>2</sub>PS

CAS Index Name: Phosphonochloridothioic acid, methyl-, O-(2-methylpropyl) ester

**IUPAC name:**

Synonyms:

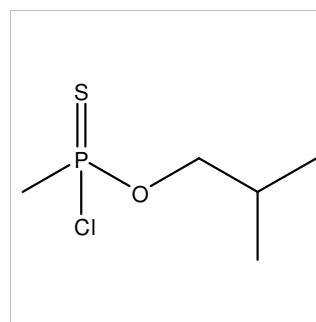

**Chemical name:** Isopropyl methyl propylphosphonate

Schedule: 2B04

CAS RN: 211923-89-6

HS code: 2931.39

Key: 211923-89-6

Molecular formula: C<sub>7</sub>H<sub>17</sub>O<sub>3</sub>P

CAS Index Name: Phosphonic acid, propyl-, 1-methylethyl methyl ester

**IUPAC name:** Isopropyl methyl propylphosphonate

Synonyms: O-Isopropyl O-methyl propylphosphonate

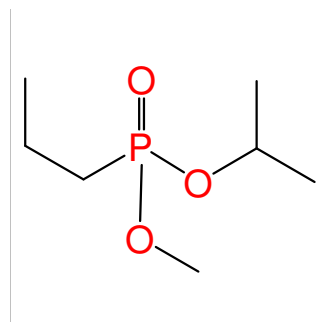

**Chemical name:** Propyl propylphosphonate

Schedule: 2B04

CAS RN: 21921-97-1

HS code: 2931.39

Key: 21921-97-1

Molecular formula: C<sub>6</sub>H<sub>15</sub>O<sub>3</sub>P

CAS Index Name: Phosphonic acid, propyl-, monopropyl ester

**IUPAC name:** Propyl propylphosphonate

Synonyms: O-Propyl propylphosphonate

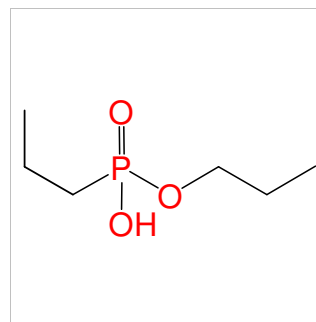

**Chemical name:** Ethyl S-sodium methylphosphonothiolate

Schedule: 2B04

CAS RN: 22307-81-9

HS code: 2930.90

Key: 22307-81-9

Molecular formula: C<sub>3</sub>H<sub>8</sub>NaO<sub>2</sub>PS

CAS Index Name: Phosphonothioic acid, methyl-, O-ethyl ester, sodium salt

**IUPAC name:** Sodium O-ethyl methylphosphonothioate

Synonyms: Sodium O-ethyl methylthiophosphonate

Sodium O-ethyl methylphosphonothiolate

Sodium ethyl methylphosphonothiolate

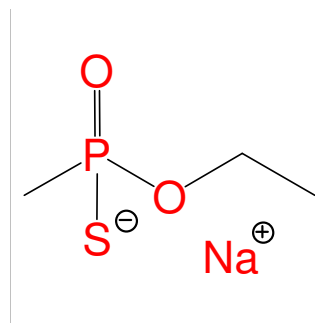

**Chemical name:** Dicyclopentyl methylphosphonate

Schedule: 2B04

CAS RN: 22583-27-3

HS code: 2931.39

Key: 22583-27-3

Molecular formula: C<sub>11</sub>H<sub>21</sub>O<sub>3</sub>P

CAS Index Name: Phosphonic acid, methyl-, dicyclopentyl ester

**IUPAC name:** Dicyclopentyl methylphosphonate

Synonyms: O,O-Dicyclopentyl methylphosphonate

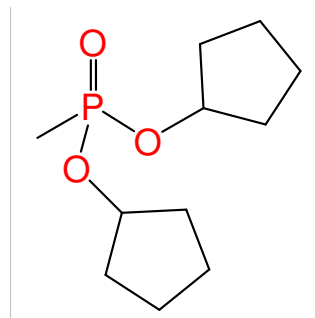

**Chemical name:** S-Ethyl methylphosphonothiolate

Schedule: 2B04

CAS RN: 23023-47-4

HS code: 2931.39

Key: 23023-47-4

Molecular formula: C<sub>3</sub>H<sub>9</sub>O<sub>2</sub>PS

CAS Index Name: Phosphonothioic acid, P-methyl-, S-ethyl ester

**IUPAC name:** S-Ethyl O-hydrogen methylphosphonothioate

Synonyms:

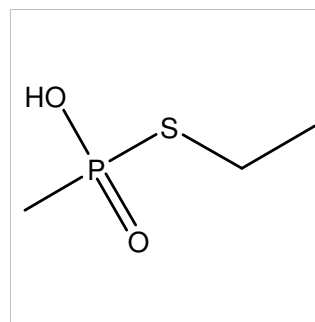

**Chemical name:** Butyl methylphosphonochloridate

Schedule: 2B04

CAS RN: 23164-47-8

HS code: 2931.39

Key: 23164-47-8

Molecular formula: C<sub>5</sub>H<sub>12</sub>ClO<sub>2</sub>P

CAS Index Name: Phosphonochloridic acid, methyl-, butyl ester

**IUPAC name:** Butyl methylphosphonochloridoate

Synonyms:

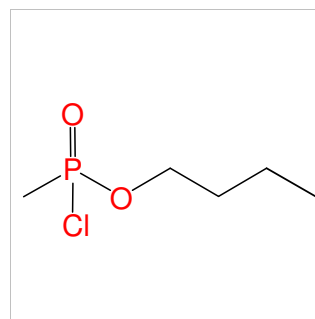

**Chemical name:** Dibutyl methylphosphonate

Schedule: 2B04

CAS RN: 2404-73-1

HS code: 2931.39

Key: 2404-73-1

Molecular formula: C<sub>9</sub>H<sub>21</sub>O<sub>3</sub>P

CAS Index Name: Phosphonic acid, methyl-, dibutyl ester

**IUPAC name:** Dibutyl methylphosphonate

Synonyms: Dibutyl methanephosphonate

Dibutoxymethylphosphine oxide

Di-n-butyl methanephosphonate

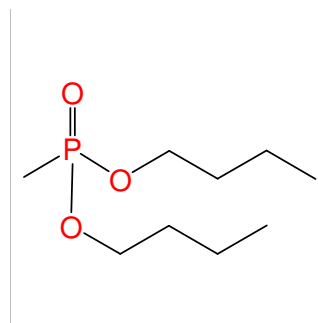

**Chemical name:** Ethyl N,N-diethyl-P-methylphosphonamidate

Schedule: 2B04

CAS RN: 2404-81-1

HS code: 2931.39

Key: 2404-81-1

Molecular formula: C<sub>7</sub>H<sub>18</sub>NO<sub>2</sub>P

CAS Index Name: Phosphonamidic acid, N,N-diethyl-P-methyl-, ethyl ester

**IUPAC name:**

Synonyms:

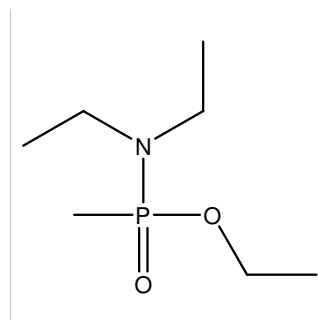

**Chemical name:** Pinacolyl propylphosphonate

Schedule: 2B04

CAS RN: 249934-12-1

HS code: 2931.39

Key: 249934-12-1

Molecular formula: C<sub>9</sub>H<sub>21</sub>O<sub>3</sub>P

CAS Index Name: Phosphonic acid, propyl-, mono(1,2,2-trimethylpropyl) ester

**IUPAC name:** 1,2,2-Trimethylpropyl propylphosphonate

Synonyms: O-Pinacolyl propylphosphonate

3,3-Dimethylbutan-2-yl propylphosphonate

3,3-Dimethylbut-2-yl propylphosphonate

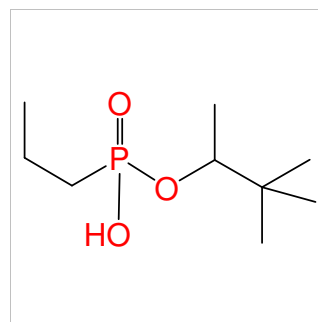

**Chemical name:** Methyl isopropylphosphonate

Schedule: 2B04

CAS RN: 249934-13-2

HS code: 2931.39

Key: 249934-13-2

Molecular formula: C<sub>4</sub>H<sub>11</sub>O<sub>3</sub>P

CAS Index Name: Phosphonic acid, (1-methylethyl)-, monomethyl ester

**IUPAC name:** Methyl isopropylphosphonate

Synonyms: O-Methyl isopropylphosphonate

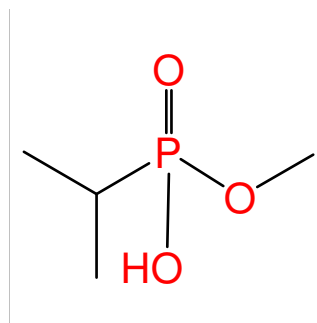

**Chemical name:** Isopropyl isopropylphosphonate

Schedule: 2B04

CAS RN: 249934-15-4

HS code: 2931.39

Key: 249934-15-4

Molecular formula: C<sub>6</sub>H<sub>15</sub>O<sub>3</sub>P

CAS Index Name: Phosphonic acid, (1-methylethyl)-, mono(1-methylethyl) ester

**IUPAC name:** Isopropyl isopropylphosphonate

Synonyms: O-Isopropyl isopropylphosphonate

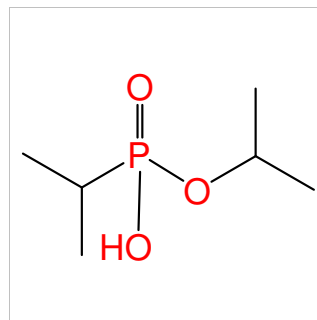

**Chemical name:** Pinacolyl isopropylphosphonate

Schedule: 2B04

CAS RN: 249934-16-5

HS code: 2931.39

Key: 249934-16-5

Molecular formula: C<sub>9</sub>H<sub>21</sub>O<sub>3</sub>P

CAS Index Name: Phosphonic acid, (1-methylethyl)-, mono(1,2,2-trimethylpropyl) ester

**IUPAC name:** 1,2,2-Trimethylpropyl isopropylphosphonate

Synonyms: O-Pinacolyl isopropylphosphonate

3,3-Dimethylbutan-2-yl isopropylphosphonate

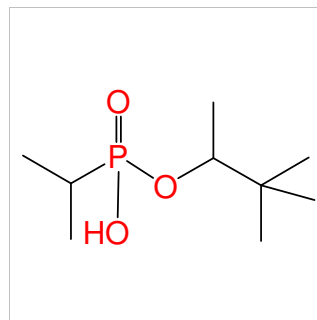

**Chemical name:** O-Ethyl S-ethyl methylphosphonothioate

Schedule: 2B04

CAS RN: 2511-10-6

HS code: 2930.90

Key: 2511-10-6

Molecular formula: C<sub>5</sub>H<sub>13</sub>O<sub>2</sub>PS

CAS Index Name: Phosphonothioic acid, methyl-, O,S-diethyl ester

**IUPAC name:** O,S-Diethyl methylphosphonothioate

Synonyms: O-Ethyl S-ethyl methylphosphonothioate

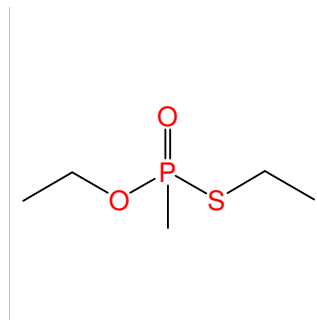



**Chemical name:** Methylphosphonic bis(dimethylamide)

Schedule: 2B04

CAS RN: 2511-17-3

HS code: 2931.39

Key: 2511-17-3

Molecular formula: C<sub>5</sub>H<sub>15</sub>N<sub>2</sub>OP

CAS Index Name: Phosphonic diamide, pentamethyl-

**IUPAC name:** N,N,N',N',P-pentamethylphosphonic diamide

Synonyms: Pentamethylphosphonic diamide

NSC 133862

Methylbis(dimethylamino)phosphine oxide

Methyl phosphonic acid bis(dimethylamide)

Diaphos

Bis(dimethylamino)methylphosphine oxide

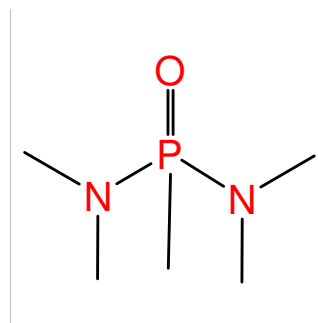

**Chemical name:** Isopropylphosphonous dichloride

Schedule: 2B04

CAS RN: 25235-15-8

HS code: 2931.39

Key: 25235-15-8

Molecular formula: C<sub>3</sub>H<sub>7</sub>Cl<sub>2</sub>P

CAS Index Name: Phosphonous dichloride, (1-methylethyl)-

**IUPAC name:** Isopropylphosphonous dichloride

Synonyms: Phosphonous dichloride, isopropyl-

Isopropylphosphorus dichloride

Isopropyldichlorophosphine

Dichloroisopropylphosphine

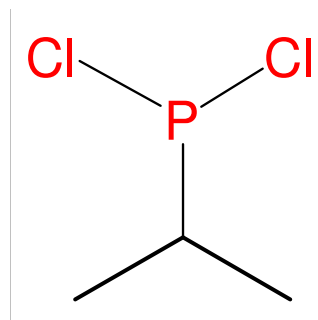

**Chemical name:** Propylphosphonothioic dichloride

Schedule: 2B04

CAS RN: 2524-01-8

HS code: 2931.39

Key: 2524-01-8

Molecular formula: C<sub>3</sub>H<sub>7</sub>Cl<sub>2</sub>PS

CAS Index Name: Phosphonothioic dichloride, propyl-

**IUPAC name:** Propylphosphonothioic dichloride

Synonyms: Propylthiophosphonic dichloride

Propylthiophosphonic acid dichloride

Dichloropropylphosphine sulfide

Propylthionophosphonyl dichloride

Propyl phosphonothioyl dichloride

Propanethiophosphonodichloridic acid

Propanephosphonothionodichloridic acid

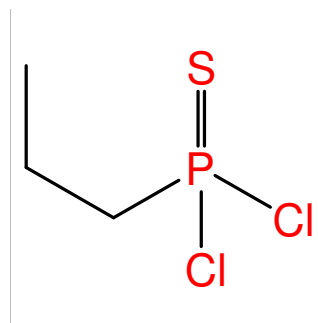

**Chemical name:** O-Methyl methylphosphonothionochloridate

Schedule: 2B04

CAS RN: 2524-15-4

HS code: 2931.39

Key: 2524-15-4

Molecular formula: C<sub>2</sub>H<sub>6</sub>ClO<sub>2</sub>PS

CAS Index Name: Phosphonochloridothioic acid, methyl-, O-methyl ester

**IUPAC name:** O-Methyl methylphosphonochloridothioate

Synonyms: O-Methyl methanephosphonothionochloridate

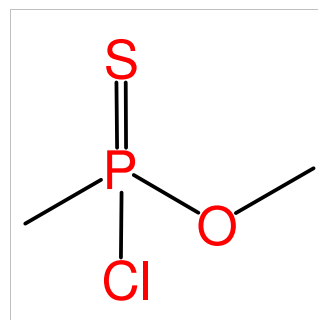

**Chemical name:** O-Ethyl methylphosphonothionochloridate

Schedule: 2B04

CAS RN: 2524-16-5

HS code: 2931.39

Key: 2524-16-5

Molecular formula: C<sub>3</sub>H<sub>8</sub>ClO<sub>2</sub>PS

CAS Index Name: Phosphonochloridothioic acid, methyl-, O-ethyl ester

**IUPAC name:** O-Ethyl methylphosphonochloridothioate

Synonyms: O-Ethyl methanephosphonothionochloridate

O-Ethyl (chloromethyl)thiophosphonate

Methylthionophosphonic acid O-ethyl ester chloride

Ethyl methanephosphonothionochloridate

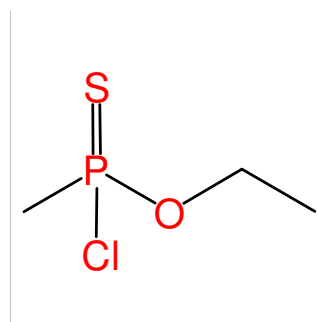

**Chemical name:** Diethyl ethylphosphonite

Schedule: 2B04

CAS RN: 2651-85-6

HS code: 2931.39

Key: 2651-85-6

Molecular formula: C<sub>6</sub>H<sub>15</sub>O<sub>2</sub>P

CAS Index Name: Phosphonous acid, ethyl-, diethyl ester

**IUPAC name:** Diethyl ethylphosphonite

Synonyms: Diethyl ethanephosphonite

Diethoxyethylphosphine

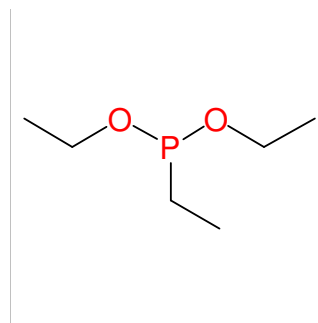

**Chemical name:** Propylphosphonothioic acid

Schedule: 2B04

CAS RN: 27797-35-9

HS code: 2930.90

Key: 27797-35-9

Molecular formula: C<sub>3</sub>H<sub>9</sub>O<sub>2</sub>PS

CAS Index Name: Phosphonothioic acid, propyl-

**IUPAC name:** Propylphosphonothioic O,O-acid

Synonyms:

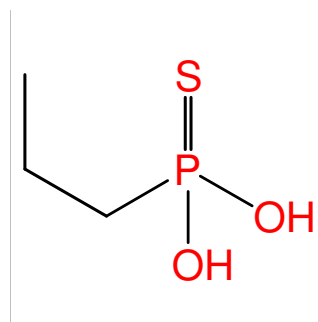

**Chemical name:** Bis(2-chloroethyl) methylphosphonate

Schedule: 2B04

CAS RN: 2799-58-8

HS code: 2931.39

Key: 2799-58-8

Molecular formula: C<sub>5</sub>H<sub>11</sub>Cl<sub>2</sub>O<sub>3</sub>P

CAS Index Name: Phosphonic acid, methyl-, bis(2-chloroethyl) ester

**IUPAC name:**

Synonyms: O,O-Di(2-chloroethyl) methylphosphonate

O,O-Bis(2-chloroethyl) methylphosphonate

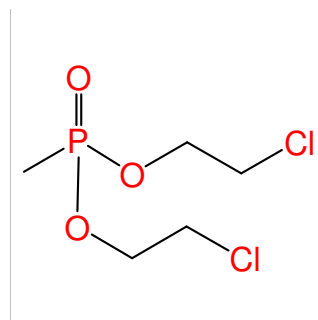

**Chemical name:** Diisopropyl dimethylpyrophosphate

Schedule: 2B04

CAS RN: 28616-51-5

HS code: 2931.39

Key: 28616-51-5

Molecular formula: C<sub>8</sub>H<sub>20</sub>O<sub>5</sub>P<sub>2</sub>

CAS Index Name: Diphosphonic acid, dimethyl-, bis(1-methylethyl) ester

**IUPAC name:** Diisopropyl dimethyldiphosphonate

Synonyms:

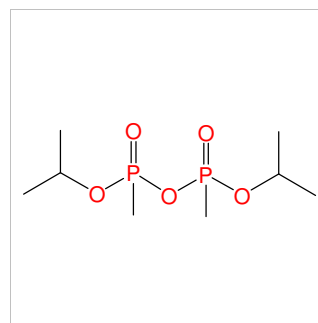

**Chemical name:** Isopropyl ethylphosphonochloridate

Schedule: 2B04

CAS RN: 28829-95-0

HS code: 2931.39

Key: 28829-95-0

Molecular formula: C<sub>5</sub>H<sub>12</sub>ClO<sub>2</sub>P

CAS Index Name: Phosphonochloridic acid, ethyl-, (1-methylethyl) ester

**IUPAC name:** Isopropyl ethylphosphonochloridoate

Synonyms: O-Isopropyl ethylphosphonochloridate

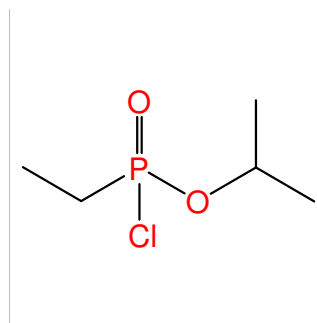

**Chemical name:** Ethyl propylphosphonochloridate

Schedule: 2B04

CAS RN: 28830-00-4

HS code: 2931.39

Key: 28830-00-4

Molecular formula: C<sub>5</sub>H<sub>12</sub>ClO<sub>2</sub>P

CAS Index Name: Phosphonochloridic acid, propyl-, ethyl ester

**IUPAC name:** Ethyl propylphosphonochloridoate

Synonyms:

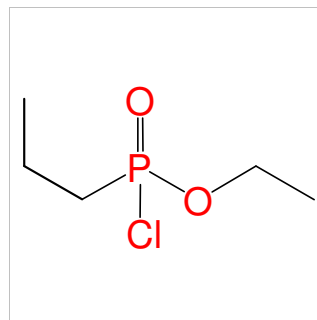

**Chemical name:** S-2-Dipropylaminoethyl methylphosphonothionofluoridate

Schedule: 2B04

CAS RN: 28841-40-9

HS code: 2930.90

Key: 28841-40-9

Molecular formula: C<sub>9</sub>H<sub>21</sub>FNOPS

CAS Index Name: Phosphonofluoridothioic acid, methyl-, S-[2-(dipropylamino)ethyl] ester

**IUPAC name:** S-2-Dipropylaminoethyl methylphosphonothionofluoridoate

Synonyms: S-2-Dipropylaminoethyl methylphosphonofluoridothioate

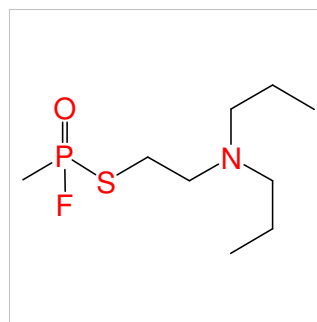

**Chemical name:** Phosphonic acid, methyl-, polyglycol ester (Exolit OP 560 TP)

Schedule: 2B04

CAS RN: 294675-51-7

HS code: 3824.99

Key: 294675-51-7

Molecular formula: Unspecified

CAS Index Name: Phosphonic acid, methyl-, polyglycol ester

**IUPAC name:**

Synonyms: Exolit OP 560 TP (Test Product)

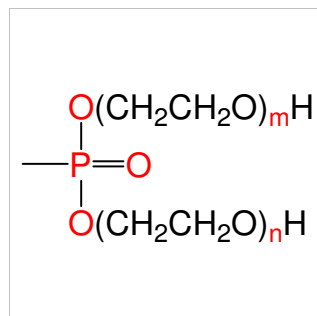

**Chemical name:** 3,9-Dimethyl-2,4,8,10-tetraoxa-3,9-diphosphaspiro[5.5]undecane 3,9-dioxide

Schedule: 2B04

CAS RN: 3001-98-7

HS code: 2931.39

Key: 3001-98-7

Molecular formula: C<sub>7</sub>H<sub>14</sub>O<sub>6</sub>P<sub>2</sub>

CAS Index Name: 2,4,8,10-Tetraoxa-3,9-diphosphaspiro[5.5]undecane, 3,9-dimethyl-, 3,9-dioxide

**IUPAC name:** 3,9-Dimethyl-2,4,8,10-tetraoxa-3,9-diphosphaspiro[5.5]undecane 3,9-dioxide

Synonyms: Phosphonic acid, methyl-, cyclic neopentetetrayl ester

Phosphonic acid, methyl-, cyclic diester with pentaerythritol

Pentaerythritol spirobis(methylphosphonate)

Pentaerythritol bis(methanephosphonate)

3,9-Dimethyl-3,9-dioxa-2,4,8,10-tetraoxa-3,9-diphosphaspiro-5,5 undecane

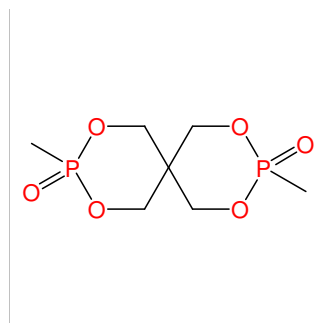

**Chemical name:** 1-Methyl-2-propynyl methylphosphonofluoridate

Schedule: 2B04

CAS RN: 30593-71-6

HS code: 2931.39

Key: 30593-71-6

Molecular formula: C<sub>5</sub>H<sub>8</sub>FO<sub>2</sub>P

CAS Index Name: Phosphonofluoridic acid, methyl-, 1-methyl-2-propynyl ester

**IUPAC name:** 1-Methylprop-2-yn-1-yl methylphosphonofluoridate

Synonyms: But-3-yn-2-yl methylphosphonofluoridate

1-Methylprop-2-ynyl methylphosphonofluoridate

1-Methylprop-2-ynyl methylphosphonofluoridate

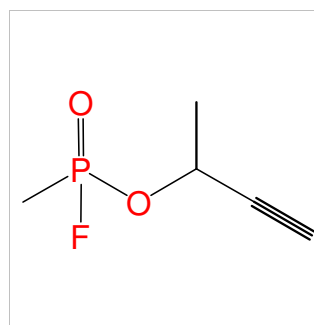

**Chemical name:** O-Ethyl O-(2,4,5-trichlorophenyl) ethylphosphonothionate

Schedule: 2B04

CAS RN: 327-98-0

HS code: 2930.90

Key: 327-98-0

Molecular formula: C<sub>10</sub>H<sub>12</sub>Cl<sub>3</sub>O<sub>2</sub>PS

CAS Index Name: Phosphonothioic acid, ethyl-, O-ethyl O-(2,4,5-trichlorophenyl) ester

IUPAC name: O-Ethyl O-(2,4,5-trichlorophenyl) ethylphosphonothioate

Synonyms: Trichloronate

Trichloronat

S 4400

Richloronate

Phytosol

Fitosol

ENT-25712

Chemagro 37289

Bayer S 4400

Bayer 5081

Bayer 37289

BAY 37289

Agritox

5082A

(+)-Trichloronate

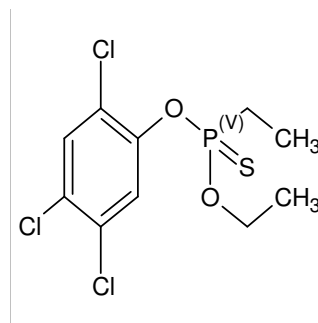

**Chemical name:** Isopropyl methyl isopropylphosphonate

Schedule: 2B04

CAS RN: 331954-04-2

HS code: 2931.39

Key: 331954-04-2

Molecular formula: C<sub>7</sub>H<sub>17</sub>O<sub>3</sub>P

CAS Index Name: Phosphonic acid, (1-methylethyl)-, 1-methylethyl methyl ester

IUPAC name: Isopropyl methyl isopropylphosphonate

Synonyms: O-Isopropyl O-methyl isopropylphosphonate

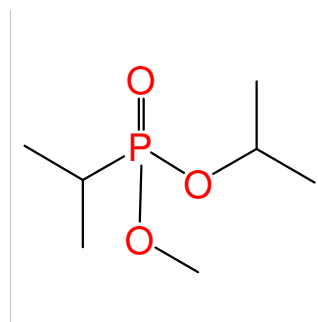

**Chemical name:** Ammonium hydrogen methylphosphonate

Schedule: 2B04

CAS RN: 34255-87-3

HS code: 2931.39

Key: 34255-87-3

Molecular formula: CH<sub>5</sub>O<sub>3</sub>P.H<sub>3</sub>N

CAS Index Name: Phosphonic acid, methyl-, monoammonium salt

**IUPAC name:** Ammonium hydrogen methylphosphonate

Synonyms: Monoammonium methanephosphonate

Ammonium methyl phosphonate

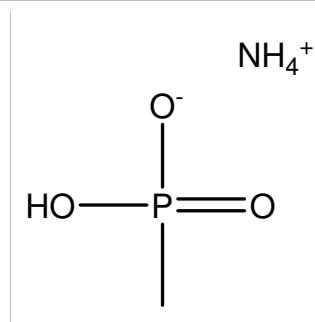

**Chemical name:** Aluminium methyl methylphosphonate

Schedule: 2B04

CAS RN: 35851-62-8

HS code: 2931.39

Key: 35851-62-8

Molecular formula: [C<sub>2</sub>H<sub>6</sub>O<sub>3</sub>P]<sub>3</sub>.Al

CAS Index Name: Phosphonic acid, methyl-, monomethyl ester, aluminium salt

**IUPAC name:** Aluminium methyl methylphosphonate

Synonyms:

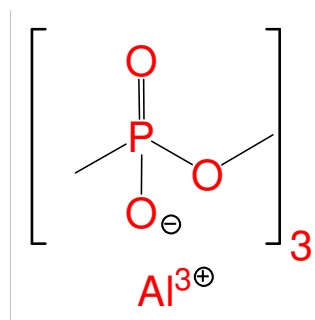

**Chemical name:** Bis(polyoxyethylene) methylphosphonate

Schedule: 2B04

CAS RN: 363626-50-0

HS code: 2930.90

Key: 363626-50-0

Molecular formula: (C<sub>2</sub>H<sub>4</sub>O)<sub>n</sub> (C<sub>2</sub>H<sub>4</sub>O)<sub>n</sub> CH<sub>5</sub>O<sub>3</sub>P

CAS Index Name: Poly(oxy-1,2-ethanediyl), α,α'-(methylphosphinylidene)bis[ω-hydroxy-

**IUPAC name:**

Synonyms: Polyethylene glycol methylphosphonate (2:1)

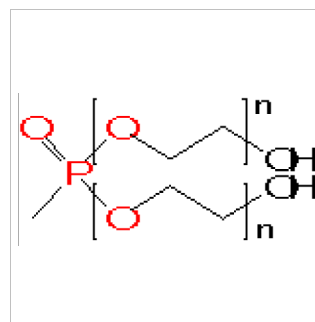

**Chemical name:** Diisopropyl isopropylphosphonate

Schedule: 2B04

CAS RN: 3759-39-5

HS code: 2931.39

Key: 3759-39-5

Molecular formula: C<sub>9</sub>H<sub>21</sub>O<sub>3</sub>P

CAS Index Name: Phosphonic acid, (1-methylethyl)-, bis(1-methylethyl) ester

**IUPAC name:** Diisopropyl isopropylphosphonate

Synonyms: O,O-Diisopropyl isopropylphosphonate

Isopropylphosphonic acid diisopropyl ester

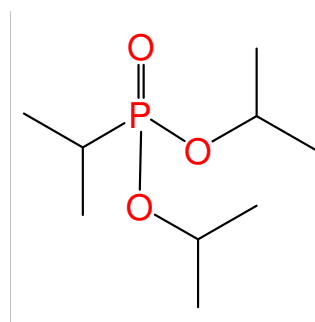

**Chemical name:** (5-Ethyl-2-methyl-2-oxido-1,3,2-dioxaphosphinan-5-yl)methyl methyl methylphosphonate

Schedule: 2B04

CAS RN: 41203-81-0

HS code: 2931.36

Key: 41203-81-0

Molecular formula: C<sub>9</sub>H<sub>20</sub>O<sub>6</sub>P<sub>2</sub>

CAS Index Name: Phosphonic acid, methyl-, (5-ethyl-2-methyl-2-oxido-1,3,2-dioxaphosphorinan-5-yl) methyl methyl ester

**IUPAC name:** (5-Ethyl-2-methyl-2-oxido-1,3,2-dioxaphosphinan-5-yl)methyl methyl methylphosphonate

Synonyms: Phosphonic acid, methyl-, (5-ethyl-2-methyl-1,3,2-dioxaphosphorinan-5-yl) methyl methyl P-oxide

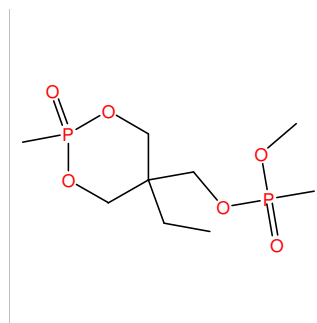

**Chemical name:** Methylphosphinic acid

Schedule: 2B04

CAS RN: 4206-94-4

HS code: 2931.39

Key: 4206-94-4

Molecular formula: CH<sub>5</sub>O<sub>2</sub>P

CAS Index Name: Phosphinic acid, methyl-

**IUPAC name:** Methylphosphinic acid

Synonyms:

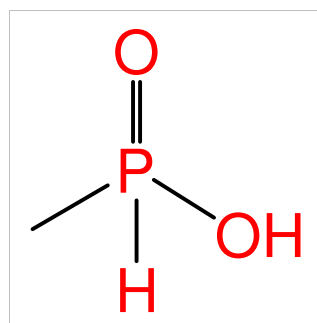

**Chemical name:** O-Cyclohexyl methylphosphonothionofluoridate

Schedule: 2B04

CAS RN: 4241-34-3

HS code: 2930.90

Key: 4241-34-3

Molecular formula: C<sub>7</sub>H<sub>14</sub>FOPS

CAS Index Name: Phosphonofluoridothioic acid, methyl-, O-cyclohexyl ester

**IUPAC name:** O-Cyclohexyl methylphosphonofluoridothioate

Synonyms: O-Cyclohexyl methylphosphonothionofluoridoate

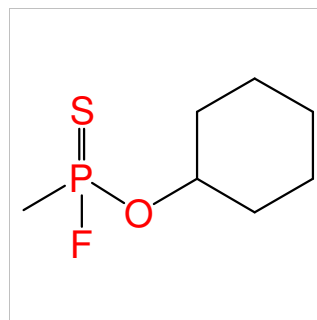



**Chemical name:** Bis[(5-Ethyl-2-methyl-2-oxido-1,3,2-dioxaphosphinan-5-yl)methyl] methylphosphonate

Schedule: 2B04

CAS RN: 42595-45-9

HS code: 2931.37

Key: 42595-45-9

Molecular formula: C<sub>15</sub>H<sub>31</sub>O<sub>9</sub>P<sub>3</sub>

CAS Index Name: Phosphonic acid, methyl-, bis[(5-ethyl-2-methyl-2-oxido-1,3,2-dioxaphosphorinan-5-yl)methyl] ester

**IUPAC name:** Bis[(5-ethyl-2-methyl-2-oxido-1,3,2-dioxaphosphinan-5-yl)methyl] methylphosphonate

Synonyms: Phosphonic acid, methyl-, bis[(5-ethyl-2-methyl-1,3,2-dioxaphosphorinan-5-yl)methyl] ester, P,P'-dioxide

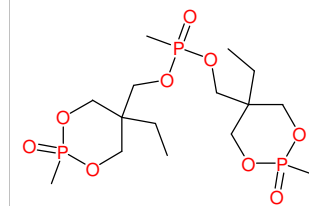

**Chemical name:** Ethylphosphinic acid

Schedule: 2B04

CAS RN: 4363-06-8

HS code: 2931.39

Key: 4363-06-8

Molecular formula: C<sub>2</sub>H<sub>7</sub>O<sub>2</sub>P

CAS Index Name: Phosphinic acid, ethyl-

**IUPAC name:**

Synonyms: Ethylhydroxyphosphine oxide

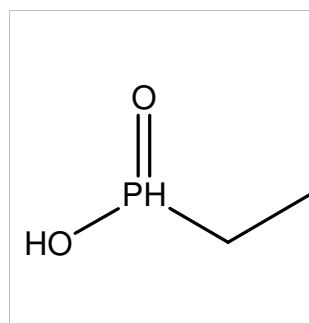

**Chemical name:** Propyl methylphosphonate

Schedule: 2B04

CAS RN: 4546-11-6

HS code: 2931.39

Key: 4546-11-6

Molecular formula: C<sub>4</sub>H<sub>11</sub>O<sub>3</sub>P

CAS Index Name: Phosphonic acid, methyl-, monopropyl ester

**IUPAC name:** Propyl methylphosphonate

Synonyms: Monopropyl methylphosphonate

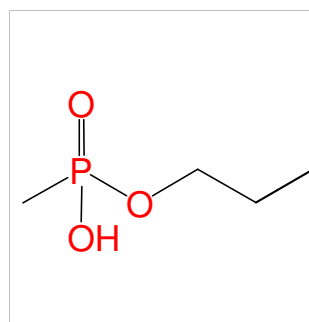

**Chemical name:** Ethyl isopropylphosphonate

Schedule: 2B04

CAS RN: 4546-12-7

HS code: 2931.39

Key: 4546-12-7

Molecular formula: C<sub>5</sub>H<sub>13</sub>O<sub>3</sub>P

CAS Index Name: Phosphonic acid, (1-methylethyl)-, monoethyl ester

**IUPAC name:** Ethyl isopropylphosphonate

Synonyms: O-Ethyl isopropylphosphonate

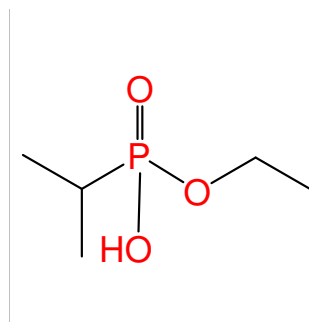

**Chemical name:** Bis(1-methylbutyl) methylphosphonate

Schedule: 2B04

CAS RN: 460091-25-2

HS code: 2931.39

Key: 460091-25-2

Molecular formula: C<sub>11</sub>H<sub>25</sub>O<sub>3</sub>P

CAS Index Name: Phosphonic acid, methyl-, bis(1-methylbutyl) ester

**IUPAC name:** Bis(1-methylbutyl) methylphosphonate

Synonyms: Bis(pentan-2-yl) methylphosphonate

Bis(pent-2-yl) methylphosphonate

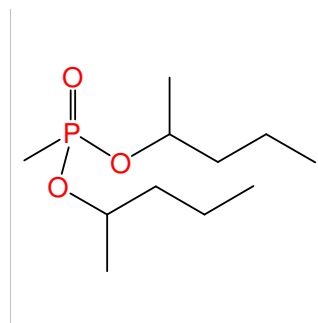

**Chemical name:** Dibutyl propylphosphonate

Schedule: 2B04

CAS RN: 4628-12-0

HS code: 2931.39

Key: 4628-12-0

Molecular formula: C<sub>11</sub>H<sub>25</sub>O<sub>3</sub>P

CAS Index Name: Phosphonic acid, propyl-, dibutyl ester

**IUPAC name:** Dibutyl propylphosphonate

Synonyms: Di-n-butyl-1-propylphosphonate

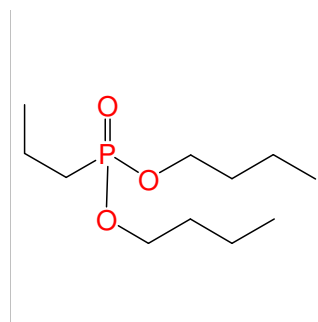

**Chemical name:** Propylphosphonic acid

Schedule: 2B04

CAS RN: 4672-38-2

HS code: 2931.39

Key: 4672-38-2

Molecular formula: C<sub>3</sub>H<sub>9</sub>O<sub>3</sub>P

CAS Index Name: Phosphonic acid, propyl-

**IUPAC name:** Propylphosphonic acid

Synonyms: Propanephosphonic acid

PPA

NIA 10656

n-Propylphosphonic acid

Dihydrogen propylphosphonate

1-Propylphosphonic acid

1-Propanephosphonic acid

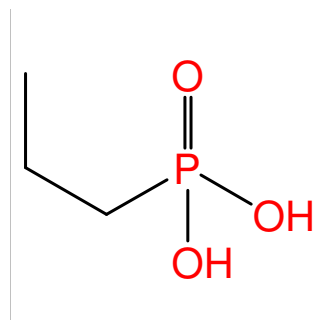

**Chemical name:** 2-Methoxyethyl methylphosphonofluoridate

Schedule: 2B04

CAS RN: 468711-92-4

HS code: 2931.39

Key: 468711-92-4

Molecular formula: C<sub>4</sub>H<sub>10</sub>FO<sub>3</sub>P

CAS Index Name: Phosphonofluoridic acid, P-methyl-, 2-methoxyethyl ester

**IUPAC name:** 2-Methoxyethyl methylphosphonofluoridate

Synonyms:

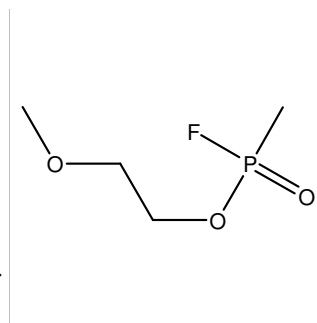

**Chemical name:** 2-Ethoxyethyl methylphosphonofluoridate

Schedule: 2B04

CAS RN: 468711-93-5

HS code: 2931.39

Key: 468711-93-5

Molecular formula: C<sub>5</sub>H<sub>12</sub>FO<sub>3</sub>P

CAS Index Name: Phosphonofluoridic acid, P-methyl-, 2-ethoxyethyl ester

**IUPAC name:** 2-Ethoxyethyl methylphosphonofluoridate

Synonyms:

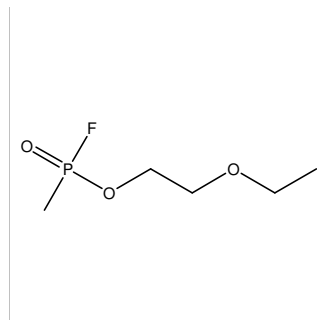

**Chemical name:** Propylphosphonic dichloride

Schedule: 2B04

CAS RN: 4708-04-7

HS code: 2931.39

Key: 4708-04-7

Molecular formula: C<sub>3</sub>H<sub>7</sub>Cl<sub>2</sub>OP

CAS Index Name: Phosphonic dichloride, propyl-

**IUPAC name:** Propylphosphonic dichloride

Synonyms: Propylphosphonyl dichloride

Propanephosphonyl chloride

Dichloropropylphosphine oxide

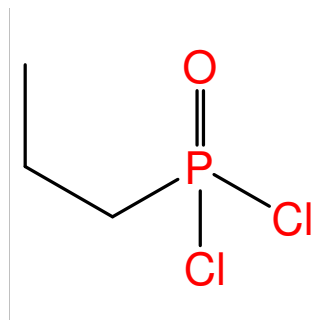

**Chemical name:** Isopropylphosphonic Acid

Schedule: 2B04

CAS RN: 4721-37-3

HS code: 2931.39

Key: 4721-37-3

Molecular formula: C<sub>3</sub>H<sub>9</sub>O<sub>3</sub>P

CAS Index Name: Phosphonic acid, P-(1-methylethyl)-

**IUPAC name:**

Synonyms:

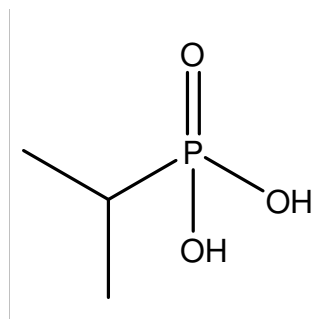

**Chemical name:** P-methylphosphonic diamide

Schedule: 2B04

CAS RN: 4759-30-2

HS code: 2931.39

Key: 4759-30-2

Molecular formula: CH<sub>7</sub>N<sub>2</sub>OP

CAS Index Name: Phosphonic diamide, P-methyl-

**IUPAC name:** P-methylphosphonic diamide

Synonyms: Methylphosphonic acid diamide

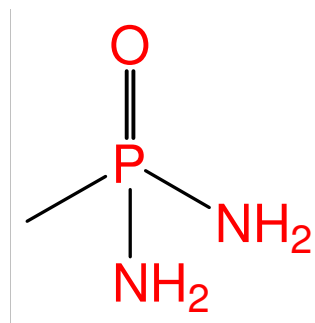

**Chemical name:** Potassium ethyl methylphosphonothionate

Schedule: 2B04

CAS RN: 50375-90-1

HS code: 2930.90

Key: 50375-90-1

Molecular formula: C<sub>3</sub>H<sub>8</sub>O<sub>2</sub>PS.K

CAS Index Name: Phosphonothioic acid, methyl-, O-ethyl ester, potassium salt

**IUPAC name:** Potassium ethyl methylphosphonothioate

Synonyms: Potassium O-ethyl methylthiophosphonate

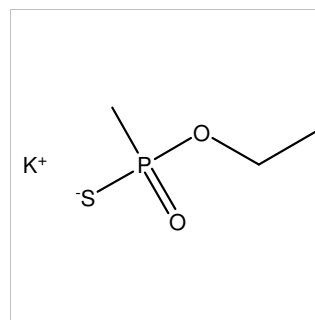

**Chemical name:** Oxypropylated ether of methylphosphonyl pentaerythritol

Schedule: 2B04

CAS RN: 50886-86-7

HS code:

Key: 50886-86-7

Molecular formula: C<sub>6+6n</sub> H<sub>13+12n</sub> O<sub>5+2n</sub> P

CAS Index Name: Phosphonic acid, methyl-, polymer with 2,2-bis(hydroxymethyl)-1,3-propanediol and methylloxirane

**IUPAC name:**

Synonyms: Phospholyol II

Oxirane, methyl-, polymer with 2,2-bis(hydroxymethyl)-1,3-propanediol and methylphosphonic acid

Methylphosphonic acid-pentaerythritol-propylene oxide polymer

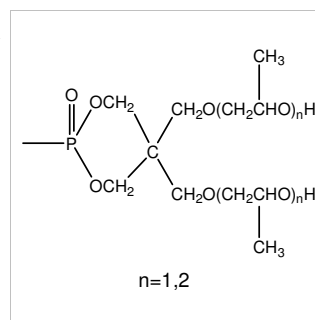

**Chemical name:** Propyl S-sodium methylphosphonothiolate

Schedule: 2B04

CAS RN: 51825-84-4

HS code: 2930.90

Key: 51825-84-4

Molecular formula: C<sub>4</sub>H<sub>10</sub>NaO<sub>2</sub>PS

CAS Index Name: Phosphonothioic acid, methyl-, O-propyl ester, sodium salt

**IUPAC name:** Sodium O-propyl methylphosphonothioate

Synonyms:

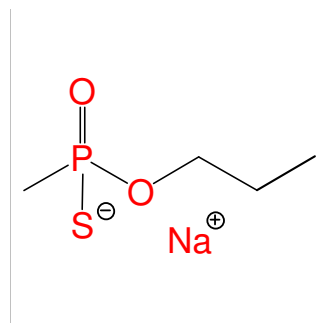

**Chemical name:** Butyl S-sodium methylphosphonothiolate

Schedule: 2B04

CAS RN: 51825-85-5

HS code: 2930.90

Key: 51825-85-5

Molecular formula: C<sub>5</sub>H<sub>12</sub>NaO<sub>2</sub>PS

CAS Index Name: Phosphonothioic acid, methyl-, O-butyl ester, sodium salt

**IUPAC name:** Sodium O-butyl methylphosphonothioate

Synonyms: O-Butyl S-sodium methylphosphonothiolate

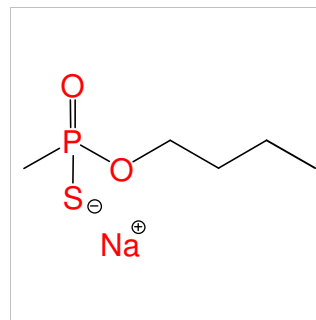

**Chemical name:** Ethyl methylphosphonochloridate

Schedule: 2B04

CAS RN: 5284-09-3

HS code: 2931.39

Key: 5284-09-3

Molecular formula: C<sub>3</sub>H<sub>8</sub>ClO<sub>2</sub>P

CAS Index Name: Phosphonochloridic acid, methyl-, ethyl ester

**IUPAC name:** Ethyl methylphosphonochloridoate

Synonyms: O-Ethyl chloromethylphosphonate

Ethyl methanephosphonochloridate

Chloroethoxymethylphosphine oxide

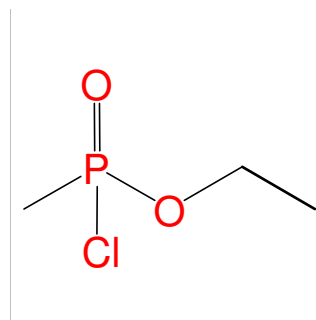

**Chemical name:** Isopropyl propylphosphonate

Schedule: 2B04

CAS RN: 53621-99-1

HS code: 2931.39

Key: 53621-99-1

Molecular formula: C<sub>6</sub>H<sub>15</sub>O<sub>3</sub>P

CAS Index Name: Phosphonic acid, propyl-, mono(1-methylethyl) ester

**IUPAC name:** Isopropyl propylphosphonate

Synonyms: O-Isopropyl propylphosphonate

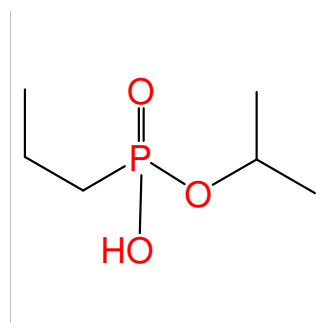

**Chemical name:** Dimethyl isopropylphosphonate

Schedule: 2B04

CAS RN: 54552-77-1

HS code: 2931.39

Key: 54552-77-1

Molecular formula: C<sub>5</sub>H<sub>13</sub>O<sub>3</sub>P

CAS Index Name: Phosphonic acid, (1-methylethyl)-, dimethyl ester

**IUPAC name:** Dimethyl isopropylphosphonate

Synonyms:

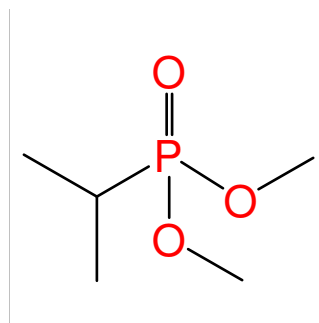

**Chemical name:** Cyclohexyl ethylphosphonochloridate

Schedule: 2B04

CAS RN: 57523-33-8

HS code: 2931.39

Key: 57523-33-8

Molecular formula: C<sub>8</sub>H<sub>16</sub>ClO<sub>2</sub>P

CAS Index Name: Phosphonochloridic acid, ethyl-, cyclohexyl ester

**IUPAC name:** Cyclohexyl ethylphosphonochloridoate

Synonyms: O-Cyclohexyl ethylphosphonochloridate

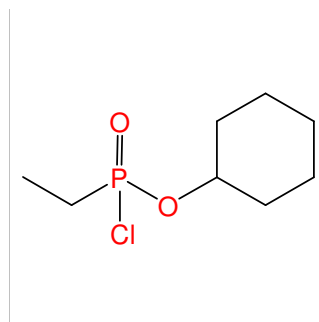

**Chemical name:** Bis(1-ethylpropyl) methylphosphonate

Schedule: 2B04

CAS RN: 5828-67-1

HS code: 2931.39

Key: 5828-67-1

Molecular formula: C<sub>11</sub>H<sub>25</sub>O<sub>3</sub>P

CAS Index Name: Phosphonic acid, methyl-, bis(1-ethylpropyl) ester

**IUPAC name:** Bis(1-ethylpropyl) methylphosphonate

Synonyms: O,O-Bis(1-ethylpropyl) methylphosphonate

Bis(pentan-3-yl) methylphosphonate

Bis(pent-3-yl) methylphosphonate

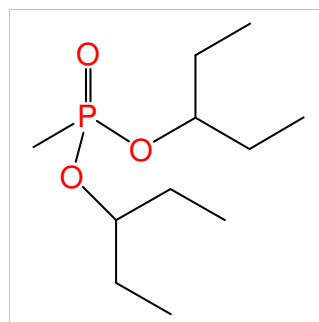

**Chemical name:** Dibutyl methylphosphonite

Schedule: 2B04

CAS RN: 59360-02-0

HS code: 2931.39

Key: 59360-02-0

Molecular formula: C<sub>9</sub>H<sub>21</sub>O<sub>2</sub>P

CAS Index Name: Phosphonous acid, methyl-, dibutyl ester

**IUPAC name:** Dibutyl methylphosphonite

Synonyms:

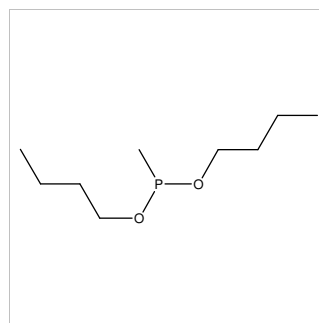

**Chemical name:** Methylphosphonothioic acid

Schedule: 2B04

CAS RN: 5994-73-0

HS code: 2930.90

Key: 5994-73-0

Molecular formula: CH<sub>5</sub>O<sub>2</sub>PS

CAS Index Name: Phosphonothioic acid, methyl-

**IUPAC name:** Methylphosphonothioic O,O-acid

Synonyms: Methanephosphonic acid, thio-

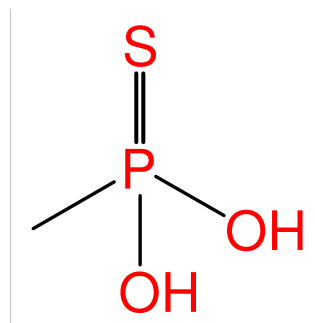

**Chemical name:** Bis(2-ethylhexyl) methylphosphonate

Schedule: 2B04

CAS RN: 60556-68-5

HS code: 2931.39

Key: 60556-68-5

Molecular formula: C<sub>17</sub>H<sub>37</sub>O<sub>3</sub>P

CAS Index Name: Phosphonic acid, methyl-, bis(2-ethylhexyl)ester

**IUPAC name:** Bis(2-ethylhexyl) methylphosphonate

Synonyms: O,O-Bis(2-ethylhexyl) methylphosphonate

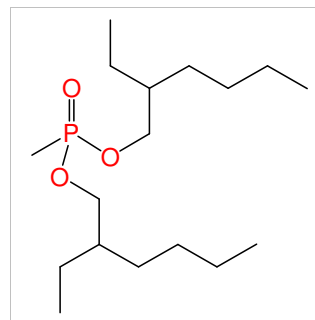

**Chemical name:** Bis(2-methoxyethyl) methylphosphonate

Schedule: 2B04

CAS RN: 6069-09-6

HS code: 2931.39

Key: 6069-09-6

Molecular formula: C<sub>7</sub>H<sub>17</sub>O<sub>5</sub>P

CAS Index Name: Phosphonic acid, methyl-, bis(2-methoxyethyl) ester

**IUPAC name:** Bis(2-methoxyethyl) methylphosphonate

Synonyms: O,O-bis(2-methoxyethyl) methylphosphonate

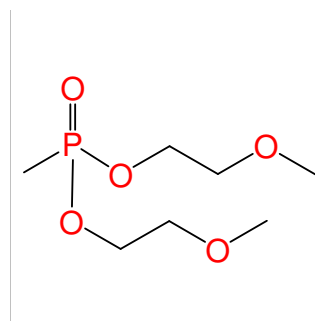

**Chemical name:** Dioctyl ethylphosphonate

Schedule: 2B04

CAS RN: 6156-13-4

HS code: 2931.39

Key: 6156-13-4

Molecular formula: C<sub>18</sub>H<sub>39</sub>O<sub>3</sub>P

CAS Index Name: Phosphonic acid, ethyl-, dioctyl ester

**IUPAC name:** Dioctyl ethylphosphonate

Synonyms: O,O-Dioctyl ethylphosphonate

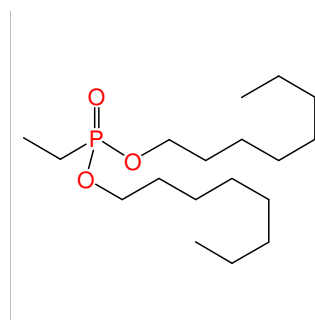

**Chemical name:** Dimethyl ethylphosphonate

Schedule: 2B04

CAS RN: 6163-75-3

HS code: 2931.39

Key: 6163-75-3

Molecular formula: C<sub>4</sub>H<sub>11</sub>O<sub>3</sub>P

CAS Index Name: Phosphonic acid, ethyl-, dimethyl ester

**IUPAC name:** Dimethyl ethylphosphonate

Synonyms:

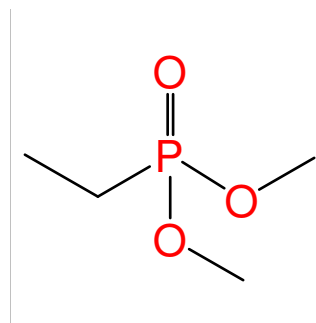

**Chemical name:** Pinacolyl methylphosphonate

Schedule: 2B04

CAS RN: 616-52-4

HS code: 2931.39

Key: 616-52-4

Molecular formula: C<sub>7</sub>H<sub>17</sub>O<sub>3</sub>P

CAS Index Name: Phosphonic acid, methyl-, mono(1,2,2-trimethylpropyl) ester

**IUPAC name:** 1,2,2-Trimethylpropyl methylphosphonate

Synonyms: 3,3-Dimethylbutan-2-yl methylphosphonate

3,3-Dimethylbut-2-yl methylphosphonate

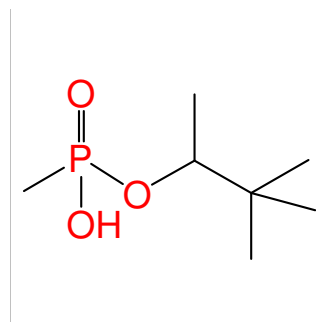

**Chemical name:** Butyl methylphosphinate

Schedule: 2B04

CAS RN: 6172-80-1

HS code: 2931.39

Key: 6172-80-1

Molecular formula: C<sub>5</sub>H<sub>13</sub>O<sub>2</sub>P

CAS Index Name: Phosphinic acid, methyl-, butyl ester

**IUPAC name:** Butyl methylphosphinate

Synonyms: Butyl methanephosphinite

Butyl methanephosphinate

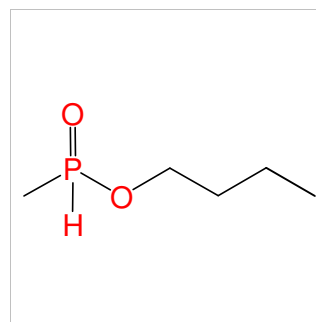

**Chemical name:** Diethyl isopropylphosphonite

Schedule: 2B04

CAS RN: 61820-31-3

HS code: 2931.39

Key: 61820-31-3

Molecular formula: C<sub>7</sub>H<sub>17</sub>O<sub>2</sub>P

CAS Index Name: Phosphonous acid, (1-methylethyl)-, diethyl ester

**IUPAC name:** Diethyl isopropylphosphonite

Synonyms:

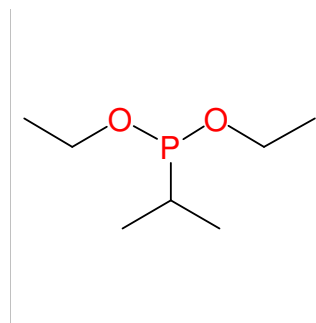



**Chemical name:** 2-Methyl-1,3,2-dioxaphosphepane-2-oxide

Schedule: 2B04

CAS RN: 63299-52-5

HS code: 2931.39

Key: 63299-52-5

Molecular formula: C<sub>5</sub>H<sub>11</sub>O<sub>3</sub>P

CAS Index Name: 1,3,2-Dioxaphosphepane, 2-methyl-, 2-oxide

**IUPAC name:**

Synonyms:

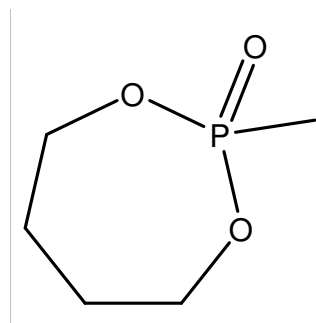

**Chemical name:** Poly(1,3-phenylene methyl phosphonate)

Schedule: 2B04

CAS RN: 63747-58-0

HS code: 3911.90

Key: 63747-58-0

Molecular formula: (C<sub>13</sub>H<sub>13</sub>O<sub>3</sub>P.C<sub>6</sub>H<sub>6</sub>O<sub>2</sub>)<sub>x</sub>

CAS Index Name: Phosphonic acid, P-methyl-, diphenyl ester, polymer with 1,3-benzenediol

**IUPAC name:**

Synonyms: Phosphonic acid, methyl-, diphenyl ester, polymer with 1,3-benzenediol

Diphenyl methylphosphonate-resorcinol copolymer

1,3-Benzenediol, polymer with diphenyl methylphosphonate

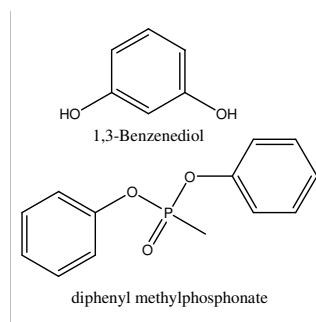

**Chemical name:** Diisopropyl methylphosphonite

Schedule: 2B04

CAS RN: 66295-44-1

HS code: 2931.39

Key: 66295-44-1

Molecular formula: C<sub>7</sub>H<sub>17</sub>O<sub>2</sub>P

CAS Index Name: Phosphonous acid, P-methyl-, bis(1-methylethyl) ester

**IUPAC name:** Diisopropyl methylphosphonite (IUPAC)

Synonyms: Phosphonous acid, methyl-, diisopropyl ester

Phosphonous acid, methyl-, bis(1-methylethyl) ester

Diisopropyl methylphosphonite

(Diisopropoxymethyl)phosphine

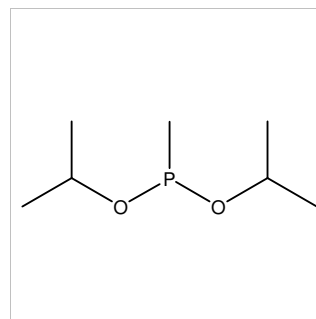

**Chemical name:** Phosphonic acid, methyl-, polyglycol ester (Exolit OP 560)

Schedule: 2B04

CAS RN: 663176-00-9

HS code: 3824.99

Key: 663176-00-9

Molecular formula: Unspecified

CAS Index Name: Phosphonic acid, methyl-, polyglycol ester

**IUPAC name:**

Synonyms: Exolit OP 560

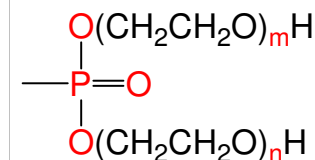

**Chemical name:** O-Propyl ethylphosphinothionate

Schedule: 2B04

CAS RN: 67397-57-3

HS code: 2930.90

Key: 67397-57-3

Molecular formula: C<sub>5</sub>H<sub>13</sub>OPS

CAS Index Name: Phosphinothioic acid, P-ethyl-, O-propyl ester

**IUPAC name:**

Synonyms:

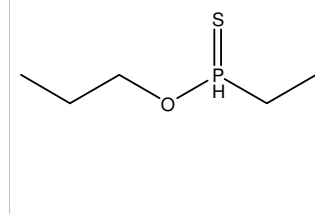

**Chemical name:** Methylphosphonous dichloride

Schedule: 2B04

CAS RN: 676-83-5

HS code: 2931.39

Key: 676-83-5

Molecular formula: CH<sub>3</sub>Cl<sub>2</sub>P

CAS Index Name: Phosphonous dichloride, methyl-

**IUPAC name:** Methylphosphonous dichloride

Synonyms: Phosphine, dichloromethyl-  
Methylphosphorus dichloride  
Methylphosphinous dichloride  
Methylphosphinic dichloride  
Methyldichlorophosphine  
Dichloromethylphosphine

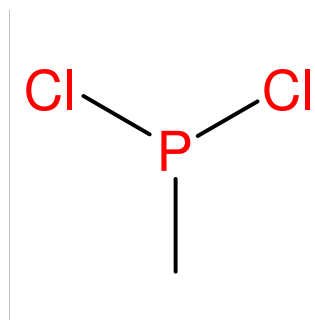

**Chemical name:** Methylphosphonic dichloride

Schedule: 2B04

CAS RN: 676-97-1

HS code: 2931.39

Key: 676-97-1

Molecular formula: CH<sub>3</sub>Cl<sub>2</sub>OP

CAS Index Name: Phosphonic dichloride, methyl-

**IUPAC name:** Methylphosphonic dichloride

**Synonyms:** Methylphosphonyl dichloride  
Methylphosphonyl chloride  
Methylphosphonodichloridic acid  
Methylphosphonic acid dichloride  
Methanephosphonyl dichloride  
Methanephosphonyl chloride  
Methanephosphonodichloridic acid  
Dichloromethylphosphine oxide  
DC

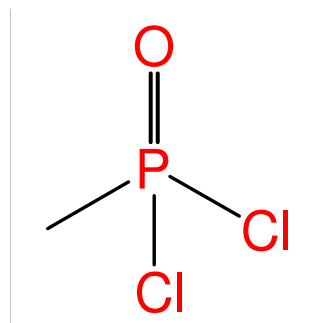

**Chemical name:** Methylphosphonothioic dichloride

Schedule: 2B04

CAS RN: 676-98-2

HS code: 2931.39

Key: 676-98-2

Molecular formula: CH<sub>3</sub>Cl<sub>2</sub>PS

CAS Index Name: Phosphonothioic dichloride, methyl-

**IUPAC name:** Methylphosphonothioic dichloride

**Synonyms:** Methylthiophosphonic dichloride  
Methylthiophosphonic acid dichloride  
Methylthionophosphonic dichloride  
Methylphosphonothioyl dichloride  
Methyldichlorophosphine sulfide  
Methanephosphonothioic dichloride  
Dichloromethylphosphine sulfide

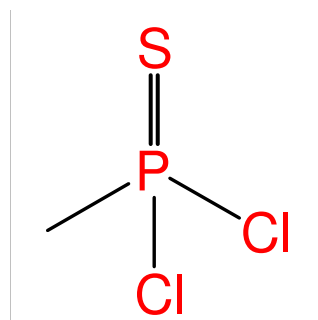

**Chemical name:** Ethylphosphonic acid

Schedule: 2B04

CAS RN: 6779-09-5

HS code: 2931.39

Key: 6779-09-5

Molecular formula: C<sub>2</sub>H<sub>7</sub>O<sub>3</sub>P

CAS Index Name: Phosphonic acid, ethyl-

**IUPAC name:** Ethylphosphonic acid

Synonyms: Ethanephosphonic acid

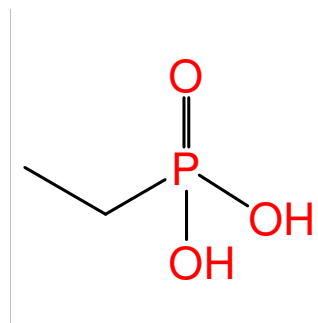

**Chemical name:** Methyl 3-(trimethoxysilyl)propyl methylphosphonate

Schedule: 2B04

CAS RN: 67812-17-3

HS code: 2931.39

Key: 67812-17-3

Molecular formula: C<sub>8</sub>H<sub>21</sub>O<sub>6</sub>PSi

CAS Index Name: Phosphonic acid, methyl-, methyl 3-(trimethoxysilyl)propyl ester

**IUPAC name:** Methyl 3-(trimethoxysilyl)propyl methylphosphonate

Synonyms:

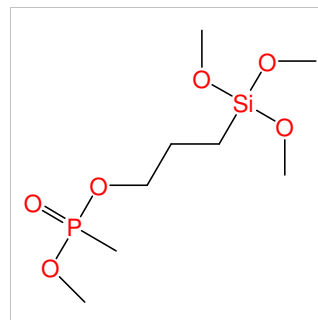

**Chemical name:** O,O-Dimethyl methylphosphonothionate

Schedule: 2B04

CAS RN: 681-06-1

HS code: 2930.90

Key: 681-06-1

Molecular formula: C<sub>3</sub>H<sub>9</sub>O<sub>2</sub>PS

CAS Index Name: Phosphonothioic acid, methyl-, O,O-dimethyl ester

**IUPAC name:** O,O-Dimethyl methylphosphonothioate

Synonyms: Dimethyl methylthionophosphonate

Dimethyl methylphosphonothionate

Dimethyl methanethiophosphonate

Dimethoxymethylphosphine sulfide

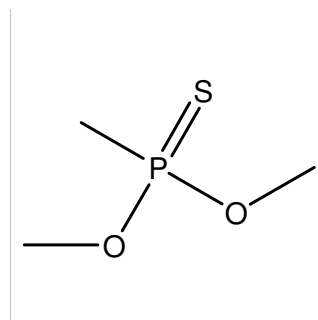

**Chemical name:** Diethyl methylphosphonate

Schedule: 2B04

CAS RN: 683-08-9

HS code: 2931.39

Key: 683-08-9

Molecular formula: C<sub>5</sub>H<sub>13</sub>O<sub>3</sub>P

CAS Index Name: Phosphonic acid, methyl-, diethyl ester

**IUPAC name:** Diethyl methylphosphonate

Synonyms: O,O-Diethyl methylphosphonate

Diethyl methanephosphonate

Diethoxymethylphosphine oxide

DEMP

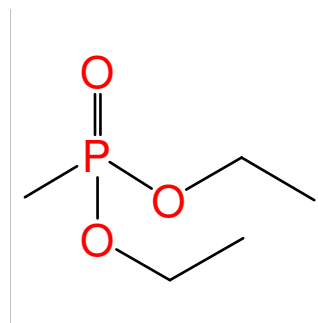

**Chemical name:** Methyl propyl methylphosphonate

Schedule: 2B04

CAS RN: 683-25-0

HS code: 2931.39

Key: 683-25-0

Molecular formula: C<sub>5</sub>H<sub>13</sub>O<sub>3</sub>P

CAS Index Name: Phosphonic acid, methyl-, methyl propyl ester

**IUPAC name:**

Synonyms:

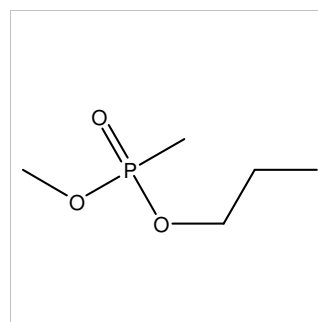

**Chemical name:** Butyl methyl methylphosphonate

Schedule: 2B04

CAS RN: 683-32-9

HS code: 2931.39

Key: 683-32-9

Molecular formula: C<sub>6</sub>H<sub>15</sub>O<sub>3</sub>P

CAS Index Name: Phosphonic acid, methyl-, butyl methyl ester

**IUPAC name:** Butyl methyl methylphosphonate

Synonyms: O-Butyl O-methyl methylphosphonate

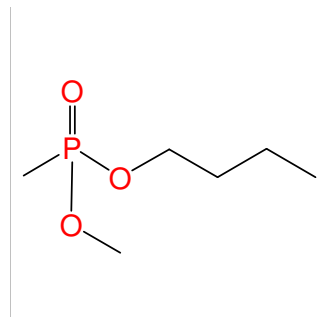

**Chemical name:** 2,4,6-Tripropyl-1,3,5,2,4,6-trioxatriphosphinane 2,4,6-trioxide

Schedule: 2B04

CAS RN: 68957-94-8

HS code: 2931.35

Key: 68957-94-8

Molecular formula: C<sub>9</sub>H<sub>21</sub>O<sub>6</sub>P<sub>3</sub>

CAS Index Name: 1,3,5,2,4,6-Trioxatriphosphorinane, 2,4,6-tripropyl-, 2,4,6-trioxide

**IUPAC name:** 2,4,6-Tripropyl-1,3,5,2,4,6-trioxatriphosphinane 2,4,6-trioxide

Synonyms: Propylphosphonic anhydride

n-Propylphosphonic cyclic anhydride

1-Propanephosphonic acid cyclic anhydride, 50% in ethyl acetate

1-Propanephosphonic acid cyclic anhydride

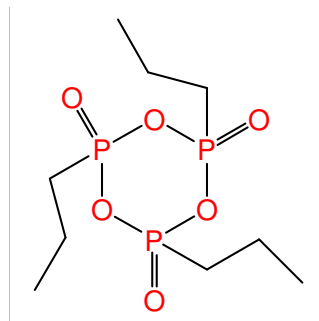

**Chemical name:** Isopropyl methyl methylphosphonate

Schedule: 2B04

CAS RN: 690-64-2

HS code: 2931.39

Key: 690-64-2

Molecular formula: C<sub>5</sub>H<sub>13</sub>O<sub>3</sub>P

CAS Index Name: Phosphonic acid, methyl-, methyl 1-methylethyl ester

**IUPAC name:** Isopropyl methyl methylphosphonate

Synonyms:

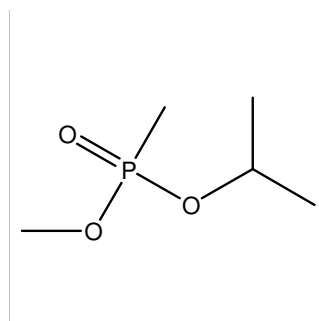

**Chemical name:** O,O-Diethyl methylphosphonothionate

Schedule: 2B04

CAS RN: 6996-81-2

HS code: 2930.90

Key: 6996-81-2

Molecular formula: C<sub>5</sub>H<sub>13</sub>O<sub>2</sub>PS

CAS Index Name: Phosphonothioic acid, methyl-, O,O-diethyl ester

**IUPAC name:** O,O-Diethyl methylphosphonothioate

Synonyms: Diethoxy(methyl)phosphine sulfide

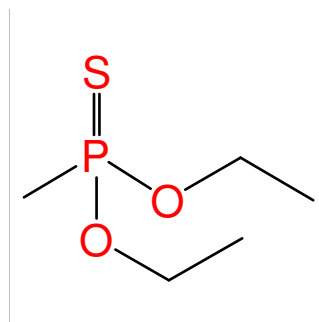

**Chemical name:** N,N,N-trimethyl-3-[(1-oxo-9-octadecenyl)amino]methyl methylphosphonate propan-1-aminium

Schedule: 2B04

CAS RN: 70055-71-9

HS code: 2931.39

Key: 70055-71-9

Molecular formula: C<sub>24</sub>H<sub>49</sub>N<sub>2</sub>O.C<sub>2</sub>H<sub>6</sub>O<sub>3</sub>P

CAS Index Name: 1-Propanaminium, N,N,N-trimethyl-3-[(1-oxo-9-octadecenyl)amino]-, (Z)-, methyl methylphosphonate

**IUPAC name:** N,N,N-trimethyl-3-[(1-oxo-9-octadecenyl)amino]methyl methylphosphonate propan-1-aminium

Synonyms:

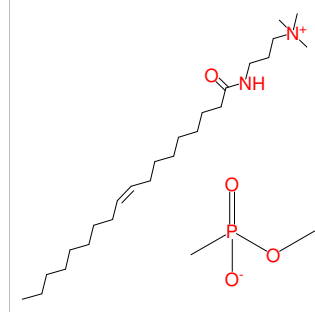

**Chemical name:** Cyclohexyl methyl methylphosphonate

Schedule: 2B04

CAS RN: 7040-52-0

HS code: 2931.39

Key: 7040-52-0

Molecular formula: C<sub>8</sub>H<sub>17</sub>O<sub>3</sub>P

CAS Index Name: Phosphonic acid, methyl-, cyclohexyl methyl ester

**IUPAC name:** Cyclohexyl methyl methylphosphonate

Synonyms:

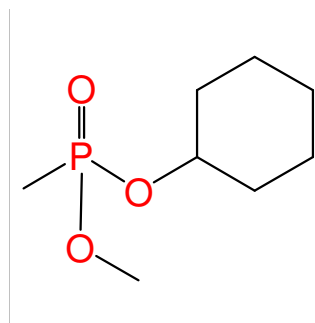

**Chemical name:** Dicyclohexyl methylphosphonate

Schedule: 2B04

CAS RN: 7040-53-1

HS code: 2931.39

Key: 7040-53-1

Molecular formula: C<sub>13</sub>H<sub>25</sub>O<sub>3</sub>P

CAS Index Name: Phosphonic acid, methyl-, dicyclohexyl ester

**IUPAC name:** Dicyclohexyl methylphosphonate

Synonyms: O,O-Dicyclohexyl methylphosphonate

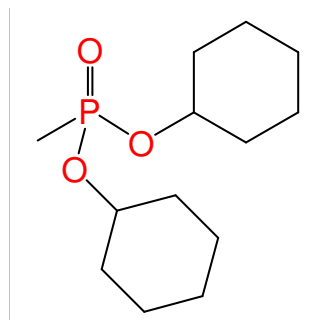

**Chemical name:** Dipinacolyl methylphosphonate

Schedule: 2B04

CAS RN: 7040-58-6

HS code: 2931.39

Key: 7040-58-6

Molecular formula: C<sub>13</sub>H<sub>29</sub>O<sub>3</sub>P

CAS Index Name: Phosphonic acid, methyl-, bis(1,2,2-trimethylpropyl) ester

**IUPAC name:** Bis(1,2,2-trimethylpropyl) methylphosphonate

Synonyms: O,O-Bis(1,2,2-trimethylpropyl) methylphosphonate

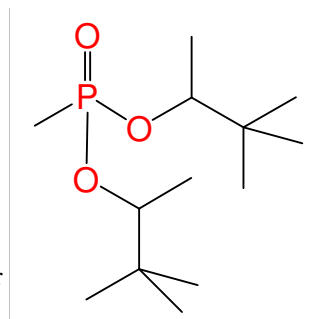

**Chemical name:** Methyl pinacolyl methylphosphonate

Schedule: 2B04

CAS RN: 7040-59-7

HS code: 2931.39

Key: 7040-59-7

Molecular formula: C<sub>8</sub>H<sub>19</sub>O<sub>3</sub>P

CAS Index Name: Phosphonic acid, methyl-, methyl 1,2,2-trimethylpropyl ester

**IUPAC name:** Methyl 1,2,2-trimethylpropyl methylphosphonate

Synonyms: O-Methyl O-pinacolyl methylphosphonate

Methyl 3,3-dimethylbutan-2-yl methylphosphonate

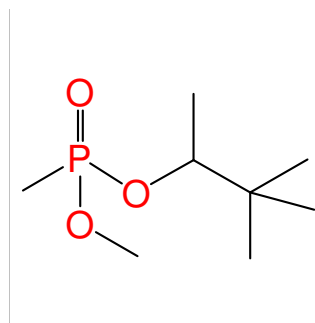

**Chemical name:** Cyclohexyl methylphosphonochloridate

Schedule: 2B04

CAS RN: 7040-92-8

HS code: 2931.39

Key: 7040-92-8

Molecular formula: C<sub>7</sub>H<sub>14</sub>ClO<sub>2</sub>P

CAS Index Name: Phosphonochloridic acid, methyl-, cyclohexyl ester

**IUPAC name:** Cyclohexyl methylphosphonochloridoate

Synonyms: O-Cyclohexyl methylphosphonochloridate

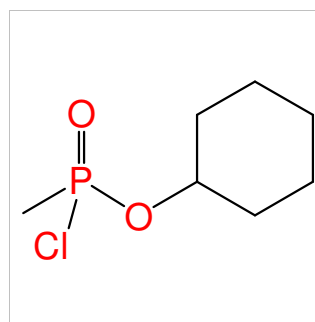

**Chemical name:** Dimethylmethylphosphonate, polymer with oxirane and phosphorus oxide

Schedule: 2B04

CAS RN: 70715-06-9

HS code: 3824.99

Key: 70715-06-9

Molecular formula: (C<sub>3</sub>H<sub>9</sub>O<sub>3</sub>P.C<sub>2</sub>H<sub>4</sub>O.O<sub>5</sub>P<sub>2</sub>)X

CAS Index Name: Phosphonic acid, methyl-, dimethyl ester, polymer with oxirane and phosphorus oxide(P<sub>2</sub>O<sub>5</sub>)

**IUPAC name:**

Synonyms: Phosphorus oxide, polymer with dimethyl methylphosphonate and oxirane

Fyroltex HP

Fyrol 51

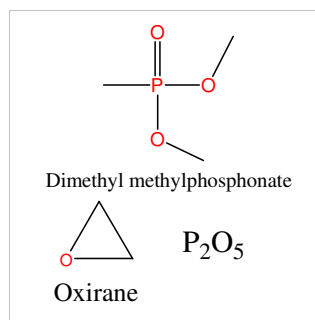



**Chemical name:** Bis(1-methacryloxy-2-chloro-propyl) methylphosphonate

Schedule: 2B04

CAS RN: 71097-47-7

HS code: 2931.39

Key: 71097-47-7

Molecular formula: C<sub>15</sub>H<sub>23</sub>Cl<sub>2</sub>O<sub>7</sub>P

CAS Index Name: 2-Propenoic acid, 2-methyl-, (methylphosphinylidene)bis[oxy(2-chloro-3,1-propanediyl)] ester

**IUPAC name:** 1,7-dichloro-2,4,6,10-tetramethyl-4-oxido-9-oxo-3,5,8-trioxa-4(λ<sup>5</sup>)-phosphaundec-10-en-1-yl 2-

Synonyms: Bis(1-methacryloxy-3-chloro-2-propyl) methylphosphonate

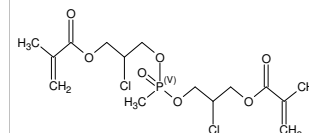

**Chemical name:** Dipropyldiphosphonic acid

Schedule: 2B04

CAS RN: 71760-04-8

HS code: 2931.39

Key: 71760-04-8

Molecular formula: C<sub>6</sub>H<sub>16</sub>O<sub>5</sub>P<sub>2</sub>

CAS Index Name: Diphosphonic acid, dipropyl-

**IUPAC name:** Dipropyldiphosphonic acid

Synonyms: Propanephosphonic anhydride  
Propanephosphonic acid anhydride

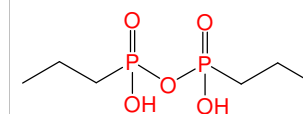

**Chemical name:** O,O-Diisobutyl methylphosphonate

Schedule: 2B04

CAS RN: 7242-56-0

HS code: 2931.39

Key: 7242-56-0

Molecular formula: C<sub>9</sub>H<sub>21</sub>O<sub>3</sub>P

CAS Index Name: Phosphonic acid, P-methyl-, bis(2-methylpropyl) ester

**IUPAC name:**

Synonyms:

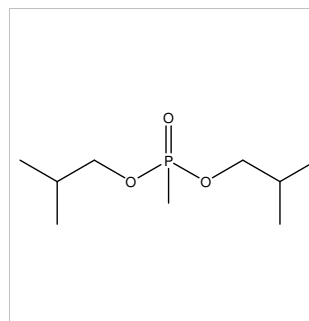

**Chemical name:** Ethyl ethylphosphonate

Schedule: 2B04

CAS RN: 7305-61-5

HS code: 2931.39

Key: 7305-61-5

Molecular formula: C<sub>4</sub>H<sub>11</sub>O<sub>3</sub>P

CAS Index Name: Phosphonic acid, ethyl-, monoethyl ester

**IUPAC name:** Ethyl ethylphosphonate

Synonyms: O-Ethyl ethylphosphonate

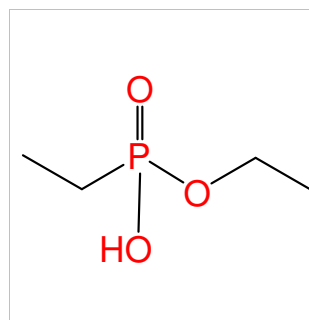

**Chemical name:** S-Methyl methylphosphonothiolate

Schedule: 2B04

CAS RN: 73675-56-6

HS code: 2930.90

Key: 73675-56-6

Molecular formula: C<sub>2</sub>H<sub>7</sub>O<sub>2</sub>PS

CAS Index Name: Phosphonothioic acid, methyl-, S-methyl ester

**IUPAC name:** S-Methyl methylphosphonothioate

Synonyms:

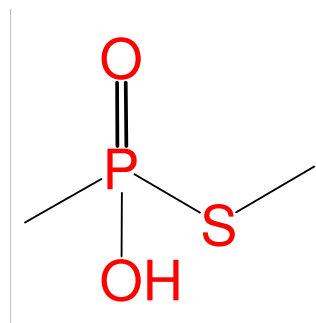

**Chemical name:** Sodium methyl methylphosphonate

Schedule: 2B04

CAS RN: 73750-69-3

HS code: 2931.39

Key: 73750-69-3

Molecular formula: C<sub>2</sub>H<sub>6</sub>O<sub>3</sub>P.Na

CAS Index Name: Phosphonic acid, P-methyl, monomethyl ester, sodium salt (1:1)

**IUPAC name:**

Synonyms: Phosphonic acid, methyl-, monomethyl ester, monosodium salt

Phosphonic acid, methyl-, methyl ester, sodium salt

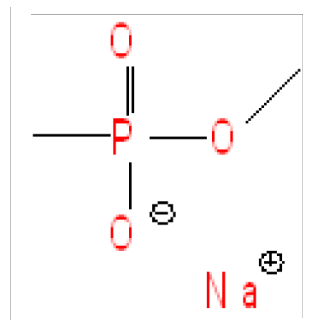

**Chemical name:** Ethyl S-dicyclohexylammonium methylphosphonothiolate

Schedule: 2B04

CAS RN: 73790-51-9

HS code: 2930.90

Key: 73790-51-9

Molecular formula: C<sub>15</sub>H<sub>32</sub>NO<sub>2</sub>PS

CAS Index Name: Phosphonothioic acid, methyl-, O-ethyl ester, compd. with N-cyclohexylcyclohexamine (1:1)

**IUPAC name:**

Synonyms: Phosphonothioic acid, methyl-, O-ethyl ester, compd. with dicyclohexylamine

O-Ethyl methylphosphonothioic acid, dicyclohexylammonium salt

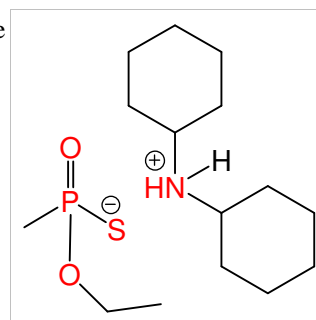

**Chemical name:** Methyl propyl isopropylphosphonate

Schedule: 2B04

CAS RN: 741700-63-0

HS code: 2931.39

Key: 741700-63-0

Molecular formula: C<sub>7</sub>H<sub>17</sub>O<sub>3</sub>P

CAS Index Name: Phosphonic acid, (1-methylethyl)-, methyl propyl ester

**IUPAC name:** Methyl propyl isopropylphosphonate

Synonyms: O-Methyl O-propyl isopropylphosphonate

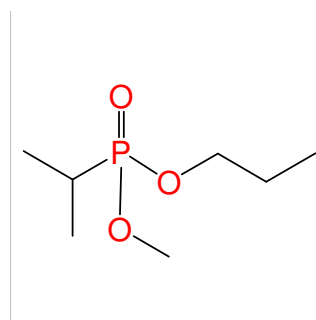

**Chemical name:** Propyl isopropylphosphonate

Schedule: 2B04

CAS RN: 741700-67-4

HS code: 2931.39

Key: 741700-67-4

Molecular formula: C<sub>6</sub>H<sub>15</sub>O<sub>3</sub>P

CAS Index Name: Phosphonic acid, (1-methylethyl)-, monopropyl ester

**IUPAC name:** Propyl isopropylphosphonate

Synonyms: O-Propyl isopropylphosphonate

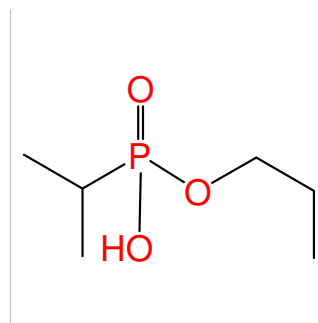

**Chemical name:** Methyl 2-methylcyclohexyl methylphosphonate

Schedule: 2B04

CAS RN: 745809-81-8

HS code: 2931.39

Key: 745809-81-8

Molecular formula: C<sub>9</sub>H<sub>19</sub>O<sub>3</sub>P

CAS Index Name: Phosphonic acid, methyl-, methyl 2-methylcyclohexyl ester (9CI)

**IUPAC name:**

Synonyms: O-methyl )-2-methylcyclohexyl methylphosphonat

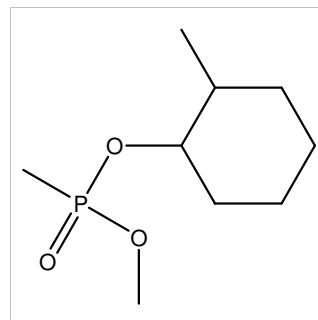

**Chemical name:** Methyl S-sodium methylphosphonothiolate

Schedule: 2B04

CAS RN: 74789-31-4

HS code: 2930.90

Key: 74789-31-4

Molecular formula: C<sub>2</sub>H<sub>6</sub>NaO<sub>2</sub>PS

CAS Index Name: Phosphonothioic acid, methyl-, O-methyl ester, sodium salt

**IUPAC name:** Sodium O-methyl methylphosphonothioate

Synonyms: Sodium O-methyl methylphosphonothiolate

O-Methyl S-sodium methylphosphonothiolate

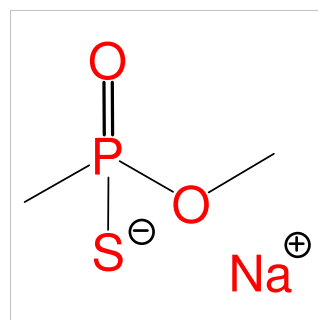

**Chemical name:** Isobutyl S-sodium methylphosphonothiolate

Schedule: 2B04

CAS RN: 74789-32-5

HS code: 2930.90

Key: 74789-32-5

Molecular formula: C<sub>5</sub>H<sub>12</sub>NaO<sub>2</sub>PS

CAS Index Name: Phosphonothioic acid, methyl-, O-(2-methylpropyl) ester, sodium salt

**IUPAC name:** Sodium O-isobutyl methylphosphonothioate

Synonyms: Sodium O-isobutyl methylphosphonothiolate

O-Isobutyl S-sodium methylphosphonothiolate

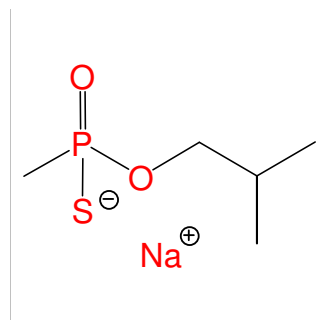

**Chemical name:** Diphenyl methylphosphonate

Schedule: 2B04

CAS RN: 7526-26-3

HS code: 2931.39

Key: 7526-26-3

Molecular formula: C<sub>13</sub>H<sub>13</sub>O<sub>3</sub>P

CAS Index Name: Phosphonic acid, methyl-, diphenyl ester

**IUPAC name:** Diphenyl methylphosphonate

Synonyms: Diphenyl methanephosphonate

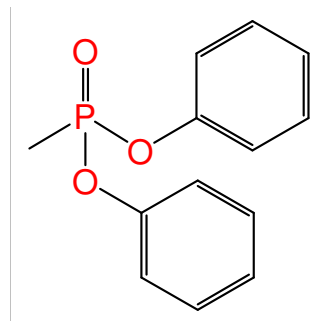

**Chemical name:** Methylthiophosphonyl difluoride

Schedule: 2B04

CAS RN: 753-72-0

HS code: 2930.90

Key: 753-72-0

Molecular formula: CH<sub>3</sub>F<sub>2</sub>PS

CAS Index Name: Phosphonothioic difluoride, methyl-

**IUPAC name:** Difluoromethylphosphine sulfide

Synonyms: Methylphosphonothioic difluoride

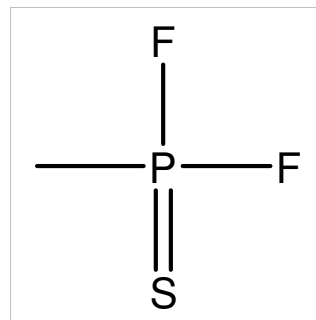

**Chemical name:** Dimethyl methylphosphonate

Schedule: 2B04

CAS RN: 756-79-6

HS code: 2931.31

Key: 756-79-6

Molecular formula: C<sub>3</sub>H<sub>9</sub>O<sub>3</sub>P

CAS Index Name: Phosphonic acid, methyl-, dimethyl ester

**IUPAC name:** Dimethyl methylphosphonate

Synonyms: Reoflam DMMP

O,O-Dimethyl methylphosphonate

NSC 62240

Methylphosphonic acid dimethyl ester

Methanephosphonic acid dimethyl ester

Metaran

Fyrol DMMP

Fran TF 2000

DMMP

Dimethyl methanephosphonate

Dimethoxymethyl phosphine oxide

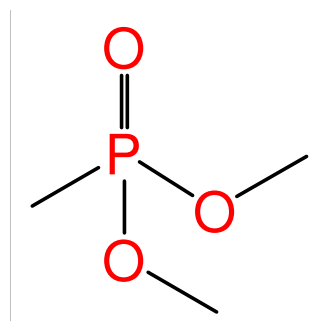

**Chemical name:** Bis(2,2,2-trifluoroethyl) methylphosphonate

Schedule: 2B04

CAS RN: 757-95-9

HS code: 2931.39

Key: 757-95-9

Molecular formula: C<sub>5</sub>H<sub>7</sub>F<sub>6</sub>O<sub>3</sub>P

CAS Index Name: Phosphonic acid, P-methyl-, bis(2,2,2-trifluoroethyl) ester

**IUPAC name:** Bis(2,2,2-trifluoroethyl) methylphosphonate

Synonyms: Phosphonic acid, methyl-, bis(2,2,2-trifluoroethyl) ester

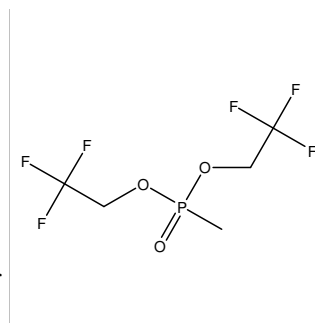

**Chemical name:** Bis(1-methylheptyl) methylphosphonate

Schedule: 2B04

CAS RN: 76341-63-4

HS code: 2931.39

Key: 76341-63-4

Molecular formula: C<sub>17</sub>H<sub>37</sub>O<sub>3</sub>P

CAS Index Name: Phosphonic acid, methyl-, bis(1-methylheptyl) ester

**IUPAC name:** Bis(1-methylheptyl) methylphosphonate

Synonyms: Bis(octan-2-yl) methylphosphonate

Bis(oct-2-yl) methylphosphonate

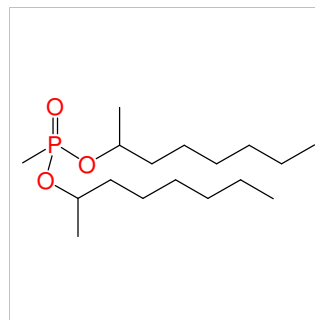

**Chemical name:** Dihexyl methylphosphonate

Schedule: 2B04

CAS RN: 77304-63-3

HS code: 2931.39

Key: 77304-63-3

Molecular formula: C<sub>13</sub>H<sub>29</sub>O<sub>3</sub>P

CAS Index Name: Phosphonic acid, methyl-, dihexyl ester

**IUPAC name:** Dihexyl methylphosphonate

Synonyms:

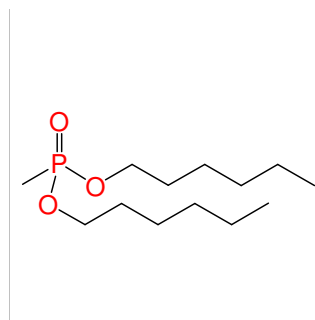

**Chemical name:** Diheptyl methylphosphonate

Schedule: 2B04

CAS RN: 77304-64-4

HS code: 2931.39

Key: 77304-64-4

Molecular formula: C<sub>15</sub>H<sub>33</sub>O<sub>3</sub>P

CAS Index Name: Phosphonic acid, methyl-, diheptyl ester

**IUPAC name:** Diheptyl methylphosphonate

Synonyms:

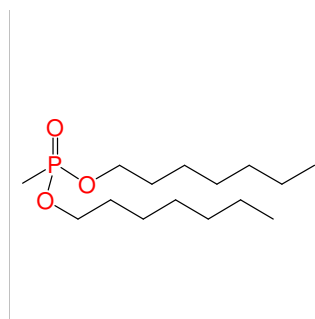

**Chemical name:** Octyl propylphosphonate

Schedule: 2B04

CAS RN: 781566-65-2

HS code: 2931.39

Key: 781566-65-2

Molecular formula: C<sub>11</sub>H<sub>25</sub>O<sub>3</sub>P

CAS Index Name: Phosphonic acid, propyl-, mono-octyl ester

**IUPAC name:** Octyl propylphosphonate

Synonyms: O-Octyl propylphosphonate

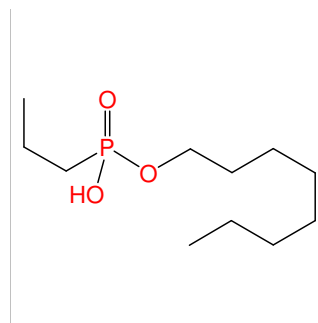

**Chemical name:** Diethyl ethylphosphonate

Schedule: 2B04

CAS RN: 78-38-6

HS code: 2931.33

Key: 78-38-6

Molecular formula: C<sub>6</sub>H<sub>15</sub>O<sub>3</sub>P

CAS Index Name: Phosphonic acid, ethyl-, diethyl ester

**IUPAC name:** Diethyl ethylphosphonate

Synonyms: Diethyl ethanephosphonate

Diethoxyethylphosphine oxide

Amgard V 490

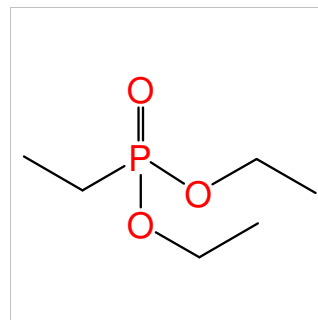

**Chemical name:** O,O-Dimethyl methylphosphonothioate-d<sub>3</sub>

Schedule: 2B04

CAS RN: 80014-33-1

HS code: 2845.90

Key: 80014-33-1

Molecular formula: C<sub>3</sub>H<sub>6</sub>D<sub>3</sub>O<sub>2</sub>PS

CAS Index Name: Phosphonic acid, methyl-d<sub>3</sub>-, dimethyl ester

**IUPAC name:**

Synonyms:

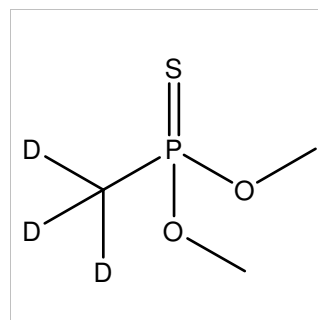

**Chemical name:** Dipinacolyl dimethylpyrophosphonate

Schedule: 2B04

CAS RN: 81397-56-0

HS code: 2931.39

Key: 81397-56-0

Molecular formula: C<sub>14</sub>H<sub>32</sub>O<sub>5</sub>P<sub>2</sub>

CAS Index Name: Diphosphonic acid, dimethyl-, bis(1,2,2-trimethylpropyl) ester

**IUPAC name:** Dipinacolyl dimethyldiphosphonate

Synonyms:

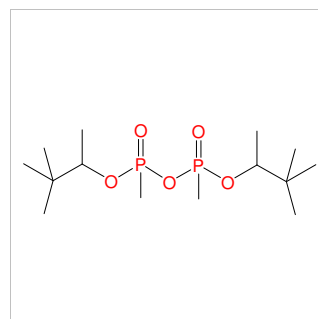

**Chemical name:** Dioctyl isopropylphosphonate

Schedule: 2B04

CAS RN: 83218-22-8

HS code: 2931.39

Key: 83218-22-8

Molecular formula: C<sub>19</sub>H<sub>41</sub>O<sub>3</sub>P

CAS Index Name: Phosphonic acid, (1-methylethyl)-, dioctyl ester

**IUPAC name:** Dioctyl isopropylphosphonate

Synonyms: O,O-Dioctyl isopropylphosphonate

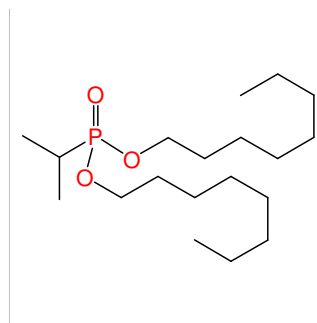

**Chemical name:** Methylphosphonic acid with (aminoiminomethyl)urea (1:1)

Schedule: 2B04

CAS RN: 84402-58-4

HS code: 2931.38

Key: 84402-58-4

Molecular formula: C<sub>2</sub>H<sub>6</sub>N<sub>4</sub>O.CH<sub>5</sub>O<sub>3</sub>P

CAS Index Name: Phosphonic acid, P-methyl-, compd. with N-(aminoiminomethyl)urea (1:1)

**IUPAC name:**

Synonyms: Methylphosphonic acid/(aminoiminomethyl)urea (1:1)

Methylphosphonic acid compound with (aminoiminomethyl)urea (1:1)

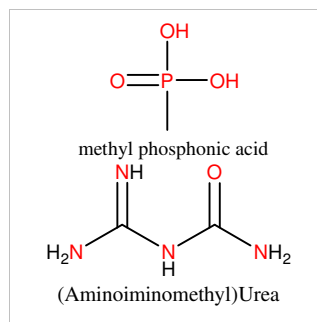

**Chemical name:** O-(3-chloropropyl) O-[4-nitro-3-(trifluoromethyl)phenyl] methylphosphonothionate

Schedule: 2B04

CAS RN: 849-29-6

HS code: 2931.39

Key: 849-29-6

Molecular formula: C<sub>11</sub>H<sub>12</sub>ClF<sub>3</sub>NO<sub>4</sub>PS

CAS Index Name: Phosphonothioic acid, methyl-, O-(3-chloropropyl) O-(.alpha.,.alpha.,.alpha.-trifluoro-4-nitro-m-tolyl) ester

**IUPAC name:**

Synonyms:

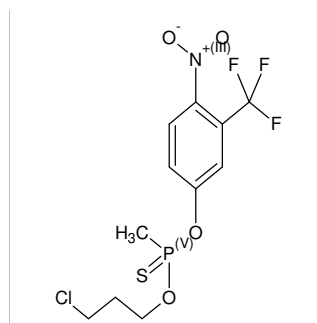

**Chemical name:** Sodium 3-(trihydroxysilyl)propyl methylphosphonate

Schedule: 2B04

CAS RN: 84962-98-1

HS code: 2931.34

Key: 84962-98-1

Molecular formula: C<sub>4</sub>H<sub>12</sub>NaO<sub>6</sub>PSi

CAS Index Name: Phosphonic acid, methyl-, mono[3-(trihydroxysilyl)propyl] ester, monosodium salt

**IUPAC name:** Sodium 3-(trihydroxysilyl)propyl methylphosphonate

Synonyms: Methylphosphonic acid mono[3-(trihydroxysilyl)propyl] ester, monosodium salt

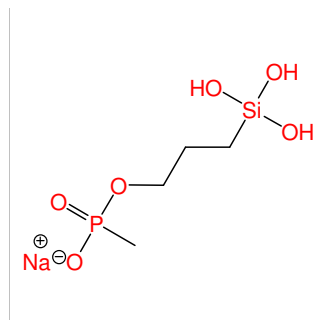

**Chemical name:** Cyclopentyl methyl methylphosphonate

Schedule: 2B04

CAS RN: 88053-17-2

HS code: 2931.39

Key: 88053-17-2

Molecular formula: C<sub>7</sub>H<sub>15</sub>O<sub>3</sub>P

CAS Index Name: Phosphonic acid, methyl-, cyclopentyl methyl ester

**IUPAC name:** Cyclopentyl methyl methylphosphonate

Synonyms:

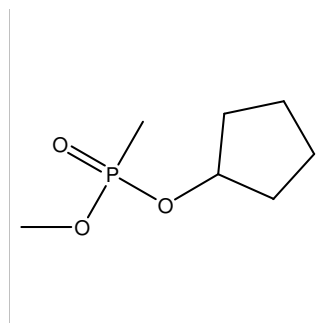

**Chemical name:** Ethyl methylphosphonite

Schedule: 2B04

CAS RN: 89034-24-2

HS code: 2931.39

Key: 89034-24-2

Molecular formula: C<sub>3</sub>H<sub>9</sub>O<sub>2</sub>P

CAS Index Name: Phosphonous acid, methyl-, monoethyl ester

**IUPAC name:** Ethyl methylphosphonite

Synonyms: Phosphonous acid, methyl-, ethyl ester

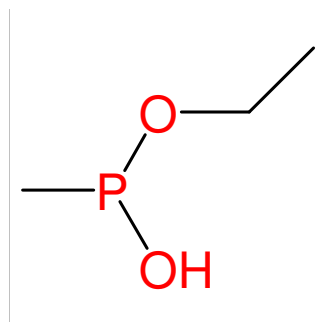

**Chemical name:** Pinacolyl propyl methylphosphonate

Schedule: 2B04

CAS RN: 90550-49-5

HS code: 2931.39

Key: 90550-49-5

Molecular formula: C<sub>10</sub>H<sub>23</sub>O<sub>3</sub>P

CAS Index Name: Phosphonic acid, methyl-, propyl 1,2,2-trimethylpropyl ester

**IUPAC name:** Propyl 1,2,2-trimethylpropyl methylphosphonate

Synonyms: O-Propyl O-(1,2,2-trimethylpropyl) methylphosphonate

3,3-Dimethylbutan-2-yl propyl methylphosphonate

3,3-Dimethylbut-2-yl propyl methylphosphonate

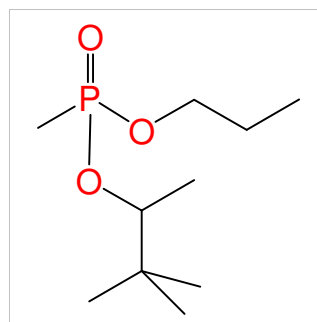

**Chemical name:** Bis(trimethylsilyl) d<sub>3</sub>-methylphosphonate

Schedule: 2B04

CAS RN: 919486-00-3

HS code: 2845.90

Key: 919486-00-3

Molecular formula: C<sub>7</sub>H<sub>18</sub>D<sub>3</sub>O<sub>3</sub>PSi<sub>2</sub>

CAS Index Name: Phosphonic acid, P-(methyl-d<sub>3</sub>)-, bis(trimethylsilyl) ester

**IUPAC name:**

Synonyms:

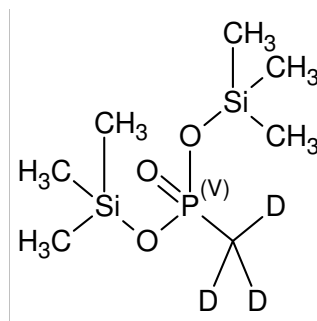



**Chemical name:** O,O-Dipentyl methylphosphonothionate

Schedule: 2B04

CAS RN: 91964-75-9

HS code: 2930.90

Key: 91964-75-9

Molecular formula: C<sub>11</sub>H<sub>25</sub>O<sub>2</sub>PS

CAS Index Name: Phosphonothioic acid, methyl-, O,O-dipentyl ester

**IUPAC name:** O,O-Dipentyl methylphosphonothioate

Synonyms: Dipentyl methylphosphonothionate

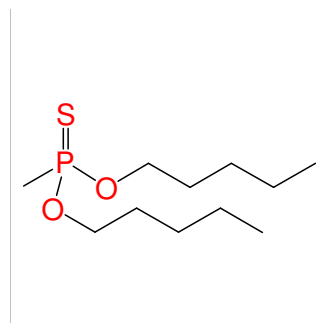

**Chemical name:** Isopropyl pinacolyl methylphosphonate

Schedule: 2B04

CAS RN: 92411-67-1

HS code: 2931.39

Key: 92411-67-1

Molecular formula: C<sub>10</sub>H<sub>23</sub>O<sub>3</sub>P

CAS Index Name: Phosphonic acid, methyl-, 1-methylethyl- 1,2,2-trimethylpropyl ester

**IUPAC name:** Isopropyl 1,2,2-trimethylpropyl methylphosphonate

Synonyms: O-Isopropyl O-(1,2,2-trimethylpropyl) methylphosphonate

Isopropyl pinacolyl methylphosphonate

Isopropyl 3,3-dimethylbutan-2-yl methylphosphonate

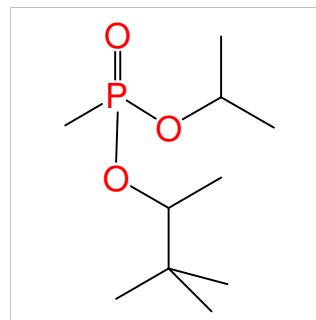

**Chemical name:** Isopropyl S-sodium methylphosphonothiolate

Schedule: 2B04

CAS RN: 92475-33-7

HS code: 2930.90

Key: 92475-33-7

Molecular formula: C<sub>4</sub>H<sub>10</sub>NaO<sub>2</sub>PS

CAS Index Name: Phosphonothioic acid, methyl-, O-(1-methylethyl) ester, sodium salt

**IUPAC name:** Sodium O-isopropyl methylphosphonothioate

Synonyms: Sodium O-isopropyl methylphosphonothiolate

Phosphonothioic acid, methyl-, O-isopropyl ester, sodium salt

O-Isopropyl S-sodium methylphosphonothiolate

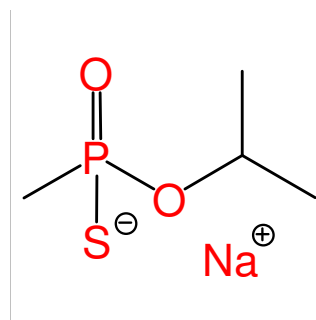

**Chemical name:** 1-Methylpentyl methylphosphonate

Schedule: 2B04

CAS RN: 944146-50-3

HS code: 2931.39

Key: 944146-50-3

Molecular formula: C<sub>7</sub>H<sub>17</sub>O<sub>3</sub>P

CAS Index Name: Phosphonic acid, methyl-, mono(1-methylpentyl) ester

**IUPAC name:** 1-Methylpentyl methylphosphonate

Synonyms: Hexan-2-yl methylphosphonate

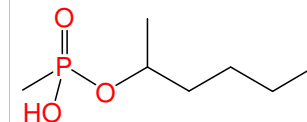

**Chemical name:** 4-Methylpentyl methylphosphonate

Schedule: 2B04

CAS RN: 944146-51-4

HS code: 2931.39

Key: 944146-51-4

Molecular formula: C<sub>7</sub>H<sub>17</sub>O<sub>3</sub>P

CAS Index Name: Phosphonic acid, methyl-, mono(4-methylpentyl) ester

**IUPAC name:** 4-Methylpentyl methylphosphonate

Synonyms: O(4-Methylpentyl) methylphosphonate

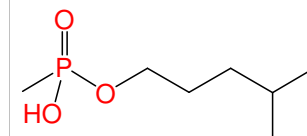

**Chemical name:** Dinonyl methylphosphonate

Schedule: 2B04

CAS RN: 95428-88-9

HS code: 2931.39

Key: 95428-88-9

Molecular formula: C<sub>19</sub>H<sub>41</sub>O<sub>3</sub>P

CAS Index Name: Phosphonic acid, methyl-, dinonyl ester

**IUPAC name:** Dinonyl methylphosphonate

Synonyms:

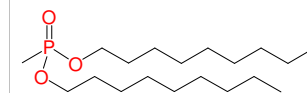

**Chemical name:** Bis(1,3-dimethylbutyl) methylphosphonate

Schedule: 2B04

CAS RN: 959028-09-2

HS code: 2931.39

Key: 959028-09-2

Molecular formula: C<sub>13</sub>H<sub>29</sub>O<sub>3</sub>P

CAS Index Name: Phosphonic acid, methyl-, bis(1,3-dimethylbutyl) ester

**IUPAC name:** Bis(1,3-dimethylbutyl) methylphosphonate

Synonyms: O,O-Bis(1,3-dimethylbutyl) methylphosphonate

Bis(4-methylpentan-2-yl) methylphosphonate

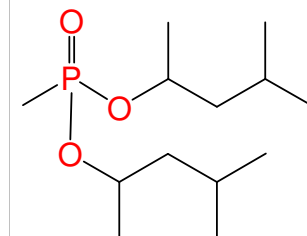

**Chemical name:** Dioctyl propylphosphonate

Schedule: 2B04

CAS RN: 959044-15-6

HS code: 2931.39

Key: 959044-15-6

Molecular formula: C<sub>19</sub>H<sub>41</sub>O<sub>3</sub>P

CAS Index Name: Phosphonic acid, propyl-, dioctyl ester

**IUPAC name:** Dioctyl propylphosphonate

Synonyms: O,O-Dioctyl propylphosphonate

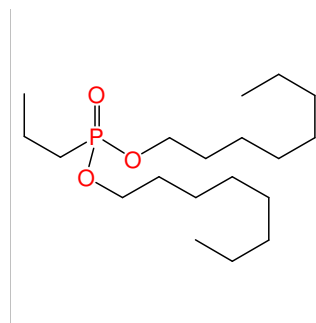

**Chemical name:** Phenyl ethylphosphonofluoridate

Schedule: 2B04

CAS RN: 959259-83-7

HS code: 2931.39

Key: 959259-83-7

Molecular formula: C<sub>8</sub>H<sub>10</sub>FO<sub>2</sub>P

CAS Index Name: Phosphonofluoridic acid, ethyl-, phenyl ester

**IUPAC name:** Phenyl ethylphosphonofluoridoate

Synonyms: O-Phenyl ethylphosphonofluoridate

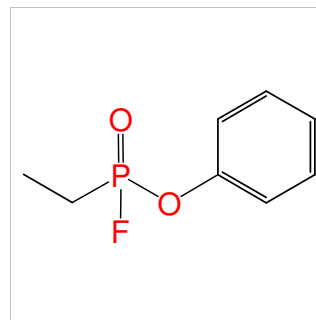

**Chemical name:** Butyl S-dicyclohexylammonium methylphosphonothiolate

Schedule: 2B04

CAS RN: 98283-34-2

HS code: 2930.90

Key: 98283-34-2

Molecular formula: C<sub>17</sub>H<sub>36</sub>NO<sub>2</sub>PS

CAS Index Name: Phosphonothioic acid, methyl-, O-butyl ester, compd. with dicyclohexylamine

**IUPAC name:** S-[Butoxy(methyl)phosphoryl]-N,N-dicyclohexylthiohydroxylammonium

Synonyms: O-Butyl methylphosphonothioic acid, dicyclohexylammonium salt  
NSC 202867

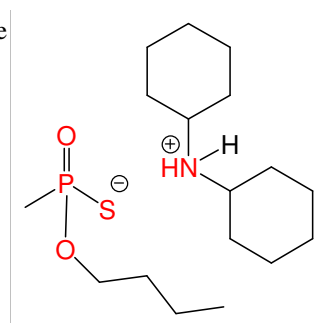

**Chemical name:** Isobutyl S-dicyclohexylammonium methylphosphonothiolate

Schedule: 2B04

CAS RN: 98283-35-3

HS code: 2930.90

Key: 98283-35-3

Molecular formula: C<sub>17</sub>H<sub>36</sub>NO<sub>2</sub>PS

CAS Index Name: Phosphonothioic acid, methyl-, O-isobutyl ester, compd. with dicyclohexylamine

**IUPAC name:** N,N-Dicyclohexyl-S-[isobutoxy(methyl)phosphoryl]thiohydroxylammonium

Synonyms: O-Isobutyl methylphosphonothioic acid, dicyclohexylammonium salt

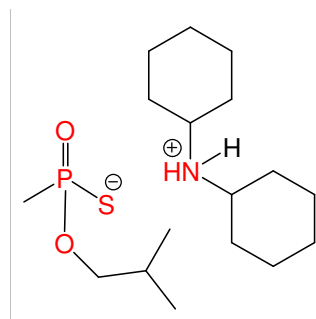

**Chemical name:** Methylphosphonic acid

Schedule: 2B04

CAS RN: 993-13-5

HS code: 2931.39

Key: 993-13-5

Molecular formula: CH<sub>5</sub>O<sub>3</sub>P

CAS Index Name: Phosphonic acid, methyl-

**IUPAC name:** Methylphosphonic acid

Synonyms: Methanephosphonic acid

Dihydrogen methylphosphonate

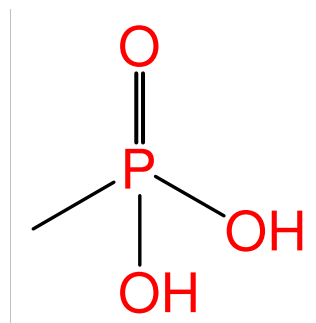

**Chemical name:** Ethylphosphonothioic dichloride

Schedule: 2B04

CAS RN: 993-43-1

HS code: 2931.39

Key: 993-43-1

Molecular formula: C<sub>2</sub>H<sub>5</sub>Cl<sub>2</sub>PS

CAS Index Name: Phosphonothioic dichloride, ethyl-

**IUPAC name:** Ethylphosphonothioic dichloride

Synonyms: Ethylthiophosphonic dichloride

Ethylthiophosphonic acid dichloride

Ethylthionophosphonyl dichloride

Ethyl phosphonothioyl dichloride

Ethanethiophosphonodichloridic acid

Ethanephosphonothionodichloridic acid

Dichloroethylphosphine sulfide

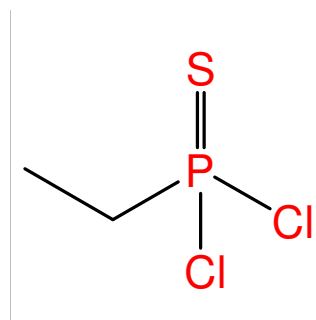

**Chemical name:** Product from the reaction of methylphosphonic acid and 1,2-ethanediamine

Schedule: 2B04

CAS RN: 99580-93-5

HS code:

Key: 99580-93-5

Molecular formula: C<sub>2</sub>H<sub>8</sub>N<sub>2</sub>.CH<sub>5</sub>O<sub>3</sub>P

CAS Index Name: Phosphonic acid, methyl-, compd. with 1,2-ethanediamine (1:1)

**IUPAC name:**

Synonyms: Ethylenediammonium(2+) methylphosphonate

1,2-Ethanediamine, methylphosphonate (1:1)

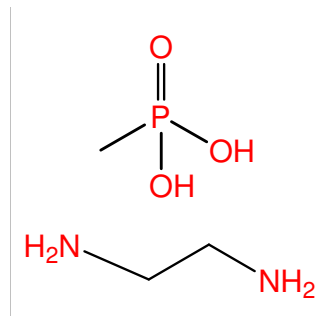

**Chemical name:** S,S-Diethyl methylphosphonodithiolate

Schedule: 2B04

CAS RN: 995-88-0

HS code: 2930.90

Key: 995-88-0

Molecular formula: C<sub>5</sub>H<sub>13</sub>OPS<sub>2</sub>

CAS Index Name: Phosphonodithioic acid, methyl-, S,S-diethyl ester

**IUPAC name:** S,S-Diethyl methylphosphonodithioate

Synonyms: S,S-Diethyl methyldithiophosphate

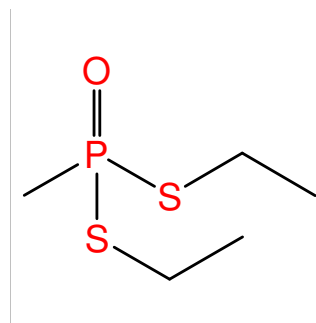

**Chemical name:** Methyl-[14C]-phosphonic dichloride

Schedule: 2B04

CAS RN:

HS code: 2845.90

Key: Cl-M2(14C)2B41-Cl

Molecular formula: C(14C)H<sub>3</sub>Cl<sub>2</sub>OP

CAS Index Name:

**IUPAC name:**

Synonyms:

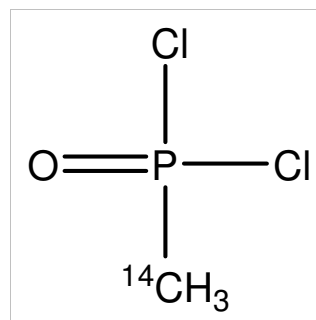

**Chemical name:** Isopropylphosphonothioic acid

Schedule: 2B04

CAS RN:

HS code: 2930.90

Key: I2B45

Molecular formula: C<sub>3</sub>H<sub>9</sub>O<sub>2</sub>PS

CAS Index Name: Phosphonothioic acid, (1-methylethyl)-

**IUPAC name:** Isopropylphosphonothioic O,O-acid

Synonyms: Phosphonothioic acid, 1-methylethyl-

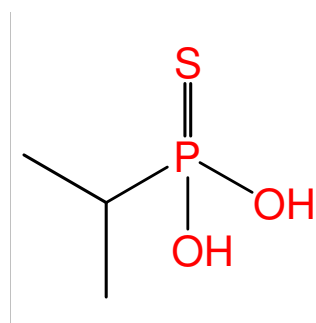

**Chemical name:** [(2R,3S,4R,5R)-5-(6-Amino-9H-purin-9-yl)-3,4-dihydroxytetrahydro-2-furanyl]methyl methylphosphonate

Schedule: 2B04

CAS RN:

HS code: 2931.39

Key: ID1001

Molecular formula: C<sub>11</sub>H<sub>16</sub>N<sub>5</sub>O<sub>6</sub>P

CAS Index Name: Phosphonic acid, methyl-, [(2R,3S,4R,5R)-5-(6-Amino-9H-purin-9-yl)-3,4-dihydroxytetrahydro-2-furanyl]methyl ester

**IUPAC name:** [(2R,3S,4R,5R)-5-(6-Amino-9H-purin-9-yl)-3,4-dihydroxytetrahydrofuran-2-yl]methyl methylphosphonate

Synonyms: [(2R,3S,4R,5R)-5-(6-Amino-9H-purin-9-yl)-3,4-dihydroxytetrahydro-2-furanyl]methyl hydrogen methylphosphonate

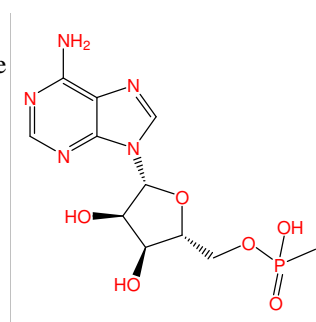

**Chemical name:** Oxyethylated ether of bis(methylphosphonyl) diethylene glycol

Schedule: 2B04

CAS RN:

HS code:

Key: ID1070

Molecular formula:  $C(6+4n)H(16+8n)O(7+2n)P_2$

CAS Index Name:

**IUPAC name:**

Synonyms:

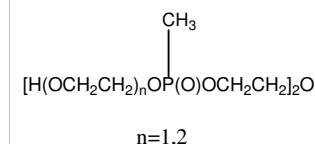

**Chemical name:** Oxymethylated ether of methylphosphonyl pentaerythritol

Schedule: 2B04

CAS RN:

HS code:

Key: ID1071

Molecular formula:  $C_{14}H_{29}O_{11}P$

CAS Index Name:

**IUPAC name:**

Synonyms:

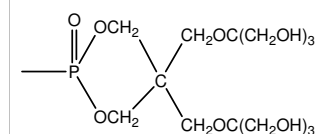

**Chemical name:** Oxyethylated ether of tetra(methylphosphonyl) pentaerythritol

Schedule: 2B04

CAS RN:

HS code:

Key: ID1073

Molecular formula:  $C(9+8n)H(24+16n)O(12+4n)P_4$

CAS Index Name:

**IUPAC name:**

Synonyms:

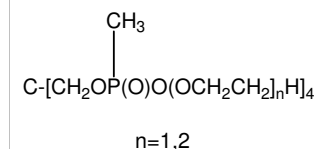

**Chemical name:** 2,2-Dichloro-3,3,3-trifluoro-1-phenylpropyl methylphosphonate

Schedule: 2B04

CAS RN:

HS code: 2931.39

Key: ID1350

Molecular formula:  $C_{10}H_{10}Cl_2F_3O_3P$

CAS Index Name: Phosphonic acid, methyl-, mono(2,2-dichloro-3,3,3-trifluoro-1-phenylpropyl) ester

**IUPAC name:** 2,2-Dichloro-3,3,3-trifluoro-1-phenylpropyl methylphosphonate

Synonyms:

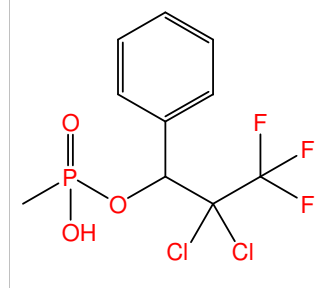

**Chemical name:** 2,2-Difluoro-2-(2,3,3,4,4,5,5-heptafluorotetrahydrofuran-2-yl)-1-phenylethyl methylphosphonate

Schedule: 2B04

CAS RN: HS code: 2931.39

Key: ID1351

Molecular formula: C<sub>13</sub>H<sub>10</sub>F<sub>9</sub>O<sub>4</sub>P

**CAS Index Name:** Methylphosphonic acid, methyl-, mono-[2,2-difluoro-2-(2,3,3,4,4,5,5-heptafluorotetrahydrofuran-2-yl)-1-phenylethyl] ester

**IUPAC name:** 2,2-Difluoro-2-(2,3,3,4,4,5,5-heptafluorotetrahydrofuran-2-yl)-1-phenylethyl methylphosphonate

**Synonyms:** 2,2-Difluoro-2-(perfluorofuran-2-yl)-1-phenylethyl methylphosphonate

2,2-Difluoro-2-(2,3,3,4,4,5,5-heptafluorotetrahydrofuran-2-yl)-1-phenylethyl hydrogen methylphosphonate

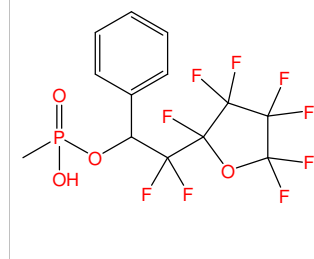

**Chemical name:** 1-(3-Chlorophenyl)-2,2,2-trifluoroethyl methylphosphonate

Schedule: 2B04

CAS RN: HS code: 2931.39

Key: ID1352

Molecular formula: C<sub>9</sub>H<sub>9</sub>ClF<sub>3</sub>O<sub>3</sub>P

**CAS Index Name:** Methylphosphonic acid, methyl-, mono[1-(3-chlorophenyl)-2,2,2-trifluoroethyl] ester

**IUPAC name:** 1-(3-Chlorophenyl)-2,2,2-trifluoroethyl methylphosphonate

**Synonyms:** 1-(3-Chlorophenyl)-2,2,2-trifluoroethyl hydrogen methylphosphonate

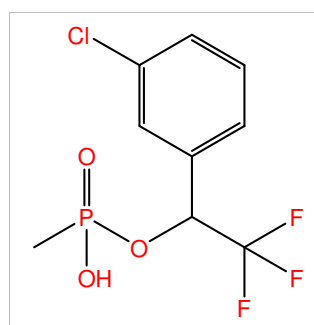

**Chemical name:** 1-(4-Chlorophenyl)-2,2,2-trifluoroethyl methylphosphonate

Schedule: 2B04

CAS RN: HS code: 2931.39

Key: ID1353

Molecular formula: C<sub>9</sub>H<sub>9</sub>ClF<sub>3</sub>O<sub>3</sub>P

**CAS Index Name:** Methylphosphonic acid, methyl-, mono[1-(4-chlorophenyl)-2,2,2-trifluoroethyl] ester

**IUPAC name:** 1-(4-Chlorophenyl)-2,2,2-trifluoroethyl methylphosphonate

**Synonyms:** 1-(4-Chlorophenyl)-2,2,2-trifluoroethyl hydrogen methylphosphonate

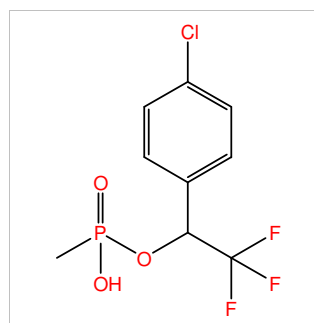

**Chemical name:** 5-Methyl-2,3,7,8-tetrahydro-1,4,6,9,5-benzotetraoxaphosphacycloundecine-5-oxide

Schedule: 2B04

CAS RN: HS code: 2931.39

Key: ID1354

Molecular formula: C<sub>11</sub>H<sub>15</sub>O<sub>5</sub>P

CAS Index Name:

**IUPAC name:** 5-Methyl-2,3,7,8-tetrahydro-1,4,6,9,5-benzotetraoxaphosphacycloundecine-5-oxide

Synonyms: 9-Methyl-6,7,11,12-tetrahydro-5,8,10,13-tetraoxa-9-phosphabenzocycloundecine-9-oxide

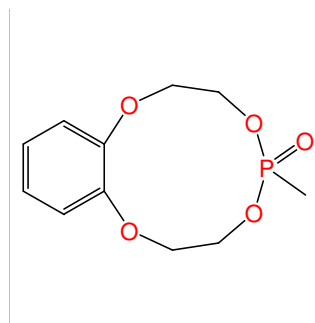

**Chemical name:** [2,2,2-trifluoro-1-(3-methoxyphenyl)]ethyl methylphosphonate

Schedule: 2B04

CAS RN: HS code: 2931.39

Key: ID1363

Molecular formula: C<sub>10</sub>H<sub>12</sub>F<sub>3</sub>O<sub>4</sub>P

CAS Index Name: Phosphonic acid, methyl-, mono[2,2,2-trifluoro-1-(3-methoxyphenyl)]ethyl ester

**IUPAC name:** 2,2,2-trifluoro-1-(3-methoxyphenyl)ethyl hydrogen methylphosphonate

Synonyms: Methylphosphonic acid mono[2,2,2-trifluoro-1-(3-methoxyphenyl)ethyl]ester

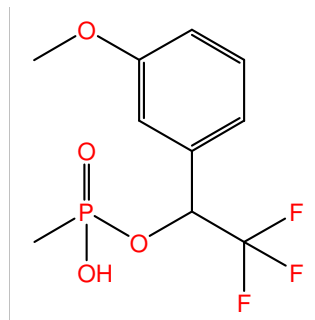

**Chemical name:** Methyl-bis[2-butoxy(methyl)phosphoryloxyethyl]amine

Schedule: 2B04

CAS RN: HS code: 2931.39

Key: ID4225

Molecular formula: C<sub>15</sub>H<sub>35</sub>NO<sub>6</sub>P<sub>2</sub>

CAS Index Name:

**IUPAC name:**

Synonyms:

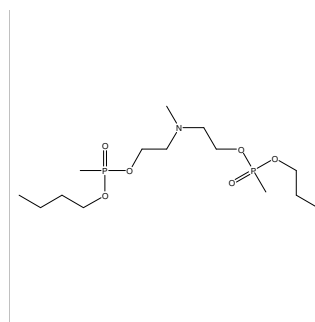

**Chemical name:** 1-Cyclohexyl-2-methoxyethyl ethylphosphonate

Schedule: 2B04

CAS RN: HS code: 2931.39

Key: ID998

Molecular formula: C<sub>11</sub>H<sub>23</sub>O<sub>4</sub>P

CAS Index Name: Phosphonic acid, ethyl-, monocyclohexyl(2-methoxyethyl) ester

**IUPAC name:** 1-Cyclohexyl-2-methoxyethyl ethylphosphonate

Synonyms:

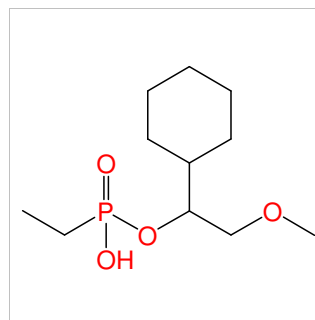



**Chemical name:** Disodium methylphosphonate

Schedule: 2B04

CAS RN: HS code: 2931.39

Key: M2B41-O(Na)-O(Na)

Molecular formula: CH<sub>3</sub>Na<sub>2</sub>O<sub>3</sub>P

CAS Index Name: Phosphonic acid, methyl-, disodium salt

**IUPAC name:** Disodium methylphosphonate

Synonyms:

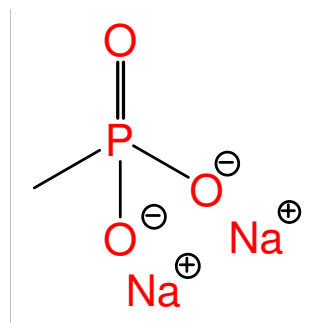

**Chemical name:** O,O-Bis(1-butylpentyl) methylphosphonothionate

Schedule: 2B04

CAS RN: HS code: 2930.90

Key: M2B45-O(623-93-8)

Molecular formula: C<sub>19</sub>H<sub>41</sub>O<sub>2</sub>PS

CAS Index Name: Phosphonothioic acid, methyl-, O,O-bis(1-butylpentyl) ester

**IUPAC name:** O,O-Bis(1-butylpentyl) methylphosphonothioate

Synonyms: O,O-Bis(nonan-5-yl) methylphosphonothionate

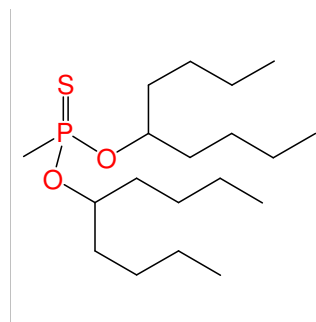

**Chemical name:** S-Methyl methylphosphonochloridothioate-d<sub>3</sub>

Schedule: 2B04

CAS RN: HS code: 2845.90

Key: S(67-56-1)-M(d<sub>3</sub>)2B41-Cl

Molecular formula: C<sub>2</sub>H<sub>3</sub>D<sub>3</sub>ClOPS

CAS Index Name:

**IUPAC name:**

Synonyms:

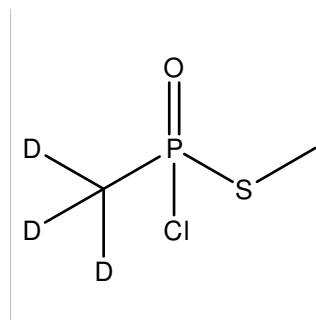

**Chemical name:** S-Methyl methylphosphonoamidothiolate

Schedule: 2B04

CAS RN: HS code: 2930.90

Key: S(67-56-1)-M2B42-NH<sub>2</sub>

Molecular formula: C<sub>2</sub>H<sub>8</sub>NOPS

CAS Index Name:

**IUPAC name:**

Synonyms:

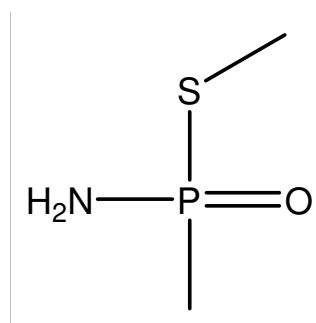

**Chemical name:** S-Isobutyl ethylphosphinothioate

Schedule: 2B04

CAS RN: HS code: 2930.90

Key: S(78-83-1)-E2B42

Molecular formula: C<sub>6</sub>H<sub>15</sub>OPS

CAS Index Name:

**IUPAC name:**

Synonyms:

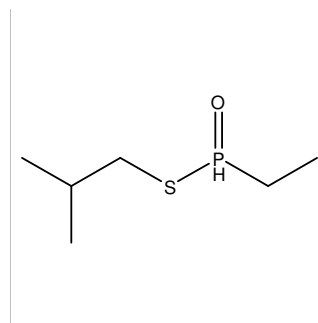

**Chemical name:** S-2-Diethylaminoethyl methylphosphonothionofluoridate

Schedule: 2B04

CAS RN: HS code: 2930.90

Key: S[N(64-17-5)(64-17-5)]-M2B41-F

Molecular formula: C<sub>7</sub>H<sub>17</sub>FNOPS

CAS Index Name: Phosphonofluoridothioic acid, methyl-, S-[2-(diethylamino)ethyl] ester

**IUPAC name:** S-2-Diethylaminoethyl methylphosphonothionofluoridate

Synonyms: S-2-Diethylaminoethyl methylphosphonofluoridothioate

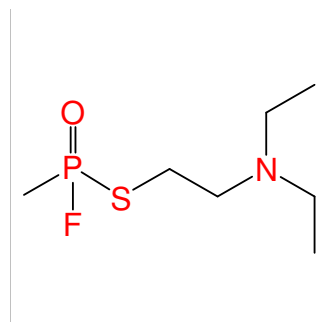

**Chemical name:** S-2-Diisopropylaminoethyl methylphosphonothionofluoridate

Schedule: 2B04

CAS RN: HS code: 2930.90

Key: S[N(67-63-0)(67-63-0)]-M2B41-F

Molecular formula: C<sub>9</sub>H<sub>21</sub>FNO<sub>2</sub>PS

CAS Index Name: Phosphonofluoridothioic acid, methyl-, S-[2-(bis(1-methylethyl)amino)ethyl] ester

**IUPAC name:** S-2-Diisopropylaminoethyl methylphosphonothionofluoridate

Synonyms: S-2-(Diisopropylamino)ethyl methylphosphonofluoridothioate

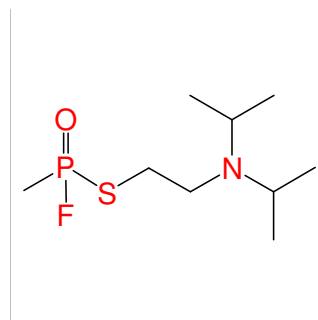

**Chemical name:** N,N-Diethylphosphoramidic dichloride

Schedule: 2B05

CAS RN: 1498-54-0

HS code: 2929.90

Key: 1498-54-0

Molecular formula: C<sub>4</sub>H<sub>10</sub>Cl<sub>2</sub>NOP

CAS Index Name: Phosphoramidic dichloride, diethyl-

**IUPAC name:** Diethylphosphoramidic dichloride

Synonyms: P,P-Dichloro-N,N-diethylphosphinic amide

Diethylphosphoramidoyl dichloride

Dichlorodiethylphosphoramidite

Dichloro(diethylamino)phosphine oxide

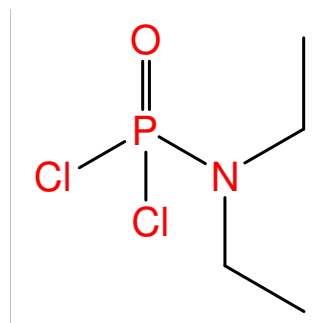

**Chemical name:** N,N-Diisopropylphosphoramidic dichloride

Schedule: 2B05

CAS RN: 23306-80-1

HS code: 2929.90

Key: 23306-80-1

Molecular formula: C<sub>6</sub>H<sub>14</sub>Cl<sub>2</sub>NOP

CAS Index Name: Phosphoramidic dichloride, bis(1-methylethyl)-

**IUPAC name:** Diisopropylphosphoramidic dichloride

Synonyms: Phosphoramidic dichloride, diisopropyl-

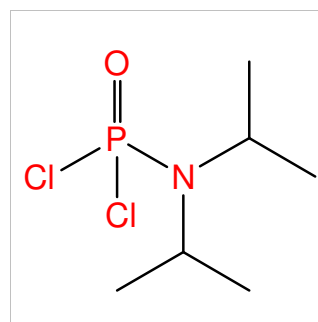

**Chemical name:** N,N-Dipropylphosphoramidic dichloride

Schedule: 2B05

CAS RN: 40881-98-9

HS code: 2929.90

Key: 40881-98-9

Molecular formula: C<sub>6</sub>H<sub>14</sub>Cl<sub>2</sub>NOP

CAS Index Name: Phosphoramidic dichloride, dipropyl-

**IUPAC name:** Dipropylphosphoramidic dichloride

Synonyms: Dipropylphosphoramidoyl dichloride

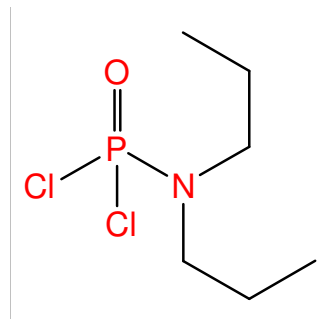

**Chemical name:** N,N-Dimethylphosphoramidic dichloride

Schedule: 2B05

CAS RN: 677-43-0

HS code: 2929.90

Key: 677-43-0

Molecular formula: C<sub>2</sub>H<sub>6</sub>Cl<sub>2</sub>NOP

CAS Index Name: Phosphoramidic dichloride, dimethyl-

**IUPAC name:** Dimethylphosphoramidic dichloride

Synonyms: Dimethylphosphorodichloridic amide  
Dimethylamidophosphoric acid dichloride  
Dichlorophosphoric dimethylamide  
Dichloro(dimethylamino)phosphine oxide  
(Dimethylamido)phosphoric dichloride

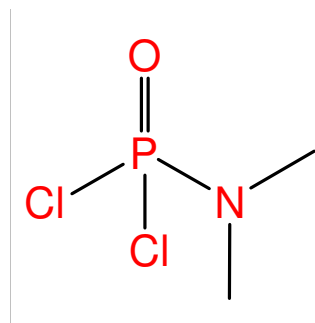

**Chemical name:** N-Ethyl-N-methylphosphoramidic dichloride

Schedule: 2B05

CAS RN: 777943-34-7

HS code: 2929.90

Key: 777943-34-7

Molecular formula: C<sub>3</sub>H<sub>8</sub>Cl<sub>2</sub>NOP

CAS Index Name: Phosphoramidic dichloride, ethylmethyl-

**IUPAC name:** Ethylmethylphosphoramidic dichloride

Synonyms:

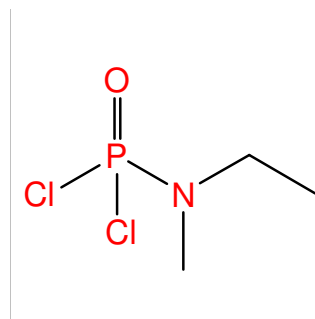

**Chemical name:** N-Methyl-N-propylphosphoramidic dichloride

Schedule: 2B05

CAS RN: 777943-35-8

HS code: 2929.90

Key: 777943-35-8

Molecular formula: C<sub>4</sub>H<sub>10</sub>Cl<sub>2</sub>NOP

CAS Index Name: Phosphoramidic dichloride, methylpropyl-

**IUPAC name:** Methylpropylphosphoramidic dichloride

Synonyms:

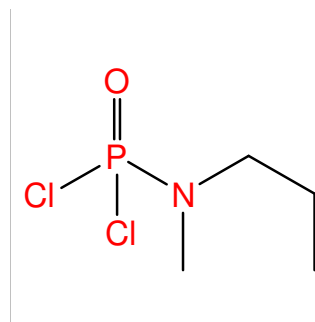

**Chemical name:** N-Isopropyl-N-methylphosphoramidic dichloride

Schedule: 2B05

CAS RN: 777943-36-9

HS code: 2929.90

Key: 777943-36-9

Molecular formula: C<sub>4</sub>H<sub>10</sub>Cl<sub>2</sub>NOP

CAS Index Name: Phosphoramidic dichloride, methyl(1-methylethyl)-

**IUPAC name:** Isopropylmethylphosphoramidic dichloride

Synonyms: methyl(propan-2-yl)phosphoramidic dichloride

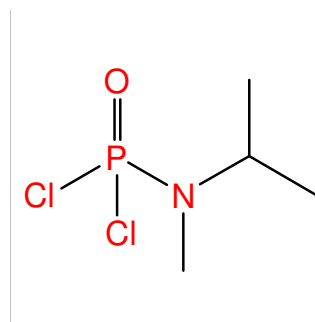

**Chemical name:** N-Ethyl-N-isopropylphosphoramidic dichloride

Schedule: 2B05

CAS RN: 777943-37-0

HS code: 2929.90

Key: 777943-37-0

Molecular formula: C<sub>5</sub>H<sub>12</sub>Cl<sub>2</sub>NOP

CAS Index Name: Phosphoramidic dichloride, ethyl(1-methylethyl)-

**IUPAC name:** Ethylisopropylphosphoramidic dichloride

Synonyms:

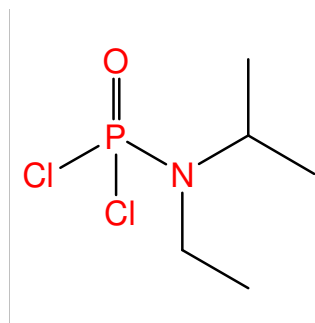

**Chemical name:** N-Ethyl-N-propylphosphoramidic dichloride

Schedule: 2B05

CAS RN: 777943-38-1

HS code: 2929.90

Key: 777943-38-1

Molecular formula: C<sub>5</sub>H<sub>12</sub>Cl<sub>2</sub>NOP

CAS Index Name: Phosphoramidic dichloride, ethylpropyl-

**IUPAC name:** Ethylpropylphosphoramidic dichloride

Synonyms:

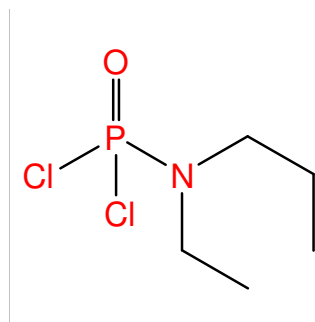

**Chemical name:** Dimethyl(d<sub>3</sub>) N,N-dimethyl(d<sub>3</sub>)phosphoramidate

Schedule: 2B06

CAS RN: 1174023-68-7

HS code: 2845.90

Key: 1174023-68-7

Molecular formula: C<sub>4</sub>D<sub>12</sub>NO<sub>3</sub>P

CAS Index Name: Phosphoramidic acid, N,N-di(methyl-d<sub>3</sub>)-, di(methyl-d<sub>3</sub>) ester

**IUPAC name:**

Synonyms:

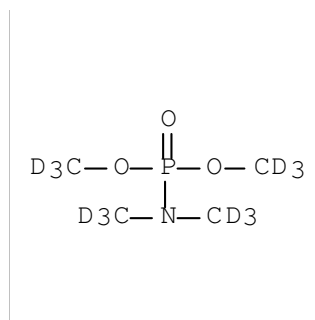

**Chemical name:** Dimethyl N,N-diisopropylphosphoramidate

Schedule: 2B06

CAS RN: 170275-46-4

HS code: 2929.90

Key: 170275-46-4

Molecular formula: C<sub>8</sub>H<sub>20</sub>NO<sub>3</sub>P

CAS Index Name: Phosphoramidic acid, bis(1-methylethyl)-, dimethyl ester

**IUPAC name:** Dimethyl diisopropylphosphoramidoate

Synonyms: O,O-Dimethyl N,N-diisopropylphosphoramidate

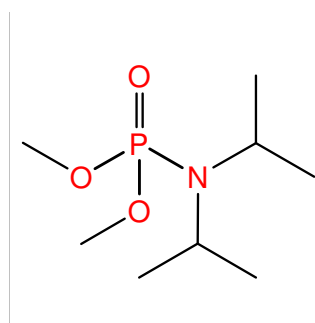

**Chemical name:** Dipropyl N,N-dipropylphosphoramidate

Schedule: 2B06

CAS RN: 17123-10-3

HS code: 2929.90

Key: 17123-10-3

Molecular formula: C<sub>12</sub>H<sub>28</sub>NO<sub>3</sub>P

CAS Index Name: Phosphoramidic acid, dipropyl-, dipropyl ester

**IUPAC name:** Dipropyl dipropylphosphoramidoate

Synonyms: O,O-Dipropyl N,N-dipropylphosphoramidate

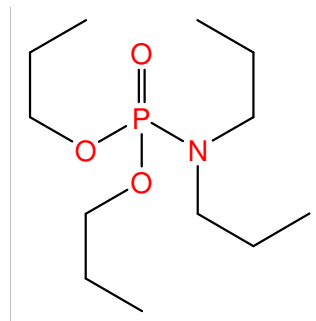

**Chemical name:** Dipropyl N,N-diethylphosphoramidate

Schedule: 2B06

CAS RN: 22250-42-6

HS code: 2929.90

Key: 22250-42-6

Molecular formula: C<sub>10</sub>H<sub>24</sub>NO<sub>3</sub>P

CAS Index Name: Phosphoramidic acid, diethyl-, dipropyl ester

**IUPAC name:** Dipropyl diethylphosphoramidoate

Synonyms: O,O-Dipropyl N,N-diethylphosphoramidate

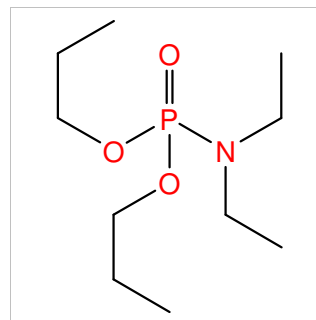

**Chemical name:** Diethyl N,N-dimethylphosphoramidate

Schedule: 2B06

CAS RN: 2404-03-7

HS code: 2929.90

Key: 2404-03-7

Molecular formula: C<sub>6</sub>H<sub>16</sub>NO<sub>3</sub>P

CAS Index Name: Phosphoramidic acid, dimethyl-, diethyl ester

**IUPAC name:** Diethyl dimethylphosphoramidoate

Synonyms: O-O-Diethyl N,N-dimethylphosphoramidate  
N,N-Dimethyl-O-O'-diethylphosphoramidate  
Diethyl N,N-dimethylphosphoramidate  
Diethyl dimethylphosphoramidate  
(Dimethylamino)diethoxyphosphine oxide

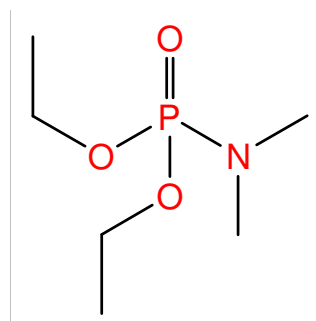

**Chemical name:** Diisopropyl N,N-dimethylphosphoramidate

Schedule: 2B06

CAS RN: 2404-04-8

HS code: 2929.90

Key: 2404-04-8

Molecular formula: C<sub>8</sub>H<sub>20</sub>NO<sub>3</sub>P

CAS Index Name: Phosphoramidic acid, dimethyl-, bis(1-methylethyl) ester

**IUPAC name:** Diisopropyl dimethylphosphoramidoate

Synonyms: O,O-Diisopropyl N,N-dimethylphosphoramidate

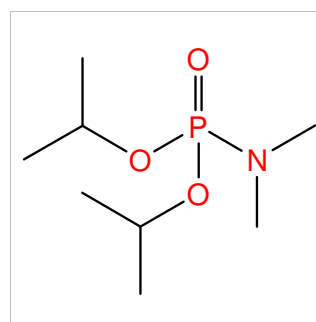

**Chemical name:** Diethyl N,N-diethylphosphoramidate

Schedule: 2B06

CAS RN: 3167-69-9

HS code: 2929.90

Key: 3167-69-9

Molecular formula: C<sub>8</sub>H<sub>20</sub>NO<sub>3</sub>P

CAS Index Name: Phosphoramidic acid, diethyl-, diethyl ester

**IUPAC name:** Diethyl diethylphosphoramidoate

Synonyms: O,O-Diethyl N,N-diethylphosphoramidate

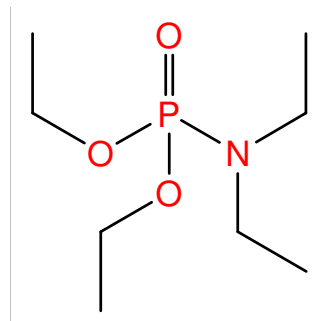

**Chemical name:** Diethyl ethyl(methyl)phosphoramidate

Schedule: 2B06

CAS RN: 53279-98-4

HS code: 2929.90

Key: 53279-98-4

Molecular formula: C<sub>7</sub>H<sub>18</sub>NO<sub>3</sub>P

CAS Index Name: Phosphoramidic acid, N-ethyl-N-methyl-, diethyl ester

**IUPAC name:** Diethyl ethyl(methyl)phosphoramidoate

Synonyms: Phosphoramidic acid, ethylmethyl-, diethyl ester

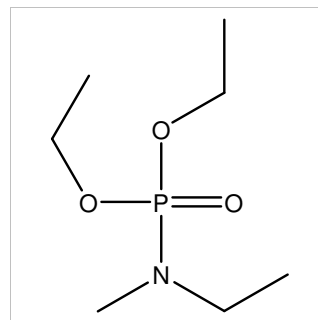

**Chemical name:** Dimethyl N,N-dimethylphosphoramidate

Schedule: 2B06

CAS RN: 597-07-9

HS code: 2929.90

Key: 597-07-9

Molecular formula: C<sub>4</sub>H<sub>12</sub>NO<sub>3</sub>P

CAS Index Name: Phosphoramidic acid, dimethyl-, dimethyl ester

**IUPAC name:** Dimethyl dimethylphosphoramidoate

Synonyms: O,O-Dimethyl N,N-dimethylphosphoramidate

Dimethyl dimethylphosphoramidate

Dimethyl (dimethylamido)phosphate

Dimethoxy(dimethylamino)phosphine oxide

1715 HC

(Dimethylamino)dimethoxyphosphine oxide

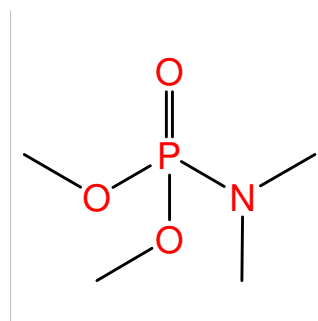

**Chemical name:** Dimethyl N,N-diethylphosphoramidate

Schedule: 2B06

CAS RN: 65659-19-0

HS code: 2929.90

Key: 65659-19-0

Molecular formula: C<sub>6</sub>H<sub>16</sub>NO<sub>3</sub>P

CAS Index Name: Phosphoramidic acid, diethyl-, dimethyl ester

**IUPAC name:** Dimethyl diethylphosphoramidoate

Synonyms: O,O-Dimethyl N,N-diethylphosphoramidate

NSC 244347

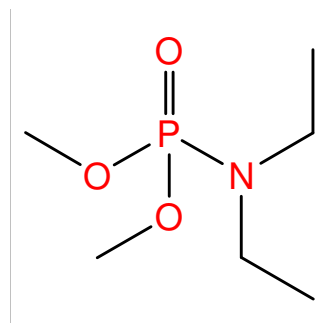

**Chemical name:** Ethyl methyl N,N-diisopropylphosphoramidate

Schedule: 2B06

CAS RN: 848216-15-9

HS code: 2929.90

Key: 848216-15-9

Molecular formula: C<sub>9</sub>H<sub>22</sub>NO<sub>3</sub>P

CAS Index Name: Phosphoramidic acid, bis(1-methylethyl)-, ethyl methyl ester

**IUPAC name:** Ethyl methyl dipropan-2-ylphosphoramidoate

Synonyms: O-Ethyl O-methyl N,N-diisopropylphosphoramidate

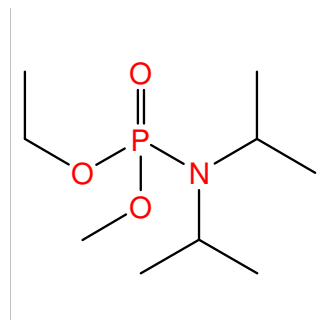

**Chemical name:** Ethyl methyl ethylisopropylphosphoramidate

Schedule: 2B06

CAS RN: 906801-34-1

HS code: 2929.90

Key: 906801-34-1

Molecular formula: C<sub>8</sub>H<sub>20</sub>NO<sub>3</sub>P

CAS Index Name: Phosphoramidic acid, ethyl(1-methylethyl)-, ethyl methyl ester

**IUPAC name:** Ethyl methyl ethyl(propan-2-yl)phosphoramidoate

Synonyms: O-Ethyl O-methyl N-ethyl-N-isopropylphosphoramidate

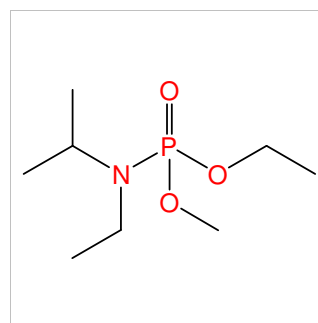

**Chemical name:** Diethyl N,N-dipropylphosphoramidate

Schedule: 2B06

CAS RN: 91043-34-4

HS code: 2929.90

Key: 91043-34-4

Molecular formula: C<sub>10</sub>H<sub>24</sub>NO<sub>3</sub>P

CAS Index Name: Phosphoramidic acid, dipropyl-, diethyl ester

**IUPAC name:** Diethyl dipropylphosphoramidoate

Synonyms: O,O-Diethyl N,N-dipropylphosphoramidate

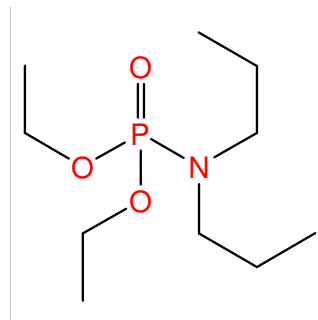



**Chemical name:** Dipropyl N,N-dimethylphosphoramidate

Schedule: 2B06

CAS RN: 98543-28-3

HS code: 2929.90

Key: 98543-28-3

Molecular formula: C<sub>8</sub>H<sub>20</sub>NO<sub>3</sub>P

CAS Index Name: Phosphoramidic acid, dimethyl-, dipropyl ester

**IUPAC name:** Dipropyl dimethylphosphoramidoate

Synonyms: O,O-Dipropyl N,N-dimethylphosphoramidate

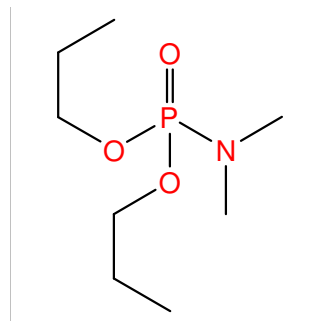

**Chemical name:** Arsenic trichloride

Schedule: 2B07

CAS RN: 7784-34-1

HS code: 2812.19

Key: 7784-34-1

Molecular formula: AsCl<sub>3</sub>

CAS Index Name: Arsenous trichloride

**IUPAC name:** Arsenic trichloride

Synonyms: Trichloroarsine

Fuming liquid arsenic

Arsenous chloride

Arsenic(III) chloride

Arsenic(3+) chloride

Arsenic chloride (AsCl<sub>3</sub>)

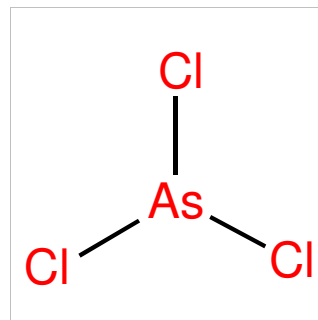

**Chemical name:** 2,2-Diphenyl-2-hydroxyacetic acid

Schedule: 2B08

CAS RN: 76-93-7

HS code: 2918.17

Key: 76-93-7

Molecular formula: C<sub>14</sub>H<sub>12</sub>O<sub>3</sub>

CAS Index Name: Benzeneacetic acid,  $\alpha$ -hydroxy- $\alpha$ -phenyl-

**IUPAC name:** 2,2-Diphenyl-2-hydroxyacetic acid

Synonyms: NSC 2830

Hydroxydiphenylacetic acid

Hydroxy(diphenyl)acetic acid

Diphenylhydroxyacetic acid

Diphenylglycolic acid

Benzilic acid

$\alpha$ -Hydroxydiphenylacetic acid

$\alpha$ -Hydroxy- $\alpha$ -phenylbenzeneacetic acid

$\alpha$ -Hydroxy-2,2-diphenylacetic acid

$\alpha,\alpha$ -Diphenylglycolic acid

$\alpha,\alpha$ -Diphenyl- $\alpha$ -hydroxyacetic acid

2-Hydroxy-2,2-diphenylacetic acid

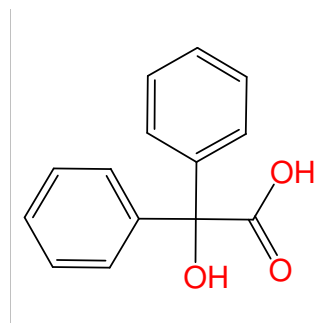

**Chemical name:** 3-Quinuclidinol

Schedule: 2B09

CAS RN: 1619-34-7

HS code: 2933.39

Key: 1619-34-7

Molecular formula: C<sub>7</sub>H<sub>13</sub>NO

CAS Index Name: 1-Azabicyclo[2.2.2]octan-3-ol

**IUPAC name:** 1-Azabicyclo[2.2.2]octan-3-ol

Synonyms: Quinuclidin-3-ol

NSC-93905

DL-3-Quinuclidinol

3-Hydroxyquinuclidine

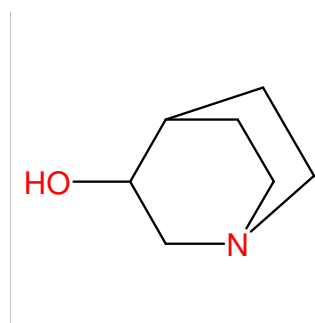

**Chemical name:** R-(-)-3-Quinuclidinol

Schedule: 2B09

CAS RN: 25333-42-0

HS code: 2933.39

Key: 25333-42-0

Molecular formula: C<sub>7</sub>H<sub>13</sub>NO

CAS Index Name: 1-Azabicyclo[2.2.2]octan-3-ol, (3R)-

**IUPAC name:** (3R)-1-Azabicyclo[2.2.2]octan-3-ol

Synonyms: (R)-3-Quinuclidinol  
(R)-3-Hydroxyquinuclidine  
(R)-1-Azabicyclo[2.2.2]octan-3-ol  
(R)-(-)-3-Quinuclidinol  
(R)-(-)-1-Azabicyclo[2.2.2]octan-3-ol  
(3R)-Quinuclidin-3-ol  
(3R)-3-Quinuclidol  
(3R)-3-Quinuclidinol

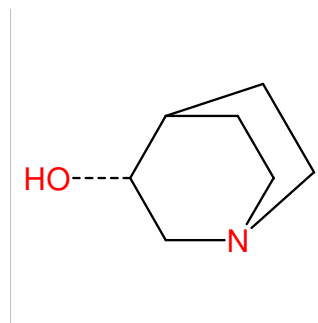

**Chemical name:** S-(+)-3-Quinuclidinol

Schedule: 2B09

CAS RN: 34583-34-1

HS code: 2933.39

Key: 34583-34-1

Molecular formula: C<sub>7</sub>H<sub>13</sub>NO

CAS Index Name: 1-Azabicyclo[2.2.2]octan-3-ol, (3S)-

**IUPAC name:** (3S)-1-Azabicyclo[2.2.2]octan-3-ol

Synonyms: 1-Azabicyclo[2.2.2]octan-3-ol, (S)-  
(S)-3-Quinuclidinol  
(S)-3-Hydroxyquinuclidine  
(S)-1-Azabicyclo[2.2.2]octan-3-ol  
(S)-(+)-1-Azabicyclo[2.2.2]octane-3-ol  
(S)-(+)-1-Azabicyclo[2.2.2]octan-3-ol  
(3S)-Quinuclidin-3-ol  
(3S)-(+)-3-Quinuclidinol

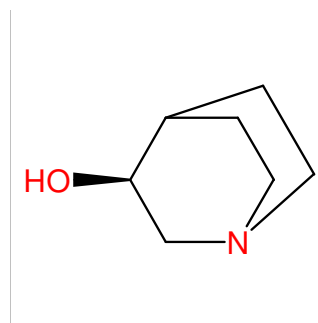

**Chemical name:** 2-(N,N-Diethylamino)ethylchloride

Schedule: 2B10

CAS RN: 100-35-6

HS code: 2921.19

Key: 100-35-6

Molecular formula: C<sub>6</sub>H<sub>14</sub>ClN

CAS Index Name: Ethanamine, 2-chloro-N,N-diethyl-

**IUPAC name:** 2-Chloro-N,N-diethylethanamine

Synonyms: Diethyl(2-chloroethyl)amine  
(β-Chloroethyl)diethylamine  
1-Diethylamino-2-chloroethane  
2-(Diethylamino)-1-chloroethane  
2-(Diethylamino)chloroethane  
2-(Diethylamino)ethyl chloride  
2-(N,N-Diethylamino)ethyl chloride  
2-Chloroethyl-N,N-diethylamine  
(2-Chloroethyl)diethylamine  
2-N,N-Diethylaminoethyl chloride  
Triethylamine, 2-chloro-  
Diethylaminoethyl chloride  
N,N-Diethyl-2-chloroethylamine  
N,N-Diethylaminoethyl chloride  
N,N-Diethylaminoethyl-2-chloride  
N-(2-chloroethyl)-N,N-diethylamine  
N-(2-Chloroethyl)diethylamine  
β-(Diethylamino)ethyl chloride  
β-Chlorotriethylamine  
2-Chlorotriethylamine

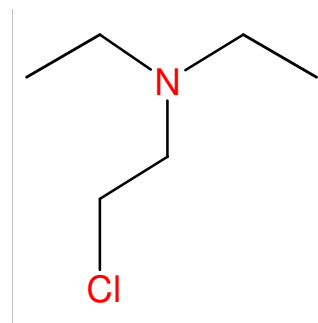

**Chemical name:** 2-(N,N-Dimethylamino)ethylchloride

Schedule: 2B10

CAS RN: 107-99-3

HS code: 2921.19

Key: 107-99-3

Molecular formula: C<sub>4</sub>H<sub>10</sub>ClN

CAS Index Name: Ethanamine, 2-chloro-N,N-dimethyl-

**IUPAC name:** 2-Chloro-N,N-dimethylethanamine

Synonyms: N,N-Dimethyl-2-chloroethylamine

1-Chloro-2-(dimethylamino)ethane

1-Dimethylamino-2-chloroethane

2-(Dimethylamino)-1-chloroethane

2-(Dimethylamino)ethyl chloride

2-Chloro-1-(dimethylamino)ethane

2-Chloro-N,N-dimethylethylamine

Chloro(dimethylamino)ethane

Dimethyl(2-chloroethyl)amine

(2-Chloroethyl)dimethylamine

Ethylamine, 2-chloro-N,N-dimethyl-

β-Chloroethyldimethylamine

N,N-Dimethyl-beta-chloroethylamine

N,N-Dimethyl-N-(2-chloroethyl)amine

N,N-Dimethylaminoethyl-2-chloride

N-(2-chloroethyl)-N,N-dimethylamine

N-(2-Chloroethyl)dimethylamine

NSC 1917

β-(Dimethylamino)ethylchloride

β-(N,N-Dimethylamino)ethylchloride

Dimethylaminoethylchloride

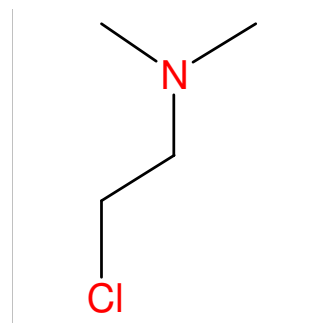

**Chemical name:** 2-(N,N-Diethyl(d10)amino)ethylchloride hydrochloride

Schedule: 2B10

CAS RN: 1092978-87-4

HS code: 2845.90

Key: 1092978-87-4

Molecular formula: C<sub>6</sub>H<sub>4</sub>ClD<sub>10</sub>N · ClH

CAS Index Name: Ethan-1,1,2,2,2-d<sub>5</sub>-amine, N-(2-chloroethyl)-N-(ethyl-1,1,2,2,2-d<sub>5</sub>-), hydrochloride (1:1)

**IUPAC name:**

Synonyms:

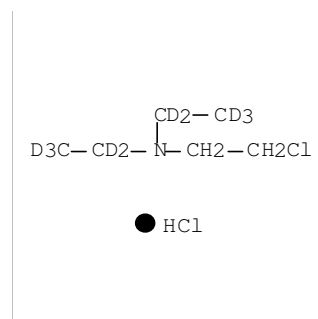

**Chemical name:** 2-(N-methyl-N-ethyl(d5)amino)ethylchloride hydrochloride

Schedule: 2B10

CAS RN: 1092978-90-9

HS code: 2845.90

Key: 1092978-90-9

Molecular formula: C<sub>5</sub>H<sub>7</sub>ClD<sub>5</sub>N . ClH

CAS Index Name: Ethan-1,1,2,2,2-d<sub>5</sub>-amine, N-(2-chloroethyl)-N-methyl-, hydrochloride (1:1)

**IUPAC name:**

Synonyms:

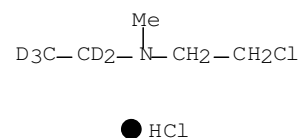

**Chemical name:** 2-(N,N-propyl(d7)propylamino)ethylchloride hydrochloride

Schedule: 2B10

CAS RN: 1092978-92-1

HS code: 2845.90

Key: 1092978-92-1

Molecular formula: C<sub>8</sub>H<sub>11</sub>ClD<sub>7</sub>N . ClH

CAS Index Name: 1-Propan-1,1,2,2,3,3,3-d<sub>7</sub>-amine, N-(2-chloroethyl)-N-propyl-, hydrochloride (1:1)

**IUPAC name:**

Synonyms:

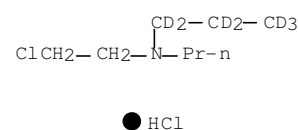

**Chemical name:** 2-(N,N-Diethyl(d10)amino)ethylchloride

Schedule: 2B10

CAS RN: 1093059-99-4

HS code: 2845.90

Key: 1093059-99-4

Molecular formula: C<sub>6</sub>H<sub>4</sub>ClD<sub>10</sub>N

CAS Index Name: Ethan-1,1,2,2,2-d<sub>5</sub>-amine, N-(2-chloroethyl)-N-(ethyl-1,1,2,2,2-d<sub>5</sub>)-

**IUPAC name:**

Synonyms:

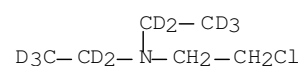

**Chemical name:** 2-(N-Methyl-N-ethyl(d5)amino)ethylchloride

Schedule: 2B10

CAS RN: 1093060-00-4

HS code: 2845.90

Key: 1093060-00-4

Molecular formula: C<sub>5</sub>H<sub>7</sub>ClD<sub>5</sub>N

CAS Index Name: Ethan-1,1,2,2,2-d<sub>5</sub>-amine, N-(2-chloroethyl)-N-methyl-

**IUPAC name:**

Synonyms:

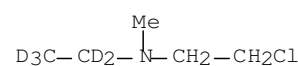

**Chemical name:** 2-(N-Propyl(d7)-N-propylamino)ethylchloride

Schedule: 2B10

CAS RN: 1093060-01-5

HS code: 2845.90

Key: 1093060-01-5

Molecular formula: C<sub>8</sub>H<sub>11</sub>ClD<sub>7</sub>N

CAS Index Name: 1-Propan-1,1,2,2,3,3,3-d7-amine, N-(2-chloroethyl)-N-propyl-

**IUPAC name:**

Synonyms:

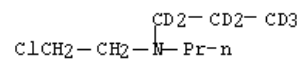

**Chemical name:** 2-(N,N-Dimethyl(C13)amino)ethylchloride

Schedule: 2B10

CAS RN: 1148114-15-1

HS code: 2845.90

Key: 1148114-15-1

Molecular formula: C<sub>4</sub>H<sub>10</sub>ClN

CAS Index Name: Ethanamine, 2-chloro-N,N-di(methyl-13C)-

**IUPAC name:**

Synonyms:

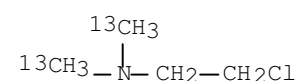

**Chemical name:** 2-(N,N-Diethylamino)ethyl(d4)chloride hydrochloride

Schedule: 2B10

CAS RN: 1219805-94-3

HS code: 2845.90

Key: 1219805-94-3

Molecular formula: C<sub>6</sub>H<sub>10</sub>ClD<sub>4</sub>N . ClH

CAS Index Name: Ethan-1,1,2,2-d4-amine, 2-chloro-N,N-diethyl-, hydrochloride (1:1)

**IUPAC name:**

Synonyms:

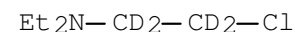

**Chemical name:** 2-(N,N-Diethylamino)ethyl(d4)chloride

Schedule: 2B10

CAS RN: 1219908-93-6

HS code: 2845.90

Key: 1219908-93-6

Molecular formula: C<sub>6</sub>H<sub>10</sub>ClD<sub>4</sub>N

CAS Index Name: Ethan-1,1,2,2-d4-amine, 2-chloro-N,N-diethyl-

**IUPAC name:**

Synonyms:



**Chemical name:** 2-(N,N-Dimethylamino)ethyl(d4)chloride hydrochloride

Schedule: 2B10

CAS RN: 1252995-12-2

HS code: 2845.90

Key: 1252995-12-2

Molecular formula: C<sub>4</sub>H<sub>6</sub>ClD<sub>4</sub>N . ClH

CAS Index Name: Ethan-1,1,2,2-d<sub>4</sub>-amine, 2-chloro-N,N-dimethyl-, hydrochloride (1:1)

**IUPAC name:**

Synonyms:

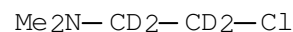

**Chemical name:** 2-(N,N-Dimethyl(d6)amino)ethyl(d4)chloride hydrochloride

Schedule: 2B10

CAS RN: 1252995-13-3

HS code: 2845.90

Key: 1252995-13-3

Molecular formula: C<sub>4</sub>ClD<sub>10</sub>N . ClH

CAS Index Name: Ethan-1,1,2,2-d<sub>4</sub>-amine, 2-chloro-N,N-di(methyl-d<sub>3</sub>)-, hydrochloride (1:1)

**IUPAC name:**

Synonyms:

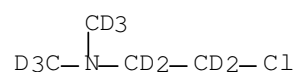

**Chemical name:** 2-(N,N-Dimethyl(d6)amino)ethyl(d4)chloride

Schedule: 2B10

CAS RN: 1253176-81-6

HS code: 2845.90

Key: 1253176-81-6

Molecular formula: C<sub>4</sub>ClD<sub>10</sub>N

CAS Index Name: Ethan-1,1,2,2-d<sub>4</sub>-amine, 2-chloro-N,N-di(methyl-d<sub>3</sub>)-

**IUPAC name:**

Synonyms:

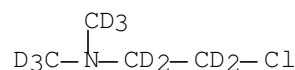

**Chemical name:** 2-(N,N-Diethylamino)ethylchloride and Tetrafluoroborate(H<sup>+</sup>) (1:1)

Schedule: 2B10

CAS RN: 1255381-66-8

HS code: 2921.19

Key: 1255381-66-8

Molecular formula: C<sub>6</sub>H<sub>14</sub>ClN . BF<sub>4</sub> . H

CAS Index Name: Ethanamine, 2-chloro-N,N-diethyl-, tetrafluoroborate(1-)(1:1)

**IUPAC name:**

Synonyms:

CM 1  
CRN 16872-11-0 (14874-70-5)  
CMF B F4 . H  
CCl CCS



CM 2  
CRN 100-35-6  
CMF C6 H14 Cl N





**Chemical name:** 2-(N,N-Diethylamino)ethylchloride,  
Hexafluorophosphate and Hydrogen(H+) (1:1:1)

Schedule: 2B10

CAS RN: 1255381-67-9 HS code: 2921.19

Key: 1255381-67-9

Molecular formula: C6H14ClN . F6P . H

CAS Index Name: Phosphate(1-), hexafluoro-, hydrogen, compd. with 2-chloro-N,N-diethylethanamine (1:1:1)

**IUPAC name:**

Synonyms:

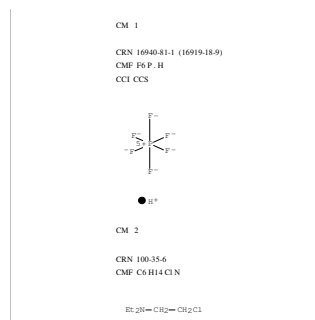

**Chemical name:** 2-(N,N-Diethyl(d10)amino)ethyl(d5)chloride

Schedule: 2B10

CAS RN: 1469441-30-2 HS code: 2845.90

Key: 1469441-30-2

Molecular formula: C6CID14N

CAS Index Name: Ethan-1,1,2,2,2-d5-amine, N-(2-chloroethyl-1,1,2,2-d4)-N-(ethyl-1,1,2,2,2-d5)-

**IUPAC name:**

Synonyms:

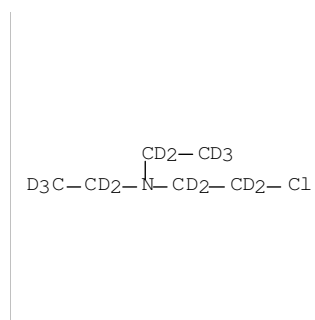

**Chemical name:** 2-(N,N-Dipropylamino)ethylchloride

Schedule: 2B10

CAS RN: 36716-60-6 HS code: 2921.19

Key: 36716-60-6

Molecular formula: C8H18ClN

CAS Index Name: 1-Propanamine, N-(2-chloroethyl)-N-propyl-

**IUPAC name:** N-(2-chloroethyl)-N-propylpropan-1-amine

Synonyms: N-(2-chloroethyl)-N,N-dipropylamine

N,N-Dipropylaminoethyl-2-chloride

N,N-Dipropyl-2-chloroethylamine

Dipropylamine, N-(2-chloroethyl)-

2-(Dipropylamino)ethylchloride

(2-Chloroethyl)dipropylamine

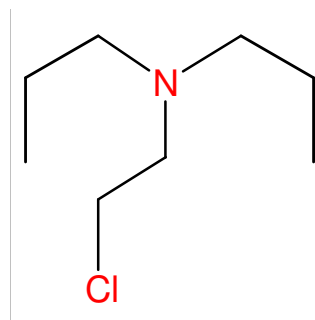

**Chemical name:** 2-(N-Isopropyl-N-methylamino)ethylchloride

Schedule: 2B10

CAS RN: 408326-30-7

HS code: 2921.19

Key: 408326-30-7

Molecular formula: C<sub>6</sub>H<sub>14</sub>ClN

CAS Index Name: 2-Propanamine, N-(2-chloroethyl)-N-methyl-

**IUPAC name:** N-(2-chloroethyl)-N-methylpropan-2-amine

Synonyms: NSC 211447

N-Methyl-N-isopropylaminoethyl-2-chloride

N-Methyl-N-1-methylethylaminoethyl-2-chloride

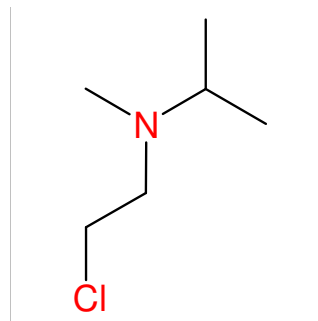

**Chemical name:** 2-(N,N-Diisopropylamino)ethylchloride hydrochloride

Schedule: 2B10

CAS RN: 4261-68-1

HS code: 2921.14

Key: 4261-68-1

Molecular formula: C<sub>8</sub>H<sub>18</sub>ClN.HCl

CAS Index Name: 2-Propanamine, N-(2-chloroethyl)-N-(1-methylethyl)-, hydrochloride

**IUPAC name:** N-(2-Chloroethyl)-N-isopropylpropan-2-aminium chloride

Synonyms: Triethylamine, 2''-chloro-1,1'-dimethyl-, hydrochloride

N-(2-Chloroethyl)diisopropylamine hydrochloride

N,N-Diisopropylaminoethyl-2-chloride hydrochloride

2-(Diisopropylamino)ethyl chloride hydrochloride

(β-Chloroethyl)diisopropylamine hydrochloride

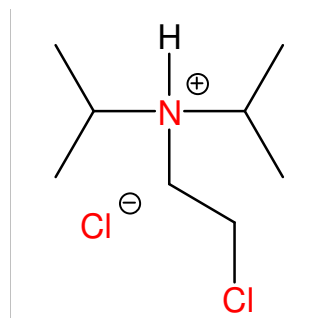

**Chemical name:** 2-(N,N-dipropylamino)ethylchloride hydrochloride (1:1)

Schedule: 2B10

CAS RN: 4535-86-8

HS code: 2921.19

Key: 4535-86-8

Molecular formula: C<sub>8</sub>H<sub>19</sub>Cl<sub>2</sub>N

CAS Index Name: 1-Propanamine, N-(2-chloroethyl)-N-propyl-, hydrochloride (1:1)

**IUPAC name:**

Synonyms:

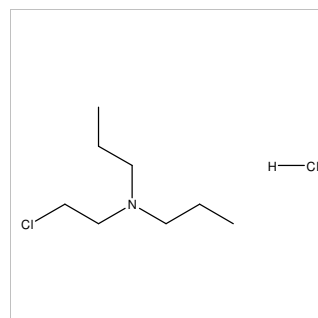

**Chemical name:** 2-(N,N-Dimethylamino)ethylchloride hydrochloride

Schedule: 2B10

CAS RN: 4584-46-7

HS code: 2921.12

Key: 4584-46-7

Molecular formula: C<sub>4</sub>H<sub>11</sub>Cl<sub>2</sub>N

CAS Index Name: Ethanamine, 2-chloro-N,N-dimethyl-, hydrochloride

**IUPAC name:** 2-Chloro-N,N-dimethylethanaminium chloride

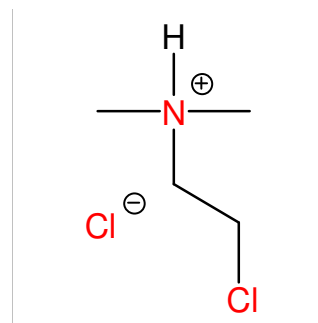

**Synonyms:** Chloroethyldimethylamine hydrochloride

(β-Chloroethyl)dimethylamine-hydrochloride

1-Chloro-2-(dimethylamino)ethane hydrochloride

2-(Dimethylamino)chloroethane hydrochloride

2-(Dimethylamino)ethyl chloride hydrochloride

2-Chloro-N,N-dimethylethanamine hydrochloride

2-Chloro-N,N-dimethylethylamine hydrochloride

2-Chloroethyl dimethyl ammonium chloride

(2-Chloroethyl)dimethylamine hydrochloride

Chloro(dimethylamino)ethane hydrochloride

β-Dimethylaminoethyl chloride hydrochloride

Dimethylaminoethyl chloride hydrochloride

Ethylamine, 2-chloro-N,N-dimethyl-, hydrochloride

N,N-Dimethyl-2-chloroethylamine hydrochloride

N,N-Dimethyl-N-(2-chloroethyl)amine hydrochloride

N,N-Dimethylaminoethyl-2-chloride hydrochloride

N-(2-Chloroethyl)-N,N-dimethylammonium chloride

N-(2-Chloroethyl)dimethylamine hydrochloride

2-Chloroethyldimethylamine monohydrochloride

**Chemical name:** 2-(N-Ethyl-N-methylamino)ethylchloride

Schedule: 2B10

CAS RN: 54153-16-1

HS code: 2921.19

Key: 54153-16-1

Molecular formula: C<sub>5</sub>H<sub>12</sub>ClN

CAS Index Name: Ethanamine, 2-chloro-N-ethyl-N-methyl-

**IUPAC name:**

**Synonyms:**

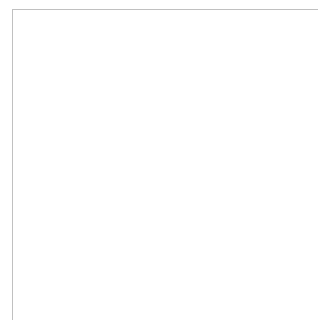

**Chemical name:** 2-(N-Isopropyl-N-propylamino)ethylchloride

Schedule: 2B10

CAS RN: 688299-03-8

HS code: 2921.19

Key: 688299-03-8

Molecular formula: C<sub>8</sub>H<sub>18</sub>ClN

CAS Index Name: 1-Propanamine, N-(2-chloroethyl)-N-(1-methylethyl)-

**IUPAC name:** N-(2-chloroethyl)-N-(isopropyl)propan-1-amine

Synonyms: N-Isopropyl-N-propylaminoethyl-2-chloride

N-(2-chloroethyl)-N-(propan-2-yl)propan-1-amine

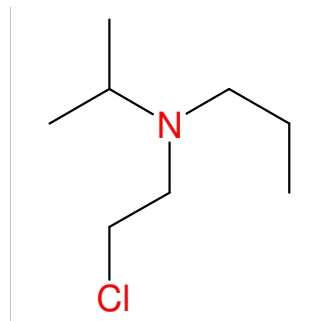

**Chemical name:** 2-(N-Methyl-N-propylamino)ethylchloride

Schedule: 2B10

CAS RN: 763884-48-6

HS code: 2921.19

Key: 763884-48-6

Molecular formula: C<sub>6</sub>H<sub>14</sub>ClN

CAS Index Name: 1-Propanamine, N-(2-chloroethyl)-N-methyl-

**IUPAC name:** N-(2-chloroethyl)-N-methylpropan-1-amine

Synonyms: N-Methyl-N-propylaminoethyl-2-chloride

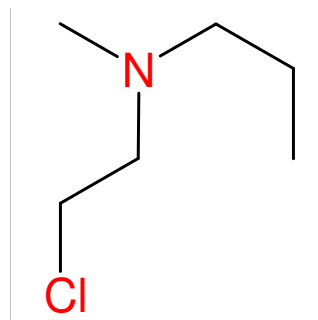

**Chemical name:** 2-(N,N-Diethylamino)ethylchloride hydrochloride

Schedule: 2B10

CAS RN: 869-24-9

HS code: 2921.13

Key: 869-24-9

Molecular formula: C<sub>6</sub>H<sub>15</sub>Cl<sub>2</sub>N

CAS Index Name: Ethanamine, 2-chloro-N,N-diethyl-, hydrochloride

**IUPAC name:** 2-Chloro-N,N-diethylethanaminium chloride

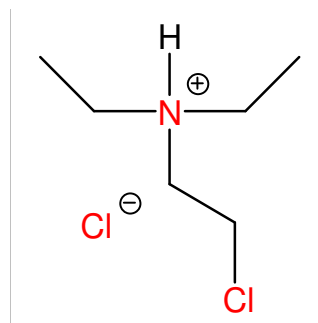

Synonyms: N,N-Diethyl-2-chloroethylamine hydrochloride

1-Chloro-2-(diethylamino)ethane hydrochloride

2-(Diethylamino)ethyl chloride hydrochloric acid salt

2-(Diethylamino)ethyl chloride hydrochloride

2-(N,N-Diethylamino)ethyl chloride hydrochloride

2-Chloro-N,N-diethylethylamine hydrochloride

2-Chloroethyl-N,N-diethylamine hydrochloride

(2-Chloroethyl)diethylamine monohydrochloride

2-Chlorotriethylamine hydrochloride

Triethylamine, 2-chloro-, hydrochloride

N,N-Diethyl-β-chloroethylamine hydrochloride

N,N-Diethylaminoethyl chloride hydrochloride

N-(2-Chloroethyl)diethylamine hydrochloride

N-2-Chloroethyl-N,N-diethylammonium hydrochloride

β-(Diethylamino)ethyl chloride hydrochloride

β-Chloroethyldiethylamine hydrochloride

2-Chloroethyldiethylammonium chloride

**Chemical name:** 2-(N-Ethyl-N-isopropylamino)ethylchloride

Schedule: 2B10

CAS RN: 92204-40-5

HS code: 2921.19

Key: 92204-40-5

Molecular formula: C<sub>7</sub>H<sub>16</sub>ClN

CAS Index Name: 2-Propanamine, N-(2-chloroethyl)-N-ethyl-

**IUPAC name:**

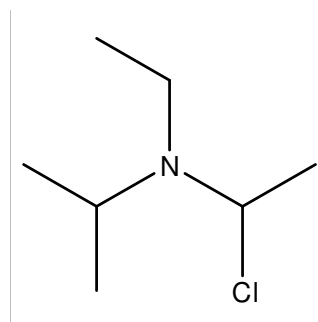

Synonyms:

**Chemical name:** 2-(N,N-Diisopropylamino)ethylchloride

Schedule: 2B10

CAS RN: 96-79-7

HS code: 2921.19

Key: 96-79-7

Molecular formula: C<sub>8</sub>H<sub>18</sub>ClN

CAS Index Name: 2-Propanamine, N-(2-chloroethyl)-N-(1-methylethyl)-

**IUPAC name:** N-(2-Chloroethyl)-N-isopropylpropan-2-amine

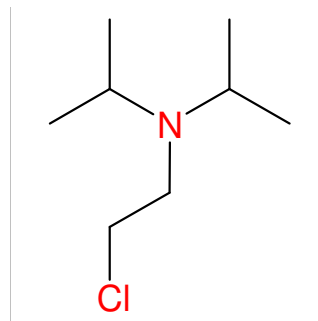

Synonyms: N,N-Diisopropyl-2-chloroethylamine

1-Chloro-2-(diisopropylamino)ethane

2-(Diisopropylamino)ethylchloride

2-(N,N-Diisopropylamino)ethylchloride

2-Chloro-1',1''-dimethyltriethylamine

2-Chloro-bis-(1-methylethyl)aminoethane

1-(Diisopropylamino)-2-chloroethane

2-Chloroethyl-N,N-diisopropylamine

Triethylamine, 2-chloro-1',1''-dimethyl-

N,N-Diisopropylaminoethyl-2-chloride

N-(2-Chloroethyl)-N,N-diisopropylamine

N-(2-Chloroethyl)-N-(1-methylethyl)-2-propanamine

N-(2-Chloroethyl)diisopropylamine

β-(Diisopropylamino)ethylchloride

Triethylamine, 2''-chloro-1,1'-dimethyl-

2-Chloro-N,N-diisopropylethylamine

**Chemical name:** 2-(N-Ethyl(d<sub>5</sub>)-N-methylamino)ethanol hydrochloride

Schedule: 2B11

CAS RN: 1092978-79-4

HS code: 2845.90

Key: 1092978-79-4

Molecular formula: C<sub>5</sub>H<sub>8</sub>D<sub>5</sub>NO . ClH

CAS Index Name: Ethanol, 2-(ethyl-1,1,2,2,2-d<sub>5</sub>-methylamino)-, hydrochloride (1:1)

**IUPAC name:**

Synonyms:

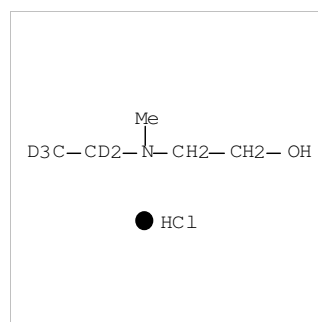

**Chemical name:** 2-(N-propyl-N-propyl(d7)amino)ethanol hydrochloride

Schedule: 2B11

CAS RN: 1092978-81-8

HS code: 2845.90

Key: 1092978-81-8

Molecular formula: C<sub>8</sub>H<sub>12</sub>D<sub>7</sub>NO . ClH

CAS Index Name: Ethanol, 2-(propylpropyl-1,1,2,2,3,3,3-d7-amino)-, hydrochloride (1:1)

**IUPAC name:**

Synonyms:

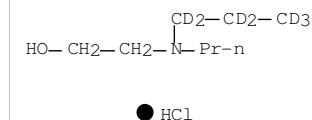

**Chemical name:** 2-(N-Ethyl(d5)-N-methylamino)ethanol

Schedule: 2B11

CAS RN: 1093059-97-2

HS code: 2845.90

Key: 1093059-97-2

Molecular formula: C<sub>5</sub>H<sub>8</sub>D<sub>5</sub>NO

CAS Index Name: Ethanol, 2-(ethyl-1,1,2,2-d5-methylamino)-

**IUPAC name:**

Synonyms:

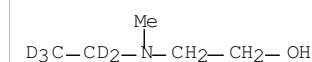

**Chemical name:** 2-(N-Propyl-N-propyl(d7)amino)ethanol

Schedule: 2B11

CAS RN: 1093059-98-3

HS code: 2845.90

Key: 1093059-98-3

Molecular formula: C<sub>8</sub>H<sub>12</sub>D<sub>7</sub>NO

CAS Index Name: Ethanol, 2-(propylpropyl-1,1,2,2,3,3,3-d7-amino)-

**IUPAC name:**

Synonyms:

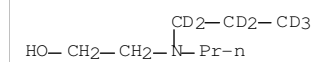

**Chemical name:** 2-(N,N-Diisopropyl(C13)amino)ethanol

Schedule: 2B11

CAS RN: 1313734-90-5

HS code: 2845.90

Key: 1313734-90-5

Molecular formula: C<sub>8</sub>H<sub>19</sub>NO

CAS Index Name: Ethanol, 2- [bis[1-(methyl-13C)ethyl-1,2-13C2]amino]-

**IUPAC name:**

Synonyms:

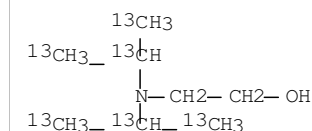

**Chemical name:** 2-(N,N-Diisopropylamino)ethanol and Hydrogen sulfide (1:1)

Schedule: 2B11

CAS RN: 1373773-53-5

HS code: 2922.19

Key: 1373773-53-5

Molecular formula: C<sub>8</sub>H<sub>19</sub>NO . H<sub>2</sub>S

CAS Index Name: Ethanol, 2-[bis(1-methylethyl)amino]-, compd. with hydrogen sulfide (H<sub>2</sub>S) (1:1)

**IUPAC name:**

Synonyms:

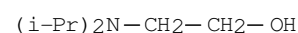

**Chemical name:** Ether of 2-(N,N-Diisopropylamino)ethanol and Dextran (1:1)

Schedule: 2B11

CAS RN: 1392221-32-7

HS code: 2931.39

Key: 1392221-32-7

Molecular formula: C<sub>8</sub> H<sub>19</sub> N O . x Unspecified

CAS Index Name: Dextran, 2-[bis(1-methylethyl)amino]ethyl ether

**IUPAC name:**

Synonyms:

CM 1

CRN 9004-54-0  
CMF Unspecified  
CCI PMS, MAN

\*\*\* STRUCTURE DIAGRAM IS NOT AVAILABLE \*\*\*  
CM 2

CRN 96-80-0  
CMF C<sub>8</sub> H<sub>19</sub> N O

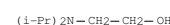

**Chemical name:** 2-(N-Ethyl-N-methylamino)ethanol

Schedule: 2B11

CAS RN: 2893-43-8

HS code: 2922.19

Key: 2893-43-8

Molecular formula: C<sub>5</sub>H<sub>13</sub>NO

CAS Index Name: Ethanol, 2-(ethylmethylamino)-

**IUPAC name:** 2-(Ethylmethylamino)ethanol

Synonyms: N-Ethyl-N-methylethanolamine  
N-Ethyl,N-methylaminoethane-2-ol  
Ethylmethylethanolamine  
Ethylmethylaminoethanol  
2-(N-Ethyl,N-methyl)ethanolamine

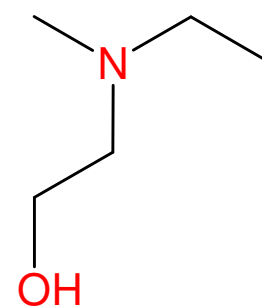



**Chemical name:** 2-(N-Methyl-N-propylamino)ethanol

Schedule: 2B11

CAS RN: 2893-45-0

HS code: 2922.19

Key: 2893-45-0

Molecular formula: C<sub>6</sub>H<sub>15</sub>NO

CAS Index Name: Ethanol, 2-(methylpropylamino)-

**IUPAC name:** 2-(Methylpropylamino)ethanol

Synonyms: N-Methyl-N-propylethanolamine

N-Methyl, N-propylaminoethane-2-ol

2-(N-Methyl-N-propyl)ethanolamine

2-(N-Methyl,N-propyl)ethanolamine

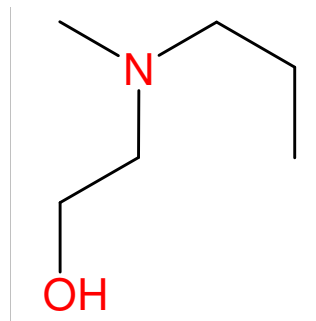

**Chemical name:** 2-(N-Ethyl-N-propylamino)ethanol

Schedule: 2B11

CAS RN: 2893-56-3

HS code: 2922.19

Key: 2893-56-3

Molecular formula: C<sub>7</sub>H<sub>17</sub>NO

CAS Index Name: Ethanol, 2-(ethylpropylamino)-

**IUPAC name:** 2-(Ethylpropylamino)ethanol

Synonyms: N-Ethyl-N-propylethanolamine

N-Ethyl,N-propylaminoethane-2-ol

2-(N-Ethyl,N-propyl)ethanolamine

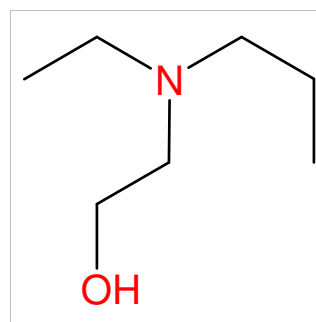

**Chemical name:** 2-(N-Ethyl-N-isopropylamino)ethanol

Schedule: 2B11

CAS RN: 2893-61-0

HS code: 2922.19

Key: 2893-61-0

Molecular formula: C<sub>7</sub>H<sub>17</sub>NO

CAS Index Name: Ethanol, 2-[ethyl(1-methylethyl)amino]-

**IUPAC name:** 2-(Ethylisopropylamino)ethanol

Synonyms: N-Ethyl-N-isopropylaminoethane-2-ol

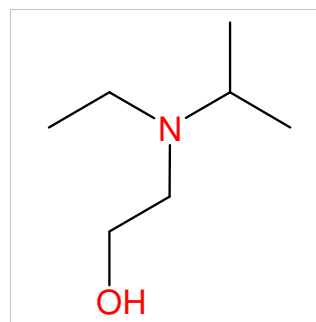

**Chemical name:** 2-(N,N-Dipropylamino)ethanol

Schedule: 2B11

CAS RN: 3238-75-3

HS code: 2922.19

Key: 3238-75-3

Molecular formula: C<sub>8</sub>H<sub>19</sub>NO

CAS Index Name: Ethanol, 2-(dipropylamino)-

**IUPAC name:** 2-(Dipropylamino)ethanol

Synonyms: N,N-Dipropylethanolamine

N,N-Dipropylaminoethane-2-ol

Dipropylethanolamine

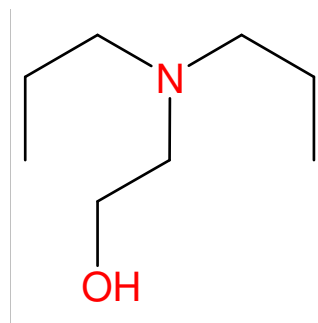

**Chemical name:** 2-(N-Isopropyl-N-propylamino)ethanol

Schedule: 2B11

CAS RN: 4535-77-7

HS code: 2922.19

Key: 4535-77-7

Molecular formula: C<sub>8</sub>H<sub>19</sub>NO

CAS Index Name: Ethanol2-(1-methylethyl)propylamino]-

**IUPAC name:**

Synonyms: Ethanol2-[(1-methylethyl)propylamino]-

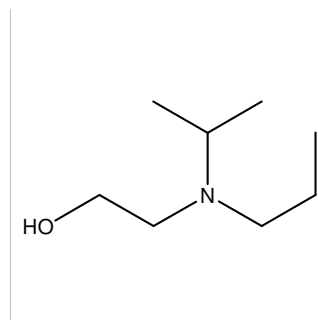

**Chemical name:** 2-(N,N-Diisopropylamino)ethanol

Schedule: 2B11

CAS RN: 96-80-0

HS code: 2922.18

Key: 96-80-0

Molecular formula: C<sub>8</sub>H<sub>19</sub>NO

CAS Index Name: Ethanol, 2-[bis(1-methylethyl)amino]-

**IUPAC name:** 2-Diisopropylaminoethanol

Synonyms: N,N-Diisopropylethanolamine

N,N-Diisopropylaminoethane-2-ol

N,N-Diisopropyl-2-aminoethanol

Ethanol, 2-(diisopropylamino)-

2-(Diisopropylamino)ethyl alcohol

2-(Diisopropylamino)ethanol

(N,N-Diisopropylamino)ethanol

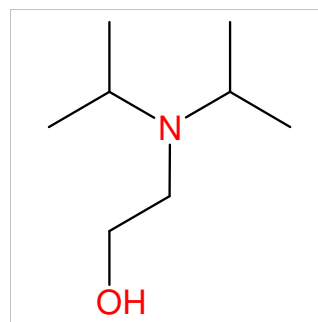

**Chemical name:** 2-(N,N-Diethylamino)ethanethiol

Schedule: 2B12

CAS RN: 100-38-9

HS code: 2930.60

Key: 100-38-9

Molecular formula: C<sub>6</sub>H<sub>15</sub>NS

CAS Index Name: Ethanethiol, 2-(diethylamino)-

**IUPAC name:** 2-(Diethylamino)ethanethiol

Synonyms: N,N-Diethylcysteamine

N,N-Diethylaminoethane-2-thiol

Diethylcysteamine

Diethyl(2-mercaptoethyl)amine

2-N,N-(Diethylamino)ethanethiol

2-(Diethylamino)ethyl mercaptan

2-(Diethylamino)ethyl hydrosulfide

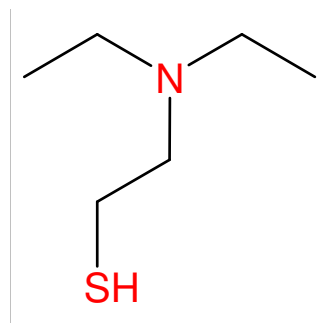

**Chemical name:** 2-(N-Ethyl-N-methylamino)ethanethiol hydrochloride

Schedule: 2B12

CAS RN: 1017861-21-0

HS code: 2930.90

Key: 1017861-21-0

Molecular formula: C<sub>5</sub>H<sub>14</sub>CINS

CAS Index Name: Ethanethiol, 2-(ethylmethylamino)-, hydrochloride (1:1)

**IUPAC name:**

Synonyms:

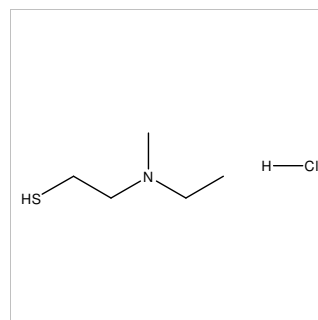

**Chemical name:** 2-(N-Methyl-N-propylamino)ethanethiol hydrochloride

Schedule: 2B12

CAS RN: 1017861-26-5

HS code: 2930.90

Key: 1017861-26-5

Molecular formula: C<sub>6</sub>H<sub>16</sub>CINS

CAS Index Name: Ethanethiol, 2-(methylpropylamino)-, hydrochloride (1:1)

**IUPAC name:**

Synonyms:

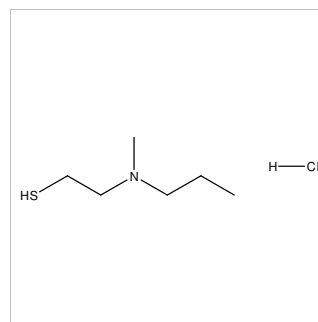

**Chemical name:** 2-(N-Isopropyl-N-methylamino)ethanethiol hydrochloride

Schedule: 2B12

CAS RN: 1017861-29-8

HS code: 2930.90

Key: 1017861-29-8

Molecular formula: C<sub>6</sub>H<sub>16</sub>CINS

CAS Index Name: Ethanethiol, 2-[methyl(1-methylethyl)amino]-, hydrochloride (1:1)

**IUPAC name:**

Synonyms:

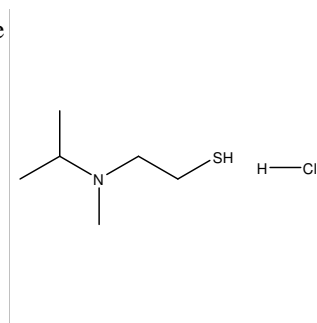

**Chemical name:** 2-(N-Ethyl-N-propylamino)ethanethiol hydrochloride

Schedule: 2B12

CAS RN: 1017861-34-5

HS code: 2930.90

Key: 1017861-34-5

Molecular formula: C<sub>7</sub>H<sub>18</sub>CINS

CAS Index Name: Ethanethiol, 2-(ethylpropylamino)-, hydrochloride (1:1)

**IUPAC name:**

Synonyms:

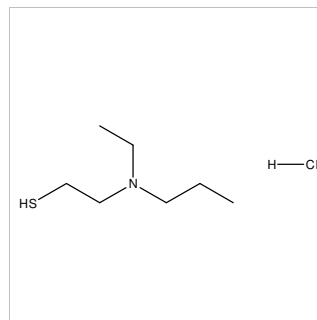

**Chemical name:** 2-(N-Ethyl-N-isopropylamino)ethanethiol hydrochloride

Schedule: 2B12

CAS RN: 1017861-37-8

HS code: 2930.90

Key: 1017861-37-8

Molecular formula: C<sub>7</sub>H<sub>18</sub>CINS

CAS Index Name: Ethanethiol, 2-[ethyl(1-methylethyl)amino]-, hydrochloride (1:1)

**IUPAC name:**

Synonyms:

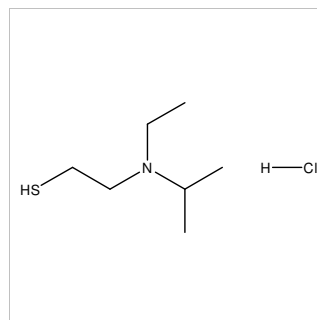

**Chemical name:** 2-(N-Isopropyl-N-propylamino)ethanethiol hydrochloride

Schedule: 2B12

CAS RN: 1017861-45-8

HS code: 2930.90

Key: 1017861-45-8

Molecular formula: C<sub>8</sub>H<sub>20</sub>CINS

CAS Index Name: Ethanethiol, 2-[(1-methylethyl)propylamino]-, hydrochloride (1:1)

**IUPAC name:**

Synonyms:

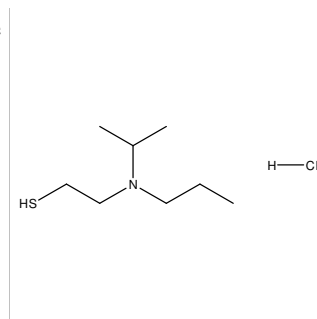

**Chemical name:** 2-(N-Methyl-N-propylamino)ethanethiol

Schedule: 2B12

CAS RN: 1018124-38-3

HS code: 2930.90

Key: 1018124-38-3

Molecular formula: C<sub>6</sub>H<sub>15</sub>NS

CAS Index Name: Ethanethiol, 2-(methylpropylamino)-

**IUPAC name:**

Synonyms:

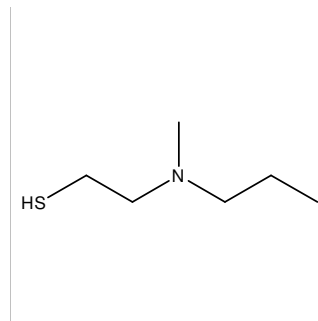

**Chemical name:** 2-(N-Ethyl-N-propylamino)ethanethiol

Schedule: 2B12

CAS RN: 1018124-39-4

HS code: 2930.90

Key: 1018124-39-4

Molecular formula: C<sub>7</sub>H<sub>17</sub>NS

CAS Index Name: Ethanethiol, 2-(ethylpropylamino)-

**IUPAC name:** 2-(Ethylpropylamino)ethanethiol

Synonyms: N-Ethyl-N-propylaminoethane-2-thiol

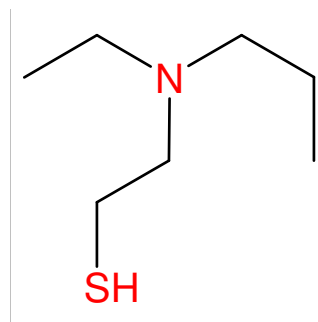

**Chemical name:** 2-(N,N-Dimethylamino)ethanethiol

Schedule: 2B12

CAS RN: 108-02-1

HS code: 2930.90

Key: 108-02-1

Molecular formula: C<sub>4</sub>H<sub>11</sub>NS

CAS Index Name: Ethanethiol, 2-(dimethylamino)-

**IUPAC name:** 2-(Dimethylamino)ethanethiol

Synonyms: N-(2-Mercaptoethyl)-N,N-dimethylamine

N,N-Dimethylcysteamine

N,N-Dimethylaminoethane-2-thiol

Captamine

2-Mercapto-N,N-dimethylaminoethane

(Dimethylamino)ethyl mercaptan

(2-Mercaptoethyl)dimethylamine

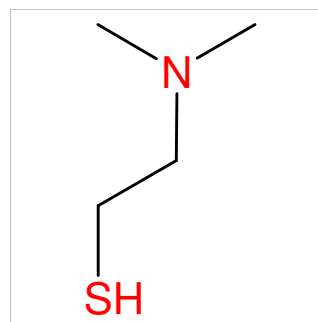

**Chemical name:** 2-(N,N-Dimethyl(d6)amino)ethanethiol hydrochloride

Schedule: 2B12

CAS RN: 1092978-97-6

HS code: 2845.90

Key: 1092978-97-6

Molecular formula: C<sub>4</sub>H<sub>5</sub>D<sub>6</sub>NS . ClH

CAS Index Name: Ethanethiol, 2-[di(methyl-d3)amino]-, hydrochloride (1:1)

**IUPAC name:**

Synonyms:

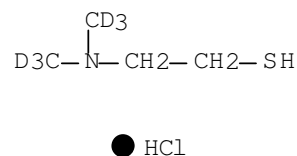

**Chemical name:** 2-(N,N-Diethyl(d10)amino)ethanethiol hydrochloride

Schedule: 2B12

CAS RN: 1092979-00-4

HS code: 2845.90

Key: 1092979-00-4

Molecular formula: C<sub>6</sub>H<sub>5</sub>D<sub>10</sub>NS . ClH

CAS Index Name: Ethanethiol, 2-[di(ethyl-1,1,2,2,2-d5)amino]-, hydrochloride (1:1)

**IUPAC name:**

Synonyms:

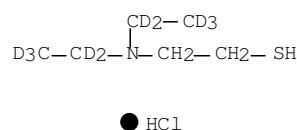

**Chemical name:** 2-(N-ethyl(d5)-N-methylamino)ethanethiol hydrochloride

Schedule: 2B12

CAS RN: 1092979-02-6

HS code: 2845.90

Key: 1092979-02-6

Molecular formula: C<sub>5</sub>H<sub>8</sub>D<sub>5</sub>NS . ClH

CAS Index Name: Ethanethiol, 2-(ethyl-1,1,2,2,2-d5-methylamino)-, hydrochloride (1:1)

**IUPAC name:**

Synonyms:

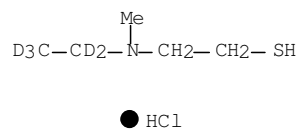

**Chemical name:** 2-(N-propyl(d7)-N-propylamino)ethanethiol hydrochloride

Schedule: 2B12

CAS RN: 1092979-05-9

HS code: 2845.90

Key: 1092979-05-9

Molecular formula: C<sub>8</sub>H<sub>12</sub>D<sub>7</sub>NS . ClH

CAS Index Name: Ethanethiol, 2-(propylpropyl-1,1,2,2,3,3,3-d7-amino)-, hydrochloride (1:1)

**IUPAC name:**

Synonyms:

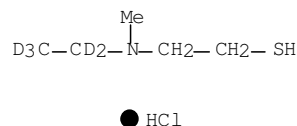

**Chemical name:** 2-(N,N-Diisopropyl(d14)amino)ethanethiol hydrochloride

Schedule: 2B12

CAS RN: 1092979-08-2

HS code: 2845.90

Key: 1092979-08-2

Molecular formula: C<sub>8</sub>H<sub>5</sub>D<sub>14</sub>NS · ClH

CAS Index Name: Ethanethiol, 2-[bis[1-(methyl-d3)ethyl-1,2,2,2-d4]amino]-, hydrochloride (1:1)

**IUPAC name:**

Synonyms:

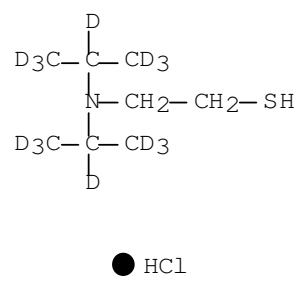

**Chemical name:** 2-(N,N-Dimethyl(d6)amino)ethanethiol

Schedule: 2B12

CAS RN: 1093060-02-6

HS code: 2845.90

Key: 1093060-02-6

Molecular formula: C<sub>4</sub>H<sub>5</sub>D<sub>6</sub>NS

CAS Index Name: Ethanethiol, 2-[di(methyl-d3)amino]-

**IUPAC name:**

Synonyms:

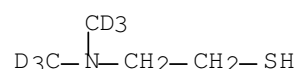

**Chemical name:** 2-(N,N-Diethyl(d10)amino)ethanethiol

Schedule: 2B12

CAS RN: 1093060-03-7

HS code: 2845.90

Key: 1093060-03-7

Molecular formula: C<sub>6</sub>H<sub>5</sub>D<sub>10</sub>NS

CAS Index Name: Ethanethiol, 2-[di(ethyl-1,1,2,2,2-d5)amino]-

**IUPAC name:**

Synonyms:

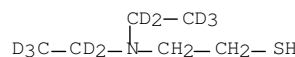

**Chemical name:** 2-(N-Ethyl(d5)-N-methylamino)ethanethiol

Schedule: 2B12

CAS RN: 1093060-04-8

HS code: 2845.90

Key: 1093060-04-8

Molecular formula: C<sub>5</sub>H<sub>8</sub>D<sub>5</sub>NS

CAS Index Name: Ethanethiol, 2-(ethyl-1,1,2,2,2-d5-methylamino)-

**IUPAC name:**

Synonyms:

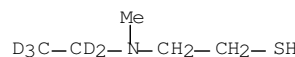

**Chemical name:** 2-(N-Propyl(d7)-N-propylamino)ethanethiol

Schedule: 2B12

CAS RN: 1093060-05-9

HS code: 2845.90

Key: 1093060-05-9

Molecular formula: C<sub>8</sub>H<sub>12</sub>D<sub>7</sub>NS

CAS Index Name: Ethanethiol, 2-(propylpropyl-1,1,2,2,3,3,3-d7-amino)-

**IUPAC name:**

Synonyms:

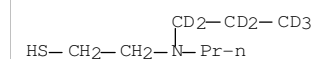

**Chemical name:** 2-(N,N-Diisopropyl(d14)amino)ethanethiol

Schedule: 2B12

CAS RN: 1093060-06-0

HS code: 2845.90

Key: 1093060-06-0

Molecular formula: C<sub>8</sub>H<sub>5</sub>D<sub>14</sub>NS

CAS Index Name: Ethanethiol, 2-[bis[1-(methyl-d3)ethyl-1,2,2,2-d4]amino]-

**IUPAC name:**

Synonyms:

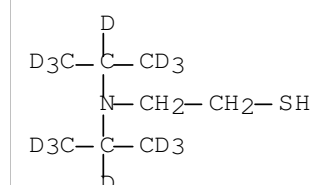

**Chemical name:** 2-(N,N-Dimethylamino)ethanethiol hydrochloride

Schedule: 2B12

CAS RN: 13242-44-9

HS code: 2930.90

Key: 13242-44-9

Molecular formula: C<sub>4</sub>H<sub>12</sub>ClNS

CAS Index Name: Ethanethiol, 2-(dimethylamino)-, hydrochloride

**IUPAC name:** N,N-Dimethyl-2-sulfanylethanaminium chloride

Synonyms: N-(2-Mercaptoethyl)dimethylamine hydrochloride

N,N-Dimethylcysteamine hydrochloride

N,N-Dimethylaminoethane-2-thiol hydrochloride

N,N-Dimethyl-2-thioethanaminium chloride

N,N-Dimethyl-2-aminoethanethiol hydrochloride

MEDA

Captamine hydrochloride

2-Mercapto-N,N-dimethylethanaminium chloride

2-(Dimethylamino)ethanethiol hydrochloride

1-(Dimethylamino)-2-mercaptoethane hydrochloride

(2-Mercaptoethyl)dimethylammonium chloride

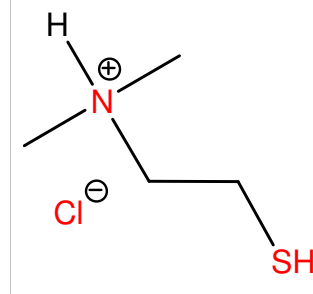



**Chemical name:** 2-(N,N-Diethylamino)ethanethiol hydrochloride

Schedule: 2B12

CAS RN: 1942-52-5

HS code: 2930.90

Key: 1942-52-5

Molecular formula: C<sub>6</sub>H<sub>16</sub>CINS

CAS Index Name: Ethanethiol, 2-(diethylamino)-, hydrochloride

**IUPAC name:** N,N-Diethyl-2-sulfanylethanaminium chloride

Synonyms: N-(2-Mercaptoethyl)diethylamine hydrochloride  
N,N-Diethylaminoethane-2-thiol hydrochloride  
N,N-Diethyl-β-mercaptoethylamine hydrochloride  
N,N-Diethyl-2-mercaptoethanaminium chloride  
Diethylaminoethanethiol hydrochloride  
2-(Diethylamino)ethylmercaptan hydrochloride  
2-(Diethylamino)ethanethiol hydrochloride

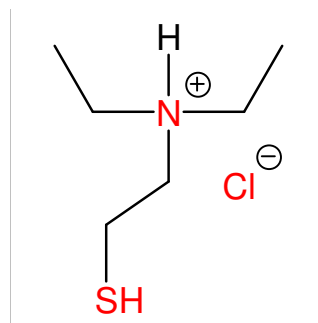

**Chemical name:** 2-(N-Isopropyl-N-methylamino)ethanethiol

Schedule: 2B12

CAS RN: 36759-66-7

HS code: 2930.90

Key: 36759-66-7

Molecular formula: C<sub>6</sub>H<sub>15</sub>NS

CAS Index Name: Ethanethiol, 2-[methyl(1-methylethyl)amino]-

**IUPAC name:**

Synonyms:

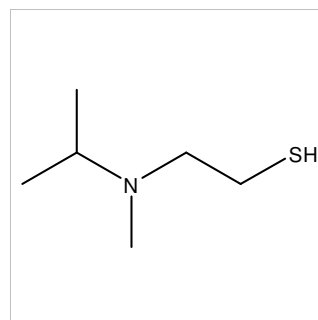

**Chemical name:** 2-(N-Ethyl-N-isopropylamino)ethanethiol

Schedule: 2B12

CAS RN: 36759-67-8

HS code: 2930.90

Key: 36759-67-8

Molecular formula: C<sub>7</sub>H<sub>17</sub>NS

CAS Index Name: Ethanethiol, 2-[ethyl(1-methylethyl)amino]-

**IUPAC name:** 2-(Ethylisopropylamino)ethanethiol

Synonyms: N-Ethyl-N-isopropylaminoethane-2-thiol

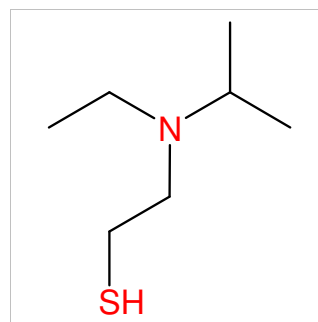

**Chemical name:** 2-(N,N-Diisopropylamino)ethanethiol hydrochloride

Schedule: 2B12

CAS RN: 41480-75-5

HS code: 2930.90

Key: 41480-75-5

Molecular formula: C<sub>8</sub>H<sub>20</sub>CINS

CAS Index Name: 2-Propanamine, N-(1-methylethyl)-N-(2-thioethyl)-, hydrochloride

**IUPAC name:** N-Isopropyl-N-(2-sulfanylethyl)propan-2-aminium chloride

Synonyms: N-Isopropyl-N-(2-mercaptoethyl)propan-2-aminium chloride

N,N-Diisopropylaminoethane-2-thiol hydrochloride

N,N-diisopropyl-2-sulfanylethanaminium chloride

Ethanethiol, 2-[bis(1-methylethyl)amino]-, hydrochloride

Diisopropylaminoethanethiol hydrochloride

2-(Diisopropylamino)ethanethiol hydrochloride

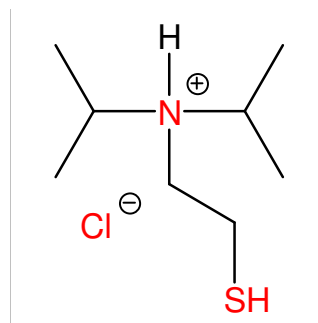

**Chemical name:** 2-(N,N-Dipropylamino)ethanethiol

Schedule: 2B12

CAS RN: 5842-06-8

HS code: 2930.90

Key: 5842-06-8

Molecular formula: C<sub>8</sub>H<sub>19</sub>NS

CAS Index Name: Ethanethiol, 2-(dipropylamino)-

**IUPAC name:** 2-(Dipropylamino)ethanethiol

Synonyms: N,N-Dipropylaminoethane-2-thiol

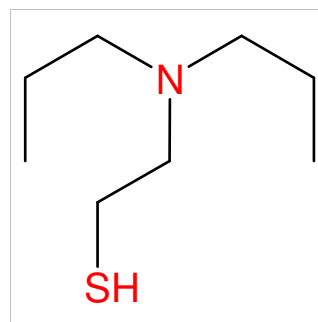

**Chemical name:** 2-(N,N-Diisopropylamino)ethanethiol

Schedule: 2B12

CAS RN: 5842-07-9

HS code: 2930.90

Key: 5842-07-9

Molecular formula: C<sub>8</sub>H<sub>19</sub>NS

CAS Index Name: Ethanethiol, 2-[bis(1-methylethyl)amino]-

**IUPAC name:** 2-(Diisopropylamino)ethanethiol

Synonyms: β-Diisopropylaminoethanethiol

N,N-Diisopropylaminoethane-2-thiol

Ethanethiol, 2-(diisopropylamino)-

Diisopropylaminoethanethiol

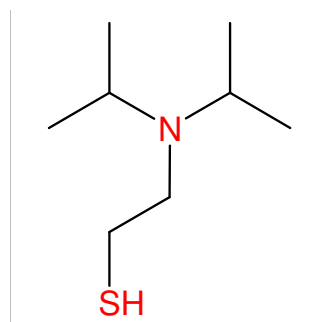

**Chemical name:** 2-(N,N-diethylamino)ethanethiolate sodium

Schedule: 2B12

CAS RN: 58607-68-4

HS code: 2930.90

Key: 58607-68-4

Molecular formula: C<sub>6</sub>H<sub>14</sub>NNaS

CAS Index Name: Ethanethiol, 2-(diethylamino)-, sodium salt (1:1)

**IUPAC name:**

Synonyms:

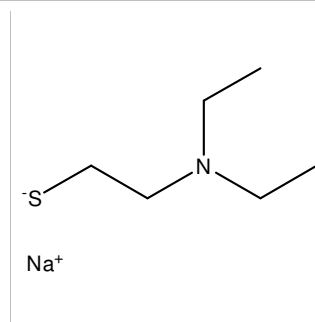

**Chemical name:** 2-(N-Ethyl-N-methylamino)ethanethiol

Schedule: 2B12

CAS RN: 63210-55-9

HS code: 2930.90

Key: 63210-55-9

Molecular formula: C<sub>5</sub>H<sub>13</sub>NS

CAS Index Name: Ethanethiol, 2-(ethylmethylamino)-

**IUPAC name:**

Synonyms:

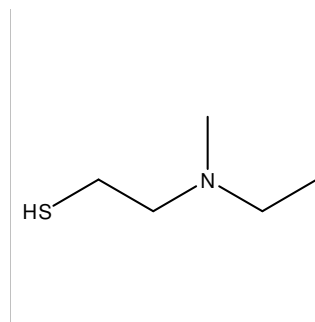

**Chemical name:** Bis(2-hydroxyethyl-C13)sulfide

Schedule: 2B13

CAS RN:

HS code: 2845.90

Key: (111-48-8)-C13

Molecular formula: C<sub>4</sub>H<sub>10</sub>O<sub>2</sub>S

CAS Index Name:

**IUPAC name:**

Synonyms:

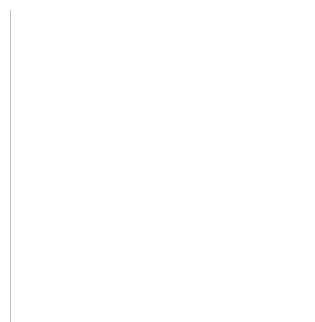

**Chemical name:** Bis(2-hydroxyethyl-d4)sulfide

Schedule: 2B13

CAS RN:

HS code: 2845.90

Key: (111-48-8)-D8

Molecular formula: C<sub>4</sub>H<sub>2</sub>D<sub>8</sub>O<sub>2</sub>S

CAS Index Name: Ethane-1,1,2,2-d<sub>4</sub>, 2,2'-thiobis-

**IUPAC name:** 2,2'-Thiodiethan-d<sub>4</sub>-ol

Synonyms: Octadeuterio thiodiglycol

2,2'-Thiobisethan-d<sub>4</sub>-ol

2,2'-Sulfanediyldi(2H<sub>4</sub>)ethanol

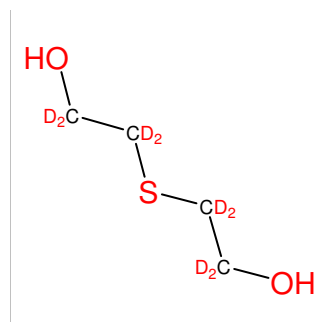

**Chemical name:** Bis(2-hydroxyethyl)sulfide

Schedule: 2B13

CAS RN: 111-48-8

HS code: 2930.70

Key: 111-48-8

Molecular formula: C<sub>4</sub>H<sub>10</sub>O<sub>2</sub>S

CAS Index Name: Ethanol, 2,2'-thiobis-

**IUPAC name:** 2,2'-Thiodiethanol

Synonyms: Ethanol, 2,2'-thiodi-

2,2'-Thiodiglycol

3-Thiapentane-1,5-diol

Bis(2-hydroxyethyl) sulfide

Bis(2-hydroxyethyl) thioether

Bis( $\beta$ -hydroxyethyl) sulfide

2,2'-Thiobisethanol

Diethanol sulfide

Thiodiglycol

Kromfax Solvent

$\beta,\beta'$ -Dihydroxydiethyl sulfide

$\beta,\beta'$ -Dihydroxyethyl sulfide

$\beta$ -Thiodiglycol

Tedegyl

Thiodiethylene glycol

Di(2-hydroxyethyl) sulfide

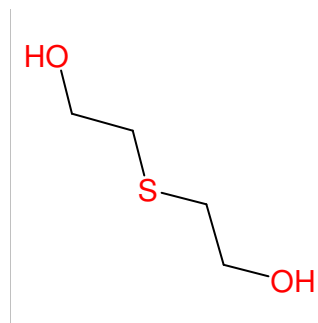

**Chemical name:** 1-14C-2,2-thiobisethanol

Schedule: 2B13

CAS RN: 223129-68-8

HS code: 2845.90

Key: 223129-68-8

Molecular formula: C<sub>4</sub>H<sub>10</sub>O<sub>2</sub>S

CAS Index Name: Ethanol-1-14C, 2-[(2-hydroxyethyl)thio]-

**IUPAC name:**

Synonyms:

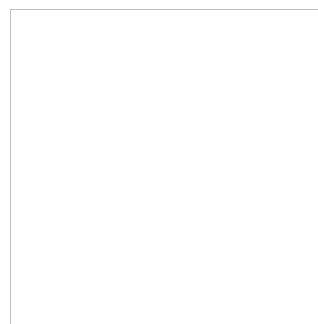

**Chemical name:** 3,3-Dimethyl-2-butanol

Schedule: 2B14

CAS RN: 464-07-3

HS code: 2905.19

Key: 464-07-3

Molecular formula: C<sub>6</sub>H<sub>14</sub>O

CAS Index Name: 2-Butanol, 3,3-dimethyl-

**IUPAC name:** 3,3-Dimethylbutan-2-ol

Synonyms: tert-Butyl methyl carbinol

Pinacolyl alcohol

2,2-Dimethyl-3-butanol

1-Methyl-2,2-dimethylpropanol

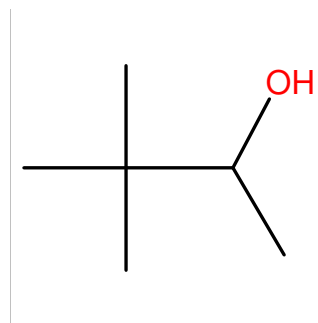

**Chemical name:** Carbonyl dichloride

Schedule: 3A01

CAS RN: 75-44-5

HS code: 2812.11

Key: 75-44-5

Molecular formula: CCl<sub>2</sub>O

CAS Index Name: Carbonic dichloride

**IUPAC name:** Carbonyl dichloride

Synonyms: UN1076

Phosgene

Phosgen

Dichloroformaldehyde

Chloroformyl chloride

CG

Carbonyl chloride

Carbon oxychloride

Carbon dichloride oxide

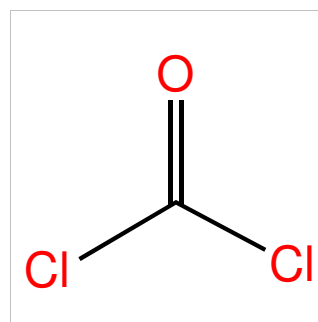

**Chemical name:** Cyanogen chloride

Schedule: 3A02

CAS RN: 506-77-4

HS code: 2853.10

Key: 506-77-4

Molecular formula: CCIN

CAS Index Name: Cyanogen chloride ((CN)Cl)

**IUPAC name:** Cyanogen chloride

Synonyms: UN1589 (Cyanogen chloride stabilized)

Cyanochloride

Chlorocyanogen

Chlorocyanide

Chlorocyan

Chlorine cyanide

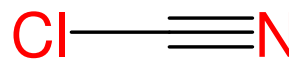

---

**Chemical name:** Hydrogen cyanide

Schedule: 3A03

CAS RN: 74-90-8

HS code: 2811.12

Key: 74-90-8

Molecular formula: HCN

CAS Index Name: Hydrocyanic acid

**IUPAC name:** Nitrilomethane

Synonyms: UN1614 Hydrogen cyanide (STABILIZED)

Prussic acid

Formonitrile

Formic anammonide

Evercyn

Carbon hydride nitride (CHN)

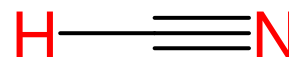

**Chemical name:** Trichloronitromethane

Schedule: 3A04

CAS RN: 76-06-2

HS code: 2904.91

Key: 76-06-2

Molecular formula: CCl<sub>3</sub>NO<sub>2</sub>

CAS Index Name: Methane, trichloronitro-

**IUPAC name:** Trichloro(nitro)methane

Synonyms: UN1580

PS

Picfume

Nitrotrichloromethane

Nitrochloroform

Microlysin

Larvacide

G 25

Chlorpicrin

Chloropicrin

Acquinite

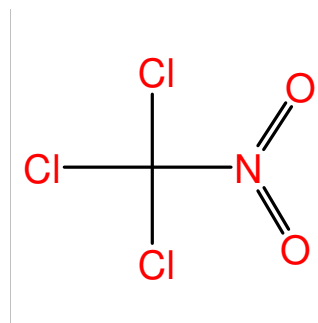

**Chemical name:** Phosphorus oxychloride

Schedule: 3B05

CAS RN: 10025-87-3

HS code: 2812.12

Key: 10025-87-3

Molecular formula: Cl<sub>3</sub>OP

CAS Index Name: Phosphoric trichloride

**IUPAC name:** Phosphoric trichloride

Synonyms: UN1810

Trichlorophosphorus oxide

Trichlorophosphine oxide

Phosphoryl trichloride

Phosphorus trichloride oxide

Phosphorus oxytrichloride

Phosphorus oxide trichloride

Phosphorus monoxide trichloride

Phosphorus chloride oxide

Phosphoroxytrichloride

Phosphoroxychloride

Phosphorous oxychloride

Phosphonyl trichloride

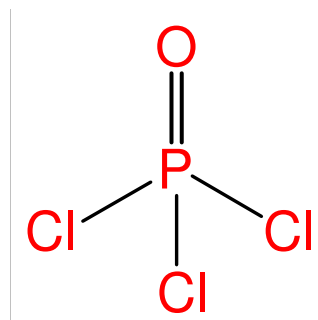

**Chemical name:** Phosphorus trichloride

Schedule: 3B06

CAS RN: 7719-12-2

HS code: 2812.13

Key: 7719-12-2

Molecular formula: Cl<sub>3</sub>P

CAS Index Name: Phosphorus trichloride

**IUPAC name:** Phosphorous trichloride

Synonyms: UN1809

Trichlorophosphine

Phosphorus chloride (PCl<sub>3</sub>)

Phosphorus chloride (Cl<sub>3</sub>P)

Phosphorous chloride

Phosphine, trichloro-

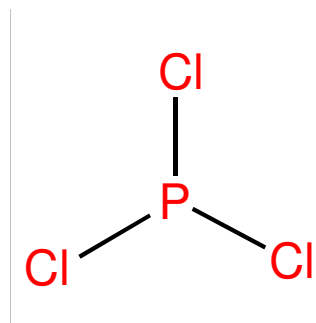

**Chemical name:** Phosphorus pentachloride

Schedule: 3B07

CAS RN: 10026-13-8

HS code: 2812.14

Key: 10026-13-8

Molecular formula: Cl<sub>5</sub>P

CAS Index Name: Phosphorane, pentachloro-

**IUPAC name:** Pentachlorophosphorane

Synonyms: UN1806

Phosphorus perchloride

Phosphorous pentachloride

Pentachlorophosphorus

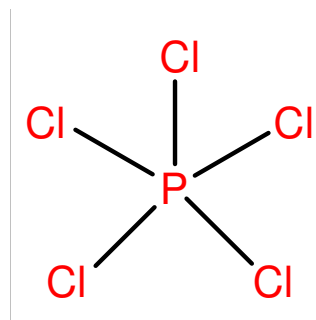

**Chemical name:** Trimethyl phosphite

Schedule: 3B08

CAS RN: 121-45-9

HS code: 2920.23

Key: 121-45-9

Molecular formula: C<sub>3</sub>H<sub>9</sub>O<sub>3</sub>P

CAS Index Name: Phosphorous acid, trimethyl ester

**IUPAC name:** Trimethyl phosphite

Synonyms: UN2329

Trimethoxyphosphine

O,O,O Trimethyl phosphite

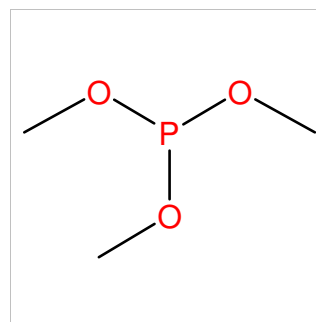



**Chemical name:** Triethyl phosphite

Schedule: 3B09

CAS RN: 122-52-1

HS code: 2920.24

Key: 122-52-1

Molecular formula: C<sub>6</sub>H<sub>15</sub>O<sub>3</sub>P

CAS Index Name: Phosphorous acid, triethyl ester

**IUPAC name:** Triethyl phosphite

Synonyms: UN2323

Tris(ethoxy)phosphine

Triethoxyphosphine

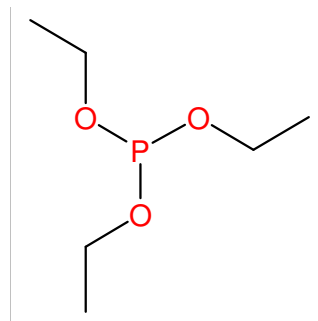

**Chemical name:** Dimethyl phosphite

Schedule: 3B10

CAS RN: 868-85-9

HS code: 2920.21

Key: 868-85-9

Molecular formula: C<sub>2</sub>H<sub>7</sub>O<sub>3</sub>P

CAS Index Name: Phosphonic acid, dimethyl ester

**IUPAC name:** Dimethyl phosphite

Synonyms: Phosphorous acid dimethyl ester

O,O-Dimethyl phosphonate

NCI-C54773

Methyl phosphonate ((MeO)<sub>2</sub>HPO)

Hydrogen dimethyl phosphite

Dimethylester kyseliny fosforite

Dimethyl phosphonate

Dimethyl hydrogen phosphonate

Dimethyl hydrogen phosphite

Dimethyl acid phosphite

Dimethoxyphosphine oxide

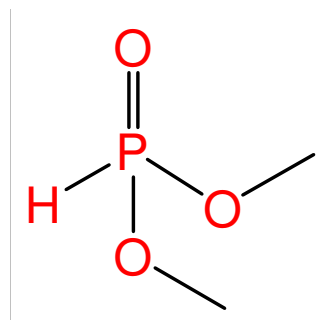

**Chemical name:** Diethyl phosphite

Schedule: 3B11

CAS RN: 762-04-9

HS code: 2920.22

Key: 762-04-9

Molecular formula: C<sub>4</sub>H<sub>11</sub>O<sub>3</sub>P

CAS Index Name: Phosphonic acid, diethyl ester

**IUPAC name:** Diethyl phosphite

Synonyms: Hydrogen diethyl phosphite

Diethyl phosphonate

Diethyl hydrogen phosphite

Diethyl acid phosphite

Diethoxyphosphine oxide

CGI 1700

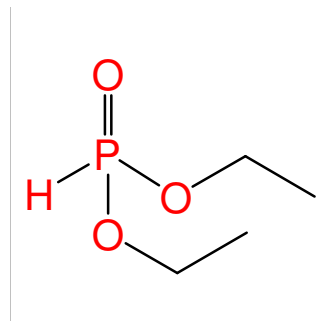

**Chemical name:** Sulfur monochloride

Schedule: 3B12

CAS RN: 10025-67-9

HS code: 2812.15

Key: 10025-67-9

Molecular formula: Cl<sub>2</sub>S<sub>2</sub>

CAS Index Name: Sulfur chloride (S<sub>2</sub>Cl<sub>2</sub>)

**IUPAC name:** Disulfur dichloride

Synonyms: UN1828 (Sulfur chlorides)

Thiosulfurous dichloride

Sulphur chloride (mono)

Sulfur subchloride

Sulfur monochloride

Dichlorodisulfane

Chlorosulfane

Chloride of sulfur

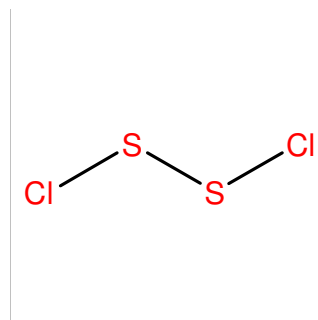

**Chemical name:** Sulfur dichloride

Schedule: 3B13

CAS RN: 10545-99-0

HS code: 2812.16

Key: 10545-99-0

Molecular formula: Cl<sub>2</sub>S

CAS Index Name: Sulfur chloride (SCl<sub>2</sub>)

**IUPAC name:** Sulfur dichloride

Synonyms: UN1828 (Sulfur chlorides)

Sulfur dichloride (SCl<sub>2</sub>)

Monosulfur dichloride

Dichlorosulfane

Chlorine sulfide (Cl<sub>2</sub>S)

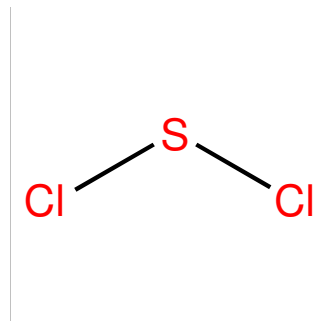

**Chemical name:** Thionyl chloride

Schedule: 3B14

CAS RN: 7719-09-7

HS code: 2812.17

Key: 7719-09-7

Molecular formula: Cl<sub>2</sub>OS

CAS Index Name: Thionyl chloride

**IUPAC name:** Thionyl dichloride

Synonyms: UN1836

Thionyl chloride (SOCl<sub>2</sub>)

Sulfurous oxychloride

Sulfurous dichloride

Sulfur oxychloride (SOCl<sub>2</sub>)

Sulfur oxychloride

Sulfur chloride oxide (SCl<sub>2</sub>O)

Sulfur chloride oxide (Cl<sub>2</sub>SO)

Sulfinyl dichloride

Sulfinyl chloride

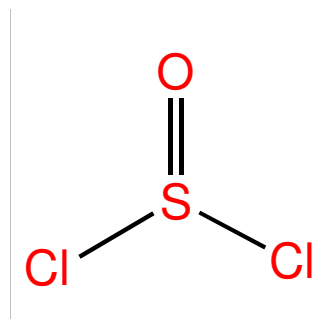

**Chemical name:** Ethyldiethanolamine

Schedule: 3B15

CAS RN: 139-87-7

HS code: 2922.17

Key: 139-87-7

Molecular formula: C<sub>6</sub>H<sub>15</sub>NO<sub>2</sub>

CAS Index Name: Ethanol, 2,2'-(ethylimino)bis-

**IUPAC name:** 2,2'-(Ethylimino)diethanol

Synonyms: N-Ethyldiethanolamine

N-Ethyl-2,2'-iminodiethanol

N,N-Bis(2-hydroxyethyl)ethylamine

Ethylbis(2-hydroxyethyl)amine

Ethanol, 2,2'-(ethylimino)di-

Diethanoethylamine

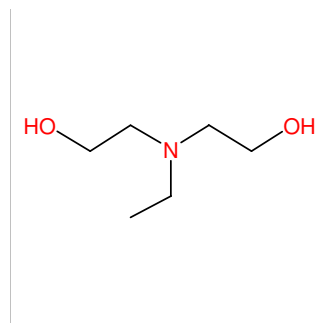

**Chemical name:** Methyldiethanolamine

Schedule: 3B16

CAS RN: 105-59-9

HS code: 2922.17

Key: 105-59-9

Molecular formula: C<sub>5</sub>H<sub>13</sub>NO<sub>2</sub>

CAS Index Name: Ethanol, 2,2'-(methylimino)bis-

**IUPAC name:** 2,2'-(Methylimino)diethanol

Synonyms: N-Methyliminodiethanol

N-Methyldiethanolamine

N-Methylaminodiglycol

N-methyl-2,2'-iminodiethanol

N-(2-Hydroxyethyl)-N-methylethanolamine

N,N-Bis(2-hydroxyethyl)methylamine

Methyliminodiethanol

Methyldiethanolamine

Methylbis(2-hydroxyethyl)amine

MDEA

Eve

Ethanol, 2,2'-(methylimino)di-

Diethanolmethylamine

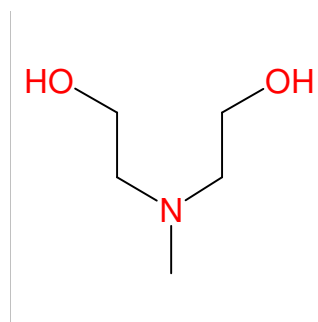

**Chemical name:** Triethanolamine

Schedule: 3B17

CAS RN: 102-71-6

HS code: 2922.15

Key: 102-71-6

Molecular formula: C<sub>6</sub>H<sub>15</sub>NO<sub>3</sub>

CAS Index Name: Ethanol, 2,2',2''-nitrilotris-

**IUPAC name:** 2,2',2''-Nitrilotriethanol

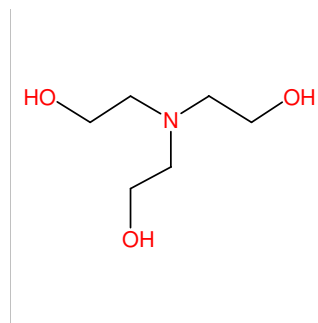

Synonyms: Trolamine

tris-(2-Hydroxyethyl)amine

Tris(beta-hydroxyethyl)amine

Tris(2-hydroxyethyl)amine

Triethanolamin

TEOA

TEA (amino alcohol)

TEA

Sting-Kill

Sterolamide

Nitrilotriethanol

Daltogen

Alkanolamine 244

2,2',2''-Nitrilotris[ethanol]

---